

# Keysight X-Series Signal Analyzer

This manual provides documentation for the following X-Series Analyzers:  
PXA Signal Analyzer N9030A  
MXA Signal Analyzer N9020A  
EXA Signal Analyzer N9010A  
CXA Signal Analyzer N9000A  
EMI Receiver N9038A

EMI Receiver Mode  
User's &  
Programmer's  
Reference

## Notices

© Keysight Technologies, Inc.  
2010-2014

No part of this manual may be reproduced in any form or by any means (including electronic storage and retrieval or translation into a foreign language) without prior agreement and written consent from Keysight Technologies, Inc. as governed by United States and international copyright laws.

## Acknowledgments

Adobe Acrobat® and Reader® are U.S. registered trademarks of Adobe Systems Incorporated.

## Manual Part Number

N6141-90001

## Edition

August 2014

Printed in USA

Keysight Technologies, Inc.  
1400 Fountaingrove Parkway  
Santa Rosa, CA 95403

## Warranty

The material contained in this document is provided “as is,” and is subject to being changed, without notice, in future editions. Further, to the maximum extent permitted by applicable law, Keysight disclaims all warranties, either express or implied, with regard to this manual and any information contained herein, including but not limited to the implied warranties of merchantability and fitness for a particular purpose. Keysight shall not be liable for errors or for incidental or consequential

damages in connection with the furnishing, use, or performance of this document or of any information contained herein. Should Keysight and the user have a separate written agreement with warranty terms covering the material in this document that conflict with these terms, the warranty terms in the separate agreement shall control.

## Technology Licenses

The hardware and/or software described in this document are furnished under a license and may be used or copied only in accordance with the terms of such license.

## Restricted Rights

### Legend

If software is for use in the performance of a U.S. Government prime contract or subcontract, Software is delivered and licensed as “Commercial computer software” as defined in DFAR 252.227-7014 (June 1995), or as a “commercial item” as defined in FAR 2.101(a) or as “Restricted computer software” as defined in FAR 52.227-19 (June 1987) or any equivalent agency regulation or contract clause. Use, duplication or disclosure of Software is subject to Keysight Technologies’ standard commercial license terms, and non-DOD Departments and Agencies of the U.S. Government will receive no greater than Restricted Rights as defined in FAR 52.227-19(c)(1-2) (June 1987). U.S. Government users will

receive no greater than Limited Rights as defined in FAR 52.227-14 (June 1987) or DFAR 252.227-7015 (b)(2) (November 1995), as applicable in any technical data.

## Safety Notices

### CAUTION

A CAUTION notice denotes a hazard. It calls attention to an operating procedure, practice, or the like that, if not correctly performed or adhered to, could result in damage to the product or loss of important data. Do not proceed beyond a CAUTION notice until the indicated conditions are fully understood and met.

### WARNING

A WARNING notice denotes a hazard. It calls attention to an operating procedure, practice, or the like that, if not correctly performed or adhered to, could result in personal injury or death. Do not proceed beyond a WARNING notice until the indicated conditions are fully understood and met.

# Table of Contents

EMI Receiver Mode User's & Programmer's Reference	i
Table of Contents	iii
<b>1 About the Analyzer</b>	<b>47</b>
Installing Application Software	48
Viewing a License Key	48
Obtaining and Installing a License Key	48
Updating Measurement Application Software	48
X-Series Options and Accessories	50
Front-Panel Features	51
Display Annotations	52
Rear-Panel Features	53
Window Control Keys	54
Multi-Window	54
Zoom	54
Next Window	55
Full Screen	56
Display Enable (Remote Command Only)	56
Mouse and Keyboard Control	58
Right-Click	58
PC Keyboard	60
Instrument Security & Memory Volatility	63
<b>2 About the EMI Receiver Measurement Application</b>	<b>65</b>
<b>3 Programming the Analyzer</b>	<b>67</b>
What Programming Information is Available?	68
List of SCPI Commands	69
STATus Subsystem	98
Detailed Description	100
What Are Status Registers	101
What Are Status Register SCPI Commands	101
How to Use the Status Registers	102
Using a Status Register	103
Using the Service Request (SRQ) Method	104
Generating a Service Request	104
Status Register System	105
The Status Byte Register	106
Standard Event Status Register	108
Operation and Questionable Status Registers	110
Operation Status Register	110
Questionable Status Register	110
STATus Subsystem Command Descriptions	111

Operation Register	111
Operation Condition Query	111
Operation Enable	112
Operation Event Query	112
Operation Negative Transition	112
Operation Positive Transition	113
Preset the Status Byte	113
Questionable Register	114
Questionable Condition	114
Questionable Enable	114
Questionable Event Query	115
Questionable Negative Transition	115
Questionable Positive Transition	115
Questionable Calibration Register	116
Questionable Calibration Condition	116
Questionable Calibration Enable	116
Questionable Calibration Event Query	117
Questionable Calibration Negative Transition	117
Questionable Calibration Positive Transition	118
Questionable Calibration Skipped Register	118
Questionable Calibration Skipped Condition	118
Questionable Calibration Skipped Enable	119
Questionable Calibration Skipped Event Query	119
Questionable Calibration Skipped Negative Transition	120
Questionable Calibration Skipped Positive Transition	120
Questionable Calibration Extended Failure Register	120
Questionable Calibration Extended Failure Condition	121
Questionable Calibration Extended Failure Enable	121
Questionable Calibration Extended Failure Event Query	121
Questionable Calibration Extended Failure Negative Transition	122
Questionable Calibration Extended Failure Positive Transition	122
Questionable Calibration Extended Needed Register	123
Questionable Calibration Extended Needed Condition	123
Questionable Calibration Extended Needed Enable	123
Questionable Calibration Extended Needed Event Query	124
Questionable Calibration Extended Needed Negative Transition	124
Questionable Calibration Extended Needed Positive Transition	125
Questionable Frequency Register	125
Questionable Frequency Condition	125
Questionable Frequency Enable	126
Questionable Frequency Event Query	126
Questionable Frequency Negative Transition	126
Questionable Frequency Positive Transition	127

Questionable Integrity Register	127
Questionable Integrity Condition	127
Questionable Integrity Enable	128
Questionable Integrity Event Query	128
Questionable Integrity Negative Transition	129
Questionable Integrity Positive Transition	129
Questionable Integrity Signal Register	129
Questionable Integrity Signal Condition	130
Questionable Integrity Signal Enable	130
Questionable Integrity Signal Event Query	131
Questionable Integrity Signal Negative Transition	131
Questionable Integrity Signal Positive Transition	131
Questionable Integrity Uncalibrated Register	132
Questionable Integrity Uncalibrated Condition	132
Questionable Integrity Uncalibrated Enable	132
Questionable Integrity Uncalibrated Event Query	133
Questionable Integrity Uncalibrated Negative Transition	133
Questionable Integrity Uncalibrated Positive Transition	134
Questionable Power Register	134
Questionable Power Condition	134
Questionable Power Enable	135
Questionable Power Event Query	135
Questionable Power Negative Transition	136
Questionable Power Positive Transition	136
Questionable Temperature Register	136
Questionable Temperature Condition	137
Questionable Temperature Enable	137
Questionable Temperature Event Query	137
Questionable Temperature Negative Transition	138
Questionable Temperature Positive Transition	138
IEEE 488.2 Common Commands	140
All	140
Clear Status	142
Standard Event Status Enable	142
Standard Event Status Register Query	143
Identification Query	143
Operation Complete	144
Query Instrument Options	145
Recall Instrument State	145
*RST (Remote Command Only)	146
Save Instrument State	146
Service Request Enable	146
Status Byte Query	147

Trigger	147
Self Test Query	147
Wait-to-Continue	148
<b>4 Input/Output Functions</b>	<b>149</b>
Input/Output	150
Input/Output variables - Preset behavior	151
RF Input	152
Input Z Correction	152
RF Coupling	153
RF Input Port	154
RF Input	155
RF Input 2	155
RF Preselector	156
I/Q	157
Baseband I/Q (Option BBA)	157
Baseband I/Q Remote Language Compatibility	159
I/Q Path	160
I+jQ	161
I Only	161
Q Only	161
I Setup	162
I Differential Input	162
I Input Z	163
I Skew	164
I Probe	164
Q Setup	166
Q Same as I	166
Q Differential Input	167
Q Input Z	168
Q Skew	168
Q Probe	169
Reference Z	171
I/Q Cable Calibrate...	171
I/Q Probe Setup	172
Attenuation	172
Offset	173
Coupling	174
Calibrate	175
Clear Calibration	175
RF Calibrator	176
50 MHz	177
4.8 GHz	177
Off	177

External Gain	178
Ext Preamp	178
More Information	179
MS	180
BTS	181
I Ext Gain	182
Q Ext Gain	182
Restore Input/Output Defaults	183
Corrections	183
Select Correction	184
Correction On/Off	184
Properties	185
Select Correction	185
Antenna Unit	186
Frequency Interpolation	188
Description	190
Comment	190
Edit	190
Navigate	191
Frequency	192
Amplitude	192
Insert Point Below	192
Delete Point	192
Delete Correction	192
Apply Corrections	193
Delete All Corrections	193
Remote Correction Data Set Commands	194
Set (Replace) Data (Remote Command Only)	194
Merge Correction Data (Remote Command Only)	194
Freq Ref In	195
Sense	197
Internal	197
External	197
Ext Ref Freq	197
External Reference Lock BW	199
Output Config	199
Trig Out	200
Polarity	200
Off	200
Sweeping (HSWP)	201
Measuring	201
Main Trigger	201
Gate Trigger	201

Gate	202
Source Point Trigger	202
Odd/Even Trace Point	202
Analog Out	203
More Information	203
Auto	203
Off	204
Screen Video	204
Demod Audio	205
Digital Bus	206
Bus Out On/Off	206
I/Q Cal Out	206
Aux IF Out	207
Off	207
Second IF	208
I/Q Guided Calibration	208
I/Q Isolation Calibration	208
Next	209
Exit	209
I/Q Isolation Calibration Time (Remote Command Only)	209
I/Q Cable Calibrate...	209
I Port	210
I-bar Port	211
Q Port	212
Q-bar Port	213
I/Q Cable Calibration Time (Remote Command Only)	214
I/Q Probe Calibration	214
I Port	215
I-bar Port	216
Q Port	218
Q-bar Port	219
Show Adapter Screen	220
I/Q Probe Calibration Time (Remote Command Only)	220
Exit Confirmation	220
<b>5 Mode Functions</b>	<b>221</b>
Mode	222
More Information	223
Spectrum Analyzer	224
EMI Receiver	225
IQ Analyzer (Basic)	225
Phase Noise	225
Noise Figure	226
Analog Demod	226



SCPI Language Compatibility	226
89601 VSA	227
Application Mode Number Selection (Remote Command Only)	227
Application Mode Catalog Query (Remote Command Only)	229
Application Identification (Remote Commands Only)	229
Current Application Model	230
Current Application Revision	230
Current Application Options	230
Application Identification Catalog (Remote Commands Only)	231
Application Catalog Number of Entries	231
Application Catalog Model Numbers	231
Application Catalog Revision	231
Application Catalog Options	232
Detailed List of Modes	232
1xEV-DO	232
802.16 OFDMA (WiMAX/WiBro)	233
802.16 OFDM (Fixed WiMAX)	233
89601 VSA	233
Analog Demod	234
Bluetooth	234
cdma2000	235
CMMB	235
Combined WLAN	235
Combined Fixed WiMAX	236
Digital Cable TV	236
DTMB (CTTB)	236
DVB-T/H with T2	237
EMI Receiver	237
GSM/EDGE/EDGE Evo	237
iDEN/WiDEN/MOTOTalk	238
IQ Analyzer (Basic)	238
ISDB-T	238
LTE	238
LTE TDD	239
LTE-Advanced FDD	239
LTE-Advanced TDD	240
MSR	240
Noise Figure	240
Phase Noise	241
Real Time Spectrum Analyzer	241
Remote Language Compatibility	241
SCPI Language Compatibility	242
Spectrum Analyzer	242

TD-SCDMA with HSPA/8PSK	242
Vector Signal Analyzer (VXA)	243
W-CDMA with HSPA+	243
WLAN	243
Global Settings	244
Global Center Freq	244
Restore Defaults	245
Mode Setup	246
EMC Standard	246
Preset To	247
Mode IDN Response	247
Meters Control	248
Meters	248
Select Meters	248
Meter	249
Detector (Meter)	249
Limit	251
Limit Fail? (Remote Command Only)	251
All Limit Fail? (Remote Command Only)	251
Current Power (Remote Query Only)	252
Peak Power (Remote Query Only)	252
Dwell Time (per point)	252
Peak Hold Time	253
Adjustable	253
Infinite	254
Reset Peak Hold	254
Aurorange	254
Aurorange	254
Auto Preamp	255
Couple Meters to Signal List	255
Couple Meters to Marker	256
Aurorange Atten 10 dB Minimum	256
Noise Reduction	257
Noise Floor Extension	257
More Information	258
Global Settings	259
Global Center Freq	259
Global EMC Std	259
Restore Defaults	260
LISN Control	260
V-network	260
Phase	261
Protective Earth	261

V-network	262
Phase	262
150 kHz Highpass	263
V-network	263
Restore Mode Defaults	264
<b>6 System Functions</b>	<b>265</b>
File	266
File Explorer	266
Print	267
Maximize/Restore Down	267
Maximize	267
Restore Down	267
Page Setup	267
Print	268
Restore Down	269
Minimize	269
Exit	270
Print	271
System	272
Show	272
Errors	272
Previous Page	273
Next Page	274
History	274
Verbose SCPI On/Off	274
Refresh	275
Clear Error Queue	275
Status	275
Input Overload Enable (Remote Command Only)	275
System	276
Show System contents (Remote Command Only)	277
Computer System description (Remote Command Only)	277
Hardware	277
LXI	278
System Remote Commands (Remote Commands Only)	278
System Powerdown (Remote Command Only)	279
List installed Options (Remote Command Only)	279
Lock the Front-panel keys (Remote Command Only)	279
List SCPI Commands (Remote Command Only)	280
SCPI Version Query (Remote Command Only)	280
Date (Remote Command Only)	280
Time (Remote Command Only)	281
Power On	281

Mode and Input/Output Defaults	282
User Preset	282
Last State	282
Power On Application	283
Configure Applications	284
Preloading Applications	284
Access to Configure Applications utility	285
Virtual memory usage	285
Select All	285
Deselect All	286
Move Up	286
Move Down	286
Select/Deselect	286
Save Changes and Exit	286
Exit Without Saving	287
Restore Power On Defaults	287
Configure Applications - Instrument boot-up	288
Configure Applications - Windows desktop	288
Configure Applications - Remote Commands	288
Configuration list (Remote Command Only)	289
Configuration Memory Available (Remote Command Only)	289
Configuration Memory Total (Remote Command Only)	289
Configuration Memory Used (Remote Command Only)	289
Configuration Application Memory (Remote Command Only)	290
Alignments	290
Auto Align	290
Normal	291
Partial	292
Off	292
All but RF	293
Alert	293
Execute Expired Alignments (Remote Command Only)	296
Align Now	297
All	297
All but RF	299
RF	300
All but RF Preselector	301
RF Presel Only (20 Hz to 3.6 GHz)	302
Show Alignment Statistics	303
Restore Align Defaults	308
Backup or Restore Align Data...	308
Alignment Data Wizard	309
Perform Backup (Remote Command Only)	314

Perform Restore (Remote Command Only)	315
Advanced	315
Characterize Preselector	315
Characterize Reference Clock	316
Characterize Noise Floor	319
TDS Alignment	321
Timebase DAC	322
Calibrated	322
User	323
RF Preselector	324
Align Now	324
Alert	327
Schedule Setup	328
Scheduler	331
I/O Config	332
GPIB	332
GPIB Address	332
GPIB Controller	333
SCPI LAN	334
SCPI Telnet	334
SCPI Socket	334
SICL Server	335
HiSLIP Server	335
SCPI Socket Control Port (Remote Command Only)	336
Reset Web Password	336
LXI	337
LAN Reset	337
Device Identification (Remote Command Only)	337
System IDN Response	338
Factory	338
User	339
Query USB Connection (Remote Command Only)	339
USB Connection Status (Remote Command Only)	339
USB Packet Count (Remote Command Only)	340
Restore Defaults	340
Restore Input/Output Defaults	341
Restore Power On Defaults	341
Restore Align Defaults	342
Restore Misc Defaults	342
Restore Mode Defaults (All Modes)	343
All	344
Control Panel...	345
Licensing...	346

Security	348
USB	348
Read-Write	348
Read only	348
Diagnostics	349
Show Hardware Statistics	349
SCPI for Show Hardware Statistics ( Remote Commands Only)	350
Query the Mechanical Relay Cycle Count	351
Query the Operating Temperature Extremes	351
Query the Elapsed Time since 1st power on	351
Advanced	352
Internet Explorer...	353
System Remote Commands (Remote Commands Only)	353
System Powerdown (Remote Command Only)	353
List installed Options (Remote Command Only)	354
Lock the Front-panel keys (Remote Command Only)	354
List SCPI Commands (Remote Command Only)	354
SCPI Version Query (Remote Command Only)	355
Date (Remote Command Only)	355
Time (Remote Command Only)	355
<b>7 Trigger Functions</b>	<b>357</b>
Trigger	358
Trigger Source Presets	359
RF Trigger Source	362
I/Q Trigger Source	363
More Information	364
Free Run	365
Video (IF Envelope)	366
Trigger Level	366
Trig Slope	367
Trig Delay	368
External 1	369
Trigger Level	370
Trig Slope	370
Trig Delay	371
Zero Span Delay Comp On/Off	372
External 2	372
Trigger Level	373
Trig Slope	373
Trig Delay	374
Zero Span Delay Comp On/Off	374
Auto/Holdoff	375
Auto Trig	375

Trig Holdoff	376
<b>8 Frequency Scan Measurement</b>	<b>377</b>
AMPTD Y Scale	381
Ref Level	381
Attenuation	381
Scale/ Div	382
Presel Center	383
Proper Preselector Operation	383
Preselector Adjust	384
Y Axis Unit	385
dBm	386
dBmV	387
dBmA	387
W	387
V	387
A	388
dB $\mu$ V	388
dB $\mu$ A	388
dBpW	389
Antenna Unit	389
dB $\mu$ V/m	389
dB $\mu$ A/m	390
dB $\mu$ A	390
dBpT	390
dBG	390
None	391
Ref Level Offset	391
Internal Preamp	391
Off	393
Low Band	393
Full Range	393
Backwards Compatibility SCPI Commands	393
Internal Preamp State (Remote Command Only)	394
Grid Bottom Level (Remote Command Only)	394
Grid Top Level (Remote Command Only)	395
Auto Couple	396
More Information	396
Auto/Man Active Function keys	396
Auto/Man 1-of-N keys	396
BW	398
Res BW	398
Filter BW	399
Cont	401

File	402
FREQ Channel	403
Frequency	403
Midspan Frequency	403
Start Frequency	404
Stop Frequency	405
Freq/ Step	406
Scale Type	407
Input/Output	409
Marker	410
Select Marker	410
Normal	410
Delta	411
Off	411
Properties	411
Select Marker	412
Relative To	412
Marker Trace	412
Couple Markers	413
All Markers Off	413
Marker X Axis Value (Remote Command Only)	414
Marker Y Axis Value (Remote Command Only)	414
Backwards Compatibility SCPI Commands	414
Normal Marker State (Remote Command Only)	415
Normal Marker X Axis Value (Remote Command Only)	415
Normal Marker Y Axis Value (Remote Command Only)	415
Delta Marker State (Remote Command Only)	416
Delta Marker X Axis Value (Remote Command Only)	416
Delta Marker Y Axis Value (Remote Command Only)	416
Marker Function	417
Select Marker	417
Measure at Marker	417
Measure at Marker Window	418
Window On/Off	418
Window Position	418
Detectors (Measure)	419
Select Detector	419
Dwell Time	420
Detector	421
Limit for $\Delta$	421
Center Presel On/Off	422
Marker Zoom	422
Marker Zoom Out	423



Marker To	424
Marker à List	424
Meas at Mkr Result à List	424
Mkr à Meters (Move Meters to Marker Freq)	425
Metersà Mkr (Move Marker to Meters Freq)	425
Meters à Signal (Replace)	425
Meters à List (Append)	425
Snap to Meters (Select Closest Signal)	426
Meas	427
Remote Measurement Functions	427
Measurement Group of Commands	428
Current Measurement Query (Remote Command Only)	430
Limit Test Current Results (Remote Command Only)	430
Data Query (Remote Command Only)	430
Calculate/Compress Trace Data Query (Remote Command Only)	431
Calculate Peaks of Trace Data (Remote Command Only)	436
Format Data: Numeric Data (Remote Command Only)	437
Format Data: Byte Order (Remote Command Only)	438
Meas Setup	439
Select Signal	439
Meas Setup	439
Select Signal	439
Navigate	440
Page Up	440
Page Down	440
Scroll Left	441
Scroll Right	441
Signal à Meters (Move Meters to Current Signal)	441
Mark Signals	441
Select Signal	442
Mark Signal	442
Mark Duplicates	442
Clear Mark	443
Mark All	444
Clear All	444
Delete Signals	444
Select Signal	445
Delete Signal	445
Delete All	446
Delete Marked	446
Delete Unmarked	446
Signal Zoom	447
Zoom Out	447

Sort Signals	448
By Freq	448
By Det Amptd Type	449
By $\Delta$ Detector Type	449
By Time	450
Sort Order	450
Auto Sort	450
Comment	451
Step Control	451
Scan Table	452
Select Range	452
Range State	452
Start Freq	453
Stop Freq	454
Res BW	455
Display Scan Table	456
Dwell Time	457
Step Size	458
Scan Time	460
Scan Points	461
Auto Step Size Rules	462
Points/ RBW	463
Log % of Freq	464
Attenuation	465
Int Preamp	465
Aurorange	467
Auto Preamp	467
RF Input Port	468
Range à SA	469
Range Presets	469
Scan Sequence	471
Continuous	474
Search Only	474
Scan, Search and Measure	474
Scan and Search	475
Search and Measure	475
Remeasure Type	475
Detectors (Measure)	476
Select Detector	477
Dwell Time	477
Detector	478
Limit for $\Delta$	479
Aurorange (Measure)	479

Autorange	479
Auto Preamp	480
# of Scans (Avg Number)	480
Scan Type	481
Time Domain Setup	482
Limits	483
Select Limit	483
Limit On/Off	483
Properties	484
Select Limit	484
Test Trace	484
Interpolation	485
Fixed/ Relative	487
Description	488
Comment	489
Margin	489
Edit Limit	490
Navigate	490
Frequency	490
Amplitude	490
Insert Point Below	491
Delete Point	491
Copy from Limit	491
Build From Trace	492
Offset	492
Scale X Axis	493
Search Criteria	494
Peak Criteria Only	495
Peak Criteria and Limits	495
Subranges and Limits	495
# of Peaks	495
# of Subranges	496
Test Limits (All Limits)	496
Update $\Delta$ Limits	497
Delete Limit	497
Delete All Limits	498
Limit Line Fail? (Remote Command Only)	498
Trace Fail? (Remote Command Only)	499
Limit Line Control (Remote Command Only)	499
Limit Line Upper (Remote Command Only, SCPI standard compatibility)	500
Analog Demod Tune and Listen	501
AM	501
FM	502

De-emphasis (FM Demod Only)	502
$\Phi$ M	503
Off	504
LISN Control (Measure)	504
V-network	504
Settings	505
Phase	505
150 kHz Highpass	505
Protective Earth	506
Meas Preset	506
Mark Signal (Remote Command Only)	507
Clear Mark (Remote Command Only)	507
Delete Signal (Remote Command Only)	507
Range Count (Remote Command Only)	507
Final Measurement (Remote Command Only)	508
Search Method (Remote Command Only)	508
No of Peaks (Remote Command Only)	509
Insert Signal (Remote Command Only)	509
Clear All Signals (Remote Command Only)	509
Mode	510
Mode Preset	511
How-To Preset	512
Mode Setup	514
Peak Search	515
Next Peak	515
Next Peak Right	515
Next Peak Left	516
Min Search	516
Peak Criteria	516
Peak Search Criteria	517
Highest Peak	517
Same as "Next Peak" Criteria	517
Next Peak Criteria	518
Pk Excursion On/Off	518
Pk Threshold On/Off	519
Pk Threshold Line On/Off	519
Print	520
Quick Save	521
Recall	523
State	523
More Information	524
From File...	525
Edit Register Names	526

Register 1 thru Register 16	527
Register 1 thru Register 16	527
Data (Import)	528
Amplitude Correction	529
Default Directory	530
Trace	530
Limit	531
Default Directory	531
Signal List	532
Scan Table	533
Open...	533
State	533
Data (Import)	533
Amplitude Correction	533
Trace	534
Limit	535
Open	536
Restart	537
More Information	537
Save	539
State	539
To File . . .	540
Edit Register Names	542
More Information	542
Register 1 thru Register 16	543
Register 1 thru Register 16	543
Save As . . .	544
Data (Export)	545
Amplitude Correction	545
Correction Data File	546
Trace	548
Frequency Scan Trace File Content	549
Strip Chart Trace File Content	550
Monitor Spectrum Trace File Content	551
Limit	552
Limits File Contents	552
.csv file format	553
.lim file format	554
Signal List	554
Signal List File	554
Scan Table	555
Scan Table File	555
Meas Results	557

Trace	557
Amplitude Correction Display	560
Limits Display State	561
Screen State	561
Scan Table On/Off	562
Signal List On/Off	562
Output Format	562
Save As . . .	563
Screen Image	563
Themes	565
3D Color	565
3D Monochrome	565
Flat Color	565
Flat Monochrome	566
Save As...	566
Mass Storage Catalog (Remote Command Only)	566
Mass Storage Change Directory (Remote Command Only)	567
Mass Storage Copy (Remote Command Only)	567
Mass Storage Device Copy (Remote Command Only)	567
Mass Storage Delete (Remote Command Only)	568
Mass Storage Data (Remote Command Only)	568
Mass Storage Make Directory (Remote Command Only)	568
Mass Storage Move (Remote Command Only)	569
Mass Storage Remove Directory (Remote Command Only)	569
Single	570
Source	571
SPAN X Scale	572
Span	572
Sweep/ Control	573
Continuous/ Single Scan	573
Pause / Resume	573
Start/ Stop	574
Clear List and Start	575
Single (Meters)	575
Continuous (Meters)	576
Restart Meters (Remote Command Only)	576
System	577
Trace/ Detector	578
Select Trace	578
Clear Write	578
Trace Average	578
Max Hold	579
Min Hold	579

View/Blank	580
Trace Update State (Remote Command Only)	581
Trace Display State (Remote Command Only)	581
Detector (Trace)	582
Peak	583
Quasi Peak	583
EMI Average	584
RMS Average	584
Average	584
Negative Peak	585
Copy/Exchange	585
From Trace	585
To Trace	585
Copy Now	586
Exchange Now	586
Send/Query Trace Data (Remote Command Only)	586
Query Trace Data	587
Backwards Compatibility SCPI commands	588
Trace Display (Remote Command Only)	588
Detector Type (Remote Command Only)	588
Trigger	590
Free Run	590
Video	590
Trigger Level	590
Trig Slope	590
Trig Delay	590
External 1	590
Trigger Level	590
Trig Slope	590
Trig Delay	590
Zero Span Delay Comp	590
External 2	590
Trigger Level	590
Trig Slope	590
Trig Delay	591
Zero Span Delay Comp	591
Auto/Holdoff	591
Auto Trig	591
Trig Holdoff	591
User Preset	592
User Preset	592
User Preset All Modes	593
Save User Preset	594

View/ Display	595
Display	595
Annotation	595
Meas Bar On/Off	596
Screen	597
Trace	597
Active Function Values On/Off	597
Title	598
Change Title	598
Clear Title	599
Graticule	600
Display Line	600
System Display Settings	601
Annotation Local Settings	601
Themes	601
Backlight	603
Backlight Intensity	603
Meters Display	603
Meters Freq Line	604
Next Range	604
<b>9 Strip Chart Measurement</b>	<b>605</b>
AMPTD Y Scale	608
Reference Level	608
Attenuation	608
Presel Center	608
Presel Adjust	608
Y Axis Unit	608
Internal Preamp	609
Attenuation	609
Scale/ Div	609
Presel Center	610
Proper Preselector Operation	611
Preselector Adjust	611
Y Axis Unit	612
dBm	614
dBmV	614
dBmA	614
W	615
V	615
A	615
dB $\mu$ V	615
dB $\mu$ A	616
dBpW	616



Antenna Unit	617
dB $\mu$ V/m	617
dB $\mu$ A/m	617
dB $\mu$ A	617
dBpT	618
dBG	618
None	618
Reference Level Offset	619
Internal Preamp	619
Off	620
Low Band	620
Full Range	621
Auto Couple	622
More Information	622
Auto/Man Active Function keys	622
Auto/Man 1-of-N keys	622
BW	624
Res BW	624
Filter BW	625
Cont (Continuous Measurement/Sweep)	627
File	629
FREQ Channel	630
Frequency	630
Freq/ Step	631
Input/Output	632
Marker	633
Select Marker	633
Marker X Axis Value (Remote Command Only)	633
Marker Y Axis Value ( Remote Command Only )	634
Normal	634
Delta	635
Off	635
Marker X Axis Value (Remote Command Only)	635
Marker Y Axis Value ( Remote Command Only )	636
Properties	636
Select Marker	637
Relative To	637
Marker Trace	637
Couple Marker	638
All Marker Off	638
Marker Function	640
Marker Zoom	640
Marker Zoom Out	640

Marker Zoom Out Full	640
Marker To	642
Mkr $\Delta$ ->Span	642
Meas	643
Remote Measurement Functions	643
Measurement Group of Commands	644
Current Measurement Query (Remote Command Only)	646
Limit Test Current Results (Remote Command Only)	646
Data Query (Remote Command Only)	646
Calculate/Compress Trace Data Query (Remote Command Only)	647
Calculate Peaks of Trace Data (Remote Command Only)	652
Format Data: Numeric Data (Remote Command Only)	653
Format Data: Byte Order (Remote Command Only)	654
Meas Setup	655
Analog Demod Tune & Listen	655
AM	655
FM	656
De-emphasis (FM Demod Only)	656
$\Phi$ M	658
Off	658
Limit Fail? (Remote Command Only)	658
Meas Preset	658
Mode	659
Mode Preset	660
How-To Preset	661
Mode Setup	663
Peak Search	664
Next Peak	664
Min Search	664
Print	665
Quick Save	666
Recall	668
State	668
More Information	669
From File...	670
Edit Register Names	671
Register 1 thru Register 16	672
Register 1 thru Register 16	672
Data (Import)	673
Amplitude Correction	674
Default Directory	675
Trace	675
Open...	676

State	676
Data (Import)	676
Amplitude Correction	676
Trace	677
Limit	678
Open	679
Restart	680
More Information	680
Save	682
State	682
To File . . .	683
Edit Register Names	685
More Information	685
Register 1 thru Register 16	686
Register 1 thru Register 16	686
Save As . . .	687
Data (Export)	688
Amplitude Correction	688
Correction Data File	689
Trace	691
Frequency Scan Trace File Content	692
Strip Chart Trace File Content	693
Monitor Spectrum Trace File Content	694
Save As . . .	695
Screen Image	695
Themes	697
3D Color	697
3D Monochrome	697
Flat Color	697
Flat Monochrome	698
Save As...	698
Mass Storage Catalog (Remote Command Only)	698
Mass Storage Change Directory (Remote Command Only)	699
Mass Storage Copy (Remote Command Only)	699
Mass Storage Device Copy (Remote Command Only)	699
Mass Storage Delete (Remote Command Only)	700
Mass Storage Data (Remote Command Only)	700
Mass Storage Make Directory (Remote Command Only)	700
Mass Storage Move (Remote Command Only)	701
Mass Storage Remove Directory (Remote Command Only)	701
Single (Single Measurement/Sweep)	702
More Information	702
Source	703

SPAN X Scale	704
Ref Value	704
Scale/Div	704
Strip Chart Max Duration	705
Full Scale	705
Sweep/Control	706
Stop / Start	706
System	707
Trace/Detector	708
Select Trace	708
Clear Trace	708
Clear All Traces	708
Trigger	710
Free Run	710
Video	710
Trigger Level	710
Trig Slope	710
Trig Delay	710
External 1	710
Trigger Level	710
Trig Slope	710
Trig Delay	710
Zero Span Delay Comp	710
External 2	710
Trigger Level	710
Trig Slope	710
Trig Delay	711
Zero Span Delay Comp	711
Auto/Holdoff	711
Auto Trig	711
Trig Holdoff	711
User Preset	712
User Preset	712
User Preset All Modes	713
Save User Preset	714
View/Display	715
Display	715
Annotation	715
Meas Bar On/Off	716
Screen	717
Trace	717
Active Function Values On/Off	717
Title	718

Change Title	718
Clear Title	719
Graticule	720
System Display Settings	720
Annotation Local Settings	720
Themes	721
Backlight	722
Backlight Intensity	722
Expand Meters	723
Strip Chart View	723
<b>10 Monitor Spectrum Measurement</b>	<b>725</b>
AMPTD Y Scale	730
Reference Level	730
Attenuation	730
Scale/ Div	731
Presel Center	731
Proper Preselector Operation	732
Preselector Adjust	733
Y Axis Unit	734
dBm	735
dBmV	735
dBmA	736
W	736
V	736
A	737
dB $\mu$ V	737
dB $\mu$ A	737
dBpW	738
Antenna Unit	738
dB $\mu$ V/m	738
dB $\mu$ A/m	738
dB $\mu$ A	739
dBpT	739
dBG	739
None	740
Reference Level Offset	740
Internal Preamp	740
Off	741
Low Band	742
Full Range	742
Y Axis Unit	742
Internal Preamp	742
Internal Preamp State (Remote Command Only)	744

Grid Bottom Level (Remote Command Only)	744
Grid Top Level (Remote Command Only)	745
Auto Couple	746
More Information	746
Auto/Man Active Function keys	746
Auto/Man 1-of-N keys	746
BW	748
RBW (Meters)	748
RBW (Spectrum)	749
Cont (Continuous Measurement/Sweep)	751
File	753
FREQ Channel	754
Frequency	754
Freq/ Step	754
CF à Signal (Replace)	755
CF à List (Append)	755
Input/Output	757
Marker	758
Select Marker	758
Normal	758
Delta	759
Off	759
Properties	759
Select Marker	760
Relative To	760
Marker Trace	760
Couple Marker	761
All Markers Off	761
Normal Marker State (Remote Command Only)	762
Normal Marker X Axis Value (Remote Command Only)	762
Normal Marker Y Axis Value (Remote Command Only)	762
Delta Marker State (Remote Command Only)	762
Delta Marker X Axis Value (Remote Command Only)	763
Delta Marker Y Axis Value (Remote Command Only)	763
Marker X Axis Value (Remote Command Only)	763
Marker Y Axis Value ( Remote Command Only )	764
Marker Function	765
Marker->	766
Mkr->CF	766
Meas	767
Remote Measurement Functions	767
Measurement Group of Commands	768
Current Measurement Query (Remote Command Only)	770

Limit Test Current Results (Remote Command Only)	770
Data Query (Remote Command Only)	770
Calculate/Compress Trace Data Query (Remote Command Only)	771
Calculate Peaks of Trace Data (Remote Command Only)	776
Format Data: Numeric Data (Remote Command Only)	777
Format Data: Byte Order (Remote Command Only)	778
Meas Setup	779
Select Signal	779
Signal List	779
Select Signal	779
Navigate	780
Page Up	780
Page Down	780
Scroll Left	780
Scroll Right	781
Signal à Meters (Move Meters to Current Signal)	781
Mark Signals	781
Select Signal	781
Mark Signal	782
Mark Duplicates	782
Clear Mark	783
Mark All	783
Clear All	784
Delete Signals	784
Select Signal	784
Delete Signal	784
Delete All	785
Delete Marked	785
Delete Unmarked	786
Sort Signals	786
By Freq	786
By Detector Amptd	787
By $\Delta$ Detector	787
By Time	788
Sort Order	788
Auto Sort	788
Comment	789
Limits	789
Select Limit	789
Limit On/Off	790
Properties	791
Select Limit	791
Test Trace	791

Interpolation	792
Fixed/ Relative	793
Description	795
Comment	795
Margin	796
Edit Limit	797
Navigate	797
Frequency	797
Amplitude	797
Insert Point Below	797
Delete Point	798
Copy from Limit	798
Build From Trace	798
Offset	799
Scale X Axis	800
Test Limits (All Limits)	801
Delete Limit	801
Delete All Limits	802
Limit Line Fail? (Remote Command Only)	802
Trace Fail? (Remote Command Only)	803
Limit Line Control (Remote Command Only)	803
Limit Line Upper (Remote Command Only, SCPI standard compatibility)	804
Analog Demod Tune & Listen	805
AM	805
FM	805
De-emphasis (FM Demod Only)	806
Off	807
Meas Preset	807
Mode	808
Mode Preset	809
How-To Preset	810
Mode Setup	812
Peak Search	813
Next Peak	813
Next Peak Right	813
Next Peak Left	814
Min Search	814
Peak Criteria	814
Peak Search Criteria	815
Highest Peak	815
Same as “Next Peak” Criteria	815
Next Peak Criteria	816
Pk Excursion On/Off	816



Pk Threshold On/Off	817
Pk Threshold Line On/Off	817
Mkr->CF	818
Marker Delta	818
Peak Search (Remote Command Only)	818
Next Peak (Remote Command Only)	818
Next Peak Right (Remote Command Only)	819
Next Peak Left (Remote Command Only)	819
Delta Peak Search (Remote Command Only)	819
Delta Next Peak (Remote Command Only)	819
Delta Next Peak Right (Remote Command Only)	820
Delta Next Peak Left (Remote Command Only)	820
Delta Min Peak Search (Remote Command Only)	820
Print	821
Quick Save	822
Recall	824
State	824
More Information	825
From File...	826
Edit Register Names	827
Register 1 thru Register 16	828
Register 1 thru Register 16	828
Data (Import)	829
Amplitude Correction	830
Amplitude Correction	831
Default Directory	832
Trace	833
Limit	833
Limit Selection	834
Default Directory	834
Open...	835
Restart	836
More Information	836
Save	838
State	838
To File . . .	839
Edit Register Names	841
More Information	841
Register 1 thru Register 16	842
Register 1 thru Register 16	842
Data (Export)	843
Amplitude Correction	844
Correction Data File	844

Amplitude Correction	847
Trace	847
Frequency Scan Trace File Content	847
Strip Chart Trace File Content	848
Monitor Spectrum Trace File Content	849
Limit	850
Limits File Contents	851
.csv file format	851
.lim file format	852
Save As . . .	852
Screen Image	853
Themes	854
3D Color	855
3D Monochrome	855
Flat Color	855
Flat Monochrome	856
Save As...	856
Mass Storage Catalog (Remote Command Only)	856
Mass Storage Change Directory (Remote Command Only)	857
Mass Storage Copy (Remote Command Only)	857
Mass Storage Device Copy (Remote Command Only)	857
Mass Storage Delete (Remote Command Only)	858
Mass Storage Data (Remote Command Only)	858
Mass Storage Make Directory (Remote Command Only)	858
Mass Storage Move (Remote Command Only)	859
Mass Storage Remove Directory (Remote Command Only)	859
Single (Single Measurement/Sweep)	860
More Information	860
Source	861
SPAN X Scale	862
Span	862
Last Span	863
Sweep/Control	864
Clear List And Restart	864
System	865
Trace/ Detector	866
Trace Annunciator Panel	866
Select Trace	867
Clear Write	867
Trace Average	867
Max Hold	868
Min Hold	869
View/Blank	869

Trace Update State On/Off	870
Trace Display State On/Off	870
More Information	871
Copy Trace 1 To Trace 2	871
Copy Trace 1 To Trace 3	871
Copy Trace (Remote Command Only)	872
Send/Query Trace Data (Remote Command Only)	872
Trace Display (Remote Command Only)	873
Trigger	874
Free Run	874
Video	874
Trigger Level	874
Trig Slope	874
Trig Delay	874
External 1	874
Trigger Level	874
Trig Slope	874
Trig Delay	874
Zero Span Delay Comp	874
External 2	874
Trigger Level	874
Trig Slope	874
Trig Delay	875
Zero Span Delay Comp	875
Auto/Holdoff	875
Auto Trig	875
Trig Holdoff	875
User Preset	876
User Preset	876
User Preset All Modes	877
Save User Preset	878
View/Display	879
Display	879
Annotation	879
Meas Bar On/Off	880
Screen	881
Trace	881
Active Function Values On/Off	881
Title	882
Change Title	882
Clear Title	883
Graticule	884
System Display Settings	884

Annotation Local Settings	884
Themes	885
Backlight	886
Backlight Intensity	886
Expand Meters	887
Freq Scan Graph	887
Meters RBW Lines	888
Example Views	888
<b>11 APD Measurement</b>	<b>893</b>
AMPTD Y Scale	896
Attenuation	896
Autorange	897
Autorange	897
Auto Preamp	897
Presel Center	897
Proper Preselector Operation	898
Preselector Adjust	899
Amplitude Unit	900
dBm	901
dBmV	901
dBmA	902
W	902
V	902
A	902
dB $\mu$ V	903
dB $\mu$ A	903
dBpW	903
Antenna Unit	903
dB $\mu$ V/m	904
dB $\mu$ A/m	904
dB $\mu$ A	904
dBpT	904
dBG	905
None	905
Internal Preamp	905
Off	906
Low Band	907
Full Range	907
$\mu$ W Presel Center	907
$\mu$ W Presel Adjust	907
Auto Couple	908
More Information	908
Auto/Man Active Function keys	908

Auto/Man 1-of-N keys	908
BW	910
Res BW	910
Cont (Continuous Measurement/Sweep)	912
File	914
FREQ Channel	915
Frequency	915
Freq/ Step	915
Freq à Signal (Replace)	916
Freq à List (Append)	916
Input/Output	918
Marker	919
Select Marker	920
Normal	920
Delta	921
Off	921
Properties	921
Select Marker	921
Relative To	921
Marker Trace	922
Couple Markers	922
All Markers Off	923
Backwards Compatibility SCPI Commands	923
Normal Marker State	923
Normal Marker X Axis Value	923
Normal Marker Y Axis Value	924
Delta Marker State	924
Delta Marker X Axis Value	924
Delta Marker Y Axis Value	925
Marker ->	926
Marker à List	926
MarkerFunction	927
Meas	928
Remote Measurement Functions	928
Measurement Group of Commands	929
Current Measurement Query (Remote Command Only)	931
Limit Test Current Results (Remote Command Only)	931
Data Query (Remote Command Only)	931
Calculate/Compress Trace Data Query (Remote Command Only)	932
Calculate Peaks of Trace Data (Remote Command Only)	937
Format Data: Numeric Data (Remote Command Only)	938
Format Data: Byte Order (Remote Command Only)	939
Meas Setup	940

Select Signal	940
Meas Time	940
Measure	941
Limits	941
Select Limit	941
Limit On/Off	942
Properties	942
Select Limit	942
Test Trace	943
Description	943
Comment	944
Edit Limit	944
Navigate	944
Frequency	944
Disturbance Level (E limit)/ Probability of Time (r limit)	945
APD Method	945
Insert Point Below	948
Delete Point	949
Test Limits (All Limits)	949
Delete Limit	949
Delete All Limits	950
Limit Line Fail? (Remote Command Only)	950
Trace Fail? (Remote Command Only)	950
Frequency of Disturbance Level Limit (Remote Command Only)	951
Frequency of Probability Limit (Remote Command Only)	951
Disturbance Level- E limit (Remote Command Only, SCPI standard compatibility)	952
Probability of Time- r limit (Remote Command Only, SCPI standard compatibility)	952
Analog Demod Tune & Listen	953
AM	953
FM	954
De-emphasis (FM Demod Only)	954
PM	955
Off	956
Meas Preset	956
Mode	957
Mode Preset	958
How-To Preset	959
Mode Setup	961
Peak Search	962
Print	963
Quick Save	964

Recall	966
State	966
More Information	967
From File...	968
Edit Register Names	969
Register 1 thru Register 16	970
Register 1 thru Register 16	970
Data (Import)	971
Amplitude Correction	972
Default Directory	973
Trace	973
Limit	974
Default Directory	974
Signal List	975
Open...	975
State	976
Data (Import)	976
Amplitude Correction	976
Trace	976
Limit	977
Open	978
Restart	979
More Information	979
Save	981
State	981
To File . . .	982
Edit Register Names	984
More Information	984
Register 1 thru Register 16	985
Register 1 thru Register 16	985
Data (Export)	986
Amplitude Correction	987
Correction Data File	987
Trace	990
APD Trace File Content	990
Limit	991
APD Limit File Content	991
Signal List	992
APD Signal List File Content	993
Save As . . .	993
Screen Image	994
Themes	995
3D Color	995

3D Monochrome	996
Flat Color	996
Flat Monochrome	996
Save As...	996
Mass Storage Catalog (Remote Command Only)	997
Mass Storage Change Directory (Remote Command Only)	997
Mass Storage Copy (Remote Command Only)	998
Mass Storage Device Copy (Remote Command Only)	998
Mass Storage Delete (Remote Command Only)	998
Mass Storage Data (Remote Command Only)	998
Mass Storage Make Directory (Remote Command Only)	999
Mass Storage Move (Remote Command Only)	999
Mass Storage Remove Directory (Remote Command Only)	1000
Single (Single Measurement/Sweep)	1001
More Information	1001
Source	1002
SPAN X Scale	1003
Reference Level	1003
Scale/Div	1003
Sweep/Control	1005
Pause/Resume	1005
Start Measure/ Stop	1005
System	1008
Trace/Detector	1009
Select Trace	1009
View/Blank	1009
Trace Update State (Remote Command Only)	1010
Trace Display State (Remote Command Only)	1010
Reset Exceeded Limit	1010
Query Trace Data (Remote Command Only)	1011
Trigger	1012
Free Run	1012
Video	1012
Trigger Level	1012
Trig Slope	1012
Trig Delay	1012
External 1	1012
Trigger Level	1012
Trig Slope	1012
Trig Delay	1012
Zero Span Delay Comp	1012
External 2	1012
Trigger Level	1012



Trig Slope	1012
Trig Delay	1013
Zero Span Delay Comp	1013
Auto/Holdoff	1013
Auto Trig	1013
Trig Holdoff	1013
User Preset	1014
User Preset	1014
User Preset All Modes	1015
Save User Preset	1016
View/Display	1017
Display	1017
Annotation	1017
Meas Bar On/Off	1018
Screen	1019
Trace	1019
Active Function Values On/Off	1019
Title	1020
Change Title	1020
Clear Title	1021
Graticule	1022
System Display Settings	1022
Annotation Local Settings	1022
Themes	1023
Backlight	1024
Backlight Intensity	1024
<b>12 Disturbance Analyzer Measurement</b>	<b>1027</b>
AMPTD Y Scale	1031
Reference Level	1031
Scale/ Div	1031
Auto Couple	1033
BW	1034
Cont	1035
File	1036
FREQ Channel	1037
Input/Output	1038
Marker	1039
Select Marker	1039
Normal	1039
Delta	1040
Off	1040
Select Marker	1040
Select Marker	1041

Relative To	1041
Marker Trace	1041
Couple Marker	1042
All Marker Off	1042
Marker X Axis Value (Remote Command Only)	1043
Marker Y Axis Value ( Remote Command Only )	1043
Marker Function	1044
Marker Zoom	1044
Marker Zoom Out	1044
Marker Zoom Out Full	1044
MarkerMarker->	1046
MkrΔ->Span	1046
Meas	1047
Remote Measurement Functions	1047
Measurement Group of Commands	1048
Current Measurement Query (Remote Command Only)	1050
Limit Test Current Results (Remote Command Only)	1050
Data Query (Remote Command Only)	1050
Calculate/Compress Trace Data Query (Remote Command Only)	1051
Calculate Peaks of Trace Data (Remote Command Only)	1056
Format Data: Numeric Data (Remote Command Only)	1057
Format Data: Byte Order (Remote Command Only)	1058
Meas Setup	1059
Select Disturbance	1059
Disturbance List	1059
Select Disturbance	1059
Navigate	1060
Page Up	1060
Page Down	1060
Scroll Left	1060
Scroll Right	1061
Sort Disturbances	1061
By Duration	1061
By Detector Amplitude Type	1061
By Type of Disturbance	1062
By Time	1062
Sort Order	1062
Auto Sort	1063
Delete All	1063
Comment	1063
Zoom	1064
Zoom Out	1064
Setup Table	1064

Frequency	1064
150 kHz	1065
500 kHz	1065
1400 kHz	1065
30 MHz	1066
Manual	1066
Terminal	1066
Limit	1067
Attenuation	1067
Click Rate	1068
Display Setup Table	1069
Duration	1069
Click Correction	1069
Click Count	1070
By $\Delta$ Detector Type	1070
Meas Preset	1071
Mode	1072
Mode Preset	1073
How-To Preset	1074
Mode Setup	1076
Peak Search	1077
Next Peak	1077
Min Search	1077
Print	1078
Quick Save	1079
Recall	1081
State	1081
More Information	1082
From File...	1083
Edit Register Names	1084
Register 1 thru Register 16	1085
Register 1 thru Register 16	1085
Data (Import)	1086
Amplitude Correction	1087
Trace	1088
Disturbance List	1088
Open...	1089
State	1089
Data (Import)	1089
Amplitude Correction	1089
Trace	1090
Limit	1091
Open	1092

## Table of Contents

Restart	1093
More Information	1093
Save	1095
State	1095
To File . . .	1096
Edit Register Names	1098
More Information	1098
Register 1 thru Register 16	1099
Register 1 thru Register 16	1099
Data (Export)	1100
Amplitude Correction	1101
Correction Data File	1101
Amplitude Correction	1104
Trace	1104
Disturbance List	1105
Disturbance Analyzer Meas Result	1106
Edit Header	1107
Meas Setup On/Off	1109
Disturbance List On/Off	1109
Trace (All Traces) On/Off	1109
Screen Image	1110
Themes	1111
3D Color	1111
3D Monochrome	1112
Flat Color	1112
Flat Monochrome	1112
Save As...	1112
Mass Storage Catalog (Remote Command Only)	1113
Mass Storage Change Directory (Remote Command Only)	1113
Mass Storage Copy (Remote Command Only)	1113
Mass Storage Device Copy (Remote Command Only)	1114
Mass Storage Delete (Remote Command Only)	1114
Mass Storage Data (Remote Command Only)	1114
Mass Storage Make Directory (Remote Command Only)	1115
Mass Storage Move (Remote Command Only)	1115
Mass Storage Remove Directory (Remote Command Only)	1115
Single	1117
Source	1118
SPAN X Scale	1119
Ref Value	1119
Scale/Div	1119
Full Scale	1120
Sweep Control	1121

Pause / Resume	1121
Stop / Start	1121
Start Analysis	1122
System	1123
Trace/Detector	1124
Trigger	1125
User Preset	1126
User Preset	1126
User Preset All Modes	1127
Save User Preset	1128
View/Display	1129
Display	1129
Annotation	1129
Meas Bar On/Off	1130
Screen	1131
Trace	1131
Active Function Values On/Off	1131
Title	1132
Change Title	1132
Clear Title	1133
Graticule	1134
System Display Settings	1134
Annotation Local Settings	1134
Themes	1135
Backlight	1136
Backlight Intensity	1136
Normal	1137
Meas Results	1137
Disturbance Indicator Line	1137



## 1 About the Analyzer

The X-Series signal analyzer measures and monitors complex RF and microwave signals. Analog baseband analysis is available on MXA. The analyzer integrates traditional spectrum measurements with advanced vector signal analysis to optimize speed, accuracy, and dynamic range. The analyzer has Windows 7<sup>®</sup> built in as an operating system, which expands its usability.

With a broad set of applications and demodulation capabilities, an intuitive user interface, outstanding connectivity and powerful one-button measurements, the analyzer is ideal for both R&D and manufacturing engineers working on cellular, emerging wireless communications, general purpose, aerospace and defense applications.

## Installing Application Software

If you want to install a measurement application after your initial hardware purchase, you need only to license it. All of the available applications are loaded in your analyzer at the time of purchase.

Thus, when you purchase a new application, you will receive an entitlement certificate that you can use to obtain a license key for that application. To activate the new measurement application, enter the license key that you obtain into the Signal Analyzer.

For the latest information on Keysight Signal Analyzer measurement applications and upgrade kits, visit the following internet URL.

[http://www.agilent.com/find/sa\\_upgrades](http://www.agilent.com/find/sa_upgrades)

### Viewing a License Key

Measurement applications that you purchased with your instrument have been installed and activated at the factory before shipment. The instrument requires a unique License Key for every measurement application purchased. The license key is a hexadecimal string that is specific to your measurement application, instrument model number and serial number. It enables you to install, or reactivate, that particular application.

Press **System, Show, System** to display the measurement applications that are currently licensed in your analyzer.

Go to the following location to view the license keys for the installed measurement applications:

C:\Program Files\Agilent\Licensing

You may want to keep a copy of your license key in a secure location. To do this, you can print out a copy of the display showing the license numbers. If you should lose your license key, call your nearest Keysight Technologies service or sales office for assistance.

### Obtaining and Installing a License Key

If you purchase an additional application that requires installation, you will receive an "Entitlement Certificate", which may be redeemed for a license key for one instrument. To obtain your license key, follow the instructions that accompany the certificate.

Installing a license key for the selected application can be done automatically using a USB memory device. To do this, you copy the license file to the USB memory device, at the root level. Follow the instructions that come with your software installation kit.

Installing a license key can also be done manually using the built-in license management application, which may be found via the instrument front panel keys at **System, Licensing. . .**, or on-disk at:

C:\Programming Files\Agilent\Licensing

You can also use these procedures to reinstall a license key that has been accidentally deleted, or lost due to a memory failure.

### Updating Measurement Application Software

All the software applications were loaded at the time of original instrument manufacture. It is a good idea to regularly update your software with the latest available version. This helps to ensure that you receive



any improvements and expanded functionality.

Because the software was loaded at the initial purchase, further additional measurement applications may now be available. If the application you are interested in licensing is not available, you will need to do a software update. (To display a list of installed applications, press **System, Show, System.**)

Check the appropriate page of the Keysight web site for the latest available software versions, according to the name of your instrument, as follows:

[http://www.agilent.com/find/pxa\\_software](http://www.agilent.com/find/pxa_software)

[http://www.agilent.com/find/mxa\\_software](http://www.agilent.com/find/mxa_software)

[http://www.agilent.com/find/exa\\_software](http://www.agilent.com/find/exa_software)

[http://www.agilent.com/find/cxa\\_software](http://www.agilent.com/find/cxa_software)

You can load the updated software package into the analyzer from a USB drive, or directly from the internet. An automatic loading program is included with the files.

## X-Series Options and Accessories

You can view an online list of available Options and Accessories for your instrument as follows:

1. Browse to one of the following URLs, according to the product name of your analyzer:

[www.agilent.com/find/cxa](http://www.agilent.com/find/cxa)

[www.agilent.com/find/exa](http://www.agilent.com/find/exa)

[www.agilent.com/find/mxa](http://www.agilent.com/find/mxa)

[www.agilent.com/find/pxa](http://www.agilent.com/find/pxa)

2. The home page for your instrument appears (in some cases, you may see an initial splash screen containing a button named View the Webpage, which you should click to display the home page).
3. Locate the Options tab, as highlighted in the example below, which shows the home page for the MXA.



4. Click the Options tab, to display a list of available options and accessories for your instrument.

## Front-Panel Features

The instrument's Front-panel features are fully detailed in the section "Front-Panel Features" (under the chapter "Front and Rear Panel Features") of the document:

### [Getting Started Guide](#)

If you are viewing this information as a Help file in the instrument, then you can click on the link above to open the PDF document.

## Display Annotations

Display Annotations are fully detailed under the chapter "Front and Rear Panel Features" of the document:

[Getting Started Guide](#)

If you are viewing this information as a Help file in the instrument, then you can click on the link above to open the PDF document.

## Rear-Panel Features

The instrument's Rear-panel features are fully detailed in the section "Rear-Panel Features" (under the chapter "Front and Rear Panel Features") of the document:

### [Getting Started Guide](#)

If you are viewing this information as a Help file in the instrument, then you can click on the link above to open the PDF document.

## Window Control Keys

The instrument provides three front-panel keys for controlling windows. They are Multi Window, Zoom, and Next Window. These are all “immediate action” keys.

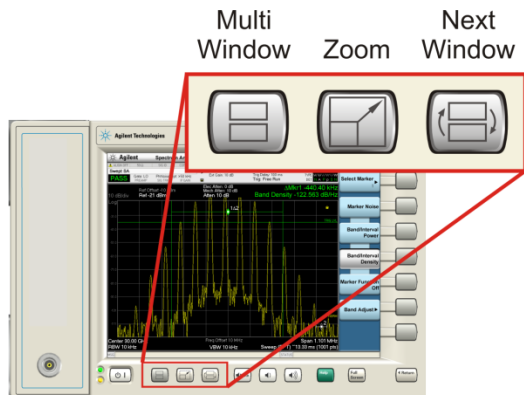

### Multi-Window



The Multi Window front-panel key will toggle you back and forth between the Normal View and the last Multi Window View (Zone Span, Trace Zoom or Spectrogram) that you were in, when using the Swept SA measurement of the Spectrum Analyzer Mode. It remembers which View you were in through a Preset. This “previous view” is set to Zone Span on a Restore Mode Defaults.

---

Key Path	Front-panel key
Initial S/W Revision	Prior to A.02.00

---

### Zoom

Zoom is a toggle function. Pressing this key once increases the size of the selected window. Pressing the key again returns the window to the original size.

When Zoom is on for a window, that window will get the entire primary display area. The zoomed window, since it is the selected window, is outlined in green.

Zoom is local to each Measurement. Each Measurement remembers its Zoom state. The Zoom state of each Measurement is part of the Mode’s state.

**NOTE**

Data acquisition and processing for the other windows continues while a window is zoomed, as does all SCPI communication with the other windows.

---

Remote Command	:DISPlay:WINDow:FORMat:ZOOM
----------------	-----------------------------

---

<b>Remote Command</b>	:DISPlay:WINDow:FORMat:TILE
<b>Example</b>	:DISP:WIND:FORM:ZOOM sets zoomed :DISP:WIND:FORM:TILE sets un-zoomed
<b>Preset</b>	TILE
<b>Initial S/W Revision</b>	Prior to A.02.00

## Next Window

Selects the next window of the current view. When the Next Window key is pressed, the next window in the order of precedence becomes selected. If the selected window was zoomed, the next window will also be zoomed.

The window numbers are as follows. Note that these numbers also determine the order of precedence (that is, Next Window goes from 1 to 2, then 2 to 3, etc.):

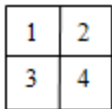

**Four window display**

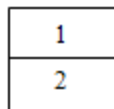

**Two window display**

## RTSA measurements:

Only two windows are available in the Spectrogram view under the Spectrum measurement and up to three windows are available in the Power vs. Time measurement, depending on the view set up.

<b>Remote Command</b>	:DISPlay:WINDow[:SElect] <number> :DISPlay:WINDow[:SElect]?
<b>Example</b>	:DISP:WIND 1
<b>Preset</b>	1
<b>Min</b>	1
<b>Max</b>	If <number> is greater than the number of windows, limit to <number of windows>
<b>Initial S/W Revision</b>	Prior to A.02.00

One and only one window is always selected. The selected window has the focus; this means that all window-specific key presses apply only to that window. You can tell which window is selected by the thick green border around it. If a window is not selected, its boundary is gray.

If a window in a multi-window display is zoomed it is still outlined in green. If there is only one window, the green outline is not used. This allows the user to distinguish between a zoomed window and a display with only one window.

The selected window is local to each Measurement. Each Measurement remembers which window is selected. The selected window for each Measurement is remembered in Mode state.

**NOTE**

When this key is pressed in Help Mode, it toggles focus between the table of contents window and the topic pane window.

## Full Screen

When Full Screen is pressed the measurement window expands horizontally over the entire instrument display. The screen graticule area expands to fill the available display area.

It turns off the display of the softkey labels, however the menus and active functions still work. (Though it would obviously be very hard to navigate without the key labels displayed.) Pressing Full Screen again while Full Screen is in effect cancels Full Screen.

Note that the banner and status lines are unaffected. You can get even more screen area for your data display by turning off the Meas Bar (in the Display menu) which also turns off the settings panel.

Full Screen is a Meas Global function. Therefore it is cancelled by the Preset key.

Key Path	Display
<b>Remote Command</b>	:DISPlay:FSCReen[:STATe] OFF ON 0 1 :DISPlay:FSCReen[:STATe]?
Preset	Unaffected by Preset but set to Off by Restore Misc Defaults or shutdown and restart
State Saved	Not saved in instrument state.
<b>Backwards Compatibility SCPI</b>	:DISPlay:MENU[:STATe] OFF ON 0 1 This emulates ESA full screen functionality, which is the same as the FSCReen command in PSA except that the sense of on/off is reversed (that is, OFF means the menus are OFF, so Fullscreen is ON) and the default is ON (meaning Fullscreen is OFF).
Backwards Compatibility Notes	In ESA/PSA, Full Screen was turned on with a softkey, so pressing any other key turned Full Screen off. In the X-Series, because a hardkey is provided to turn this function on and off, pressing any other key no longer turns off Full Screen
Initial S/W Revision	Prior to A.02.00

## Display Enable (Remote Command Only)

Turns the display on/off, including the display drive circuitry. The backlight stays lit so you can tell that the instrument is on. The display enable setting is mode global. The reasons for turning the display off are three:

- To increase speed as much as possible by freeing the instrument from having to update the display
- To reduce emissions from the display, drive circuitry
- For security purposes

If you have turned off the display:



- and you are in local operation, the display can be turned back on by pressing any key or by sending the SYSTem:DEFaults MISC command or the DISPlay:ENABLE ON (neither \*RST nor SYSTem:PRESet enable the display.)
- and you are in remote operation, the display can be turned back on by pressing the Local or Esc keys or by sending the SYSTem:DEFaults MISC command or the DISPlay:ENABLE ON (neither \*RST nor SYSTem:PRESet enable the display.)

and you are using either the SYSTem:KLOCK command or GPIB local lockout, then no front-panel key press will turn the display back on. You must turn it back on remotely.

<b>Remote Command</b>	:DISPlay:ENABle OFF ON 0 1 :DISPlay:ENABle?
<b>Example</b>	DISP:ENAB OFF
<b>Couplings</b>	DISP:ENAB OFF turns Backlight OFF and DISP:ENAB ON turns Backlight ON. However, settings of Backlight do not change the state of DISP:ENAB
<b>Preset</b>	On Set by SYST:DEF MISC, but Not affected by *RST or SYSTem:PRESet.
<b>State Saved</b>	Not saved in instrument state.
<b>Backwards Compatibility Notes</b>	SYST:PRES no longer turns on DISPlay:ENABle as it did in legacy analyzers
<b>Initial S/W Revision</b>	Prior to A.02.00

## Mouse and Keyboard Control

If you do not have access to the instrument front-panel, there are several ways that a mouse and PC Keyboard can give you access to functions normally accessed using the front-panel keys.

### Right-Click

If you plug in a mouse and right-click on the analyzer screen, a menu will appear as below:

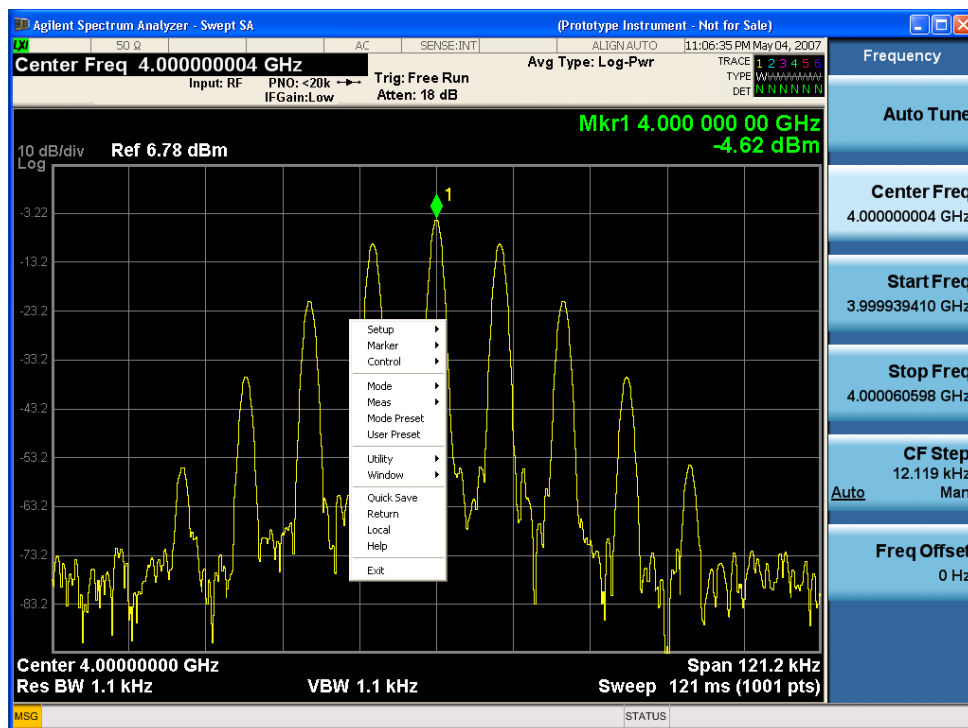

Placing the mouse on one of the rows marked with a right arrow symbol will cause that row to expand, as for example below where the mouse is hovered over the “Utility” row:

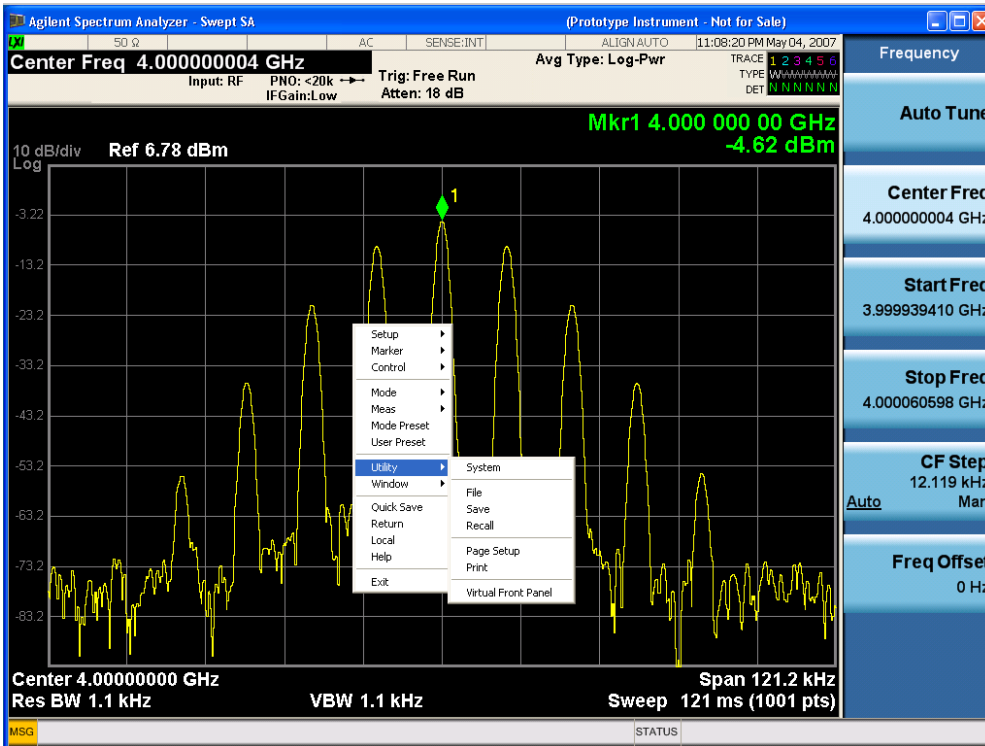

This method can be used to access any of the front-panel keys by using a mouse; as for example if you are accessing the instrument through Remote Desktop.

The array of keys thus available is shown below:

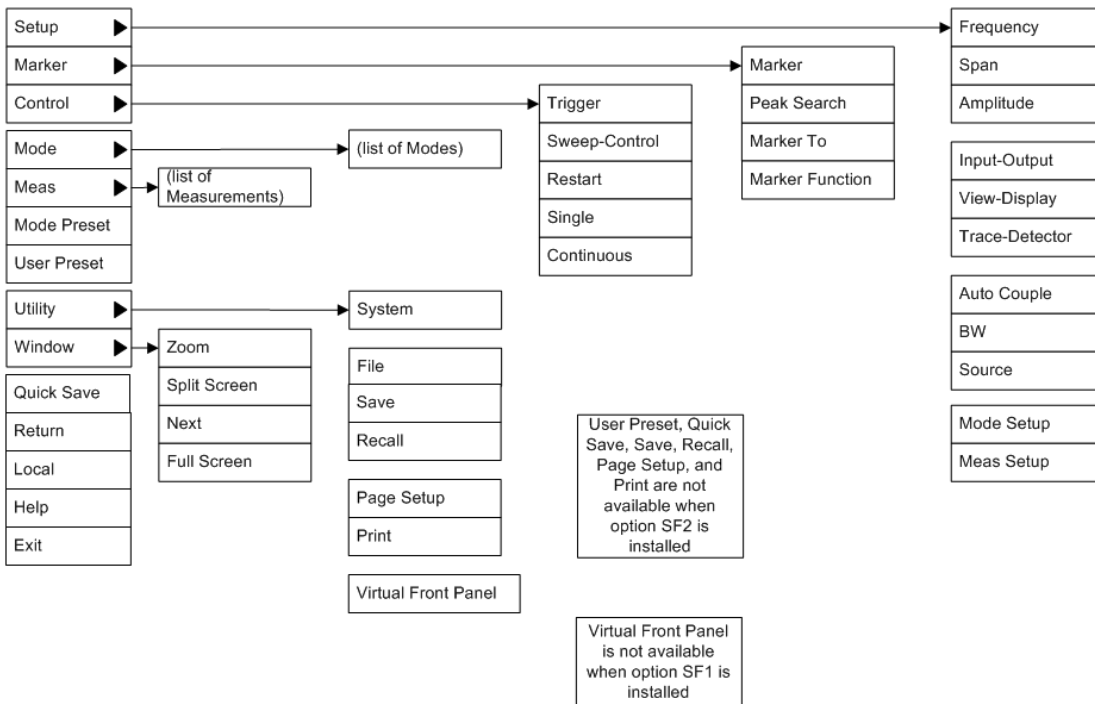

## PC Keyboard

If you have a PC keyboard plugged in (or via Remote Desktop), certain key codes on the PC keyboard map to front-panel keys on the GPSA front panel. These key codes are shown below:

Front-panel key	Key code
Frequency	CTRL+SHIFT+F
Span	CTRL+SHIFT+S
Amplitude	CTRL+SHIFT+A
Input/Output	CTRL+SHIFT+O
View/Display	CTRL+SHIFT+V
Trace/Detector	CTRL+ALT+T
Auto Couple	CTRL+SHIFT+C
Bandwidth	CTRL+ALT+B
Source	CTRL+ALT-U
Marker	CTRL+ALT+K
Peak Search	CTRL+ALT+P
Marker To	CTRL+ALT+N
Marker Function	CTRL+ALT+F
System	CTRL+SHIFT+Y
Quick Save	CTRL+Q
Save	CTRL+S
Recall	CTRL+R
Mode Preset	CTRL+M
User Preset	CTRL+U
Print	CTRL+P
File	CTRL+SHIFT+L
Mode	CTRL+SHIFT+M
Measure	CTRL+ALT+M
Mode Setup	CTRL+SHIFT+E
Meas Setup	CTRL+ALT+E
Trigger	CTRL+SHIFT+T
Sweep/Control	CTRL+SHIFT+W
Restart	CTRL+ALT+R
Single	CTRL+ALT+S
Cont	CTRL+ALT+C
Zoom	CTRL+SHIFT+Z
Next Window	CTRL+SHIFT+N
Split Screen	CTRL+L

Front-panel key	Key code
Full Screen	CTRL+SHIFT+B
Return	CTRL+SHIFT+R
Mute	Mute
Inc Audio	Volume Up
Dec Audio	Volume Down
Help	F1
Control	CTRL
Alt	ALT
Enter	Return
Cancel	Esc
Del	Delete
Backspace	Backspace
Select	Space
Up Arrow	Up
Down Arrow	Down
Left Arrow	Left
Right Arrow	Right
Menu key 1	CTRL+SHIFT+F1
Menu key 2	CTRL+SHIFT+F2
Menu key 3	CTRL+SHIFT+F3
Menu key 4	CTRL+SHIFT+F4
Menu key 5	CTRL+SHIFT+F5
Menu key 6	CTRL+SHIFT+F6
Menu key 7	CTRL+SHIFT+F7
Backspace	BACKSPACE
Enter	ENTER
Tab	Tab
1	1
2	2
3	3
4	4
5	5
6	6
7	7
8	8
9	9
0	0

This is a pictorial view of the table:

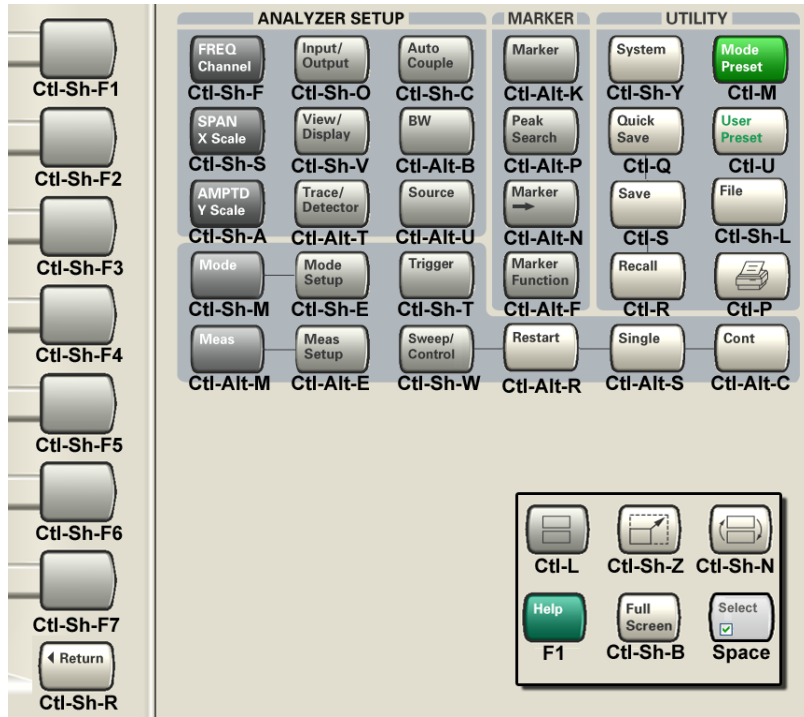

## Instrument Security & Memory Volatility

If you are using the instrument in a secure environment, you may need details of how to clear or sanitize its memory, in compliance with published security standards of the United States Department of Defense, or other similar authorities.

For X-Series analyzers, this information is contained in the document "Security Features and Document of Volatility". This document is not included in the Documentation CD, or the instrument's on-disk library, but it may be downloaded from Keysight's web site.

To obtain a copy of the document, click on or browse to the following URL:

<http://www.agilent.com/find/security>

To locate and download the document, select Model Number "N9020A", then click "Submit". Then, follow the on-screen instructions to download the file.





## 2 About the EMI Receiver Measurement Application

This section provides information on using the EMI Receiver Mode in your X-Series Signal Analyzer or your MXE EMI Receiver.

The MXE EMI Receiver allows you to make fully CISPR compliant measurements. The X-Series signal analyzers allow you to make the same measurements in a precompliance environment

The N6141A and W6141A EMC measurement applications enable you to perform conducted and radiated emissions tests to both commercial and MIL-STD requirements. It provides better sensitivity, accuracy and reduces test margins, across the X-Series signal analyzers, so you can make more precise measurements. The wide range of features enables you to use the scan table to set up frequency ranges, gains, bandwidths and dwell time. You can scan a frequency range and display the results in log or linear format, search for signals, measure the peak, quasi-peak and average values of the signals and place the results in a table. Use the Signal List feature to mark and delete unwanted signals, leaving only those of interest

This measurement application enables you to:

- Identify out-of-limit device emissions
  - See device emissions typically hidden in the noise floor
  - Differentiate between ambient signals and device emissions
  - View signals over time to identify intermittent responses
- Maximize signals and compare against regulatory requirements
  - Built-in commercial and MIL-STD compliant bandwidths, detectors and band presets
  - Continuously monitor signals with bar meters to detect maximum amplitude
  - Compare measured emissions to regulatory limits

You can access this application by way of the front panel or a remote interface.



### 3 Programming the Analyzer

This section provides introductory information about the programming documentation included with your product.

- ["What Programming Information is Available?" on page 68](#)
- ["STATus Subsystem " on page 98](#)
- ["IEEE 488.2 Common Commands" on page 140](#)

## What Programming Information is Available?

The X-Series Documentation can be accessed through the Additional Documentation page in the instrument Help system and is included on the Documentation DVD shipped with the instrument. It can also be found online at: [http://www.agilent.com/find/mxa\\_manuals](http://www.agilent.com/find/mxa_manuals).

The following resources are available to help you create programs for automating your X-Series measurements:

Resource	Description
X-Series Programmer's Guide	<p>Provides general SCPI programming information on the following topics:</p> <ul style="list-style-type: none"><li>• Programming the X-Series Applications</li><li>• Programming fundamentals</li><li>• Programming examples</li></ul> <p>Note that SCPI command descriptions for measurement applications are not in this book, but are in the User's and Programmer's Reference.</p>
User's and Programmer's Reference manuals	<p>Describes all front-panel keys and softkeys, including SCPI commands for a measurement application. Note that:</p> <ul style="list-style-type: none"><li>• Each measurement application has its own User's and Programmer's Reference.</li><li>• The content in this manual is duplicated in the instrument's Help (the Help that you see for a key is identical to what you see in this manual).</li></ul>
Embedded Help in your instrument	<p>Describes all front-panel keys and softkeys, including SCPI commands, for a measurement application. Note that the content that you see in Help when you press a key is identical to what you see in the User's and Programmer's Reference.</p>
X-Series Getting Started Guide	<p>Provides valuable sections related to programming including:</p> <ul style="list-style-type: none"><li>• Licensing New Measurement Application Software - After Initial Purchase</li><li>• Configuring instrument LAN Hostname, IP Address, and Gateway Address</li><li>• Using the Windows Remote Desktop to connect to the instrument remotely</li><li>• Using the Embedded Web Server Telnet connection to communicate SCPI</li></ul> <p>This printed document is shipped with the instrument.</p>
Keysight Application Notes	<p>Printable PDF versions of pertinent application notes.</p>
Keysight VISA User's Guide	<p>Describes the Keysight Virtual Instrument Software Architecture (VISA) library and shows how to use it to develop I/O applications and instrument drivers on Windows PCs.</p>

## List of SCPI Commands

```

*CAL?
*CLS
*ESE <integer>
*ESE?
*ESR?
*IDN?
*OPC
*OPC?
*OPT?
*RCL <register#>
*RST
*SAV <register#>
*SRE <integer>
*SRE?
*STB?
*TRG
*TST?
*WAI
ABORT
CALCulate:APD:LLINE:ALL:DELeTe
CALCulate:APD:LLINE[1]:COMMeNt "string"
CALCulate:APD:LLINE[1]:COMMeNt ?
CALCulate:APD:LLINE[1]:DELeTe
CALCulate:APD:LLINE[1]:DESCription "string"
CALCulate:APD:LLINE[1]:DESCription?
CALCulate:APD:LLINE[1]:DISPlay ON | OFF | 1 | 0
CALCulate:APD:LLINE[1]:DISPlay?
CALCulate:APD:LLINE[1]:DLEVel:CONTRol[:DATA] <x>, <x>, ...
CALCulate:APD:LLINE[1]:DLEVel:CONTRol[:DATA]?
CALCulate:APD:LLINE[1]:DLEVel:CONTRol:POINts?
CALCulate:APD:LLINE[1]:DLEVel[:DATA] <ampl>, <ampl>, ...
CALCulate:APD:LLINE[1]:DLEVel[:DATA]?
CALCulate:APD:LLINE[1]:DLEVel:POINts?
CALCulate:APD:LLINE[1]:FAIL?
CALCulate:APD:LLINE[1]:METHod DLEVel | PROBAbility
CALCulate:APD:LLINE[1]:METHod?
CALCulate:APD:LLINE[1]:METHod:DLEVel:PROBAbility N1 | N2 | N3 | N4 | N5 |
N6 | N7
CALCulate:APD:LLINE[1]:METHod:DLEVel:PROBAbility?
CALCulate:APD:LLINE[1]:METHod:PROBAbility:DLEVel <ampl>
CALCulate:APD:LLINE[1]:METHod:PROBAbility:DLEVel?
CALCulate:APD:LLINE[1]:PROBAbility:CONTRol[:DATA] <x>, <x>, ...
CALCulate:APD:LLINE[1]:PROBAbility:CONTRol[:DATA]?
CALCulate:APD:LLINE[1]:PROBAbility:CONTRol:POINts?
CALCulate:APD:LLINE[1]:PROBAbility[:DATA] <double> | <double> | ...
CALCulate:APD:LLINE[1]:PROBAbility[:DATA]?
CALCulate:APD:LLINE[1]:PROBAbility:POINts?
CALCulate:APD:LLINE:TEST ON | OFF | 1 | 0
CALCulate:APD:LLINE:TEST?
CALCulate:APD:LLINE[1]:TRACe MEAS | MEAS2

```

### 3 Programming the Analyzer

#### List of SCPI Commands

```
CALCulate:APD:LLINE[1]:TRACe?
CALCulate:APD:MARKer:AOFF
CALCulate:APD:MARKer:COUPle[:STATe] OFF | ON | 0 | 1
CALCulate:APD:MARKer:COUPle[:STATe]?
CALCulate:APD:MARKer[1]|2|...|12:MAXimum
CALCulate:APD:MARKer[1]|2|...|12:MODE POSITION | DELTA | OFF
CALCulate:APD:MARKer[1]|2|...|12:MODE?
CALCulate:APD:MARKer[1]|2|...|12:REFeRence <integer>
CALCulate:APD:MARKer[1]|2|...|12:REFeRence?
CALCulate:APD:MARKer[1]|2|...|12[:SET]:SLIST
CALCulate:APD:MARKer[1]|2|...|12:TRACe MEAS | MEAS2 | ELIMit
CALCulate:APD:MARKer[1]|2|...|12:TRACe?
CALCulate:APD:MARKer[1]|2|...|12:X <rel_ampl>
CALCulate:APD:MARKer[1]|2|...|12:X?
CALCulate:APD:MARKer[1]|2|...|12:Y?
CALCulate:APD:SLIST:APPend
CALCulate:APD:SLIST:REPLace <integer>
CALCulate:APD:TRACe[1]|2:FAIL?
CALCulate:CLIMits:FAIL?
CALCulate:DANalyzer:DLIST:COMMeNt <integer>, 'string'
CALCulate:DANalyzer:DLIST:COMMeNt? <integer>
CALCulate:DANalyzer:DLIST:DELeTe:ALL
CALCulate:DANalyzer:DLIST:SORT:AUTO ON | OFF | 1 | 0
CALCulate:DANalyzer:DLIST:SORT:AUTO?
CALCulate:DANalyzer:DLIST:SORT:DAMPlitude ?
CALCulate:DANalyzer:DLIST:SORT:DAMPlitude PEAK | QPEak
CALCulate:DANalyzer:DLIST:SORT:ORDeR ASCending | DESCending
CALCulate:DANalyzer:DLIST:SORT:ORDeR?
CALCulate:DANalyzer:DLIST:SORT:TYPE DURation | DAMPlitude | TDISTurbance |
TIME
CALCulate:DANalyzer:DLIST:SORT:TYPE?
CALCulate:DANalyzer:DLIST:ZOOM <integer>
CALCulate:DANalyzer:DLIST:ZOOM:OUT
CALCulate:DANalyzer:LIMit <amptd>
CALCulate:DANalyzer:LIMit?
CALCulate:DANalyzer:LIMit:AUTO ON | OFF | 1 | 0
CALCulate:DANalyzer:LIMit:AUTO?
CALCulate:DANalyzer:LIMit:CISPr:TERMinal MAINS | LOAD | MP1 | MP2 | MP3
CALCulate:DANalyzer:LIMit:CISPr:TERMinal?
CALCulate:DANalyzer:MARKer:AOFF
CALCulate:DANalyzer:MARKer:COUPle[:STATe] ON | OFF | 1 | 0
CALCulate:DANalyzer:MARKer:COUPle[:STATe]?
CALCulate:DANalyzer:MARKer[1]|2|...|12:FUNCTion:PREVious:ZOOM
CALCulate:DANalyzer:MARKer[1]|2|...|12:FUNCTion:ZOOM
CALCulate:DANalyzer:MARKer[1]|2|...|12:FUNCTion:ZOOM:CLEar
CALCulate:DANalyzer:MARKer[1]|2|...|12:FUNCTion:ZOOM:OUT
CALCulate:DANalyzer:MARKer[1]|2|...|12:MAXimum
CALCulate:DANalyzer:MARKer[1]|2|...|12:MAXimum:NEXT
CALCulate:DANalyzer:MARKer[1]|2|...|12:MINimum
CALCulate:DANalyzer:MARKer[1]|2|...|12:MODE POSITION | DELTA | OFF
CALCulate:DANalyzer:MARKer[1]|2|...|12:MODE?
CALCulate:DANalyzer:MARKer[1]|2|...|12:REFeRence <integer>
CALCulate:DANalyzer:MARKer[1]|2|...|12:REFeRence?
```

```

CALCulate:DANalyzer:MARKer[1]|2|...|12[:SET]:DELTA:SPAN
CALCulate:DANalyzer:MARKer[1]|2|...|12:TRACe 1 | 2
CALCulate:DANalyzer:MARKer[1]|2|...|12:TRACe?
CALCulate:DANalyzer:MARKer[1]|2|...|12:X <real>
CALCulate:DANalyzer:MARKer[1]|2|...|12:X?
CALCulate:DANalyzer:MARKer[1]|2|...|12:Y?
CALCulate:DANalyzer:TABLE:DISPlay OFF | ON | 0 | 1
CALCulate:DANalyzer:TABLE:DISPlay?
CALCulate:DATA<n>:COMPRESS? BLOCk | CFIT | MAXimum | MINimum | MEAN |
DMEan | RMS | RMSCubed | SAMPLe | SDEVIation | PPHase[, <soffset>[,
<length>[, <roffset>[, <rlimit>]]]]
CALCulate:DATA[n]?
CALCulate:DATA[1]|2|...|6:PEAKs? <threshold>, <excursion>[, AMPLitude |
FREQuency | TIME]
CALCulate:DATA[1]|2|...|6:PEAKs? <threshold>, <excursion>[, AMPLitude |
FREQuency | TIME[, ALL | GTDLIne | LTDLine]]
CALCulate[1]|2:DELTamarker[1]|2|...|4:MAXimum:LEFT
CALCulate[1]|2:DELTamarker[1]|2|...|4:MAXimum:NEXT
CALCulate[1]|2:DELTamarker[1]|2|...|4:MAXimum[:PEAK]
CALCulate[1]|2:DELTamarker[1]|2|...|4:MAXimum:RIGHT
CALCulate[1]|2:DELTamarker[1]|2|...|4:MINimum[:PEAK]
CALCulate[1]|2:DELTamarker[1]|2|...|4[:STATE] ON | OFF | 1 | 0
CALCulate[1]|2:DELTamarker[1]|2|...|4[:STATE] ON | OFF | 1 | 0
CALCulate[1]|2:DELTamarker[1]|2|...|4[:STATE] ON | OFF | 1 | 0
CALCulate[1]|2:DELTamarker[1]|2|...|4[:STATE]?
CALCulate[1]|2:DELTamarker[1]|2|...|4[:STATE]?
CALCulate[1]|2:DELTamarker[1]|2|...|4[:STATE]?
CALCulate[1]|2:DELTamarker[1]|2|...|4:X <value>
CALCulate[1]|2:DELTamarker[1]|2|...|4:X <value>
CALCulate[1]|2:DELTamarker[1]|2|...|4:X <value>
CALCulate[1]|2:DELTamarker[1]|2|...|4:X?
CALCulate[1]|2:DELTamarker[1]|2|...|4:X?
CALCulate[1]|2:DELTamarker[1]|2|...|4:X?
CALCulate[1]|2:DELTamarker[1]|2|...|4:Y?
CALCulate[1]|2:DELTamarker[1]|2|...|4:Y?
CALCulate[1]|2:DELTamarker[1]|2|...|4:Y?
CALCulate:EMI:SLIST:CLEAr ALL | CURRent
CALCulate:EMI:SLIST:DELeTe ALL | CURRent | MARKed | UNMarked
CALCulate:EMI:SLIST:MARK CURRent | DUPLicate | ALL
CALCulate:FSCan:LLINE:ALL:DELeTe
CALCulate:FSCan:LLINE[1]|2|...|6:AMPLitude:CMODE:RELative ON | OFF | 1 | 0
CALCulate:FSCan:LLINE[1]|2|...|6:AMPLitude:CMODE:RELative?
CALCulate:FSCan:LLINE[1]|2|...|6:AMPLitude:INTerpolate:TYPE LOGarithmic |
LINear
CALCulate:FSCan:LLINE[1]|2|...|6:AMPLitude:INTerpolate:TYPE?
CALCulate:FSCan:LLINE[1]|2|...|6:BUILd TRACE1 | TRACE2 | TRACE3
CALCulate:FSCan:LLINE[1]|2|...|6:COMMENT ?
CALCulate:FSCan:LLINE[1]|2|...|6:COMMENT "string"
CALCulate:FSCan:LLINE[1]|2|...|6:CONTrol[:DATA] <x>, <x>, ...
CALCulate:FSCan:LLINE[1]|2|...|6:CONTrol[:DATA]?
CALCulate:FSCan:LLINE[1]|2|...|6:CONTrol:INTerpolate:TYPE LOGarithmic |
LINear

```

### 3 Programming the Analyzer

#### List of SCPI Commands

```
CALCulate:FSCan:LLINE[1]|2|...|6:CONTROL:INTERpolate:TYPE?
CALCulate:FSCan:LLINE[1]|2|...|6:CONTROL:POINTS?
CALCulate:FSCan:LLINE[1]|2|...|6:COPY LLINE1 | LLINE2 | LLINE3 | LLINE4 |
LLINE5 | LLINE6
CALCulate:FSCan:LLINE[1]|2|...|6:DELETE
CALCulate:FSCan:LLINE[1]|2|...|6:DESCRIPTION "string"
CALCulate:FSCan:LLINE[1]|2|...|6:DESCRIPTION?
CALCulate:FSCan:LLINE[1]|2|...|6:DISPLAY ON | OFF | 1 | 0
CALCulate:FSCan:LLINE[1]|2|...|6:DISPLAY?
CALCulate:FSCan:LLINE[1]|2|...|6:FAIL?
CALCulate:FSCan:LLINE[1]|2|...|6:FREQUENCY:CMODE:RELATIVE ON | OFF | 1 | 0
CALCulate:FSCan:LLINE[1]|2|...|6:FREQUENCY:CMODE:RELATIVE?
CALCulate:FSCan:LLINE[1]|2|...|6:MARGIN <rel_ampl>
CALCulate:FSCan:LLINE[1]|2|...|6:MARGIN?
CALCulate:FSCan:LLINE[1]|2|...|6:MARGIN:STATE ON | OFF | 1 | 0
CALCulate:FSCan:LLINE[1]|2|...|6:MARGIN:STATE?
CALCulate:FSCan:LLINE[1]|2|...|6:OFFSET:UPDATE
CALCulate:FSCan:LLINE[1]|2|...|6:OFFSET:X <freq>
CALCulate:FSCan:LLINE[1]|2|...|6:OFFSET:X?
CALCulate:FSCan:LLINE[1]|2|...|6:OFFSET:Y <rel_ampl>
CALCulate:FSCan:LLINE[1]|2|...|6:OFFSET:Y?
CALCulate:FSCan:LLINE:TEST ON | OFF | 1 | 0
CALCulate:FSCan:LLINE:TEST?
CALCulate:FSCan:LLINE[1]|2|...|6:TRACE 1 | 2 | 3
CALCulate:FSCan:LLINE[1]|2|...|6:TRACE?
CALCulate:FSCan:LLINE[1]|2|...|6:UPPER[:DATA] <ampl>, <ampl>, ...
CALCulate:FSCan:LLINE[1]|2|...|6:UPPER[:DATA]?
CALCulate:FSCan:LLINE[1]|2|...|6:UPPER:POINTS?
CALCulate:FSCan:MAMarker:PCENTER ON | OFF | 1 | 0
CALCulate:FSCan:MAMarker:PCENTER?
CALCulate:FSCan:MAMarker[:SET]:SLIST
CALCulate:FSCan:MARKer:AOFF
CALCulate:FSCan:MARKer:COUPLE:METER ON | OFF | 1 | 0
CALCulate:FSCan:MARKer:COUPLE:METER?
CALCulate:FSCan:MARKer:COUPLE[:STATE] OFF | ON | 0 | 1
CALCulate:FSCan:MARKer:COUPLE[:STATE]?
CALCulate:FSCan:MARKer[1]|2|...|12:FUNCTION:MAMarker?
CALCulate:FSCan:MARKer[1]|2|...|12:FUNCTION:ZOOM
CALCulate:FSCan:MARKer:FUNCTION:ZOOM:OUT
CALCulate:FSCan:MARKer[1]|2|...|12:MAXimum
CALCulate:FSCan:MARKer[1]|2|...|12:MAXimum:LEFT
CALCulate:FSCan:MARKer[1]|2|...|12:MAXimum:NEXT
CALCulate:FSCan:MARKer[1]|2|...|12:MAXimum:RIGHT
CALCulate:FSCan:MARKer[1]|2|...|12:MINimum
CALCulate:FSCan:MARKer[1]|2|...|12:MODE POSITION | DELTA | OFF
CALCulate:FSCan:MARKer[1]|2|...|12:MODE?
CALCulate:FSCan:MARKer:PEAK:EXCURSION <rel_ampl>
CALCulate:FSCan:MARKer:PEAK:EXCURSION?
CALCulate:FSCan:MARKer:PEAK:EXCURSION:STATE ON | OFF | 1 | 0
CALCulate:FSCan:MARKer:PEAK:EXCURSION:STATE?
CALCulate:FSCan:MARKer:PEAK:SEARCH:MODE MAXimum | PARAMeter
CALCulate:FSCan:MARKer:PEAK:SEARCH:MODE?
CALCulate:FSCan:MARKer:PEAK:THRESHOLD <ampl>
```



```

CALCulate:FSCan:MARKer:PEAK:THReshold?
CALCulate:FSCan:MARKer:PEAK:THReshold:STATE ON | OFF | 1 | 0
CALCulate:FSCan:MARKer:PEAK:THReshold:STATE?
CALCulate:FSCan:MARKer[1]|2|...|12:REFErence <integer>
CALCulate:FSCan:MARKer[1]|2|...|12:REFErence?
CALCulate:FSCan:MARKer[1]|2|...|12[:SET]:METer
CALCulate:FSCan:MARKer[1]|2|...|12[:SET]:SLIST
CALCulate:FSCan:MARKer[1]|2|...|12:TO:METer
CALCulate:FSCan:MARKer[1]|2|...|12:TRACe 1 | 2 | 3
CALCulate:FSCan:MARKer[1]|2|...|12:TRACe?
CALCulate:FSCan:MARKer[1]|2|...|12:X <real>
CALCulate:FSCan:MARKer[1]|2|...|12:X?
CALCulate:FSCan:MARKer[1]|2|...|12:Y?
CALCulate:FSCan:SCAN:DISPlay G1 | G2 | OFF
CALCulate:FSCan:SCAN:DISPlay?
CALCulate:FSCan:SLIST:APPend:METer
CALCulate:FSCan:SLIST:DELeTe:ALL
CALCulate:FSCan:SLIST:DELeTe:MARKed
CALCulate:FSCan:SLIST:DELeTe:SIGNAL <integer>
CALCulate:FSCan:SLIST:DELeTe:UNMarked
CALCulate:FSCan:SLIST:LDELta:UPDate
CALCulate:FSCan:SLIST:MARK:ALL
CALCulate:FSCan:SLIST:MARK:CLEar:ALL
CALCulate:FSCan:SLIST:MARK:CLEar:SIGNAL <integer>
CALCulate:FSCan:SLIST:MARK:DUPLicates[:ALL]
CALCulate:FSCan:SLIST:MARK:DUPLicates:LOWer
CALCulate:FSCan:SLIST:MARK:DUPLicates:UPPer
CALCulate:FSCan:SLIST:MARK:SIGNAL <integer>
CALCulate:FSCan:SLIST:REPLace:METer <integer>
CALCulate:FSCan:SLIST:SET:METer <integer>
CALCulate:FSCan:SLIST:SNAP:METers
CALCulate:FSCan:SLIST:SORT:AUTO ON | OFF | 1 | 0
CALCulate:FSCan:SLIST:SORT:AUTO?
CALCulate:FSCan:SLIST:SORT:DAMplitude DET1 | DET2 | DET3
CALCulate:FSCan:SLIST:SORT:DAMplitude ?
CALCulate:FSCan:SLIST:SORT:DLDelta DET1 | DET2 | DET3
CALCulate:FSCan:SLIST:SORT:DLDelta?
CALCulate:FSCan:SLIST:SORT:ORder ASCending | DESCending
CALCulate:FSCan:SLIST:SORT:ORder?
CALCulate:FSCan:SLIST:SORT:TYPE FREQuency | DAMplitude | DLDelta | TIME
CALCulate:FSCan:SLIST:SORT:TYPE?
CALCulate:FSCan:SLIST:ZOOM <integer>
CALCulate:FSCan:SLIST:ZOOM:OUT
CALCulate:FSCan:TRACe[1]|2|3:FAIL?
CALCulate[1]|2:LIMit[1]|2|...|6:COMMEnt
CALCulate[1]|2:LIMit[1]|2|...|6:COMMEnt
CALCulate[1]|2:LIMit[1]|2|...|6:CONTRol[:DATA]
CALCulate[1]|2:LIMit[1]|2|...|6:CONTRol[:DATA]
CALCulate[1]|2:LIMit[1]|2|...|6:COpy
CALCulate[1]|2:LIMit[1]|2|...|6:COpy
CALCulate[1]|2:LIMit[1]|2|...|6:DELeTe
CALCulate[1]|2:LIMit[1]|2|...|6:DELeTe
CALCulate[1]|2:LIMit[1]|2|...|6:FAIL?

```

3 Programming the Analyzer  
List of SCPI Commands

```

CALCulate[1]|2:LIMit[1]|2|...|6:FAIL?
CALCulate[1]|2:LIMit[1]|2|...|6:NAME
CALCulate[1]|2:LIMit[1]|2|...|6:NAME
CALCulate[1]|2:LIMit[1]|2|...|6:STATE
CALCulate[1]|2:LIMit[1]|2|...|6:STATE
CALCulate:LIMit[1]|2|...|6:UPPer[:DATA]
CALCulate:LIMit[1]|2|...|6:UPPer[:DATA]
CALCulate:LLINE:ALL:DELeTe
CALCulate:LLINE[1]|2|...|6:AMPLitude:CMODE:RELative ON | OFF | 1 | 0
CALCulate:LLINE[1]|2|...|6:AMPLitude:CMODE:RELative?
CALCulate:LLINE[1]|2|...|6:AMPLitude:INTerpolate:TYPE LOGarithmic | LINear
CALCulate:LLINE[1]|2|...|6:AMPLitude:INTerpolate:TYPE?
CALCulate:LLINE[1]|2|...|6:BUILd TRACE1 | TRACE2 | TRACE3
CALCulate:LLINE[1]|2|...|6:COMMENT ?
CALCulate:LLINE[1]|2|...|6:COMMENT "string"
CALCulate:LLINE[1]|2|...|6:CONTrol[:DATA] <x>, <x>, ...
CALCulate:LLINE[1]|2|...|6:CONTrol[:DATA]?
CALCulate:LLINE[1]|2|...|6:CONTrol:INTerpolate:TYPE LOGarithmic | LINear
CALCulate:LLINE[1]|2|...|6:CONTrol:INTerpolate:TYPE?
CALCulate:LLINE[1]|2|...|6:CONTrol:POINTs?
CALCulate:LLINE[1]|2|...|6:COpy LLINE1 | LLINE2 | LLINE3 | LLINE4 | LLINE5
| LLINE6
CALCulate:LLINE[1]|2|...|6:DELeTe
CALCulate:LLINE[1]|2|...|6:DESCription "string"
CALCulate:LLINE[1]|2|...|6:DESCription?
CALCulate:LLINE[1]|2|...|6:DISPlay ON | OFF | 1 | 0
CALCulate:LLINE[1]|2|...|6:DISPlay?
CALCulate:LLINE[1]|2|...|6:FREQuency:CMODE:RELative ON | OFF | 1 | 0
CALCulate:LLINE[1]|2|...|6:FREQuency:CMODE:RELative?
CALCulate:LLINE[1]|2|...|6:MARGin <rel_ampl>
CALCulate:LLINE[1]|2|...|6:MARGin?
CALCulate:LLINE[1]|2|...|6:MARGin:STATE ON | OFF | 1 | 0
CALCulate:LLINE[1]|2|...|6:MARGin:STATE?
CALCulate:LLINE[1]|2|...|6:OFFSet:UPDate
CALCulate:LLINE[1]|2|...|6:OFFSet:X <freq>
CALCulate:LLINE[1]|2|...|6:OFFSet:X?
CALCulate:LLINE[1]|2|...|6:OFFSet:Y <rel_ampl>
CALCulate:LLINE[1]|2|...|6:OFFSet:Y?
CALCulate:LLINE:TEST ON | OFF | 1 | 0
CALCulate:LLINE:TEST?
CALCulate:LLINE[1]|2|...|6:TRACe 1 | 2 | 3
CALCulate:LLINE[1]|2|...|6:TRACe?
CALCulate:LLINE[1]|2|...|6:UPPer[:DATA] <ampl>, <ampl>, ...
CALCulate:LLINE[1]|2|...|6:UPPer[:DATA]?
CALCulate:LLINE[1]|2|...|6:UPPer:POINTs?
CALCulate[1]|2:MARKer:COUPled[:STATE] ON | OFF | 1 | 0
CALCulate[1]|2:MARKer:COUPled[:STATE]?
CALCulate[1]|2:MARKer[1]|2|...|4:MAXimum:LEFT
CALCulate[1]|2:MARKer[1]|2|...|4:MAXimum:NEXT
CALCulate[1]|2:MARKer[1]|2|...|4:MAXimum[:PEAK]
CALCulate[1]|2:MARKer[1]|2|...|4:MAXimum:RIGHT
CALCulate[1]|2:MARKer[1]|2|...|4[:STATE] ON | OFF | 1 | 0
CALCulate[1]|2:MARKer[1]|2|...|4[:STATE] ON | OFF | 1 | 0

```

```

CALCulate[1]|2:MARKer[1]|2|...|4[:STATE] ON | OFF | 1 | 0
CALCulate[1]|2:MARKer[1]|2|...|4[:STATE]?
CALCulate[1]|2:MARKer[1]|2|...|4[:STATE]?
CALCulate[1]|2:MARKer[1]|2|...|4[:STATE]?
CALCulate[1]|2:MARKer[1]|2|...|4:X <value>
CALCulate[1]|2:MARKer[1]|2|...|4:X <value>
CALCulate[1]|2:MARKer[1]|2|...|4:X <value>
CALCulate[1]|2:MARKer[1]|2|...|4:X?
CALCulate[1]|2:MARKer[1]|2|...|4:X?
CALCulate[1]|2:MARKer[1]|2|...|4:X?
CALCulate[1]|2:MARKer[1]|2|...|4:X?
CALCulate[1]|2:MARKer[1]|2|...|4:Y?
CALCulate[1]|2:MARKer[1]|2|...|4:Y?
CALCulate[1]|2:MARKer[1]|2|...|4:Y?
CALCulate:METER:LIMit:ALL:FAIL?
CALCulate:METER[1]|2|3:LIMit[:DATA] <ampl>
CALCulate:METER[1]|2|3:LIMit[:DATA]?
CALCulate:METER[1]|2|3:LIMit:FAIL?
CALCulate:METER[1]|2|3:LIMit:STATE ON | OFF | 1 | 0
CALCulate:METER[1]|2|3:LIMit:STATE?
CALCulate:METER:POWER[:CURRENT]?
CALCulate:METER:POWER:PEAK?
CALCulate:MONitor:LLINE[1]|2|...|6:FAIL?
CALCulate:MONitor:MARKer:AOFF
CALCulate:MONitor:MARKer:COUple[:STATE] ON | OFF | 1 | 0
CALCulate:MONitor:MARKer:COUple[:STATE]?
CALCulate:MONitor:MARKer[1]|2|...|12:MAXimum
CALCulate:MONitor:MARKer[1]|2|...|12:MAXimum:LEFT
CALCulate:MONitor:MARKer[1]|2|...|12:MAXimum:NEXT
CALCulate:MONitor:MARKer[1]|2|...|12:MAXimum:RIGHT
CALCulate:MONitor:MARKer[1]|2|...|12:MINimum
CALCulate:MONitor:MARKer[1]|2|...|12:MODE POSition | DELTA | OFF
CALCulate:MONitor:MARKer[1]|2|...|12:MODE?
CALCulate:MONitor:MARKer:PEAK:EXCursion <rel_ampl>
CALCulate:MONitor:MARKer:PEAK:EXCursion?
CALCulate:MONitor:MARKer:PEAK:EXCursion:STATE ON | OFF | 1 | 0
CALCulate:MONitor:MARKer:PEAK:EXCursion:STATE?
CALCulate:MONitor:MARKer:PEAK:SEARCH:MODE MAXimum | PARAMeter
CALCulate:MONitor:MARKer:PEAK:SEARCH:MODE?
CALCulate:MONitor:MARKer:PEAK:THReshold <real>
CALCulate:MONitor:MARKer:PEAK:THReshold?
CALCulate:MONitor:MARKer:PEAK:THReshold:STATE ON | OFF | 1 | 0
CALCulate:MONitor:MARKer:PEAK:THReshold:STATE?
CALCulate:MONitor:MARKer[1]|2|...|12:REference <integer>
CALCulate:MONitor:MARKer[1]|2|...|12:REference?
CALCulate:MONitor:MARKer[1]|2|...|12[:SET]:CENTER
CALCulate:MONitor:MARKer[1]|2|...|12:TRACe 1 | 2 | 3 | 4 | 5 | 6
CALCulate:MONitor:MARKer[1]|2|...|12:TRACe?
CALCulate:MONitor:MARKer[1]|2|...|12:X <real>
CALCulate:MONitor:MARKer[1]|2|...|12:X?
CALCulate:MONitor:MARKer[1]|2|...|12:Y?
CALCulate:MONitor:SLIST:APPend:METER
CALCulate:MONitor:SLIST:REPLace:METER <integer>
CALCulate:MONitor:TRACe[1]|2|3:FAIL?

```

### 3 Programming the Analyzer

#### List of SCPI Commands

```
CALCulate[1]|2:PEAKsearch|PSEarch:ADD <NumericValue>
CALCulate[1]|2:PEAKsearch|PSEarch:CLEAR[:IMMEDIATE]
CALCulate[1]|2:PEAKsearch|PSEarch[:IMMEDIATE]
CALCulate[1]|2:PEAKsearch|PSEarch:METHod SUBRange | PEAK
CALCulate[1]|2:PEAKsearch|PSEarch:METHod
CALCulate[1]|2:PEAKsearch|PSEarch:SUBRanges <integer>
CALCulate[1]|2:PEAKsearch|PSEarch:SUBRanges?
CALCulate:SCHart:LIMit:FAIL?
CALCulate:SCHart:MARKer:AOff
CALCulate:SCHart:MARKer:COUple[:STATE] ON | OFF | 1 | 0
CALCulate:SCHart:MARKer:COUple[:STATE]?
CALCulate:SCHart:MARKer[1]|2|...12:FUNCTion:PREVious:ZOOM
CALCulate:SCHart:MARKer[1]|2|...12:FUNCTion:ZOOM
CALCulate:SCHart:MARKer[1]|2|...12:FUNCTion:ZOOM:CLEAR
CALCulate:SCHart:MARKer[1]|2|...12:FUNCTion:ZOOM:OUT
CALCulate:SCHart:MARKer[1]|2|...12:MAXimum
CALCulate:SCHart:MARKer[1]|2|...12:MAXimum:NEXT
CALCulate:SCHart:MARKer[1]|2|...12:MINimum
CALCulate:SCHart:MARKer[1]|2|...12:MODE POSition | DELTA | OFF
CALCulate:SCHart:MARKer[1]|2|...12:MODE?
CALCulate:SCHart:MARKer[1]|2|...12:REFerence <integer>
CALCulate:SCHart:MARKer[1]|2|...12:REFerence?
CALCulate:SCHart:MARKer[1]|2|...12[:SET]:DELTA:SPAN
CALCulate:SCHart:MARKer[1]|2|...12:TRACe 1 | 2 | 3
CALCulate:SCHart:MARKer[1]|2|...12:TRACe?
CALCulate:SCHart:MARKer[1]|2|...12:X <real>
CALCulate:SCHart:MARKer[1]|2|...12:X?
CALCulate:SCHart:MARKer[1]|2|...12:Y?
CALCulate:SLISt:DELeTe:ALL
CALCulate:SLISt:DELeTe:MARKed
CALCulate:SLISt:DELeTe:SIGNAL <integer>
CALCulate:SLISt:DELeTe:UNMarked
CALCulate:SLISt:MARK:ALL
CALCulate:SLISt:MARK:CLEAR:ALL
CALCulate:SLISt:MARK:CLEAR:SIGNAL <integer>
CALCulate:SLISt:MARK:DUPLicates[:ALL]
CALCulate:SLISt:MARK:DUPLicates:LOWer
CALCulate:SLISt:MARK:DUPLicates:UPPer
CALCulate:SLISt:MARK:SIGNAL <integer>
CALCulate:SLISt:SET:METER <integer>
CALCulate:SLISt:SORT:AUTO ON | OFF | 1 | 0
CALCulate:SLISt:SORT:AUTO?
CALCulate:SLISt:SORT:DAMplitude ?
CALCulate:SLISt:SORT:DAMplitude DET1 | DET2 | DET3
CALCulate:SLISt:SORT:DLDelta DET1 | DET2 | DET3
CALCulate:SLISt:SORT:DLDelta?
CALCulate:SLISt:SORT:ORder ASCending | DESCending
CALCulate:SLISt:SORT:ORder?
CALCulate:SLISt:SORT:TYPE FREquency | DAMplitude | DLDelta | TIME
CALCulate:SLISt:SORT:TYPE?
CALCulate[1]|2:UNIT:POWER
CALibration[:ALL]
CALibration[:ALL]?
```

```
CALibration:AUTO ON | PARTial | OFF
CALibration:AUTO ALERT
CALibration:AUTO?
CALibration:AUTO:ALERT TEMperature | DAY | WEEK | NONE
CALibration:AUTO:ALERT?
CALibration:AUTO:MODE ALL | NRF
CALibration:AUTO:MODE?
CALibration:AUTO:TIME:OFF?
CALibration:DATA:BACKUp <filename>
CALibration:DATA:DEFault
CALibration:DATA:REStore <filename>
CALibration:EXPIred?
CALibration:FREQuency:REFerence:COARse
CALibration:FREQuency:REFerence:COARse <integer>
CALibration:FREQuency:REFerence:COARse?
CALibration:FREQuency:REFerence:FINE <integer>
CALibration:FREQuency:REFerence:FINE?
CALibration:FREQuency:REFerence:MODE CALibrated | USER
CALibration:FREQuency:REFerence:MODE?
CALibration:IQ:FLATness:I
CALibration:IQ:FLATness:IBAR
CALibration:IQ:FLATness:I | IBAR | Q | QBAR:TIME?
CALibration:IQ:FLATness:Q
CALibration:IQ:FLATness:QBAR
CALibration:IQ:ISOLation
CALibration:IQ:ISOLation:TIME?
CALibration:IQ:PROBE:I
CALibration:IQ:PROBE:IBar
CALibration:IQ:PROBE:I | IBAR | Q | QBAR:TIME?
CALibration:IQ:PROBE:I | Q:CLEar
CALibration:IQ:PROBE:Q
CALibration:IQ:PROBE:QBar
CALibration:NFLoor
CALibration:NFLoor?
CALibration:NRF
CALibration:NRF?
CALibration:NRFPreselector
CALibration:NRFPreselector?
CALibration:REFerence:CLOCK?
CALibration:REFerence:CLOCK:END?
CALibration:REFerence:CLOCK:INITialize?
CALibration:RF
CALibration:RF?
CALibration:RFPreselector:ALERT ON | OFF | 0 | 1
CALibration:RFPreselector:ALERT?
CALibration:RFPreselector:CONDUCTed
CALibration:RFPreselector:CONDUCTed?
CALibration:RFPreselector:FULL
CALibration:RFPreselector:FULL?
CALibration:RFPreselector:ONLY
CALibration:RFPreselector:ONLY?
CALibration:RFPreselector:RADiated
CALibration:RFPreselector:RADiated?
```

### 3 Programming the Analyzer

#### List of SCPI Commands

```
CALibration:RFPSelector:SCHeduler:RECurrence DAY | WEEK | OFF
CALibration:RFPSelector:SCHeduler:RECurrence?
CALibration:RFPSelector:SCHeduler:RECurrence:DAY SUN | MON | TUE | WED |
THU | FRI | SAT
CALibration:RFPSelector:SCHeduler:RECurrence:DAY?
CALibration:RFPSelector:SCHeduler:RECurrence:WEEK <integer>
CALibration:RFPSelector:SCHeduler:RECurrence:WEEK?
CALibration:RFPSelector:SCHeduler:STATE ON | OFF | 0 | 1
CALibration:RFPSelector:SCHeduler:STATE?
CALibration:RFPSelector:SCHeduler:TASK T1 | T2 | T3
CALibration:RFPSelector:SCHeduler:TASK?
CALibration:RFPSelector:SCHeduler:TIME:NEXT?
CALibration:RFPSelector:SCHeduler:TIME:START "date", "time"
CALibration:RFPSelector:SCHeduler:TIME:START?
CALibration:SOURce:STATE OFF | ON | 0 | 1
CALibration:SOURce:STATE?
CALibration:TDS
CALibration:TEMPerature:CURRent?
CALibration:TEMPerature:LALL?
CALibration:TEMPerature:LPReselector?
CALibration:TEMPerature:LRF?
CALibration:TEMPerature:NFLoor?
CALibration:TEMPerature:RFPSelector:LCONducted?
CALibration:TEMPerature:RFPSelector:LRADiated?
CALibration:TIME:ELAPsed:NFLoor?
CALibration:TIME:LALL?
CALibration:TIME:LPReselector?
CALibration:TIME:LRF?
CALibration:TIME:NFLoor?
CALibration:TIME:REFerence:CLOCK?
CALibration:TIME:RFPSelector:LCONducted?
CALibration:TIME:RFPSelector:LRADiated?
CALibration:YTF
CALibration:YTF?
CONF FSC
CONFigure?
CONFigure:APD
CONFigure:APD
CONFigure:APD:NDEFault
CONFigure:DANalyzer
CONFigure:DANalyzer:NDEFault
CONFigure:EMI:SLIST CURRENT | MARKED | ALL
CONFigure:FSCan
CONFigure:FSCan
CONFigure:FSCan:NDEFault
CONFigure:MONitor
CONFigure:SCHart
COUPLE ALL | NONE
DISPlay:<measurement>:ANNotation:TITLE:DATA <string>
DISPlay:<measurement>:ANNotation:TITLE:DATA?
DISPlay:ACTivefunc[:STATE] ON | OFF | 1 | 0
DISPlay:ACTivefunc[:STATE]?
DISPlay:ANNotation:MBAR[:STATE] OFF | ON | 0 | 1
```

```

DISPlay:ANNotation:MBAR[:STATE]?
DISPlay:ANNotation:SCREen[:STATE] OFF | ON | 0 | 1
DISPlay:ANNotation:SCREen[:STATE]?
DISPlay:ANNotation:TRACe[:STATE] ON | OFF | 1 | 0
DISPlay:ANNotation:TRACe[:STATE]?
DISPlay:APD:VIEW[1]:WINDow[1]:TRACe:X[:SCALE]:PDIVision <rel_ampl>
DISPlay:APD:VIEW[1]:WINDow[1]:TRACe:X[:SCALE]:PDIVision?
DISPlay:APD:VIEW[1]:WINDow[1]:TRACe:X[:SCALE]:RLEVel <real>
DISPlay:APD:VIEW[1]:WINDow[1]:TRACe:X[:SCALE]:RLEVel?
DISPlay:BACKlight ON | OFF
DISPlay:BACKlight?
DISPlay:BACKlight:INTensity <integer>
DISPlay:BACKlight:INTensity?
DISPlay:DANalyzer:VIEW:DISTurBance:ILINe ON | OFF | 1 | 0
DISPlay:DANalyzer:VIEW:DISTurBance:ILINe?
DISPlay:DANalyzer:VIEW[1]:WINDow[1]:TRACe:X[:SCALE]:FULL
DISPlay:DANalyzer:VIEW[1]:WINDow[1]:TRACe:X[:SCALE]:PDIVision <time>
DISPlay:DANalyzer:VIEW[1]:WINDow[1]:TRACe:X[:SCALE]:PDIVision?
DISPlay:DANalyzer:VIEW[1]:WINDow[1]:TRACe:X[:SCALE]:RLEVel <time>
DISPlay:DANalyzer:VIEW[1]:WINDow[1]:TRACe:X[:SCALE]:RLEVel?
DISPlay:DANalyzer:VIEW[1]:WINDow[1]:TRACe:Y[:SCALE]:PDIVision <rel_amptd>
DISPlay:DANalyzer:VIEW[1]:WINDow[1]:TRACe:Y[:SCALE]:PDIVision?
DISPlay:DANalyzer:VIEW[1]:WINDow[1]:TRACe:Y[:SCALE]:RLEVel <real>
DISPlay:DANalyzer:VIEW[1]:WINDow[1]:TRACe:Y[:SCALE]:RLEVel?
DISPlay:ENABLE OFF | ON | 0 | 1
DISPlay:ENABLE?
DISPlay:FSCan:VIEW:METER:FLINe ON | OFF | 1 | 0
DISPlay:FSCan:VIEW:METER:FLINe?
DISPlay:FSCan:VIEW:METER[:STATE] ON | OFF | 1 | 0
DISPlay:FSCan:VIEW:METER[:STATE]?
DISPlay:FSCan:VIEW[1]:WINDow[1]:TRACe:Y[:SCALE]:PDIVision <rel_ampl>
DISPlay:FSCan:VIEW[1]:WINDow[1]:TRACe:Y[:SCALE]:PDIVision?
DISPlay:FSCan:VIEW[1]:WINDow[1]:TRACe:Y[:SCALE]:RLEVel <real>
DISPlay:FSCan:VIEW[1]:WINDow[1]:TRACe:Y[:SCALE]:RLEVel?
DISPlay:FSCan:VIEW[1]:WINDow[1]:TRACe:Y[:SCALE]:RLEVel:OFFSet <rel_ampl>
DISPlay:FSCan:VIEW[1]:WINDow[1]:TRACe:Y[:SCALE]:RLEVel:OFFSet?
DISPlay:FSCan:WINDow:MAMarker:POSition ULEFT | LLEFT | URIGHT | LRIGHT
DISPlay:FSCan:WINDow:MAMarker:POSition?
DISPlay:FSCan:WINDow:MAMarker[:STATE] ON | OFF | 1 | 0
DISPlay:FSCan:WINDow:MAMarker[:STATE]?
DISPlay:FSCREEN[:STATE] OFF | ON | 0 | 1
DISPlay:FSCREEN[:STATE]?
DISPlay:MENU[:STATE] OFF | ON | 0 | 1
DISPlay:METER[1]|2|3[:STATE] ON | OFF | 0 | 1
DISPlay:METER[1]|2|3[:STATE]?
DISPlay:MONitor:RBWLINes[:STATE] ON | OFF | 1 | 0
DISPlay:MONitor:RBWLINes[:STATE]?
DISPlay:MONitor:VIEW:EXPand:METER[:STATE] ON | OFF | 1 | 0
DISPlay:MONitor:VIEW:EXPand:METER[:STATE]?
DISPlay:MONitor:VIEW:FSCan[:STATE] ON | OFF | 1 | 0
DISPlay:MONitor:VIEW:FSCan[:STATE]?
DISPlay:MONitor:VIEW[1]:WINDow[1]:TRACe:Y[:SCALE]:PDIVision <rel_ampl>
DISPlay:MONitor:VIEW[1]:WINDow[1]:TRACe:Y[:SCALE]:PDIVision?

```

### 3 Programming the Analyzer

#### List of SCPI Commands

```
DISPlay:MONitor:VIEW[1]:WINDow[1]:TRACe:Y[:SCALe]:RLEVel <real>
DISPlay:MONitor:VIEW[1]:WINDow[1]:TRACe:Y[:SCALe]:RLEVel?
DISPlay:MONitor:VIEW[1]:WINDow[1]:TRACe:Y[:SCALe]:RLEVel:OFFSet <rel_ampl>
DISPlay:MONitor:VIEW[1]:WINDow[1]:TRACe:Y[:SCALe]:RLEVel:OFFSet?
DISPlay:SCHart:VIEW:EXPand:METER[:STATE] ON | OFF | 1 | 0
DISPlay:SCHart:VIEW:EXPand:METER[:STATE]?
DISPlay:SCHart:VIEW[1]:WINDow[1]:TRACe:X[:SCALe]:FULL
DISPlay:SCHart:VIEW[1]:WINDow[1]:TRACe:X[:SCALe]:MAX:DURation <time>
DISPlay:SCHart:VIEW[1]:WINDow[1]:TRACe:X[:SCALe]:MAX:DURation?
DISPlay:SCHart:VIEW[1]:WINDow[1]:TRACe:X[:SCALe]:PDIVision <time>
DISPlay:SCHart:VIEW[1]:WINDow[1]:TRACe:X[:SCALe]:PDIVision?
DISPlay:SCHart:VIEW[1]:WINDow[1]:TRACe:X[:SCALe]:RLEVel <time>
DISPlay:SCHart:VIEW[1]:WINDow[1]:TRACe:X[:SCALe]:RLEVel?
DISPlay:SCHart:VIEW[1]:WINDow[1]:TRACe:Y[:SCALe]:PDIVision <rel_ampl>
DISPlay:SCHart:VIEW[1]:WINDow[1]:TRACe:Y[:SCALe]:PDIVision?
DISPlay:SCHart:VIEW[1]:WINDow[1]:TRACe:Y[:SCALe]:RLEVel <real>
DISPlay:SCHart:VIEW[1]:WINDow[1]:TRACe:Y[:SCALe]:RLEVel?
DISPlay:SCHart:VIEW[1]:WINDow[1]:TRACe:Y[:SCALe]:RLEVel:OFFSet <rel_ampl>
DISPlay:SCHart:VIEW[1]:WINDow[1]:TRACe:Y[:SCALe]:RLEVel:OFFSet?
DISPlay:VIEW[1]:WINDow[1]:TRACe:X:SPACing LINear |
LOGarithmic:DISPlay:VIEW[1]:WINDow[1]::TRACe:X:SPACing?
DISPlay:WINDow[1]:ANNOtation[:ALL] OFF | ON | 0 | 1
DISPlay:WINDow[1]:ANNOtation[:ALL]?
DISPlay:WINDow:FORMat:TILE
DISPlay:WINDow:FORMat:ZOOM
DISPlay:WINDow[:SElect] <number>
DISPlay:WINDow[:SElect]?
DISPlay:WINDow[1]:TRACe:GRATICule:GRID[:STATE] OFF | ON | 0 | 1
DISPlay:WINDow[1]:TRACe:GRATICule:GRID[:STATE]?
DISPlay[:WINDow]:TRACe[1]|2|3:MODE WRITE | VIEW | MAXHold | MINHold
DISPlay[:WINDow]:TRACe[1]|2|3:MODE?
DISPlay:WINDow[1]|2:TRACe[1]|2|3[:STATE]
DISPlay[:WINDow]:TRACe[1]|2|3[:STATE] ON | OFF | 1 | 0
DISPlay[:WINDow]:TRACe[1]|2|3[:STATE] ON | OFF | 1 | 0
DISPlay:WINDow[1]|2:TRACe[1]|2|3[:STATE]
DISPlay[:WINDow]:TRACe[1]|2|3[:STATE]?
DISPlay[:WINDow]:TRACe[1]|2|3[:STATE]?
DISPlay[:WINDow]:TRACe[1]|2|3:X:SPACing
DISPlay:WINDow[1]|2:TRACe[1]|2|3:X:SPACing
DISPlay:WINDow[1]:TRACe:Y:DLINe <ampl>
DISPlay:WINDow[1]:TRACe:Y:DLINe?
DISPlay:WINDow[1]:TRACe:Y:DLINe:STATE OFF | ON | 0 | 1
DISPlay:WINDow[1]:TRACe:Y:DLINe:STATE?
DISPlay:WINDow[1]|2:TRACe[1]|2|3:Y[:SCALe]:BOTTom
DISPlay:WINDow[1]|2:TRACe[1]|2|3:Y[:SCALe]:BOTTom
DISPlay[:WINDow]:TRACe[1]|2|3:Y[:SCALe]:BOTTom <real>
DISPlay[:WINDow]:TRACe[1]|2|3:Y[:SCALe]:BOTTom <real>
DISPlay[:WINDow]:TRACe[1]|2|3:Y[:SCALe]:BOTTom?
DISPlay[:WINDow]:TRACe[1]|2|3:Y[:SCALe]:BOTTom?
DISPlay:WINDow[1]|2:TRACe[1]|2|3:Y[:SCALe]:TOP
DISPlay[:WINDow]:TRACe[1]|2|3:Y[:SCALe]:TOP <real>
DISPlay[:WINDow]:TRACe[1]|2|3:Y[:SCALe]:TOP <real>
DISPlay:WINDow[1]|2:TRACe[1]|2|3:Y[:SCALe]:TOP
```



```

DISPlay[:WINDow]:TRACe[1]|2|3:Y[:SCALE]:TOP?
DISPlay[:WINDow]:TRACe[1]|2|3:Y[:SCALE]:TOP?
DISPlay:WINDow1|WINDow2:TRACe[1]|2|3:MODE
DISPlay:WINDow1|WINDow2:TRACe[1]|2|3:MODE?
FETCh:APD[n]?
FETCh:DANalyzer [n]?
FETCh:FSCan[n]?
FETCh:MONitor[n]?
FETCh:SCHart [n]?
FORMat:BORDER NORMAl | SWAPped
FORMat:BORDER?
FORMat[:TRACe][:DATA] ASCii | INTeger, 32 | REAL, 32 | REAL, 64
FORMat[:TRACe][:DATA]?
GLOBal:DEFault
GLOBal:FREQUency:CENTER[:STATE] 1 | 0 | ON | OFF
GLOBal:FREQUency:CENTER[:STATE]?
HCOPY:ABORT
HCOPY[:IMMediate]
HOLD
INIT:ABOR
INITiate:ABORt
INITiate:APD
INITiate:APD:SMEasure
INITiate:APD:STOP
INITiate[1]|2:CONMeas.
INITiate[1]:CONTinuous OFF
INITiate:CONTinuous OFF | ON | 0 | 1
INITiate2:CONTinuous ON | OFF | 1 | 0
INITiate[1]:CONTinuous ON
INITiate:CONTinuous?
INITiate2:CONTinuous?
INITiate:DANalyzer
INITiate:DANalyzer:SANalysis
INITiate[1]|2:EMITest
INITiate[1]|2:FMEasurement
INITiate:FSCan
INITiate:FSCan:CLEar:IMMediate
INITiate2:IMMediate
INITiate:IMMediate
INITiate[1]:IMMediate
INITiate:IMMediate
INITiate[:IMMediate]
INITiate:MONitor
INITiate:MONitor:CLEar:IMMediate
INITiate:PAUSE
INITiate:PAUSE
INITiate:PAUSE
INITiate2:REStart
INITiate:REStart
INITiate:REStart
INITiate[1]:REStart
INITiate:REStart
INITiate:RESume

```

### 3 Programming the Analyzer

#### List of SCPI Commands

```
INITiate:RESume
INITiate:RESume
INITiate:SCHart
INPut<1|2>:PRESelection[:STATE] ON | OFF
INPut<1|2>:PRESelection[:STATE]?
INPut<1|2>:TYPE INPUT1 | INPUT2
INPut<1|2>:TYPE?
INPut[1]|2:ATTenuation
INPut[1]|2:ATTenuation:AUTO
INPut[1]|2:ATTenuation:PROTEction
INPut:COUPling AC | DC
INPut:COUPling?
INPut:COUPling:I|Q DC | LFR1 | LFR2
INPut:COUPling:I|Q?
INPut[1]|2:GAIN:AUTO ON | OFF
INPut[1]|2:GAIN[:STATE] ON | OFF | 1 | 0
INPut[1]|2:GAIN[:STATE] ON | OFF | 1 | 0
INPut[1]|2:GAIN[:STATE]?
INPut[1]|2:GAIN[:STATE]?
INPut:IMPedance:REFerence <integer>
INPut:IMPedance:REFerence?
INPut[1]:IQ:BALanced[:STATE] OFF | ON | 0 | 1
INPut[1]:IQ:BALanced[:STATE]?
INPut:IQ[:I]:DIFFerential OFF | ON | 0 | 1
INPut:IQ[:I]:DIFFerential?
INPut[1]:IQ[:I]:IMPedance LOW | HIGH
INPut[1]:IQ[:I]:IMPedance?
INPut:IQ:MIRRored OFF | ON | 0 | 1
INPut:IQ:MIRRored?
INPut:IQ:Q:DIFFerential OFF | ON | 0 | 1
INPut:IQ:Q:DIFFerential?
INPut[1]:IQ:Q:IMPedance LOW | HIGH
INPut[1]:IQ:Q:IMPedance?
INPut[1]:IQ:TYPE IQ | I | Q
INPut[1]:IQ:TYPE?
INPut[1]|2:LISN:FILTer:HPAS[:STATE] ON | OFF | 1 | 0
INPut[1]|2:LISN:FILTer:HPAS[:STATE]?
INPut[1]|2:LISN:PEARth GROunded | FLOating
INPut[1]|2:LISN:PEARth?
INPut[1]|2:LISN:PHASe L1 | L2 | L3 | N
INPut[1]|2:LISN:PHASe?
INPut[1]|2:LISN[:TYPE] FOURphase | ESH2Z5 | ENV216 | OFF
INPut[1]|2:LISN[:TYPE]?
INPut:MIXer EXTernal | INTernal
INPut:MIXer?
INPut:OFFSet:I|Q <voltage>
INPut:OFFSet:I|Q?
INST:NSEL 102
INST:NSEL 105
INSTrument:CATalog?
INSTrument:COUPlE:DEFault
INSTrument:COUPlE:EMC:STANdard ALL | NONE
INSTrument:COUPlE:EMC:STANdard?
```

```

INSTRument:COUPle:FREQuency:CENTer ALL | NONE
INSTRument:COUPle:FREQuency:CENTer?
INSTRument:NSElect <integer>
INSTRument:NSElect?
INSTRument[:SElect] RECeiver
INSTRument[:SElect] SANalyzer
INSTRument[:SElect] 'SA' | 'PNOISE' | 'EDGE' | 'GSM' | 'BASIC'
INSTRument[:SElect] SA | RTSA | SEQAN | EMI | BASIC | WCDMA | EDGE GSM |
WIMAXOFDMA | VSA | PNOISE | NFIGure | ADEMOD | BTooth | TDSCDMA | CDMA2K |
CDMA1XEV | LTE | LTETDD | LTEAFDD | LTEATDD | MSR | DVB | DTMB | DCATV |
ISDBT | CMMB | WLAN | CWLAN | CWIMAXOFDM | WIMAXFIXED | IDEN | RLC |
SCPILC | VSA89601
INSTRument[:SElect] GSM
INSTRument[:SElect]?
INST:SEL EMI
INST:SEL LTETDD
INST:SEL SCPILC
INST:SEL LTE
LXI:IDENTify[:STATE] OFF | ON | 0 | 1
LXI:IDENTify[:STATE]?
MEASure:APD[n]?
MEASure:DANalyzer [n]?
MEASure:FSCan[n]?
MEASure:MONitor[n]?
MEASure|READ|FETCh:SCHart[1]|2?
MEASure:SCHart [n]?
MMEMory:CATalog? [<directory_name>]
MMEMory:CDIRectory [<directory_name>]
MMEMory:CDIRectory?
MMEMory:COPY <string>, <string>[, <string>, <string>]
MMEMory:COPY:DEVIce <source_string>, <dest_string>
MMEMory:DATA <file_name>, <data>
MMEMory:DATA? <file_name>
MMEMory:DELeTe <file_name>[, <directory_name>]
MMEMory:LOAD:ALIMit LLINE1, <filename>
MMEMory:LOAD:ALISt <filename>
MMEMory:LOAD:ATRace MEAS | MEAS2, <filename>
MMEMory:LOAD:CORRection 1 | 2 | 3 | 4 | 5 | 6 | 7 | 8, <filename>
MMEMory:LOAD:CORRection ANTenna | CABLe | OTHer | USER, <filename>
MMEMory:LOAD:CORRection:DDIRectory USER | PRELoaded
MMEMory:LOAD:DLISt <filename>
MMEMory:LOAD:DTRaces <filename>
MMEMory:LOAD:LIMit LLINE1 | LLINE2 | LLINE3 | LLINE4 | LLINE5 | LLINE6,
<filename>
MMEMory:LOAD:LIMit:DDIRectory USER | PRELoaded
MMEMory:LOAD:SCAN <filename>
MMEMory:LOAD:SLISt <filename>
MMEMory:LOAD:STATe <filename>
MMEMory:LOAD:STATe 1, <filename>
MMEMory:LOAD:TRACe:DATA TRACE1 | TRACE2 | TRACE3, <filename>
MMEMory:LOAD:TRACe:DATA TRACE1 | TRACE2 | TRACE3 | TRACE4 | TRACE5 |
TRACE6, <filename>

```

```
MMEMemory:MDIRectory <directory_name>
MMEMemory:MOVE <string>, <string>[, <string>, <string>]
MMEMemory:RDIRectory <directory_name>
MMEMemory:REGister:STATE:LABEL <regnumber>, "label"
MMEMemory:REGister:STATE:LABEL? <regnumber>
MMEMemory:RESults:CLient "string"
MMEMemory:RESults:CLient?
MMEMemory:RESults:COMMeNt "string"
MMEMemory:RESults:COMMeNt?
MMEMemory:RESults:CORRection:MODE OFF | DEScription | DATA
MMEMemory:RESults:CORRection:MODE?
MMEMemory:RESults:DLISt ON | OFF | 0 | 1
MMEMemory:RESults:DLISt?
MMEMemory:RESults:LIMits:MODE OFF | DEScription | DATA
MMEMemory:RESults:LIMits:MODE?
MMEMemory:RESults:MSEtUp ON | OFF | 0 | 1
MMEMemory:RESults:MSEtUp?
MMEMemory:RESults:OPERator "string"
MMEMemory:RESults:OPERator?
MMEMemory:RESults:OUTP?
MMEMemory:RESults:OUTPut HTML | PDF
MMEMemory:RESults:PDEScription "string"
MMEMemory:RESults:PDEScription?
MMEMemory:RESults:SCAN ON | OFF | 0 | 1
MMEMemory:RESults:SCAN?
MMEMemory:RESults:SCReen:THEMe OFF | FCOLor | TDColor
MMEMemory:RESults:SCReen:THEMe?
MMEMemory:RESults:SLISt ON | OFF | 0 | 1
MMEMemory:RESults:SLISt?
MMEMemory:RESults:TITLe "string"
MMEMemory:RESults:TITLe?
MMEMemory:RESults:TRACe ON | OFF | 0 | 1
MMEMemory:RESults:TRACe?
MMEMemory:RESults:TRACe:DATA ON | OFF | 0 | 1
MMEMemory:RESults:TRACe:DATA?
MMEMemory:RESults:TRACe:HEADer ON | OFF | 0 | 1
MMEMemory:RESults:TRACe:HEADer?
MMEMemory:RESults:TRACe:SETTing ON | OFF | 0 | 1
MMEMemory:RESults:TRACe:SETTing?
MMEMemory:STORe:ALIMit LLINE1, <filename>
MMEMemory:STORe:ALISt <filename>
MMEMemory:STORe:ATRACE MEAS | MEAS2 | ELIMit | ALL, <filename>
MMEMemory:STORe:CORRection ANTenna | CABLe | OTHER | USER, <filename>
MMEMemory:STORe:CORRection 1 | 2 | 3 | 4 | 5 | 6, <filename>
MMEMemory:STORe:DLISt <filename>
MMEMemory:STORe:DTRACES <filename>
MMEMemory:STORe:LIMit LLINE1 | LLINE2 | LLINE3 | LLINE4 | LLINE5 | LLINE6,
<filename>
MMEMemory:STORe:RESults <filename>
MMEMemory:STORe:RESults <filename>
MMEMemory:STORe:SCAN <filename>
MMEMemory:STORe:SCReen <filename>
MMEMemory:STORe:SCReen:THEMe TDColor | TDMonochrome | FCOLor | FMONochrome
```

```

MMEMory:STORe:SCReen:THEMe?
MMEMory:STORe:SLISt <filename>
MMEMory:STORe:STATe 1, <filename>
MMEMory:STORe:STATe <filename>
MMEMory:STORe:TRACe:DATA TRACE1 | TRACE2 | TRACE3 | ALL, <filename>
MMEMory:TRACe:CLient "string"
MMEMory:TRACe:CLient?
MMEMory:TRACe:CLient:STATe ON | OFF | 1 | 0
MMEMory:TRACe:CLient:STATe?
MMEMory:TRACe:OPERator "string"
MMEMory:TRACe:OPERator?
MMEMory:TRACe:OPERator:STATe ON | OFF | 1 | 0
MMEMory:TRACe:OPERator:STATe?
MMEMory:TRACe:PDEScription "string"
MMEMory:TRACe:PDEScription?
MMEMory:TRACe:PDEScriptionr:STATe?
MMEMory:TRACe:PDEScription:STATe ON | OFF | 1 | 0
MMEMory:TRACe:TITLe "string"
MMEMory:TRACe:TITLe?
MMEMory:TRACe:TITLe:STATe ON | OFF | 1 | 0
MMEMory:TRACe:TITLe:STATe?
OUTPut:ANALog OFF | SVIDeo | LOGVideo | LINVideo | DAUDio
OUTPut:ANALog?
OUTPut:ANALog:AUTO OFF | ON | 0 | 1
OUTPut:ANALog:AUTO?
OUTPut:AUX SIF | AIF | LOGVideo | OFF
OUTPut:AUX?
OUTPut:DBUS[1][:STATe] ON | OFF | 1 | 0
OUTPut:DBUS[1][:STATe]?
OUTPut:IQ:OUTPut IQ1 | IQ250 | OFF
OUTPut:IQ:OUTPut?
READ:APD[n]?
READ:DANalyzer [n]?
READ:FSCan[n]?
READ:MONitor[n]?
READ:SCHart [n]?
[:SENSe]:<measurement>:TRIGger:SOURce IF
[:SENSe]:<measurement>:TRIGger:SOURce
[:SENSe]:ACPR:TRIGger:SOURce
[:SENSe]:APD:ATTenuation:AUTO ON | OFF | 1 | 0
[:SENSe]:APD:ATTenuation:AUTO?
[:SENSe]:APD:DEMod AM | FM | PM | OFF
[:SENSe]:APD:DEMod?
[:SENSe]:APD:DEMod:FM:DEEMphasis OFF | US25 | US50 | US75 | US750
[:SENSe]:APD:DEMod:FM:DEEMphasis?
[:SENSe]:APD:GAIN:AUTO ON | OFF | 1 | 0
[:SENSe]:APD:GAIN:AUTO?
[:SENSe]:APD:MEAS ALL | MARKed
[:SENSe]:APD:MEAS?
[:SENSe]:APD:SWEep:TIME <time>
[:SENSe]:APD:SWEep:TIME?
[:SENSe]:APD:TRACe:ELIMit:RESet
[:SENSe]:BANDwidth|BWIDth[:RESolution] <freq>

```

```

[:SENSe]:BANDwidth|BWIDth[:RESolution] <freq>
[:SENSe]:BANDwidth|BWIDth[:RESolution]?
[:SENSe]:BANDwidth|BWIDth[:RESolution]?
[:SENSe]:BANDwidth|BWIDth[:RESolution]:AUTO OFF | ON | 0 | 1
[:SENSe]:BANDwidth|BWIDth[:RESolution]:AUTO OFF | ON | 0 | 1
[:SENSe]:BANDwidth|BWIDth[:RESolution]:AUTO?
[:SENSe]:BANDwidth|BWIDth[:RESolution]:AUTO?
[:SENSe]:BANDwidth|BWIDth[:RESolution]:TYPE DB3 | DB6 | IMPulse | NOISe
[:SENSe]:BANDwidth|BWIDth[:RESolution]:TYPE?
[:SENSe]:CORRection:BTS[:RF]:GAIN <rel_ampl>
[:SENSe]:CORRection:BTS[:RF]:GAIN?
[:SENSe]:CORRection:BTS[:RF]:LOSS <rel_ampl>
[:SENSe]:CORRection:BTS[:RF]:LOSS?
[:SENSe]:CORRection:CSET:ALL:DELeTe
[:SENSe]:CORRection:CSET:ALL[:STATE] ON | OFF | 1 | 0
[:SENSe]:CORRection:CSET:ALL[:STATE]?
[:SENSe]:CORRection:CSET[1]:ANTenna[:UNIT] GAUSs | PTESla | UVM | UAM | UA
| NOConversion
[:SENSe]:CORRection:CSET[1]:ANTenna[:UNIT]?
[:SENSe]:CORRection:CSET[1]|2|...|8:COMMeNt "text"
[:SENSe]:CORRection:CSET[1]|2|...|8:COMMeNt?
[:SENSe]:CORRection:CSET[1]|2|...|8:DATA <freq>, <ampl>, ...
[:SENSe]:CORRection:CSET[1]|2|...|8:DATA?
[:SENSe]:CORRection:CSET[1]|2|...|8:DATA:MERGe <freq>, <ampl>, ...
[:SENSe]:CORRection:CSET[1]|2|...|6:DELeTe
[:SENSe]:CORRection:CSET[1]|2|...|8:DESCription "text"
[:SENSe]:CORRection:CSET[1]|2|...|8:DESCription?
[:SENSe]:CORRection:CSET[1]|2|...|8[:STATE] ON | OFF | 1 | 0
[:SENSe]:CORRection:CSET[1]|2|...|8[:STATE]?
[:SENSe]:CORRection:CSET[1]|2|...|8:X:SPACing LINear | LOGarithmic
[:SENSe]:CORRection:CSET[1]|2|...|8:X:SPACing?
[:SENSe]:CORRection:IMPedance[:INPut][:MAGNitude] 50 | 75
[:SENSe]:CORRection:IMPedance[:INPut][:MAGNitude]?
[:SENSe]:CORRection:IQ:I:GAIN <rel_ampl>
[:SENSe]:CORRection:IQ:I:GAIN?
[:SENSe]:CORRection:IQ:I|Q:ATTenuation <rel_ampl>
[:SENSe]:CORRection:IQ:I|Q:ATTenuation?
[:SENSe]:CORRection:IQ:I|Q:ATTenuation:RATio <real>
[:SENSe]:CORRection:IQ:I|Q:ATTenuation:RATio?
[:SENSe]:CORRection:IQ[:I]:SKEW <seconds>
[:SENSe]:CORRection:IQ[:I]:SKEW?
[:SENSe]:CORRection:IQ:Q:GAIN <rel_ampl>
[:SENSe]:CORRection:IQ:Q:GAIN?
[:SENSe]:CORRection:IQ:Q:SKEW <seconds>
[:SENSe]:CORRection:IQ:Q:SKEW?
[:SENSe]:CORRection:MS[:RF]:GAIN <rel_ampl>
[:SENSe]:CORRection:MS[:RF]:GAIN?
[:SENSe]:CORRection:MS[:RF]:LOSS <rel_ampl>
[:SENSe]:CORRection:MS[:RF]:LOSS?
[:SENSe]:CORRection:NOISe:FLOOr ON | OFF | 1 | 0
[:SENSe]:CORRection:NOISe:FLOOr?
[:SENSe]:CORRection:OFFSet[:MAGNitude]
[:SENSe]:CORRection:SA[:RF]:GAIN <rel_ampl>

```

```

[:SENSE]:CORREction:SA[:RF]:GAIN?
[:SENSE]:DANalyzer:CLICk:CORREction <rel_amptd>
[:SENSE]:DANalyzer:CLICk:CORREction?
[:SENSE]:DANalyzer:CLICk:COUNT <integer>
[:SENSE]:DANalyzer:CLICk:COUNT?
[:SENSE]:DANalyzer:CLICk:COUNT:STATE ON | OFF | 1 | 0
[:SENSE]:DANalyzer:CLICk:COUNT:STATE?
[:SENSE]:DANalyzer:CRATE?
[:SENSE]:DANalyzer:CRATE:<integer>
[:SENSE]:DANalyzer:CRATE:TYPE MEASured | USER
[:SENSE]:DANalyzer:CRATE:TYPE?
[:SENSE]:DANalyzer:FREQuency F150KHZ | F500KHZ | F1400KHZ | F30MHZ |
MANual
[:SENSE]:DANalyzer:FREQuency?
[:SENSE]:DANalyzer:FREQuency:MANual <freq>
[:SENSE]:DANalyzer:FREQuency:MANual?
[:SENSE]:DANalyzer:POWER[:RF]:ATTenuation <rel_amptd>
[:SENSE]:DANalyzer:POWER[:RF]:ATTenuation?
[:SENSE]:DANalyzer:POWER[:RF]:ATTenuation:AUTO OFF | ON | 0 | 1
[:SENSE]:DANalyzer:POWER[:RF]:ATTenuation:AUTO?
[:SENSE]:DEMod
[:SENSE]:DEMod?
[:SENSE]:DETEctor[1]|2|3[:FUNction] APEak | NEGative | POSitive | SAMPlE |
RMS | AVERage | QPEak | CAVERage | CRMS
[:SENSE]:DETEctor[1]|2|3[:FUNction] ?
[:SENSE]:EMC:STANDard:PRESet NONE | CISPr | MIL
[:SENSE]:EMC:STANDard:PRESet?
[:SENSE]:EMC:STANDard[:SElect] NONE | CISPr | MIL
[:SENSE]:EMC:STANDard[:SElect]?
[:SENSE]:FEED IQ | IONLy | QONLy
[:SENSE]:FEED RF | AIQ | EMIXer
[:SENSE]:FEED AREFERENCE
[:SENSE]:FEED?
[:SENSE]:FEED?
[:SENSE]:FEED:AREFERENCE REF50 | REF4800 | OFF
[:SENSE]:FEED:AREFERENCE?
[:SENSE]:FEED:IQ:TYPE IQ | IONLy | QONLy
[:SENSE]:FEED:IQ:TYPE?
[:SENSE]:FEED:RF:PORT[:INPut] RFIN | RFIN2 | RFIO1 | RFIO2 | RFIO3 | RFIO4
[:SENSE]:FEED:RF:PORT[:INPut]?
[:SENSE]:FREQuency:CENTer <frequency>
[:SENSE]:FREQuency:CENTer ?
[:SENSE]:FREQuency:CENTer:STEP:AUTO OFF | ON | 0 | 1
[:SENSE]:FREQuency:CENTer:STEP:AUTO?
[:SENSE]:FREQuency:CENTer:STEP[:INCRement] <freq>
[:SENSE]:FREQuency:CENTer:STEP[:INCRement]?
[:SENSE]:FREQuency:MIDSpan <freq>
[:SENSE]:FREQuency:MIDSpan?
[:SENSE]:FREQuency:MODE CW | FIXEd | SWEEp | SCAN | TDOMain
[:SENSE]:FREQuency:MODE?
[:SENSE]:FREQuency:SPAN <frequency>
[:SENSE]:FREQuency:SPAN?
[:SENSE]:FREQuency:START <frequency>

```

3 Programming the Analyzer  
List of SCPI Commands

```

[:SENSe]:FREQuency:START?
[:SENSe]:FREQuency:START:AUTO ON | OFF | 1 | 0
[:SENSe]:FREQuency:START:AUTO?
[:SENSe]:FREQuency:STOP <frequency>
[:SENSe]:FREQuency:STOP?
[:SENSe]:FREQuency:STOP:AUTO ON | OFF | 1 | 0 | 0 | 1
[:SENSe]:FREQuency:STOP:AUTO?
[:SENSe]:FSCan:DEMod AM | FM | PM | OFF
[:SENSe]:FSCan:DEMod?
[:SENSe]:FSCan:DEMod:FM:DEEMphasis OFF | US25 | US50 | US75 | US750
[:SENSe]:FSCan:DEMod:FM:DEEMphasis?
[:SENSe]:FSCan:DETEctor:TRACe[1] | 2 | 3POSitive | QPEak | EAVERage |
RAVERage | AVERage | NEGative
[:SENSe]:FSCan:DETEctor:TRACe[1]|2|3?
[:SENSe]:FSCan:FINAl:ATTenuation:AUTO ON | OFF | 1 | 0
[:SENSe]:FSCan:FINAl:ATTenuation:AUTO?
[:SENSe]:FSCan:FINAl:ATTenuation:PROTEction
[:SENSe]:FSCan:FINAl:DETEctor[1] | 2 | 3POSitive | QPEak | EAVERage |
RAVERage | AVERage | NEGative | OFF
[:SENSe]:FSCan:FINAl:DETEctor[1]|2|3?
[:SENSe]:FSCan:FINAl:DETEctor[1]|2|3:DWELL <dwelTime>
[:SENSe]:FSCan:FINAl:DETEctor[1]|2|3:DWELL?
[:SENSe]:FSCan:FINAl:DETEctor[1]|2|3:LDELta <limitNum>
[:SENSe]:FSCan:FINAl:DETEctor[1]|2|3:LDELta?
[:SENSe]:FSCan:FINAl:GAIN:AUTO ON | OFF | 1 | 0
[:SENSe]:FSCan:FINAl:GAIN:AUTO?
[:SENSe]:FSCan:RANGE[1]|2|...|10:PRESet CISA | CISB | CISC | CISD | CISCd
| CISE | MIL1K | MIL10K | MIL150K | MIL30M | MIL1G | MILGT1G
[:SENSe]:FSCan:RANGE[1]|2|...|10:SANalyzer[:IMMediate]
[:SENSe]:FSCan:SCAN:ABORT
[:SENSe]:FSCan:SCAN[1]|2|...|10:BANDwidth[:RESolution] <freq>
[:SENSe]:FSCan:SCAN[1]|2|...|10:BANDwidth[:RESolution]?
[:SENSe]:FSCan:SCAN[1]|2|...|10:BANDwidth[:RESolution]:AUTO ON | OFF | 1 |
0
[:SENSe]:FSCan:SCAN[1]|2|...|10:BANDwidth[:RESolution]:AUTO?
[:SENSe]:FSCan:SCAN:CONTrol SDWell | STPoints
[:SENSe]:FSCan:SCAN:CONTrol?
[:SENSe]:FSCan:SCAN[1]|2|...|10:FEED:RF:PORT[:INPut] RFIN | RFIN2
[:SENSe]:FSCan:SCAN[1]|2|...|10:FEED:RF:PORT[:INPut]?
[:SENSe]:FSCan:SCAN[1]|2|...|10:INPut:ATTenuation <rel_ampl>
[:SENSe]:FSCan:SCAN[1]|2|...|10:INPut:ATTenuation?
[:SENSe]:FSCan:SCAN[1]|2|...|10:INPut:ATTenuation:AUTO ON | OFF | 1 | 0
[:SENSe]:FSCan:SCAN[1]|2|...|10:INPut:ATTenuation:AUTO
[:SENSe]:FSCan:SCAN[1]|2|...|10:LPCT <integer>
[:SENSe]:FSCan:SCAN[1]|2|...|10:LPCT?
[:SENSe]:FSCan:SCAN[1]|2|...|10:POINTs <integer>
[:SENSe]:FSCan:SCAN[1]|2|...|10:POINTs ?
[:SENSe]:FSCan:SCAN[1]|2|...|10:POINTs:AUTO ON | OFF | 1 | 0
[:SENSe]:FSCan:SCAN[1]|2|...|10:POINTs:AUTO?
[:SENSe]:FSCan:SCAN[1]|2|...|10:POWER:GAIN:AUTO ON | OFF | 1 | 0
[:SENSe]:FSCan:SCAN[1]|2|...|10:POWER:GAIN:AUTO?
[:SENSe]:FSCan:SCAN[1]|2|...|10:POWER:GAIN:BAND LOW | FULL

```



```

[:SENSe]:FSCan:SCAN[1]|2|...|10:POWer:GAIN:BAND?
[:SENSe]:FSCan:SCAN[1]|2|...|10:POWer:GAIN[:STATE] ON | OFF | 1 | 0
[:SENSe]:FSCan:SCAN[1]|2|...|10:POWer:GAIN[:STATE]?
[:SENSe]:FSCan:SCAN[1]|2|...|10:PRBW <integer>
[:SENSe]:FSCan:SCAN[1]|2|...|10:PRBW?
[:SENSe]:FSCan:SCAN[1]|2|...|10:RULeS PRBW | LPCT
[:SENSe]:FSCan:SCAN[1]|2|...|10:RULeS?
[:SENSe]:FSCan:SCAN[1]|2|...|10:STARt <freq>
[:SENSe]:FSCan:SCAN[1]|2|...|10:STARt?
[:SENSe]:FSCan:SCAN[1]|2|...|10:STATe ON | OFF | 1 | 0
[:SENSe]:FSCan:SCAN[1]|2|...|10:STATe?
[:SENSe]:FSCan:SCAN[1]|2|...|10:STEP <freq>
[:SENSe]:FSCan:SCAN[1]|2|...|10:STEP?
[:SENSe]:FSCan:SCAN[1]|2|...|10:STEP:AUTO ON | OFF | 1 | 0
[:SENSe]:FSCan:SCAN[1]|2|...|10:STEP:AUTO?
[:SENSe]:FSCan:SCAN[1]|2|...|10:STIME <time>
[:SENSe]:FSCan:SCAN[1]|2|...|10:STIME?
[:SENSe]:FSCan:SCAN[1]|2|...|10:STIME:AUTO ON | OFF | 1 | 0
[:SENSe]:FSCan:SCAN[1]|2|...|10:STIME:AUTO?
[:SENSe]:FSCan:SCAN[1]|2|...|10:STOP <freq>
[:SENSe]:FSCan:SCAN[1]|2|...|10:STOP?
[:SENSe]:FSCan:SCAN:TDOMain:TYPE IMPulse | CWave
[:SENSe]:FSCan:SCAN:TDOMain:TYPE?
[:SENSe]:FSCan:SCAN[1]|2|...|10:TIME <time>
[:SENSe]:FSCan:SCAN[1]|2|...|10:TIME?
[:SENSe]:FSCan:SCAN[1]|2|...|10:TIME:AUTO ON | OFF | 1 | 0
[:SENSe]:FSCan:SCAN[1]|2|...|10:TIME:AUTO?
[:SENSe]:FSCan:SCAN:TYPE SMOoth | DISCrete | TDOMain
[:SENSe]:FSCan:SCAN:TYPE STEPped | SWEpt | TDOMain
[:SENSe]:FSCan:SCAN:TYPE?
[:SENSe]:FSCan:SEARch:MODE PONLy | PLIMits | SLIMits
[:SENSe]:FSCan:SEARch:MODE?
[:SENSe]:FSCan:SEARch:PEAK:COUNT <integer>
[:SENSe]:FSCan:SEARch:PEAK:COUNT?
[:SENSe]:FSCan:SEARch:PEAK:COUNT:STATe ON | OFF | 1 | 0
[:SENSe]:FSCan:SEARch:PEAK:COUNT:STATe?
[:SENSe]:FSCan:SEARch:SUBRange:COUNT <integer>
[:SENSe]:FSCan:SEARch:SUBRange:COUNT?
[:SENSe]:FSCan:SEQuence SCAN | SEARch | SSAMeasure | SASearch | SAMeasure
| REMeasure
[:SENSe]:FSCan:SEQuence?
[:SENSe]:FSCan:SEQuence:REMeasure CURRent | MARKed | ALL
[:SENSe]:FSCan:SEQuence:REMeasure?
[:SENSe]:FSCan:SLISt:COMMeNt <integer>, "string"
[:SENSe]:FSCan:SLISt:COMMeNt? <integer>
[:SENSe]:FSCan:SLISt:COUPle:METER ON | OFF | 1 | 0
[:SENSe]:FSCan:SLISt:COUPle:METER?
[:SENSe]:FSCan:SWEEp:COUNT <integer>
[:SENSe]:FSCan:SWEEp:COUNT?
[:SENSe]:METER:ATTenuation:AUTO ON | OFF | 1 | 0
[:SENSe]:METER:ATTenuation:AUTO?
[:SENSe]:METER:ATTenuation:PROTection ON | OFF | 1 | 0
[:SENSe]:METER:ATTenuation:PROTection?

```

### 3 Programming the Analyzer

#### List of SCPI Commands

```
[ :SENSe]:METer[1]|2|3:DETEctor POSitive | QPEak | EAverage | RAverage |
AVERage | NEGative
[:SENSe]:METer[1]|2|3:DETEctor?
[:SENSe]:METer:DETEctor:DWELL <time>
[:SENSe]:METer:DETEctor:DWELL?
[:SENSe]:METer:GAIN:AUTO ON | OFF | 1 | 0
[:SENSe]:METer:GAIN:AUTO?
[:SENSe]:METer:PHOLD:ADJustable <time>
[:SENSe]:METer:PHOLD:ADJustable?
[:SENSe]:METer:PHOLD:RESet
[:SENSe]:METer:PHOLD:TYPE INFinite | ADJustable
[:SENSe]:METer:PHOLD:TYPE?
[:SENSe]:MONitor:DEMod AM | FM | OFF
[:SENSe]:MONitor:DEMod?
[:SENSe]:MONitor:DEMod:FM:DEEMphasis OFF | US25 | US50 | US75 | US750
[:SENSe]:MONitor:DEMod:FM:DEEMphasis?
[:SENSe]:MONitor:FREQuency:SPAN <frequency>
[:SENSe]:MONitor:FREQuency:SPAN?
[:SENSe]:MONitor:FREQuency:SPAN:PREVious
[:SENSe]:MONitor:SPECTrum:BANDwidth[:RESolution] <freq>
[:SENSe]:MONitor:SPECTrum:BANDwidth[:RESolution]?
[:SENSe]:POWER[:RF]:ATTenuation <rel_ampl>
[:SENSe]:POWER[:RF]:ATTenuation?
[:SENSe]:POWER[:RF]:GAIN:BAND LOW | FULL
[:SENSe]:POWER[:RF]:GAIN:BAND?
[:SENSe]:POWER[:RF]:GAIN[:STATE] OFF | ON | 0 | 1
[:SENSe]:POWER[:RF]:GAIN[:STATE]?
[:SENSe]:POWER[:RF]:MMW:PADJust
[:SENSe]:POWER[:RF]:MW:PADJust
[:SENSe]:POWER[:RF]:PADJust <freq>
[:SENSe]:POWER[:RF]:PADJust?
[:SENSe]:POWER[:RF]:PADJust:PRESelector MWAVE | MMWave | EXTERNAL
[:SENSe]:POWER[:RF]:PADJust:PRESelector?
[:SENSe]:POWER[:RF]:PCenter
[:SENSe]:POWER[:RF]:RFPSelector[:STATE] 1 | 0 | ON | OFF
[:SENSe]:POWER[:RF]:RFPSelector[:STATE]?
[:SENSe]:ROSCillator:BANDwidth WIDE | NARROW
[:SENSe]:ROSCillator:BANDwidth?
[:SENSe]:ROSCillator:EXTernal:FREQuency <freq>
[:SENSe]:ROSCillator:EXTernal:FREQuency?
[:SENSe]:ROSCillator:SOURce INTernal | EXTERNAL
[:SENSe]:ROSCillator:SOURce?
[:SENSe]:ROSCillator:SOURce:TYPE INTernal | EXTERNAL | SENSE | PULSE
[:SENSe]:ROSCillator:SOURce:TYPE?
[:SENSe]:SCAN[1]|2|...|10:BANDwidth[:RESolution]
[:SENSe]:SCAN[1]|2|...|10:INPut:ATTenuation
[:SENSe]:SCAN[1]|2|...|10:INPut:ATTenuation:AUTO
[:SENSe]:SCAN[1]|2|...|10:INPut:ATTenuation:AUTO
[:SENSe]:SCAN[1]|2|...|10:INPut:GAIN:AUTO
[:SENSe]:SCAN[1]|2|...|10:INPut:GAIN:AUTO
[:SENSe]:SCAN[1]|2|...|10:INPut:GAIN[:STATE] ON | OFF | 1 | 0
[:SENSe]:SCAN[1]|2|...|10:INPut:GAIN[:STATE]?
[:SENSe]:SCAN[1]|2|...|10:INPut:TYPE
```

```

[:SENSE]:SCAN[1]|2|...|10:INPut:TYPE?
[:SENSE]:SCAN:RANGes[:COUNT] <integer>
[:SENSE]:SCAN:RANGes[:COUNT]?
[:SENSE]:SCAN[1]|2|...|10:START
[:SENSE]:SCAN[1]|2|...|10:STEP
[:SENSE]:SCAN[1]|2|...|10:STOP
[:SENSE]:SCAN[1]|2|...|10:TIME
[:SENSE]:SCHart:ABORT
[:SENSE]:SCHart:DEMod AM | FM | PM | OFF
[:SENSE]:SCHart:DEMod?
[:SENSE]:SCHart:DEMod:FM:DEEMphasis OFF | US25 | US50 | US75 | US750
[:SENSE]:SCHart:DEMod:FM:DEEMphasis?
SENSE1|SENSE2:DEMod
SENSE1|SENSE2:DEMod OFF | AM | FM
SENSE1|SENSE2:DETEctor[1]|2|3[:FUNction]
SENSE1|SENSE2:FREQuency:MODE STEPped | SWEpt | TDOMain
SENSE1|SENSE2:FREQuency:START
SENSE1|SENSE2:FREQuency:STOP
SENSE1|SENSE2:SCAN[1]|2|...|10:BANDwidth[:RESolution]
SENSE1|SENSE2:SCAN[1]|2|...|10:INPut:ATTenuation
SENSE1|SENSE2:SCAN[1]|2|...|10:INPut:ATTenuation:AUTO
SENSE1|SENSE2:SCAN[1]|2|...|10:INPut:ATTenuation:AUTO
SENSE1|SENSE2:SCAN[1]|2|...|10:INPut:GAIN:AUTO
SENSE1|SENSE2:SCAN[1]|2|...|10:INPut:GAIN:AUTO
SENSE1|SENSE2:SCAN[1]|2|...|10:INPut:GAIN[:STATE]
SENSE1|SENSE2:SCAN[1]|2|...|10:INPut:TYPE INPUT1 | INPUT2
SENSE1|SENSE2:SCAN[1]|2|...|10:INPut:TYPE?
SENSE1|SENSE2:SCAN:RANGes[:COUNT]
SENSE1|SENSE2:SCAN[1]|2|...|10:START
SENSE1|SENSE2:SCAN[1]|2|...|10:STEP
SENSE1|SENSE2:SCAN[1]|2|...|10:STOP
SENSE1|SENSE2:SCAN[1]|2|...|10:TIME
SENSE1|SENSE2|[SENSE]:BANDwidth|BWIDth:IF
SENSE1|SENSE2|[SENSE]:BANDwidth|BWIDth[:RESolution]
SENSE1|SENSE2|[SENSE]:BANDwidth|BWIDth[:RESolution]
SENSE1|SENSE2|[SENSE]:BANDwidth|BWIDth[:RESolution]
SENSE1|SENSE2|[SENSE]:BANDwidth|BWIDth[:RESolution]:TYPE NORMAL | PULSe
SENSE1|SENSE2|[SENSE]:BANDwidth|BWIDth[:RESolution]:TYPE?
SENSE1|SENSE2|[SENSE]:DETEctor:RECEiver[:FUNction]
POSitive|NEGative|RMS|AVERage|QPEak|CAVERage|CRMS, ...
SENSE1|SENSE2|[SENSE]:DETEctor:RECEiver[:FUNction]?
SENSE1|SENSE2|[:SENSE]:FMEasurement:LISN:FILTer:HPAS[:STATE] ON | OFF | 1
| 0
SENSE1|SENSE2|[:SENSE]:FMEasurement:LISN:FILTer:HPAS[:STATE]?
SENSE1|SENSE2|[:SENSE]:FMEasurement:LISN:PEARth GROunded | FLOating,
[GROunded | FLOating]
SENSE1|SENSE2|[:SENSE]:FMEasurement:LISN:PEARth?
SENSE1|SENSE2|[SENSE]:FMEasurement:LISN:PHASe L1 | L2 | L3 | N[, L1 | L2
| L3 | N], .]
SENSE1|SENSE2|[SENSE]:FMEasurement:LISN:PHASe L1 | L2 | L3 | N[, L1 | L2
| L3 | N], .]

```

```
SENSe1|SENSe2|[SENSe]:FMEasurement:LISN[:TYPE] FOURphase | ESH2Z5 | ENV216
| OFF
SENSe1|SENSe2|[SENSe]:FMEasurement:LISN[:TYPE]?
SENSe1|SENSe2|[SENSe]:FREQuency:CENTer
SENSe1|SENSe2|[SENSe]:FREQuency:FIXed
SENSe1|SENSe2|[SENSe]:SWEep:TIME
SENSe1|SENSe2:SWEep:COUNT
[:SENSe]:SLISt:COMMeNt <integer>, "string"
[:SENSe]:SLISt:COMMeNt? <integer>
[:SENSe]:SWEep:COUNT
STATus:OPERation:CONDition?
STATus:OPERation:ENABle <integer>
STATus:OPERation:ENABle?
STATus:OPERation[:EVENT]?
STATus:OPERation:NTRansition <integer>
STATus:OPERation:NTRansition?
STATus:OPERation:PTRansition <integer>
STATus:OPERation:PTRansition?
STATus:PRESet
STATus:QUEStionable:CALibration:CONDition?
STATus:QUEStionable:CALibration:ENABle <integer>
STATus:QUEStionable:CALibration:ENABle?
STATus:QUEStionable:CALibration[:EVENT]?
STATus:QUEStionable:CALibration:EXTended:FAILure:CONDition?
STATus:QUEStionable:CALibration:EXTended:FAILure:ENABle <integer>
STATus:QUEStionable:CALibration:EXTended:FAILure:ENABle?
STATus:QUEStionable:CALibration:EXTended:FAILure[:EVENT]?
STATus:QUEStionable:CALibration:EXTended:FAILure:NTRansition <integer>
STATus:QUEStionable:CALibration:EXTended:FAILure:NTRansition?
STATus:QUEStionable:CALibration:EXTended:FAILure:PTRansition <integer>
STATus:QUEStionable:CALibration:EXTended:FAILure:PTRansition?
STATus:QUEStionable:CALibration:EXTended:NEEDed:CONDition?
STATus:QUEStionable:CALibration:EXTended:NEEDed:ENABle <integer>
STATus:QUEStionable:CALibration:EXTended:NEEDed:ENABle?
STATus:QUEStionable:CALibration:EXTended:NEEDed[:EVENT]?
STATus:QUEStionable:CALibration:EXTended:NEEDed:NTRansition <integer>
STATus:QUEStionable:CALibration:EXTended:NEEDed:NTRansition?
STATus:QUEStionable:CALibration:EXTended:NEEDed:PTRansition <integer>
STATus:QUEStionable:CALibration:EXTended:NEEDed:PTRansition?
STATus:QUEStionable:CALibration:NTRansition <integer>
STATus:QUEStionable:CALibration:NTRansition?
STATus:QUEStionable:CALibration:PTRansition <integer>
STATus:QUEStionable:CALibration:PTRansition?
STATus:QUEStionable:CALibration:SKIPPed:CONDition?
STATus:QUEStionable:CALibration:SKIPPed:ENABle <integer>
STATus:QUEStionable:CALibration:SKIPPed:ENABle?
STATus:QUEStionable:CALibration:SKIPPed[:EVENT]?
STATus:QUEStionable:CALibration:SKIPPed:NTRansition <integer>
STATus:QUEStionable:CALibration:SKIPPed:NTRansition?
STATus:QUEStionable:CALibration:SKIPPed:PTRansition <integer>
STATus:QUEStionable:CALibration:SKIPPed:PTRansition?
STATus:QUEStionable:CONDition?
STATus:QUEStionable:ENABle <integer>
```

```
STATUS:QUESTIONABLE:ENABLE?
STATUS:QUESTIONABLE[:EVENT]?
STATUS:QUESTIONABLE:FREQUENCY:CONDITION?
STATUS:QUESTIONABLE:FREQUENCY:ENABLE <integer>
STATUS:QUESTIONABLE:FREQUENCY:ENABLE?
STATUS:QUESTIONABLE:FREQUENCY[:EVENT]?
STATUS:QUESTIONABLE:FREQUENCY:NTRANSITION <integer>
STATUS:QUESTIONABLE:FREQUENCY:NTRANSITION?
STATUS:QUESTIONABLE:FREQUENCY:PTRANSITION <integer>
STATUS:QUESTIONABLE:FREQUENCY:PTRANSITION?
STATUS:QUESTIONABLE:INTEGRITY:CONDITION?
STATUS:QUESTIONABLE:INTEGRITY:ENABLE <integer>
STATUS:QUESTIONABLE:INTEGRITY:ENABLE?
STATUS:QUESTIONABLE:INTEGRITY[:EVENT]?
STATUS:QUESTIONABLE:INTEGRITY:NTRANSITION <integer>
STATUS:QUESTIONABLE:INTEGRITY:NTRANSITION?
STATUS:QUESTIONABLE:INTEGRITY:PTRANSITION <integer>
STATUS:QUESTIONABLE:INTEGRITY:PTRANSITION?
STATUS:QUESTIONABLE:INTEGRITY:SIGNAL:CONDITION?
STATUS:QUESTIONABLE:INTEGRITY:SIGNAL:ENABLE <integer>
STATUS:QUESTIONABLE:INTEGRITY:SIGNAL:ENABLE?
STATUS:QUESTIONABLE:INTEGRITY:SIGNAL[:EVENT]?
STATUS:QUESTIONABLE:INTEGRITY:SIGNAL:NTRANSITION <integer>
STATUS:QUESTIONABLE:INTEGRITY:SIGNAL:NTRANSITION?
STATUS:QUESTIONABLE:INTEGRITY:SIGNAL:PTRANSITION <integer>
STATUS:QUESTIONABLE:INTEGRITY:SIGNAL:PTRANSITION?
STATUS:QUESTIONABLE:INTEGRITY:UNCALIBRATED:CONDITION?
STATUS:QUESTIONABLE:INTEGRITY:UNCALIBRATED:ENABLE
STATUS:QUESTIONABLE:INTEGRITY:UNCALIBRATED:ENABLE?
STATUS:QUESTIONABLE:INTEGRITY:UNCALIBRATED[:EVENT]?
STATUS:QUESTIONABLE:INTEGRITY:UNCALIBRATED:NTRANSITION <integer>
STATUS:QUESTIONABLE:INTEGRITY:UNCALIBRATED:NTRANSITION?
STATUS:QUESTIONABLE:INTEGRITY:UNCALIBRATED:PTRANSITION <integer>
STATUS:QUESTIONABLE:INTEGRITY:UNCALIBRATED:PTRANSITION?
STATUS:QUESTIONABLE:NTRANSITION <integer>
STATUS:QUESTIONABLE:NTRANSITION?
STATUS:QUESTIONABLE:POWER:CONDITION?
STATUS:QUESTIONABLE:POWER:ENABLE <integer>
STATUS:QUESTIONABLE:POWER:ENABLE?
STATUS:QUESTIONABLE:POWER[:EVENT]?
STATUS:QUESTIONABLE:POWER:NTRANSITION <integer>
STATUS:QUESTIONABLE:POWER:NTRANSITION?
STATUS:QUESTIONABLE:POWER:PTRANSITION <integer>
STATUS:QUESTIONABLE:POWER:PTRANSITION?
STATUS:QUESTIONABLE:PTRANSITION <integer>
STATUS:QUESTIONABLE:PTRANSITION?
STATUS:QUESTIONABLE:TEMPERATURE:CONDITION?
STATUS:QUESTIONABLE:TEMPERATURE:ENABLE <integer>
STATUS:QUESTIONABLE:TEMPERATURE:ENABLE?
STATUS:QUESTIONABLE:TEMPERATURE[:EVENT]?
STATUS:QUESTIONABLE:TEMPERATURE:NTRANSITION <integer>
STATUS:QUESTIONABLE:TEMPERATURE:NTRANSITION?
STATUS:QUESTIONABLE:TEMPERATURE:PTRANSITION <integer>
```

```

STATus:QUEStionable:TEMPerature:PTRansition?
SYSTem:APPLication:CATalog[:NAME]?
SYSTem:APPLication:CATalog[:NAME]:COUNT?
SYSTem:APPLication:CATalog:OPTion? <model>
SYSTem:APPLication:CATalog:REVision? <model>
SYSTem:APPLication[:CURRent][:NAME]?
SYSTem:APPLication[:CURRent]:OPTion?
SYSTem:APPLication[:CURRent]:REVision?
SYSTem:COMMunicate:GPIB[1][:SELF]:ADDRes <integer>
SYSTem:COMMunicate:GPIB[1][:SELF]:ADDRes?
SYSTem:COMMunicate:GPIB[1][:SELF]:CONTROLLER[:ENABLE] ON | OFF | 0 | 1
SYSTem:COMMunicate:GPIB[1][:SELF]:CONTROLLER[:ENABLE]?
SYSTem:COMMunicate:LAN:SCPI:HISLip:ENABLE OFF | ON | 0 | 1
SYSTem:COMMunicate:LAN:SCPI:HISLip:ENABLE?
SYSTem:COMMunicate:LAN:SCPI:SICL:ENABLE OFF | ON | 0 | 1
SYSTem:COMMunicate:LAN:SCPI:SICL:ENABLE?
SYSTem:COMMunicate:LAN:SCPI:SOCKET:CONTROl?
SYSTem:COMMunicate:LAN:SCPI:SOCKET:ENABLE OFF | ON | 0 | 1
SYSTem:COMMunicate:LAN:SCPI:SOCKET:ENABLE?
SYSTem:COMMunicate:LAN:SCPI:TELNet:ENABLE OFF | ON | 0 | 1
SYSTem:COMMunicate:LAN:SCPI:TELNet:ENABLE?
SYSTem:COMMunicate:USB:CONNEction?
SYSTem:COMMunicate:USB:PACKets?
SYSTem:COMMunicate:USB:STATus?
SYSTem:CONFigure[:SYSTem]?
SYSTem:CSYStem?
SYSTem:DATE "<year>, <month>, <day>"
SYSTem:DATE?
SYSTem:DEFault [ALL] | ALIGn | INPut | MISC | MODes | PON
SYSTem:ERRor[:NEXT]?
SYSTem:ERRor:OVERload[:STATE] 0 | 1 | OFF | ON
SYSTem:ERRor:VERBoSe OFF | ON | 0 | 1
SYSTem:ERRor:VERBoSe?
SYSTem:HELP:HEADers?
SYSTem:HID?
SYSTem:IDN <string>
SYSTem:IDN?
SYSTem:KLOCK OFF | ON | 0 | 1
SYSTem:KLOCK?
SYSTem:LKEY <"OptionInfo">, <"LicenseInfo">
SYSTem:LKEY? <"OptionInfo">
SYSTem:LKEY:DELeTe <"OptionInfo">, <"LicenseInfo">
SYSTem:LKEY:LIST?
SYSTem:MRELay:COUNT?
SYSTem:OPTions?
SYSTem:PDOWN [NORMAL | FORCe]
SYSTem:PON:APPLication:LLIST <stringofINSTRument:SElectnames>
SYSTem:PON:APPLication:LLIST?
SYSTem:PON:APPLication:VMEMory[:AVAILable]?
SYSTem:PON:APPLication:VMEMory:TOTAL?
SYSTem:PON:APPLication:VMEMory:USED?
SYSTem:PON:APPLication:VMEMory:USED:NAME? <INSTRument:SElectname>
SYSTem:PON:ETIME?

```

```

SYSTem:PON:MODE SA | BASIC | ADEMOD | NFIGURE | PNOISE | CDMA2K | TDSCDMA
| VSA | VSA89601 | WCDMA | WIMAXOFDMA
SYSTem:PON:MODE?
SYSTem:PON:TIME?
SYSTem:PON:TYPE MODE | USER | LAST
SYSTem:PON:TYPE PRESet
SYSTem:PON:TYPE?
SYSTem:PRESet
SYSTem:PRESet:USER
SYSTem:PRESet:USER:ALL
SYSTem:PRESet:USER:SAVE
SYSTem:PRINT:THEME TDCOLOR | TDMonochrome | FCOLOR | FMONochrome
SYSTem:PRINT:THEME?
SYSTem:PUP:PROcESS
SYSTem:SECurity:USB:WPRotect[:ENABLE] ON | OFF | 0 | 1
SYSTem:SECurity:USB:WPRotect[:ENABLE]?
SYSTem:SHOW OFF | ERRor | SYSTem | HARDware | LXI | HWStatistics |
ALIGNment | SOFTware | CAPplication
SYSTem:SHOW?
SYSTem:TEMPerature:HEXTreme?
SYSTem:TEMPerature:LEXTreme?
SYSTem:TIME "<hour>, <minute>, <second>"
SYSTem:TIME?
SYSTem:VERSIon?
TRACe:APD[:DATA]? MEAS | MEAS2 | ELIMit
TRACe[1]|2|3:APD:DISPlay[:STATE] ON | OFF | 0 | 1
TRACe[1]|2|3:APD:DISPlay[:STATE]?
TRACe[1]|2|3:APD:UPDate[:STATE] ON | OFF | 0 | 1
TRACe[1]|2|3:APD:UPDate[:STATE]?
TRACe[:DATA]
TRACe[:DATA] TRACE1 | TRACE2 | TRACE3
TRACe[:DATA]? TRACE1 | TRACE2 | TRACE3
TRACe[:DATA]?
TRACe[:DATA]?
TRACe:FEED:CONTRol ALWAYS | NEVER
TRACe:FEED:CONTRol?
TRACe:FSCan:COpy TRACE1|TRACE2|TRACE3, ...
TRACe:FSCan[:DATA] TRACE1 | TRACE2 | TRACE3, <data>
TRACe:FSCan[:DATA]? TRACE1 | TRACE2 | TRACE3 | SCAN | SINGLE
TRACe[1]|2|3:FSCan:DISPlay ON | OFF | 1 | 0
TRACe[1]|2|3:FSCan:DISPlay ?
TRACe:FSCan:EXCHange TRACE1|TRACE2|TRACE3, ...
TRACe[1]|2|3:FSCan:UPDate ON | OFF | 1 | 0
TRACe[1]|2|3:FSCan:UPDate?
TRACe:MONitor:COpy TRACE1|TRACE2|TRACE3, ...
TRACe:MONitor[:DATA] TRACE1 | TRACE2 | TRACE3, <data>
TRACe:MONitor[:DATA]? TRACE1 | TRACE2 | TRACE3 | SINGLE
TRACe[1]|2|3:MONitor:DISPlay[:STATE] ON | OFF | 0 | 1
TRACe[1]|2|3:MONitor:DISPlay[:STATE]?
TRACe[1]|2|3:MONitor:TYPE WRITe | AVERAge | MAXHold | MINHold
TRACe[1]|2|3:MONitor:TYPE?
TRACe[1]|2|3:MONitor:UPDate[:STATE] ON | OFF | 0 | 1
TRACe[1]|2|3:MONitor:UPDate[:STATE]?

```

### 3 Programming the Analyzer

#### List of SCPI Commands

```
TRACe:Schart:CLear TRACE1 | TRACE2 | TRACE3
TRACe:Schart:CLear:ALL
TRIGger:<measurement>[:SEQuence]:IQ:SOURce EXTernal1 | EXTernal2 |
IMMediate | IQMag | IDEMod | QDEMod | IINPut | QINPut | AIQMag
TRIGger:<measurement>[:SEQuence]:IQ:SOURce?
TRIGger:<measurement>[:SEQuence]:RF:SOURce EXTernal1 | EXTernal2 |
IMMediate | LINE | FRAME | RFBurst | VIdEO | IF | ALARm | LAN | TV
TRIGger:<measurement>[:SEQuence]:RF:SOURce?
TRIGger:<measurement>[:SEQuence]:SOURce EXTernal1 | EXTernal2 | IMMediate
| LINE | FRAME | RFBurst | VIdEO | IF | ALARm | LAN | IQMag | IDEMod |
QDEMod | IINPut | QINPut | AIQMag | TV
TRIGger:<measurement>[:SEQuence]:SOURce?
TRIGger[:SEQuence]:ATRigger <time>
TRIGger[:SEQuence]:ATRigger?
TRIGger[:SEQuence]:ATRigger:STATe OFF | ON | 0 | 1
TRIGger[:SEQuence]:ATRigger:STATe?
TRIGger[:SEQuence]:DELay <time>
TRIGger[:SEQuence]:DELay?
TRIGger[:SEQuence]:DELay:STATe OFF | ON | 0 | 1
TRIGger[:SEQuence]:DELay:STATe?
TRIGger[:SEQuence]:EXTernal2:DELay <time>
TRIGger[:SEQuence]:EXTernal:DELay
TRIGger[:SEQuence]:EXTernal1:DELay <time>
TRIGger[:SEQuence]:EXTernal2:DELay?
TRIGger[:SEQuence]:EXTernal1:DELay?
TRIGger[:SEQuence]:EXTernal2:DELay:COMPensation OFF | ON | 0 | 1
TRIGger[:SEQuence]:EXTernal1:DELay:COMPensation OFF | ON | 0 | 1
TRIGger[:SEQuence]:EXTernal1:DELay:COMPensation?
TRIGger[:SEQuence]:EXTernal2:DELay:COMPensation?
TRIGger[:SEQuence]:EXTernal1:DELay:STATe OFF | ON | 0 | 1
TRIGger[:SEQuence]:EXTernal2:DELay:STATe OFF | ON | 0 | 1
TRIGger[:SEQuence]:EXTernal1:DELay:STATe?
TRIGger[:SEQuence]:EXTernal2:DELay:STATe?
TRIGger[:SEQuence]:EXTernal:LEVel
TRIGger[:SEQuence]:EXTernal1:LEVel <level>
TRIGger[:SEQuence]:EXTernal2:LEVel
TRIGger[:SEQuence]:EXTernal1:LEVel?
TRIGger[:SEQuence]:EXTernal2:LEVel?
TRIGger[:SEQuence]:EXTernal:SLOPe
TRIGger[:SEQuence]:EXTernal2:SLOPe POSitive | NEGative
TRIGger[:SEQuence]:EXTernal1:SLOPe POSitive | NEGative
TRIGger[:SEQuence]:EXTernal1:SLOPe?
TRIGger[:SEQuence]:EXTernal2:SLOPe?
TRIGger[:SEQuence]:FRAME:EXTernal1:LEVel
TRIGger[:SEQuence]:FRAME:EXTernal2:LEVel
TRIGger[:SEQuence]:FRAME:EXTernal1:SLOPe
TRIGger[:SEQuence]:FRAME:EXTernal2:SLOPe
TRIGger[:SEQuence]:HOLDoff <time>
TRIGger[:SEQuence]:HOLDoff?
TRIGger[:SEQuence]:HOLDoff:STATe OFF | ON | 0 | 1
TRIGger[:SEQuence]:HOLDoff:STATe?
TRIGger[:SEQuence]:IF:LEVel
```



```

TRIGger[:SEQuence]:IF:LEVel?
TRIGger[:SEQuence]:IF:SLOPe NEGative | POSitive
TRIGger[:SEQuence]:IF:SLOPe?
TRIGger[:SEQuence]:OFFSet <time>
TRIGger[:SEQuence]:OFFSet?
TRIGger[:SEQuence]:OFFSet:STATe OFF | ON | 0 | 1
TRIGger[:SEQuence]:OFFSet:STATe?
TRIGger[:SEQuence]:SLOPe POSitive | NEGative
TRIGger[:SEQuence]:SLOPe?
TRIGger[:SEQuence]:SOURCe EXTernal
TRIGger[:SEQuence]:VIDeo:DELay <time>
TRIGger[:SEQuence]:VIDeo:DELay?
TRIGger[:SEQuence]:VIDeo:DELay:STATe OFF | ON | 0 | 1
TRIGger[:SEQuence]:VIDeo:DELay:STATe?
TRIGger[:SEQuence]:VIDeo:LEVel <ampl>
TRIGger[:SEQuence]:VIDeo:LEVel?
TRIGger[:SEQuence]:VIDeo:SLOPe POSitive | NEGative
TRIGger[:SEQuence]:VIDeo:SLOPe?
TRIGger|TRIGger1|TRIGger2[:SEQuence]:OUTPut HSWP | MEASuring | MAIN | GATE
| GTRigger | OEVEN | SPOint | SSweep | SSETtled | S1Marker | S2Marker |
S3Marker | S4Marker | OFF
TRIGger|TRIGger1|TRIGger2[:SEQuence]:OUTPut?
TRIGger|TRIGger1|TRIGger2[:SEQuence]:OUTPut:POLarity POSitive | NEGative
TRIGger|TRIGger1|TRIGger2[:SEQuence]:OUTPut:POLarity?
UNIT:APD:POWer
UNIT:APD:POWer?
UNIT:POWer DBM | DBMV | DBMA | V | W | A | DBUV | DBUA | DBPW | DBUVM |
DBUAM | DBPT | DBG
UNIT[1]|2:POWer DBUV | DBUV_MHZ | DBM | DBUA | DBUA_MHZ | DBPW | DBPW_MHZ
| DBPT | DBPT_MHZ | DBMV | DBMV_MHZ
UNIT:POWer?
UNIT[1]|2:POWer?

```

## STATus Subsystem

The following diagram provides a graphical overview of the entire X-Series Status Register System.

For readability, the diagram is split into two sections:

- ["X-Series Status Register System \(1\) " on page 99](#)
- ["X-Series Status Register System \(2\) " on page 100](#)

X-Series Status Register System (1)

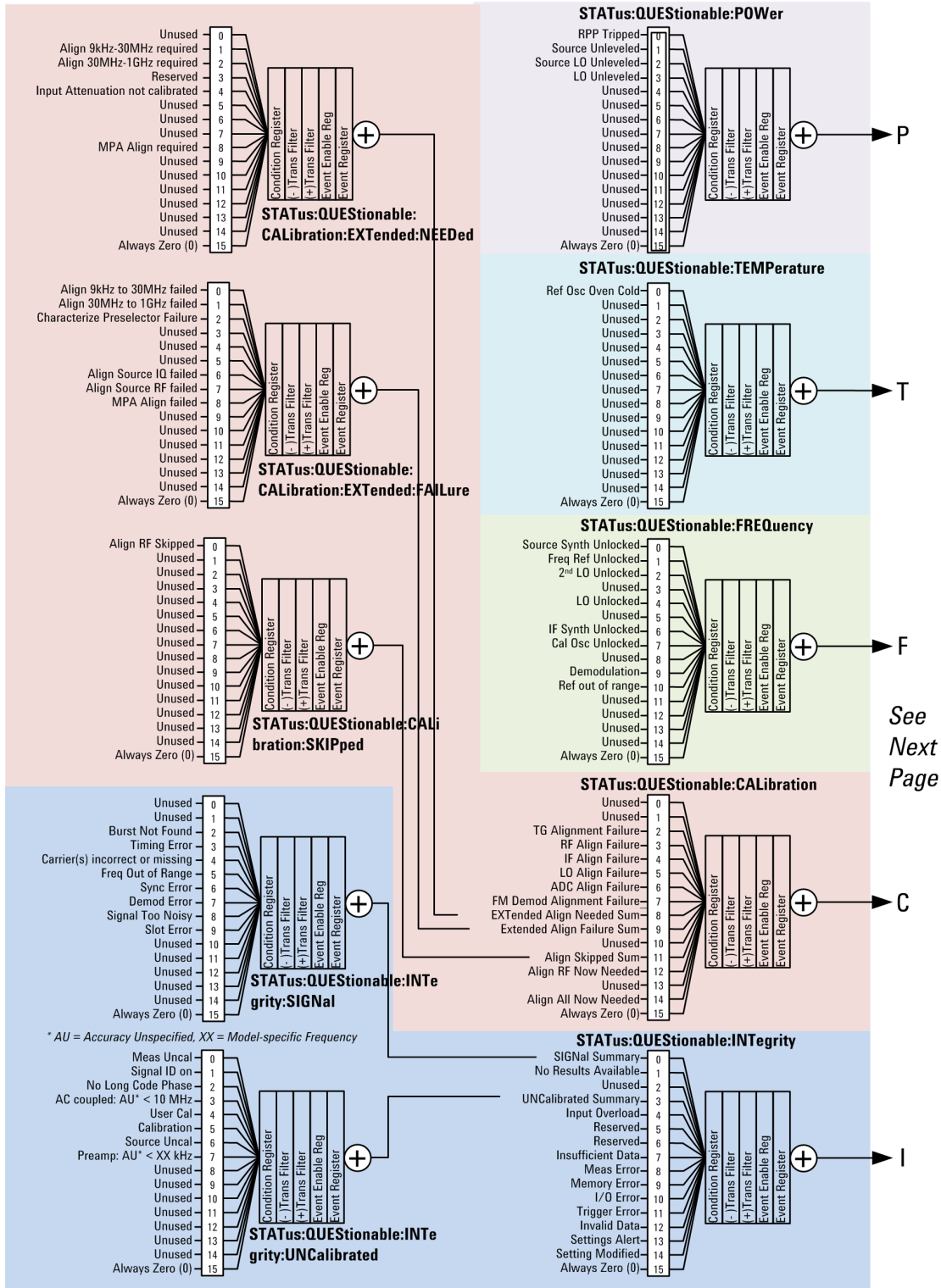

See  
Next  
Page

### X-Series Status Register System (2)

See  
 Previous  
 Page

P  
 T  
 F  
 C  
 I

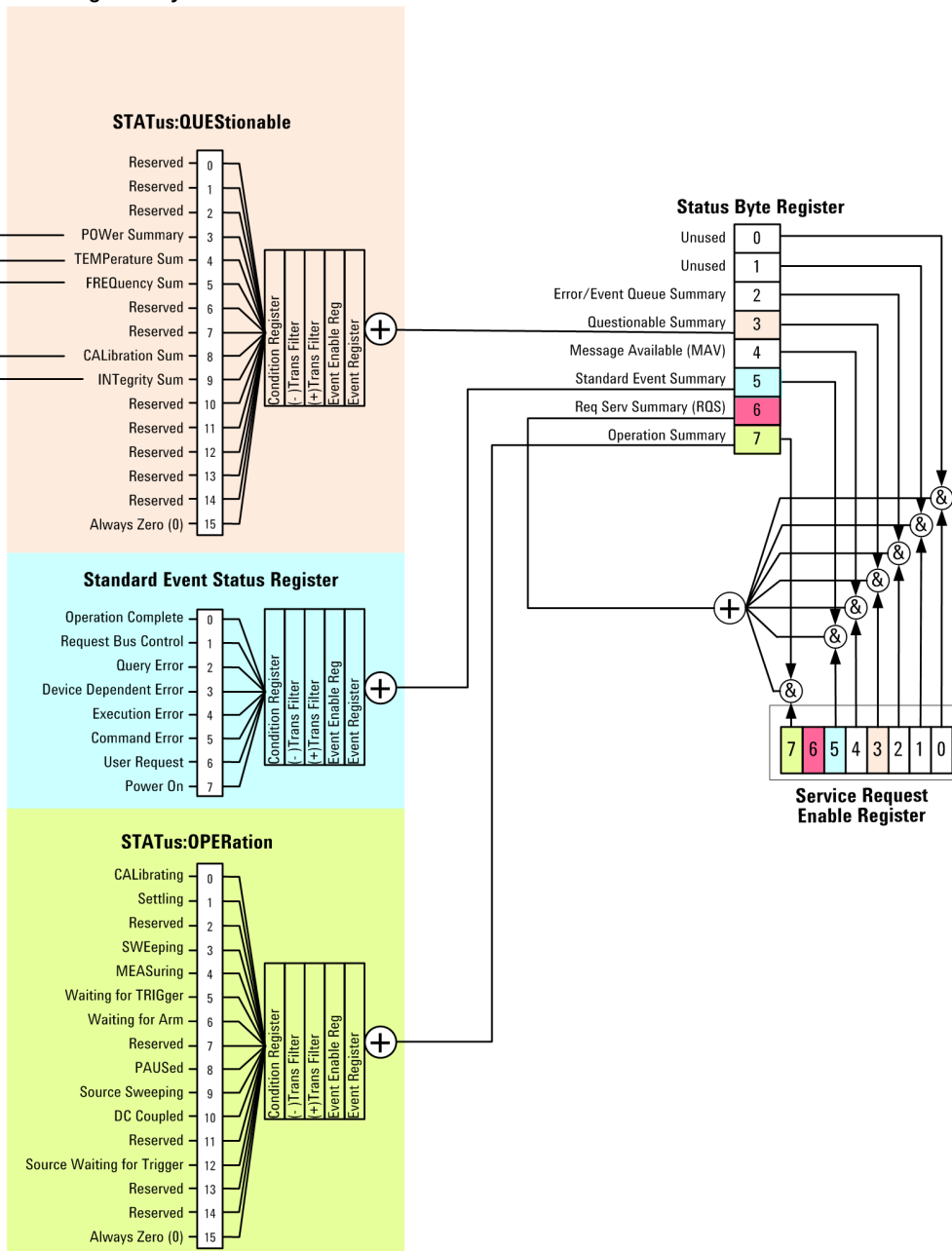

### Detailed Description

The STATus subsystem remote commands set and query the status hardware registers. This system of registers monitors various events and conditions in the instrument. Software written to control the instrument may need to monitor some of these events and conditions.

**NOTE**

All status register commands are sequential. Most commands can be started immediately and will overlap with any existing commands that are already running. This is not true of status commands. All the commands in the spectrum analyzer are assumed to be overlapped unless a command description specifically says that it is sequential.

## What Are Status Registers

The status system contains multiple registers that are arranged in a hierarchical order. The lower-level status registers propagate their data to the higher-level registers in the data structures by means of summary bits. The status byte register is at the top of the hierarchy and contains general status information for the instrument's events and conditions. All other individual registers are used to determine the specific events or conditions. For a diagram of the registers and their interconnections, see above.

The operation and questionable status registers are sets of registers that monitor the overall instrument condition. They are accessed with the STATus:OPERation and STATus:QUEStionable commands in the STATus command subsystem. Each register set is made up of five registers:

- Condition Register—It reports the real-time state of the signals monitored by this register set. There is no latching or buffering for a condition register.
- Positive Transition Register—This filter register controls which signals will set a bit in the event register when the signal makes a low to high transition (when the condition bit changes from 0 to 1).
- Negative Transition Register—This filter register controls which signals will set a bit in the event register when the signal makes a high to low transition (when the condition bit changes from 1 to 0).
- Event Register—It latches any signal state changes, in the way specified by the filter registers. Bits in the event register are never cleared by signal state changes. Event registers are cleared when read. They are also cleared by \*CLS and by presetting the instrument.
- Event Enable Register—It controls which of the bits, being set in the event register, will be summarized as a single output for the register set. Summary bits are then used by the next higher register.

The STATus:QUEStionable registers report abnormal operating conditions. The status register hierarchy is:

1. The summary outputs from the six STATus:QUEStionable:<keyword> detail registers are inputs to the STATus:QUEStionable register.
2. The summary output from the STATus:QUEStionable register is an input to the Status Byte Register. See the overall system in Figure at the beginning of this section.

The STATus:OPERation register set has no summarized inputs. The inputs to the STATus:OPERation:CONDition register indicate the real time state of the instrument. The STATus:OPERation:EVENT register summary output is an input to the Status Byte Register.

## What Are Status Register SCPI Commands

Most monitoring of the instrument conditions is done at the highest level using the IEEE common commands indicated below. Complete command descriptions are available in the IEEE commands section at the beginning of the language reference. Individual status registers can be set and queried using the commands in the STATus subsystem of the language reference.

- \*CLS (clear status) clears the status byte by emptying the error queue and clearing all the event registers.
- \*ESE, \*ESE? (event status enable) sets and queries the bits in the enable register part of the standard event status register.
- \*ESR? (event status register) queries and clears the event register part of the standard event status register.

- \*OPC, \*OPC? (operation complete) sets the standard event status register to monitor the completion of all commands. The query stops any new commands from being processed until the current processing is complete, then returns a '1'.
- \*PSC, \*PSC? (power-on state clear) sets the power-on state so that it clears the service request enable register and the event status enable register at power on.
- \*SRE, \*SRE? (service request enable) sets and queries the value of the service request enable register.
- \*STB? (status byte) queries the value of the status byte register without erasing its contents.

### How to Use the Status Registers

A program often needs to be able to detect and manage error conditions or changes in instrument status. There are two methods you can use to programmatically access the information in status registers:

- The polling method
- The service request (SRQ) method

In the polling method, the instrument has a passive role. It only tells the controller that conditions have changed when the controller asks the right question. In the SRQ method, the instrument takes a more active role. It tells the controller when there has been a condition change without the controller asking. Either method allows you to monitor one or more conditions.

The polling method works well if you do not need to know about changes the moment they occur. The SRQ method should be used if you must know immediately when a condition changes. To detect a change using the polling method, the program must repeatedly read the registers.

Use the SRQ method when:

- you need time-critical notification of changes
- you are monitoring more than one device which supports SRQs
- you need to have the controller do something else while waiting
- you can't afford the performance penalty inherent to polling

Use polling when:

- your programming language/development environment does not support SRQ interrupts
- you want to write a simple, single-purpose program and don't want the added complexity of setting up an SRQ handler
- To monitor a condition:
  - a. Determine which register contains the bit that reports the condition.
  - b. Send the unique SCPI query that reads that register.
  - c. Examine the bit to see if the condition has changed.

You can monitor conditions in different ways.

- Check the current instrument hardware and firmware status.

Do this by querying the condition registers which continuously monitor status. These registers represent the current state of the instrument. Bits in a condition register are updated in real time. When the condition monitored by a particular bit becomes true, the bit is set to 1. When the condition becomes false, the bit is reset to 0.

- Monitor a particular condition (bit).

You can enable a particular bit(s), using the event enable register. The instrument will then monitor that particular condition(s). If the bit becomes true (0 to 1 transition) in the event register, it will stay set until the event register is cleared. Querying the event register allows you to detect that this condition occurred even if the condition no longer exists. The event register can only be cleared by querying it or sending the \*CLS command.

- Monitor a particular type of change in a condition (bit).
  - The transition registers are preset to register if the condition goes from 0 to 1 (false to true, or a positive transition).
  - This can be changed so the selected condition is detected if the bit goes from 1 to 0 (true to false, or a negative transition).
  - It can also be set for both types of transitions occurring.
  - Or it can be set for neither transition. If both transition registers are set to 0 for a particular bit position, that bit will not be set in the event register for either type of change.

### Using a Status Register

Each bit in a register is represented by a numerical value based on its location. See figure below. This number is sent with the command to enable a particular bit. If you want to enable more than one bit, you would send the sum of all the bits that you want to monitor.

Figure: Status Register Bit Values

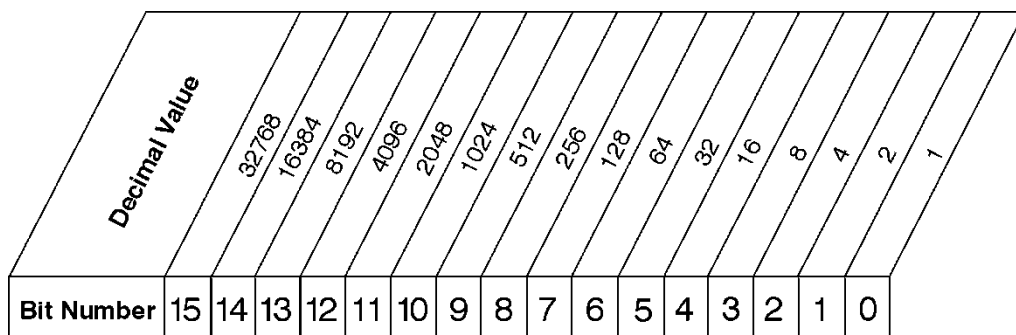

STATus:OPERation:ENABLE <num>  
 STATus:OPERation:ENABLE?

### Standard Operation Event Enable Register

ck730a

Bit 15 is not used to report status.

Example 1:

1. To enable bit 0 and bit 6 of standard event status register, you would send the command \*ESE 65 because 1 + 64 = 65.

2. The results of a query are evaluated in a similar way. If the \*STB? command returns a decimal value of 140, ( $140 = 128 + 8 + 4$ ) then bit 7 is true, bit 3 is true and bit 2 is true.

Example 2:

1. Suppose you want to know if an Auto-trigger Timeout occurs, but you only cared about that specific condition. So you would want to know what was happening with bit 10 in the Status Questionable Integrity register, and not about any other bits.
2. It's usually a good idea to start by clearing all the status registers with \*CLS.
3. Sending the STAT:QUES:INT:ENAB 1024 command lets you monitor only bit 10 events, instead of the default monitoring all the bits in the register. The register default is for positive transition events (0 to 1 transition). That is, when an auto-trigger timeout occurs. If instead, you wanted to know when the Auto-trigger timeout condition is cleared, then you would set the STAT:QUES:INT:PTR 0 and the STAT:QUES:INT:NTR 32767.
4. So now the only output from the Status Questionable Integrity register will come from a bit 10 positive transition. That output goes to the Integrity Sum bit 9 of the Status Questionable register.
5. You can do a similar thing with this register to only look at bit 9 using, STAT:QUES:ENAB 512.
6. The Status Questionable register output goes to the "Status Questionable Summary" bit 3 of the Status Byte Register. The output from this register can be enabled using the \*SRE 8 command.
7. Finally, you would use the serial polling functionality available for the particular bus/software that you are using to monitor the Status Byte Register. (You could also use \*STB? to poll the Status Byte Register.)

### Using the Service Request (SRQ) Method

Your language, bus, and programming environment must be able to support SRQ interrupts. (For example, BASIC used with VXI-11.3 (GPIB over LAN). When you monitor a condition with the SRQ method, you must:

1. Determine which bit monitors the condition.
2. Determine how that bit reports to the request service (RQS) bit of the status byte.
3. Send SCPI commands to enable the bit that monitors the condition and to enable the summary bits that report the condition to the RQS bit.
4. Enable the controller to respond to service requests.

When the condition changes, the instrument sets its RQS bit. The controller is informed of the change as soon as it occurs. As a result, the time the controller would otherwise have used to monitor the condition can be used to perform other tasks. Your program determines how the controller responds to the SRQ.

### Generating a Service Request

To use the SRQ method, you must understand how service requests are generated. Bit 6 of the status byte register is the request service (RQS) bit. The \*SRE command is used to configure the RQS bit to report changes in instrument status. When such a change occurs, the RQS bit is set. It is cleared when the status byte register is queried using \*SRE? (with a serial poll.) It can be queried without erasing the contents with \*STB?.



When a register set causes a summary bit in the status byte to change from 0 to 1, the instrument can initiate the service request (SRQ) process. However, the process is only initiated if both of the following conditions are true:

- The corresponding bit of the service request enable register is also set to 1.
- The instrument does not have a service request pending. (A service request is considered to be pending between the time the instrument's SRQ process is initiated and the time the controller reads the status byte register.)

The SRQ process sets the SRQ true. It also sets the status byte's request service (RQS) bit to 1. Both actions are necessary to inform the controller that the instrument requires service. Setting the SRQ line only informs the controller that some device on the bus requires service. Setting the RQS bit allows the controller to determine which instrument requires service.

If your program enables the controller to detect and respond to service requests, it should instruct the controller to perform a serial poll when the SRQ is set true. Each device on the bus returns the contents of its status byte register in response to this poll. The device who's RQS bit is set to 1 is the device that requested service.

When you read the instrument's status byte register with a serial poll, the RQS bit is reset to 0. Other bits in the register are not affected.

If the status register is configured to SRQ on end-of-measurement and the measurement is in continuous mode, then restarting a measurement (INIT command) can cause the measuring bit to pulse low. This causes an SRQ when you have not actually reached the "end-of-measurement" condition. To avoid this:

1. Set INITiate:CONTinuous off.
2. Set/enable the status registers.
3. Restart the measurement (send INIT).

## Status Register System

The hardware status registers are combined to form the instrument status system. Specific status bits are assigned to monitor various aspects of the instrument operation and status. See the diagram of the status system above for information about the bit assignments and status register interconnections.

### The Status Byte Register

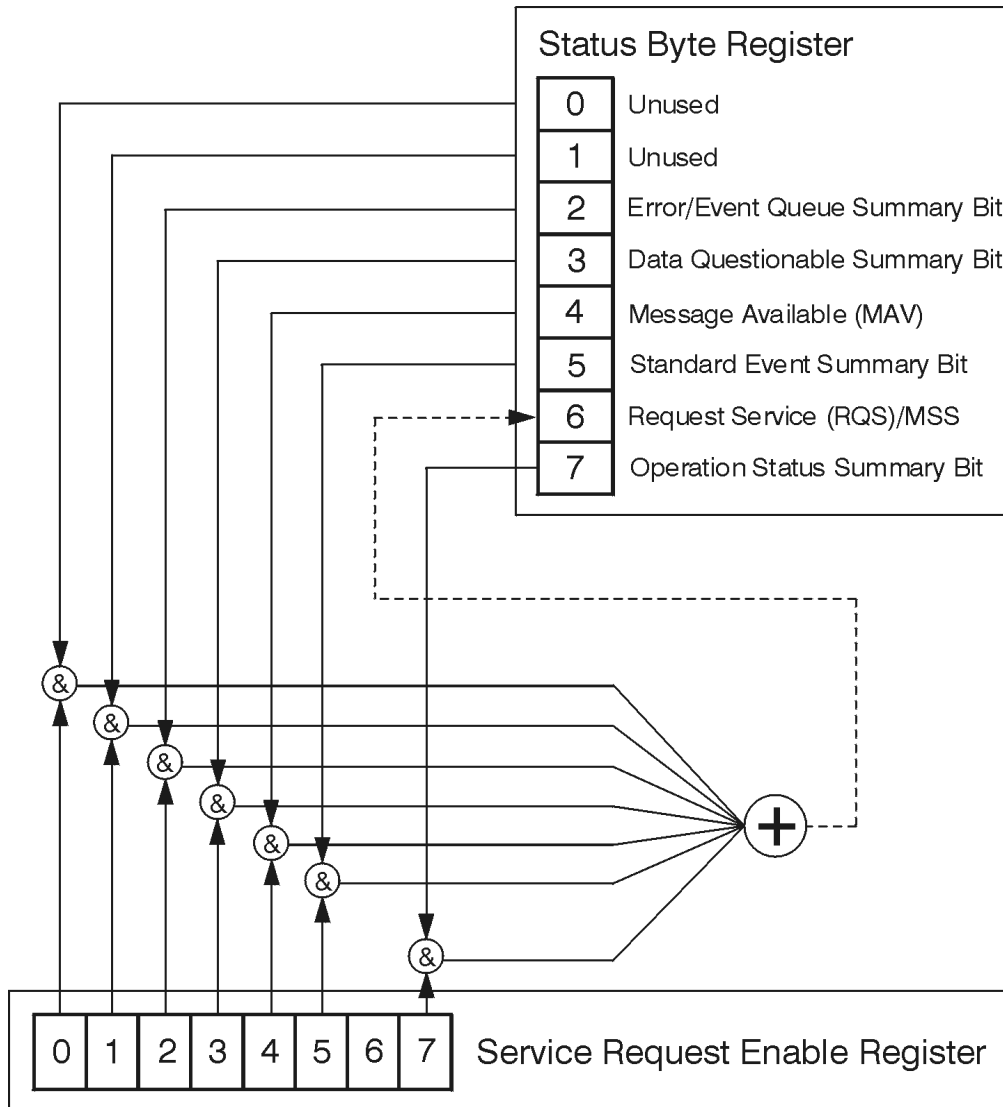

ck776a

The RQS bit is read and reset by a serial poll. The same bit position (MSS) is read, non-destructively by the \*STB? command. If you serial poll bit 6 it is read as RQS, but if you send \*STB it reads bit 6 as MSS. For more information refer to IEEE 488.2 standards, section 11.

	<b>Description</b>								
	Standard Operation Status Summary Bit	Request Service (RQS) Summary Bit	Standard Event Status Summary Bit	Message Available (MAV)	Data Questionable Status Summary Bit	Error/Event Queue Summary Bit	Unused	Unused	
<b>Bit Number</b>	7	6	5	4	3	2	1	0	

\*STB?

**Status Byte Register**

ck725a

Bit	Description
0, 1	These bits are always set to 0.
2	A 1 in this bit position indicates that the SCPI error queue is not empty which means that it contains at least one error message.
3	A 1 in this bit position indicates that the data questionable summary bit has been set. The data questionable event register can then be read to determine the specific condition that caused this bit to be set.
4	A 1 in this bit position indicates that the instrument has data ready in the output queue. There are no lower status groups that provide input to this bit.
5	A 1 in this bit position indicates that the standard event summary bit has been set. The standard event status register can then be read to determine the specific event that caused this bit to be set.
6	A 1 in this bit position indicates that the instrument has at least one reason to report a status change. This bit is also called the master summary status bit (MSS).
7	A 1 in this bit position indicates that the standard operation summary bit has been set. The standard operation event register can then be read to determine the specific condition that caused this bit to be set.

To query the status byte register, send the command \*STB?. The response will be the decimal sum of the bits which are set to 1. For example, if bit number 7 and bit number 3 are set to 1, the decimal sum of the 2 bits is 128 plus 8. So the decimal value 136 is returned. The \*STB command does not clear the status register.

In addition to the status byte register, the status byte group also contains the service request enable register. This register lets you choose which bits in the status byte register will trigger a service request.

Send the \*SRE <integer> command where <integer> is the sum of the decimal values of the bits you want to enable plus the decimal value of bit 6. For example, assume that you want to enable bit 7 so that whenever the standard operation status register summary bit is set to 1 it will trigger a service request. Send the command \*SRE 192 (because 192 = 128 + 64). You must always add 64 (the numeric value of RQS

bit 6) to your numeric sum when you enable any bits for a service request. The command \*SRE? returns the decimal value of the sum of the bits previously enabled with the \*SRE <integer> command.

The service request enable register presets to zeros (0).

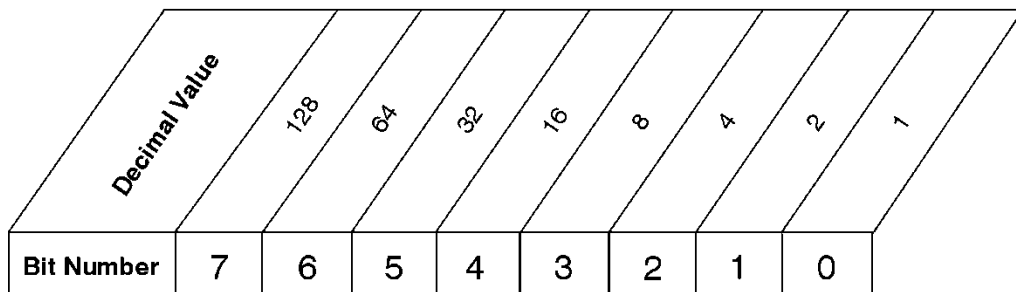

\*SRE <num>  
 \*SRE?

**Service Request Enable Register**

ck726a

**Standard Event Status Register**

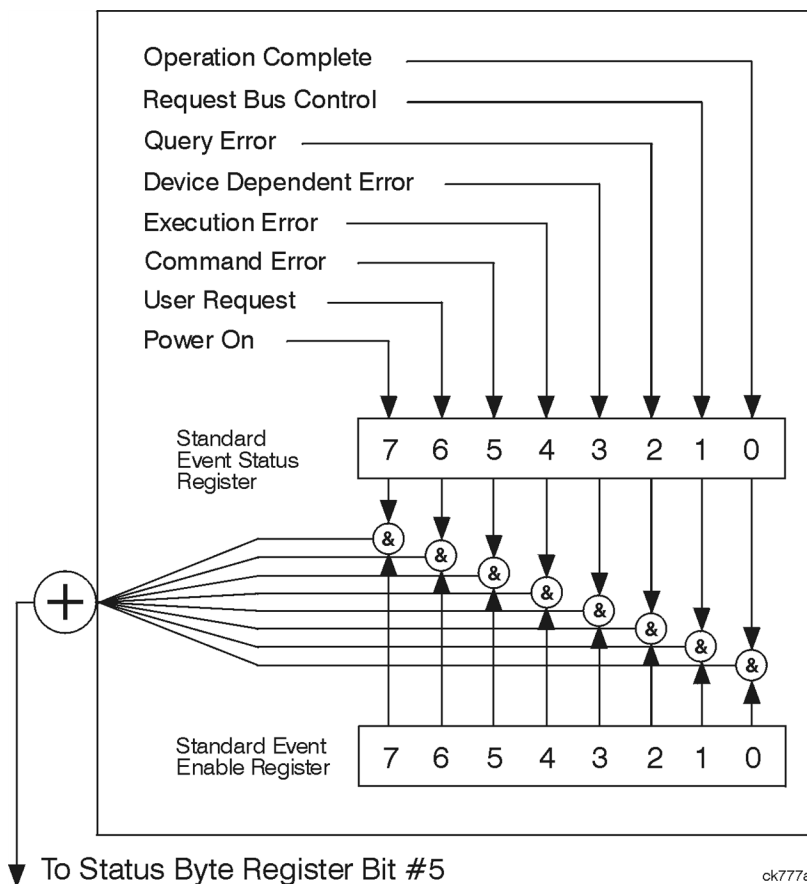

ck777a

The standard event status register contains the following bits:

<b>Description</b>									
	Power On	User Request Key (Local)	Command Error	Execution Error	Device Dependent Error	Query Error	Request Control	Operation Complete	
<b>Bit Number</b>	7	6	5	4	3	2	1	0	

\*ESR?

### Standard Event Status Register

ck727a

Bit	Description
0	A 1 in this bit position indicates that all pending operations were completed following execution of the *OPC command.
1	This bit is for GPIB handshaking to request control. Currently it is set to 0 because there are no implementations where the spectrum analyzer controls another instrument.
2	A 1 in this bit position indicates that a query error has occurred. Query errors have SCPI error numbers from -499 to -400.
3	A 1 in this bit position indicates that a device dependent error has occurred. Device dependent errors have SCPI error numbers from -399 to -300 and 1 to 32767.
4	A 1 in this bit position indicates that an execution error has occurred. Execution errors have SCPI error numbers from -299 to -200.
5	A 1 in this bit position indicates that a command error has occurred. Command errors have SCPI error numbers from -199 to -100.
6	A 1 in this bit position indicates that the LOCAL key has been pressed. This is true even if the instrument is in local lockout mode.
7	A 1 in this bit position indicates that the instrument has been turned off and then on.

The standard event status register is used to determine the specific event that set bit 5 in the status byte register. To query the standard event status register, send the command \*ESR?. The response will be the decimal sum of the bits which are enabled (set to 1). For example, if bit number 7 and bit number 3 are enabled, the decimal sum of the 2 bits is 128 plus 8. So the decimal value 136 is returned.

In addition to the standard event status register, the standard event status group also contains a standard event status enable register. This register lets you choose which bits in the standard event status register will set the summary bit (bit 5 of the status byte register) to 1. Send the \*ESE <integer> command where <integer> is the sum of the decimal values of the bits you want to enable. For example, to enable bit 7 and bit 6 so that whenever either of those bits is set to 1, the standard event status summary bit of the status

byte register will be set to 1, send the command \*ESE 192 (128 + 64). The command \*ESE? returns the decimal value of the sum of the bits previously enabled with the \*ESE <integer> command.

The standard event status enable register presets to zeros (0).

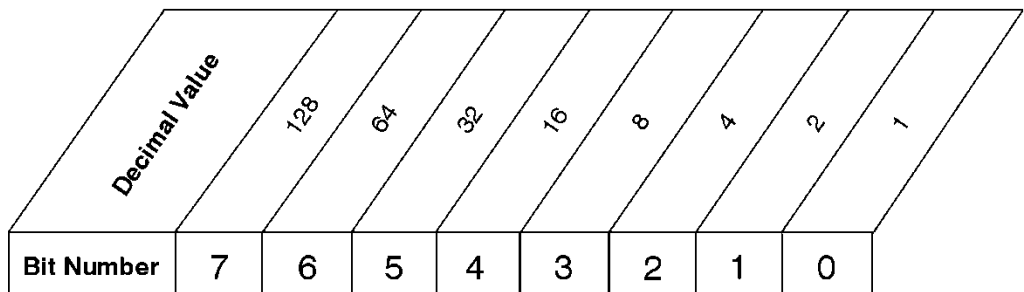

\*ESE <num>  
 \*ESE?

### Standard Event Status Enable Register

ck728a

### Operation and Questionable Status Registers

The operation and questionable status registers are registers that monitor the overall instrument condition. They are accessed with the STATus:OPERation and STATus:QUEStionable commands in the STATus command subsystem. See the figure at the beginning of this chapter.

#### Operation Status Register

The operation status register monitors the current instrument measurement state. It checks to see if the instrument is calibrating, sweeping, or waiting for a trigger. For more information see the \*OPC? command located in the IEEE Common Commands section.

Bit	Condition	Operation
0	Calibrating	The instrument is busy executing its Align Now process
3	Sweeping	The instrument is busy taking a sweep.
4	Measuring	The instrument is busy making a measurement. Measurements often require multiple sweeps. They are initiated by keys under the MEASURE key or with the MEASure group of commands. The bit is valid for most X-Series Modes.
5	Waiting for trigger	The instrument is waiting for the trigger conditions to be met, then it will trigger a sweep or measurement.

#### Questionable Status Register

The questionable status register monitors the instrument's condition to see if anything questionable has happened to it. It is looking for anything that might cause an error or a bad measurement like a hardware problem, an out of calibration situation, or a unusual signal. All the bits are summary bits from lower-level event registers.

Bit	Condition	Operation
-----	-----------	-----------

3	Power summary	The instrument hardware has detected a power unlevelled condition.
4	Temperature summary	The instrument is still warming up.
5	Frequency summary	The instrument hardware has detected an unlocked condition or a problem with the external frequency reference.
8	Calibration summary	The instrument has detected a hardware problem while doing the automatic internal alignment process.
9	Integrity summary	The instrument has detected a questionable measurement condition such as: bad timing, bad signal/data, timeout problem, signal overload, or "meas uncal".

## STATus Subsystem Command Descriptions

The STATus subsystem controls the SCPI-defined instrument status reporting structures. Each status register has a set of five commands used for querying or masking that particular register.

Numeric values for bit patterns can be entered using decimal or hexadecimal representations. (i.e. 0 to 32767 is equivalent to #H0 to #H7FFF. It is also equal to all ones, 111111111111111) See the SCPI Basics information about using bit patterns for variable parameters.

### Operation Register

"Operation Condition Query" on page 111

"Operation Enable" on page 112

"Operation Event Query" on page 112

"Operation Negative Transition" on page 112

"Operation Positive Transition" on page 113

### Operation Condition Query

This query returns the decimal value of the sum of the bits in the Status Operation Condition register.

**NOTE** The data in this register is continuously updated and reflects the current conditions.

Mode	All
<b>Remote Command</b>	:STATus:OPERation:CONDition?
<b>Example</b>	STAT:OPER:COND?
Preset	0
Status Bits/OPC dependencies	Sequential command
Initial S/W Revision	Prior to A.02.00

### Operation Enable

This command determines which bits in the Operation Event register, will set the Operation Status Summary bit (bit 7) in the Status Byte Register. The variable <integer> is the sum of the decimal values of the bits you want to enable.

**NOTE** The preset condition is to have all bits in this enable register set to 0. To have any Operation Events reported to the Status Byte Register, one or more bits need to be set to 1.

Mode	All
<b>Remote Command</b>	:STATus:OPERation:ENABle <integer> :STATus:OPERation:ENABle?
<b>Example</b>	STAT:OPER:ENAB 1 Sets the register so that Align Now operation will be reported to the Status Byte Register.
Preset	0
Min	0
Max	32767
Status Bits/OPC dependencies	Sequential command
Initial S/W Revision	Prior to A.02.00

### Operation Event Query

This query returns the decimal value of the sum of the bits in the Operation Event register.

**NOTE** The register requires that the associated PTR or NTR filters be set before a condition register bit can set a bit in the event register. The data in this register is latched until it is queried. Once queried, the register is cleared.

Mode	All
<b>Remote Command</b>	:STATus:OPERation[:EVENT]?
<b>Example</b>	STAT:OPER?
Preset	0
Status Bits/OPC dependencies	Sequential command
Initial S/W Revision	Prior to A.02.00

### Operation Negative Transition

This command determines which bits in the Operation Condition register will set the corresponding bit in the Operation Event register when the condition register bit has a negative transition (1 to 0). The variable <integer> is the sum of the decimal values of the bits that you want to enable.



Mode	All
<b>Remote Command</b>	:STATus:OPERation:NTRansition <integer> :STATus:OPERation:NTRansition?
<b>Example</b>	STAT:OPER:NTR 1 Align Now operation complete will be reported to the Status Byte Register.
Preset	0
Min	0
Max	32767
Status Bits/OPC dependencies	Sequential command
Initial S/W Revision	Prior to A.02.00

### Operation Positive Transition

This command determines which bits in the Operation Condition register will set the corresponding bit in the Operation Event register when the condition register bit has a positive transition (0 to 1). The variable <integer> is the sum of the decimal values of the bits that you want to enable.

Mode	All
<b>Remote Command</b>	:STATus:OPERation:PTRansition <integer> :STATus:OPERation:PTRansition?
<b>Example</b>	STAT:OPER:PTR 1 Align Now operation beginning will be reported to the Status Byte Register.
Preset	32767
Min	0
Max	32767
Status Bits/OPC dependencies	Sequential command
Initial S/W Revision	Prior to A.02.00

### Preset the Status Byte

Sets bits in most of the enable and transition registers to their default state. It presets all the Transition Filters, Enable Registers, and the Error/Event Queue Enable. It has no effect on Event Registers, Error/Event QUEUE, IEEE 488.2 ESE, and SRE Registers as described in IEEE Standard 488.2–1992, IEEE Standard Codes, Formats, Protocols, and Common Commands for Use with ANSI/IEEE Std 488.1–1987. New York, NY, 1992.

<b>Remote Command</b>	:STATus:PRESet
<b>Example</b>	STAT:PREs
Initial S/W Revision	Prior to A.02.00

## Questionable Register

"Questionable Condition " on page 114

"Questionable Enable " on page 114

"Questionable Event Query " on page 115

"Questionable Negative Transition " on page 115

"Questionable Positive Transition" on page 115

### Questionable Condition

This query returns the decimal value of the sum of the bits in the Questionable Condition register.

**NOTE** The data in this register is continuously updated and reflects the current conditions.

Mode	All
<b>Remote Command</b>	:STATus:QUEStionable:CONDition?
<b>Example</b>	STAT:QUES:COND?
Preset	0
Status Bits/OPC dependencies	Sequential command
Initial S/W Revision	Prior to A.02.00

### Questionable Enable

This command determines which bits in the Questionable Event register will set the Questionable Status Summary bit (bit3) in the Status Byte Register. The variable <integer> is the sum of the decimal values of the bits you want to enable.

**NOTE** The preset condition is all bits in this enable register set to 0. To have any Questionable Events reported to the Status Byte Register, one or more bits need to be set to 1. The Status Byte Event Register should be queried after each measurement to check the Questionable Status Summary (bit 3). If it is equal to 1, a condition during the test may have made the test results invalid. If it is equal to 0, this indicates that no hardware problem or measurement problem was detected by the analyzer.

Mode	All
<b>Remote Command</b>	:STATus:QUEStionable:ENABle <integer> :STATus:QUEStionable:ENABle?
<b>Example</b>	STAT:OPER:PTR 1 Align Now operation beginning will be reported to the Status Byte Register.
Preset	0
Min	0
Max	32767
Status Bits/OPC dependencies	Sequential command
Initial S/W Revision	Prior to A.02.00

## Questionable Event Query

This query returns the decimal value of the sum of the bits in the Questionable Event register.

**NOTE**

The register requires that the associated PTR or NTR filters be set before a condition register bit can set a bit in the event register. The data in this register is latched until it is queried. Once queried, the register is cleared.

Mode	All
<b>Remote Command</b>	:STATus:QUEStionable[:EVENT]?
<b>Example</b>	STAT:QUES?
Preset	0
Status Bits/OPC dependencies	Sequential command
Initial S/W Revision	Prior to A.02.00

## Questionable Negative Transition

This command determines which bits in the Questionable Condition register will set the corresponding bit in the Questionable Event register when the condition register bit has a negative transition (1 to 0). The variable <integer> is the sum of the decimal values of the bits that you want to enable.

Mode	All
<b>Remote Command</b>	:STATus:QUEStionable:NTRansition <integer> :STATus:QUEStionable:NTRansition?
<b>Example</b>	STAT:QUES:NTR 16 Temperature summary 'questionable cleared' will be reported to the Status Byte Register.
Preset	0
Min	0
Max	32767
Status Bits/OPC dependencies	Sequential command
Initial S/W Revision	Prior to A.02.00

## Questionable Positive Transition

This command determines which bits in the Questionable Condition register will set the corresponding bit in the Questionable Event register when the condition register bit has a positive transition (0 to 1). The variable <integer> is the sum of the decimal values of the bits that you want to enable.

Mode	All
------	-----

<b>Remote Command</b>	:STATus:QUEStionable:PTRansition <integer> :STATus:QUEStionable:PTRansition?
<b>Example</b>	STAT:QUES:PTR 16 Temperature summary 'questionable asserted' will be reported to the Status Byte Register.
Preset	32767
Min	0
Max	32767
Status Bits/OPC dependencies	Sequential command
Initial S/W Revision	Prior to A.02.00

### Questionable Calibration Register

"Questionable Calibration Condition " on page 116

"Questionable Calibration Enable " on page 116

"Questionable Calibration Event Query " on page 117

"Questionable Calibration Negative Transition " on page 117

"Questionable Calibration Positive Transition " on page 118

### Questionable Calibration Condition

This query returns the decimal value of the sum of the bits in the Questionable Calibration Condition register.

**NOTE**

The data in this register is continuously updated and reflects the current conditions.

Mode	All
<b>Remote Command</b>	:STATus:QUEStionable:CALibration:CONDition?
<b>Example</b>	STAT:QUES:CAL:COND?
Preset	0
Status Bits/OPC dependencies	Sequential command
Initial S/W Revision	Prior to A.02.00

### Questionable Calibration Enable

This command determines which bits in the Questionable Calibration Condition Register will set bits in the Questionable Calibration Event register, which also sets the Calibration Summary bit (bit 8) in the Questionable Register. The variable <integer> is the sum of the decimal values of the bits you want to enable.

Mode	All
<b>Remote Command</b>	:STATus:QUESTionable:CALibration:ENABle <integer> :STATus:QUESTionable:CALibration:ENABle?
<b>Example</b>	STAT:QUES:CAL:ENAB 16384 Can be used to query if an alignment is needed, if you have turned off the automatic alignment process.
Min	0
Max	32767
Status Bits/OPC dependencies	Sequential command
Initial S/W Revision	Prior to A.02.00

### Questionable Calibration Event Query

This query returns the decimal value of the sum of the bits in the Questionable Calibration Event register.

**NOTE**

The register requires that the associated PTR or NTR filters be set before a condition register bit can set a bit in the event register. The data in this register is latched until it is queried. Once queried, the register is cleared.

Mode	All
<b>Remote Command</b>	:STATus:QUESTionable:CALibration[:EVENT]?
<b>Example</b>	STAT:QUES:CAL?
Preset	0
Status Bits/OPC dependencies	Sequential command
Initial S/W Revision	Prior to A.02.00

### Questionable Calibration Negative Transition

This command determines which bits in the Questionable Calibration Condition register will set the corresponding bit in the Questionable Calibration Event register when the condition register bit has a negative transition (1 to 0). The variable <integer> is the sum of the decimal values of the bits that you want to enable.

Mode	All
<b>Remote Command</b>	:STATus:QUESTionable:CALibration:NTRansition <integer> :STATus:QUESTionable:CALibration:NTRansition?
<b>Example</b>	STAT:QUES:CAL:NTR 16384 Alignment is not required.
Preset	0
Min	0

Max	32767
Status Bits/OPC dependencies	Sequential command
Initial S/W Revision	Prior to A.02.00

### Questionable Calibration Positive Transition

This command determines which bits in the Questionable Calibration Condition register will set the corresponding bit in the Questionable Calibration Event register when the condition register bit has a positive transition (0 to 1). The variable <integer> is the sum of the decimal values of the bits that you want to enable.

Mode	All
<b>Remote Command</b>	:STATus:QUESTionable:CALibration:PTRansition <integer> :STATus:QUESTionable:CALibration:PTRansition?
<b>Example</b>	STAT:QUES:CAL:PTR 16384 Alignment is required.
Preset	32767
Min	0
Max	32767
Status Bits/OPC dependencies	Sequential command
Initial S/W Revision	Prior to A.02.00

### Questionable Calibration Skipped Register

- "Questionable Calibration Skipped Condition " on page 118
- "Questionable Calibration Skipped Enable " on page 119
- "Questionable Calibration Skipped Event Query " on page 119
- "Questionable Calibration Skipped Negative Transition " on page 120
- "Questionable Calibration Skipped Positive Transition " on page 120

### Questionable Calibration Skipped Condition

This query returns the decimal value of the sum of the bits in the Questionable Calibration Skipped Condition register.

**NOTE** The data in this register is continuously updated and reflects the current conditions.

Mode	All
<b>Remote Command</b>	:STATus:QUESTionable:CALibration:SKIpped:CONDition?

<b>Example</b>	STAT:QUES:CAL:SKIP:COND?
Preset	0
Status Bits/OPC dependencies	Sequential command
Initial S/W Revision	Prior to A.02.00

### Questionable Calibration Skipped Enable

This command determines which bits in the Questionable Calibration Skipped Condition Register will set bits in the Questionable Calibration Skipped Event register, which also sets bit 11 of the Questionable Calibration Register. The variable <integer> is the sum of the decimal values of the bits you want to enable.

Mode	All
<b>Remote Command</b>	:STATus:QUESTionable:CALibration:SKIPped:ENABle <integer> :STATus:QUESTionable:CALibration:SKIPped:ENABle?
<b>Example</b>	STAT:QUES:CAL:SKIP:ENAB 1 Can be used to query if an EMI alignment skipped condition is detected
Preset	32767
Min	0
Max	32767
Status Bits/OPC dependencies	Sequential command
Initial S/W Revision	Prior to A.02.00

### Questionable Calibration Skipped Event Query

This query returns the decimal value of the sum of the bits in the Questionable Calibration Event register.

**NOTE** The register requires that the associated PTR or NTR filters be set before a condition register bit can set a bit in the event register. The data in this register is latched until it is queried. Once queried, the register is cleared.

Mode	All
<b>Remote Command</b>	:STATus:QUESTionable:CALibration:SKIPped[:EVENT]?
<b>Example</b>	STAT:QUES:CAL:SKIP?
Preset	0
Status Bits/OPC dependencies	Sequential command
Initial S/W Revision	Prior to A.02.00

### Questionable Calibration Skipped Negative Transition

This command determines which bits in the Questionable Calibration Skipped Condition register will set the corresponding bit in the Questionable Calibration Skipped Event register when the condition register bit has a negative transition (1 to 0). The variable <integer> is the sum of the decimal values of the bits that you want to enable.

Mode	All
<b>Remote Command</b>	:STATus:QUEStionable:CALibration:SKIpped:NTRansition <integer> :STATus:QUEStionable:CALibration:SKIpped:NTRansition?
<b>Example</b>	STAT:QUES:CAL:SKIP:NTR 1 Align RF skipped is not required.
Preset	0
Min	0
Max	32767
Status Bits/OPC dependencies	Sequential command
Initial S/W Revision	Prior to A.02.00

### Questionable Calibration Skipped Positive Transition

This command determines which bits in the Questionable Calibration Skipped Condition register will set the corresponding bit in the Questionable Calibration Skipped Event register when the condition register bit has a positive transition (0 to 1). The variable <integer> is the sum of the decimal values of the bits that you want to enable.

Mode	All
<b>Remote Command</b>	:STATus:QUEStionable:CALibration:SKIpped:PTRansition <integer> :STATus:QUEStionable:CALibration:SKIpped:PTRansition?
<b>Example</b>	STAT:QUES:CAL:SKIP:PTR 1 Align RF skipped is required.
Preset	32767
Min	0
Max	32767
Status Bits/OPC dependencies	Sequential command
Initial S/W Revision	Prior to A.02.00

### Questionable Calibration Extended Failure Register

"Questionable Calibration Extended Failure Condition " on page 121

"Questionable Calibration Extended Failure Enable " on page 121

"Questionable Calibration Extended Failure Event Query " on page 121

"Questionable Calibration Extended Failure Negative Transition " on page 122



"Questionable Calibration Extended Failure Positive Transition " on page 122

### Questionable Calibration Extended Failure Condition

This query returns the decimal value of the sum of the bits in the Questionable Calibration Extended Failure Condition register.

**NOTE** The data in this register is continuously updated and reflects the current conditions.

Mode	All
<b>Remote Command</b>	:STATus:QUEStionable:CALibration:EXTended:FAILure:CONDition?
<b>Example</b>	STAT:QUES:CAL:EXT:FAIL:COND?
Preset	0
Status Bits/OPC dependencies	Sequential command
Initial S/W Revision	Prior to A.02.00

### Questionable Calibration Extended Failure Enable

This command determines which bits in the Questionable Calibration Extended Failure Condition Register will set bits in the Questionable Calibration Extended Failure Event register, which also sets bit 9 of the Questionable Calibration Register. The variable <integer> is the sum of the decimal values of the bits you want to enable.

Mode	All
<b>Remote Command</b>	:STATus:QUEStionable:CALibration:EXTended:FAILure:ENABle <integer> :STATus:QUEStionable:CALibration:EXTended:FAILure:ENABle?
<b>Example</b>	STAT:QUES:CAL:EXT:FAIL:ENAB 1 Can be used to query if an EMI conducted alignment is needed.
Preset	32767
Min	0
Max	32767
Status Bits/OPC dependencies	Sequential command
Initial S/W Revision	Prior to A.02.00

### Questionable Calibration Extended Failure Event Query

This query returns the decimal value of the sum of the bits in the Questionable Calibration Extended Failure Event register.

**NOTE** The register requires that the associated PTR or NTR filters be set before a condition register bit can set a bit in the event register. The data in this register is latched until it is queried. Once queried, the register is cleared.

Mode	All
<b>Remote Command</b>	:STATus:QUESTionable:CALibration:EXTended:FAILure[:EVENT]?
<b>Example</b>	STAT:QUES:CAL:EXT:FAIL?
Preset	0
Status Bits/OPC dependencies	Sequential command
Initial S/W Revision	Prior to A.02.00

### Questionable Calibration Extended Failure Negative Transition

This command determines which bits in the Questionable Calibration Extended Failure Condition register will set the corresponding bit in the Questionable Calibration Extended Failure Event register when the condition register bit has a negative transition (1 to 0). The variable <integer> is the sum of the decimal values of the bits that you want to enable.

Mode	All
<b>Remote Command</b>	:STATus:QUESTionable:CALibration:EXTended:FAILure:NTRansition <integer> :STATus:QUESTionable:CALibration:EXTended:FAILure:NTRansition?
<b>Example</b>	STAT:QUES:CAL:EXT:FAIL:NTR 1 EMI conducted align failure is not required.
Preset	0
Min	0
Max	32767
Status Bits/OPC dependencies	Sequential command
Initial S/W Revision	Prior to A.02.00

### Questionable Calibration Extended Failure Positive Transition

This command determines which bits in the Questionable Calibration Extended Failure Condition register will set the corresponding bit in the Questionable Calibration Extended Failure Event register when the condition register bit has a positive transition (0 to 1). The variable <integer> is the sum of the decimal values of the bits that you want to enable.

Mode	All
<b>Remote Command</b>	:STATus:QUESTionable:CALibration:EXTended:FAILure:PTRansition <integer> :STATus:QUESTionable:CALibration:EXTended:FAILure:PTRansition?
<b>Example</b>	STAT:QUES:CAL:EXT:FAIL:PTR 1 EMI conducted align failure is required.
Preset	32767
Min	0
Max	32767

Status Bits/OPC dependencies	Sequential command
Initial S/W Revision	Prior to A.02.00

### Questionable Calibration Extended Needed Register

"Questionable Calibration Extended Needed Condition " on page 123

"Questionable Calibration Extended Needed Enable " on page 123

"Questionable Calibration Extended Needed Event Query " on page 124

"Questionable Calibration Extended Needed Negative Transition " on page 124

"Questionable Calibration Extended Needed Positive Transition " on page 125

### Questionable Calibration Extended Needed Condition

This query returns the decimal value of the sum of the bits in the Questionable Calibration Extended Needed Condition register.

**NOTE** The data in this register is continuously updated and reflects the current conditions.

Mode	All
<b>Remote Command</b>	:STATus:QUESTionable:CALibration:EXTended:NEEDed:CONDition?
<b>Example</b>	STAT:QUES:CAL:EXT:NEED:COND?
Preset	0
Status Bits/OPC dependencies	Sequential command
Initial S/W Revision	Prior to A.02.00

### Questionable Calibration Extended Needed Enable

This command determines which bits in the Questionable Calibration Extended Needed Condition Register will set bits in the Questionable Calibration Extended Needed Event register, which also sets bit 14 of the Questionable Calibration Register. The variable <integer> is the sum of the decimal values of the bits you want to enable.

Mode	All
<b>Remote Command</b>	:STATus:QUESTionable:CALibration:EXTended:NEEDed:ENABle <integer> :STATus:QUESTionable:CALibration:EXTended:NEEDed:ENABle?
<b>Example</b>	STAT:QUES:CAL:EXT:NEED:ENAB 2 Can be used to query if an EMI conducted alignment is needed.
Preset	32767
Min	0

Max	32767
Status Bits/OPC dependencies	Sequential command
Initial S/W Revision	Prior to A.02.00

### Questionable Calibration Extended Needed Event Query

This query returns the decimal value of the sum of the bits in the Questionable Calibration Extended Needed Event register.

**NOTE**

The register requires that the associated PTR or NTR filters be set before a condition register bit can set a bit in the event register. The data in this register is latched until it is queried. Once queried, the register is cleared.

Mode	All
<b>Remote Command</b>	:STATus:QUESTionable:CALibration:EXTended:NEEDed[:EVENT]?
<b>Example</b>	STAT:QUES:CAL:EXT:NEED?
Preset	0
Status Bits/OPC dependencies	Sequential command
Initial S/W Revision	Prior to A.02.00

### Questionable Calibration Extended Needed Negative Transition

This command determines which bits in the Questionable Calibration Extended Needed Condition register will set the corresponding bit in the Questionable Calibration Extended Needed Event register when the condition register bit has a negative transition (1 to 0). The variable <integer> is the sum of the decimal values of the bits that you want to enable.

Mode	All
<b>Remote Command</b>	:STATus:QUESTionable:CALibration:EXTended:NEEDed:NTRansition <integer> :STATus:QUESTionable:CALibration:EXTended:NEEDed:NTRansition?
<b>Example</b>	STAT:QUES:CAL:EXT:NEED:NTR 2 Align EMI conducted is not required.
Preset	0
Min	0
Max	32767
Status Bits/OPC dependencies	Sequential command
Initial S/W Revision	Prior to A.02.00

### Questionable Calibration Extended Needed Positive Transition

This command determines which bits in the Questionable Calibration Extended Needed Condition register will set the corresponding bit in the Questionable Calibration Extended Needed Event register when the condition register bit has a positive transition (0 to 1). The variable <integer> is the sum of the decimal values of the bits that you want to enable.

Mode	All
<b>Remote Command</b>	:STATus:QUEStionable:CALibration:EXTended:NEEDED:PTRansition <integer> :STATus:QUEStionable:CALibration:EXTended:NEEDED:PTRansition?
<b>Example</b>	STAT:QUES:CAL:EXT:NEED:PTR 2 Align EMI conducted is required.
Preset	32767
Min	0
Max	32767
Status Bits/OPC dependencies	Sequential command
Initial S/W Revision	Prior to A.02.00

### Questionable Frequency Register

"Questionable Frequency Condition " on page 125

"Questionable Frequency Enable " on page 126

"Questionable Frequency Event Query " on page 126

"Questionable Frequency Negative Transition " on page 126

"Questionable Frequency Positive Transition " on page 127

### Questionable Frequency Condition

This query returns the decimal value of the sum of the bits in the Questionable Frequency Condition register.

**NOTE** The data in this register is continuously updated and reflects the current conditions.

Mode	All
<b>Remote Command</b>	:STATus:QUEStionable:FREQuency:CONDition?
<b>Example</b>	STAT:QUES:FREQ:COND?
Preset	0
Status Bits/OPC dependencies	Sequential command
Initial S/W Revision	Prior to A.02.00

### Questionable Frequency Enable

This command determines which bits in the Questionable Frequency Condition Register will set bits in the Questionable Frequency Event register, which also sets the Frequency Summary bit (bit 5) in the Questionable Register. The variable <integer> is the sum of the decimal values of the bits you want to enable.

Mode	All
<b>Remote Command</b>	:STATus:QUEStionable:FREQuency:ENABle <integer> :STATus:QUEStionable:FREQuency:ENABle?
<b>Example</b>	STAT:QUES:FREQ:ENAB 2 Frequency Reference Unlocked will be reported to the Frequency Summary of the Status Questionable register.
Preset	32767
Min	0
Max	32767
Status Bits/OPC dependencies	Sequential command
Initial S/W Revision	Prior to A.02.00

### Questionable Frequency Event Query

This query returns the decimal value of the sum of the bits in the Questionable Frequency Event register.

**NOTE**

The register requires that the associated PTR or NTR filters be set before a condition register bit can set a bit in the event register. The data in this register is latched until it is queried. Once queried, the register is cleared.

Mode	All
<b>Remote Command</b>	:STATus:QUEStionable:FREQuency[:EVENT]?
<b>Example</b>	STAT:QUES:FREQ?
Preset	0
Status Bits/OPC dependencies	Sequential command
Initial S/W Revision	Prior to A.02.00

### Questionable Frequency Negative Transition

This command determines which bits in the Questionable Frequency Condition register will set the corresponding bit in the Questionable Frequency Event register when the condition register bit has a negative transition (1 to 0). The variable <integer> is the sum of the decimal values of the bits that you want to enable.

Mode	All
------	-----

<b>Remote Command</b>	:STATus:QUESTionable:FREQuency:NTRansition <integer> :STATus:QUESTionable:FREQuency:NTRansition?
<b>Example</b>	STAT:QUES:FREQ:NTR 2 Frequency Reference 'regained lock' will be reported to the Frequency Summary of the Status Questionable register.
Preset	0
Min	0
Max	32767
Status Bits/OPC dependencies	Sequential command
Initial S/W Revision	Prior to A.02.00

### Questionable Frequency Positive Transition

This command determines which bits in the Questionable Frequency Condition register will set the corresponding bit in the Questionable Frequency Event register when the condition register bit has a positive transition (0 to 1). The variable <integer> is the sum of the decimal values of the bits that you want to enable.

Mode	All
<b>Remote Command</b>	:STATus:QUESTionable:FREQuency:PTRansition <integer> :STATus:QUESTionable:FREQuency:PTRansition?
<b>Example</b>	STAT:QUES:FREQ:PTR 2 Frequency Reference 'became unlocked' will be reported to the Frequency Summary of the Status Questionable register.
Preset	32767
Min	0
Max	32767
Status Bits/OPC dependencies	Sequential command
Initial S/W Revision	Prior to A.02.00

### Questionable Integrity Register

"Questionable Integrity Condition " on page 127

"Questionable Integrity Enable " on page 128

"Questionable Integrity Event Query " on page 128

"Questionable Integrity Negative Transition " on page 129

"Questionable Integrity Positive Transition " on page 129

### Questionable Integrity Condition

This query returns the decimal value of the sum of the bits in the Questionable Integrity Condition register.

**NOTE**

The data in this register is continuously updated and reflects the current conditions.

Mode	All
Remote Command	:STATus:QUESTionable:INTEgrity:CONDition?
Example	STAT:QUES:INT:COND?
Preset	0
Status Bits/OPC dependencies	Sequential command
Initial S/W Revision	Prior to A.02.00

### Questionable Integrity Enable

This command determines which bits in the Questionable Integrity Condition Register will set bits in the Questionable Integrity Event register, which also sets the Integrity Summary bit (bit 9) in the Questionable Register. The variable <integer> is the sum of the decimal values of the bits you want to enable.

Mode	All
Remote Command	:STATus:QUESTionable:INTEgrity:ENABle <integer> :STATus:QUESTionable:INTEgrity:ENABle?
Example	STAT:QUES:INT:ENAB 8 Measurement Uncalibrated Summary will be reported to the Integrity Summary of the Status Questionable register.
Preset	32767
Min	0
Max	32767
Status Bits/OPC dependencies	Sequential command
Initial S/W Revision	Prior to A.02.00

### Questionable Integrity Event Query

This query returns the decimal value of the sum of the bits in the Questionable Integrity Event register.

**NOTE**

The register requires that the associated PTR or NTR filters be set before a condition register bit can set a bit in the event register. The data in this register is latched until it is queried. Once queried, the register is cleared.

Mode	All
Remote Command	:STATus:QUESTionable:INTEgrity[:EVENT]?
Example	STAT:QUES:INT?
Preset	0
Status Bits/OPC dependencies	Sequential command
Initial S/W Revision	Prior to A.02.00



### Questionable Integrity Negative Transition

This command determines which bits in the Questionable Integrity Condition register will set the corresponding bit in the Questionable Integrity Event register when the condition register bit has a negative transition (1 to 0)

The variable <integer> is the sum of the decimal values of the bits that you want to enable.

Mode	All
<b>Remote Command</b>	:STATus:QUEStionable:INTEgrity:NTRansition <integer> :STATus:QUEStionable:INTEgrity:NTRansition?
<b>Example</b>	STAT:QUES:INT:NTR 8 Measurement 'regained calibration' Summary will be reported to the Integrity Summary of the Status Questionable register.
Preset	0
Min	0
Max	32767
Status Bits/OPC dependencies	Sequential command
Initial S/W Revision	Prior to A.02.00

### Questionable Integrity Positive Transition

This command determines which bits in the Questionable Integrity Condition register will set the corresponding bit in the Questionable Integrity Event register when the condition register bit has a positive transition (0 to 1). The variable <integer> is the sum of the decimal values of the bits that you want to enable.

Mode	All
<b>Remote Command</b>	:STATus:QUEStionable:INTEgrity:PTRansition <integer> :STATus:QUEStionable:INTEgrity:PTRansition?
<b>Example</b>	STAT:QUES:INT:PTR 8 Measurement 'became uncalibrated' Summary will be reported to the Integrity Summary of the Status Questionable register.
Preset	32767
Min	0
Max	32767
Status Bits/OPC dependencies	Sequential command
Initial S/W Revision	Prior to A.02.00

### Questionable Integrity Signal Register

"Questionable Integrity Signal Condition" on page 130

"Questionable Integrity Signal Enable" on page 130

"Questionable Integrity Signal Event Query" on page 131

"Questionable Integrity Signal Negative Transition" on page 131

"Questionable Integrity Signal Positive Transition" on page 131

### Questionable Integrity Signal Condition

This query returns the decimal value of the sum of the bits in the Questionable Integrity Signal Condition register.

**NOTE** The data in this register is continuously updated and reflects the current conditions.

Mode	All
<b>Remote Command</b>	:STATus:QUESTionable:INTEgrity:SIGNal:CONDition?
<b>Example</b>	STAT:QUES:INT:SIGN:COND?
Preset	0
Status Bits/OPC dependencies	Sequential command
Initial S/W Revision	Prior to A.02.00

### Questionable Integrity Signal Enable

This command determines which bits in the Questionable Integrity Signal Condition Register will set bits in the Questionable Integrity Signal Event register, which also sets the Integrity Summary bit (bit 9) in the Questionable Register. The variable <integer> is the sum of the decimal values of the bits you want to enable.

Mode	All
<b>Remote Command</b>	:STATus:QUESTionable:INTEgrity:SIGNal:ENABle <integer> :STATus:QUESTionable:INTEgrity:SIGNal:ENABle?
<b>Example</b>	STAT:QUES:INT:SIGN:ENAB 4 Burst Not Found will be reported to the Integrity Summary of the Status Questionable register.
Preset	32767
Min	0
Max	32767
Status Bits/OPC dependencies	Sequential command
Initial S/W Revision	Prior to A.02.00

### Questionable Integrity Signal Event Query

This query returns the decimal value of the sum of the bits in the Questionable Integrity Signal Event register.

**NOTE**

The register requires that the associated PTR or NTR filters be set before a condition register bit can set a bit in the event register. The data in this register is latched until it is queried. Once queried, the register is cleared.

Mode	All
<b>Remote Command</b>	:STATus:QUESTionable:INTEgrity:SIGNal[:EVENT]?
<b>Example</b>	STAT:QUES:INT:SIGN?
Preset	0
Status Bits/OPC dependencies	Sequential command
Initial S/W Revision	Prior to A.02.00

### Questionable Integrity Signal Negative Transition

This command determines which bits in the Questionable Integrity Signal Condition register will set the corresponding bit in the Questionable Integrity Signal Event register when the condition register bit has a negative transition (1 to 0). The variable <integer> is the sum of the decimal values of the bits that you want to enable.

Mode	All
<b>Remote Command</b>	:STATus:QUESTionable:INTEgrity:SIGNal:NTRansition <integer> :STATus:QUESTionable:INTEgrity:SIGNal:NTRansition?
<b>Example</b>	STAT:QUES:INT:SIGN:NTR 4 Burst found will be reported to the Integrity Summary of the Status Questionable register.
Preset	0
Min	0
Max	32767
Status Bits/OPC dependencies	Sequential command
Initial S/W Revision	Prior to A.02.00

### Questionable Integrity Signal Positive Transition

This command determines which bits in the Questionable Integrity Signal Condition register will set the corresponding bit in the Questionable Integrity Signal Event register when the condition register bit has a positive transition (0 to 1). The variable <integer> is the sum of the decimal values of the bits that you want to enable.

Mode	All
<b>Remote Command</b>	:STATus:QUEStionable:INTEgrity:SIGNal:PTRansition <integer> :STATus:QUEStionable:INTEgrity:SIGNal:PTRansition?
<b>Example</b>	STAT:QUES:INT:SIGN:PTR 4 Burst not found will be reported to the Integrity Summary of the Status Questionable register.
Preset	32767
Min	0
Max	32767
Status Bits/OPC dependencies	Sequential command
Initial S/W Revision	Prior to A.02.00

### Questionable Integrity Uncalibrated Register

"Questionable Integrity Uncalibrated Condition " on page 132

"Questionable Integrity Uncalibrated Enable " on page 132

"Questionable Integrity Uncalibrated Event Query " on page 133

"Questionable Integrity Uncalibrated Negative Transition " on page 133

"Questionable Integrity Uncalibrated Positive Transition " on page 134

### Questionable Integrity Uncalibrated Condition

This query returns the decimal value of the sum of the bits in the Questionable Integrity Uncalibrated Condition register.

**NOTE**

The data in this register is continuously updated and reflects the current conditions.

Mode	All
<b>Remote Command</b>	:STATus:QUEStionable:INTEgrity:UNCalibrated:CONDition?
<b>Example</b>	STAT:QUES:INT:UNC:COND?
Preset	0
Status Bits/OPC dependencies	Sequential command
Initial S/W Revision	Prior to A.02.00

### Questionable Integrity Uncalibrated Enable

This command determines which bits in the Questionable Integrity Uncalibrated Condition Register will set bits in the Questionable Integrity Uncalibrated Event register, which also sets the Data Uncalibrated Summary bit (bit 3) in the Questionable Integrity Register. The variable <integer> is the sum of the decimal values of the bits you want to enable.

Mode	All
<b>Remote Command</b>	:STATus:QUEStionable:INTEgrity:UNCalibrated:ENABle :STATus:QUEStionable:INTEgrity:UNCalibrated:ENABle?
<b>Example</b>	STAT:QUES:INT:UNC:ENAB 1 Oversweep (Meas Uncal) will be reported to the Integrity Summary of the Status Questionable register.
Preset	32767
Min	0
Max	32767
Status Bits/OPC dependencies	Sequential command
Initial S/W Revision	Prior to A.02.00

### Questionable Integrity Uncalibrated Event Query

This query returns the decimal value of the sum of the bits in the Questionable Integrity Uncalibrated Event register.

**NOTE**

The register requires that the associated PTR or NTR filters be set before a condition register bit can set a bit in the event register. The data in this register is latched until it is queried. Once queried, the register is cleared.

Mode	All
<b>Remote Command</b>	:STATus:QUEStionable:INTEgrity:UNCalibrated[:EVENT]?
<b>Example</b>	STAT:QUES:INT:UNC?
Preset	0
Status Bits/OPC dependencies	Sequential command
Initial S/W Revision	Prior to A.02.00

### Questionable Integrity Uncalibrated Negative Transition

This command determines which bits in the Questionable Integrity Uncalibrated Condition register will set the corresponding bit in the Questionable Integrity Uncalibrated Event register when the condition register bit has a negative transition (1 to 0). The variable <integer> is the sum of the decimal values of the bits that you want to enable.

Mode	All
<b>Remote Command</b>	:STATus:QUEStionable:INTEgrity:UNCalibrated:NTRansition <integer> :STATus:QUEStionable:INTEgrity:UNCalibrated:NTRansition?
<b>Example</b>	STAT:QUES:INT:UNC:NTR 1 Oversweep cleared will be reported to the Integrity Summary of the Status Questionable register.

Preset	0
Min	0
Max	32767
Status Bits/OPC dependencies	Sequential command
Initial S/W Revision	Prior to A.02.00

### Questionable Integrity Uncalibrated Positive Transition

This command determines which bits in the Questionable Integrity Uncalibrated Condition register will set the corresponding bit in the Questionable Integrity Uncalibrated Event register when the condition register bit has a positive transition (0 to 1). The variable <integer> is the sum of the decimal values of the bits that you want to enable.

Mode	All
<b>Remote Command</b>	:STATus:QUEStionable:INTEgrity:UNCalibrated:PTRansition <integer> :STATus:QUEStionable:INTEgrity:UNCalibrated:PTRansition?
<b>Example</b>	STAT:QUES:INT:UNC:PTR 1 Oversweep (Meas Uncal) occurred will be reported to the Integrity Summary of the Status Questionable register.
Preset	32767
Min	0
Max	32767
Status Bits/OPC dependencies	Sequential command
Initial S/W Revision	Prior to A.02.00

### Questionable Power Register

"Questionable Power Condition " on page 134

"Questionable Power Enable " on page 135

"Questionable Power Event Query " on page 135

"Questionable Power Negative Transition " on page 136

"Questionable Power Positive Transition " on page 136

### Questionable Power Condition

This query returns the decimal value of the sum of the bits in the Questionable Power Condition register.

**NOTE**

The data in this register is continuously updated and reflects the current conditions.

Mode	All
<b>Remote Command</b>	:STATus:QUESTionable:POWer:CONDition?
<b>Example</b>	STAT:QUES:POW:COND?
Preset	0
Status Bits/OPC dependencies	Sequential command
Initial S/W Revision	Prior to A.02.00

### Questionable Power Enable

This command determines which bits in the Questionable Power Condition Register will set bits in the Questionable Power Event register, which also sets the Power Summary bit (bit 3) in the Questionable Register. The variable <integer> is the sum of the decimal values of the bits you want to enable.

Mode	All
<b>Remote Command</b>	:STATus:QUESTionable:POWer:ENABle <integer> :STATus:QUESTionable:POWer:ENABle?
<b>Example</b>	STAT:QUES:POW:ENAB 32 50 MHz Input Pwr too High for Cal will be reported to the Power Summary of the Status Questionable register.
Preset	32767
Min	0
Max	32767
Status Bits/OPC dependencies	Sequential command
Initial S/W Revision	Prior to A.02.00

### Questionable Power Event Query

This query returns the decimal value of the sum of the bits in the Questionable Power Event register.

#### NOTE

The register requires that the associated PTR or NTR filters be set before a condition register bit can set a bit in the event register. The data in this register is latched until it is queried. Once queried, the register is cleared.

Mode	All
<b>Remote Command</b>	:STATus:QUESTionable:POWer[:EVENT]?
<b>Example</b>	STAT:QUES:POW?
Preset	0
Status Bits/OPC dependencies	Sequential command
Initial S/W Revision	Prior to A.02.00

### Questionable Power Negative Transition

This command determines which bits in the Questionable Power Condition register will set the corresponding bit in the Questionable Power Event register when the condition register bit has a negative transition (1 to 0). The variable <integer> is the sum of the decimal values of the bits that you want to enable.

Mode	All
<b>Remote Command</b>	:STATus:QUESTionable:POWer:NTRansition <integer> :STATus:QUESTionable:POWer:NTRansition?
<b>Example</b>	STAT:QUES:POW:NTR 32 50 MHz Input Power became OK for Cal will be reported to the Power Summary of the Status Questionable register.
Preset	0
Min	0
Max	32767
Status Bits/OPC dependencies	Sequential command
Initial S/W Revision	Prior to A.02.00

### Questionable Power Positive Transition

This command determines which bits in the Questionable Power Condition register will set the corresponding bit in the Questionable Power Event register when the condition register bit has a positive transition (0 to 1). The variable <integer> is the sum of the decimal values of the bits that you want to enable.

Mode	All
<b>Remote Command</b>	:STATus:QUESTionable:POWer:PTRansition <integer> :STATus:QUESTionable:POWer:PTRansition?>
<b>Example</b>	STAT:QUES:POW:PTR 32 50 MHz Input Power became too high for Cal will be reported to the Power Summary of the Status Questionable register.
Preset	32767
Min	0
Max	32767
Status Bits/OPC dependencies	Sequential command
Initial S/W Revision	Prior to A.02.00

### Questionable Temperature Register

"Questionable Temperature Condition" on page 137



"Questionable Temperature Enable" on page 137

"Questionable Temperature Event Query" on page 137

"Questionable Temperature Negative Transition" on page 138

"Questionable Temperature Positive Transition" on page 138

### Questionable Temperature Condition

This query returns the decimal value of the sum of the bits in the Questionable Temperature Condition register.

**NOTE**

The data in this register is continuously updated and reflects the current conditions.

Mode	All
<b>Remote Command</b>	:STATus:QUEStionable:TEMPerature:CONDition?
<b>Example</b>	STAT:QUES:TEMP:COND?
Preset	0
Status Bits/OPC dependencies	Sequential command
Initial S/W Revision	Prior to A.02.00

### Questionable Temperature Enable

This command determines which bits in the Questionable Temperature Condition Register will set bits in the Questionable Temperature Event register, which also sets the Temperature Summary bit (bit 4) in the Questionable Register. The variable <integer> is the sum of the decimal values of the bits you want to enable.

Mode	All
<b>Remote Command</b>	:STATus:QUEStionable:TEMPerature:ENABle <integer> :STATus:QUEStionable:TEMPerature:ENABle?
<b>Example</b>	STAT:QUES:TEMP:ENAB 1 Reference Oscillator Oven Cold will be reported to the Temperature Summary of the Status Questionable register.
Preset	32767
Min	0
Max	32767
Status Bits/OPC dependencies	Sequential command
Initial S/W Revision	Prior to A.02.00

### Questionable Temperature Event Query

This query returns the decimal value of the sum of the bits in the Questionable Temperature Event register.

**NOTE**

The register requires that the associated PTR or NTR filters be set before a condition register bit can set a bit in the event register. The data in this register is latched until it is queried. Once queried, the register is cleared

Mode	All
<b>Remote Command</b>	:STATus:QUEStionable:TEMPerature[:EVENT]?
<b>Example</b>	STAT:QUES:TEMP?
Preset	0
Status Bits/OPC dependencies	Sequential command
Initial S/W Revision	Prior to A.02.00

### Questionable Temperature Negative Transition

This command determines which bits in the Questionable Temperature Condition register will set the corresponding bit in the Questionable Temperature Event register when the condition register bit has a negative transition (1 to 0). The variable <integer> is the sum of the decimal values of the bits that you want to enable.

Mode	All
<b>Remote Command</b>	:STATus:QUEStionable:TEMPerature:NTRansition <integer> :STATus:QUEStionable:TEMPerature:NTRansition?
<b>Example</b>	STAT:QUES:TEMP:NTR 1 Reference Oscillator Oven not cold will be reported to the Temperature Summary of the Status Questionable register.
Preset	0
Min	0
Max	32767
Status Bits/OPC dependencies	Sequential command
Initial S/W Revision	Prior to A.02.00

### Questionable Temperature Positive Transition

This command determines which bits in the Questionable Temperature Condition register will set the corresponding bit in the Questionable Temperature Event register when the condition register bit has a positive transition (0 to 1). The variable <integer> is the sum of the decimal values of the bits that you want to enable.

Mode	All
<b>Remote Command</b>	:STATus:QUEStionable:TEMPerature:PTRansition <integer> :STATus:QUEStionable:TEMPerature:PTRansition?
<b>Example</b>	STAT:QUES:TEMP:PTR 1 Reference Oscillator Oven became cold will be reported to the

---

Temperature Summary of the Status Questionable register.	
Preset	32767
Min	0
Max	32767
Status Bits/OPC dependencies	Sequential command
Initial S/W Revision	Prior to A.02.00

---

## IEEE 488.2 Common Commands

The instrument supports the following subset of IEEE 488.2 Common Commands, as defined in Chapter 10 of [IEEE Standard 488.2-1992](#). As indicated in the detailed descriptions, some of these commands correspond directly to instrument front-panel key functionality, while others are available only as remote commands.

Command	Description
*CAL?	Align Now "All " on page 297
*CLS	"Clear Status " on page 142
*ESE	"Standard Event Status Enable " on page 142
*ESE?	
*ESR?	"Standard Event Status Register Query " on page 143
*IDN?	"Identification Query " on page 143
*OPC	"Operation Complete " on page 144
*OPC?	
*OPT?	"Query Instrument Options " on page 145
*RCL	"Recall Instrument State " on page 145
*RST	"*RST (Remote Command Only)" on page 146
*SAV	"Save Instrument State " on page 146
*SRE	"Service Request Enable " on page 146
*SRE?	
*STB?	"Status Byte Query " on page 147
*TRG	"Trigger " on page 147
*TST?	"Self Test Query " on page 147
*WAI	"Wait-to-Continue " on page 148

### All

(In MXE the key label is "All (plus RF Presel 20 Hz – 3.6 GHz)")Immediately executes an alignment of all subsystems In MXE, the Align Now All is followed by additionally aligning the RF Preselector section, so in MXE, the key label contains the parenthetical note "(plus RF Presel 20 Hz – 3.6 GHz)". The instrument stops any measurement currently underway, performs the alignment, then restarts the measurement from the beginning (similar to pressing the Restart key).

If an interfering user signal is present at the RF Input, the alignment is performed on all subsystems except the RF. After completion, the Error Condition message "Align skipped: 50 MHz interference" or "Align skipped: 4.8 GHz interference" is generated. In addition the Error Condition message "Align Now, RF required" is generated, and bits 11 and 12 are set in the Status Questionable Calibration register.

The query form of the remote commands (:CALibration[:ALL]? or \*CAL?) invokes the alignment of all subsystems and returns a success or failure value. An interfering user signal is not grounds for failure; if the

alignment was able to succeed on all portions but unable to align the RF because of an interfering signal, the resultant will be the success value.

Successful completion of Align Now, All will clear the “Align Now, All required” Error Condition, and clear bit 14 in the Status Questionable Calibration register. It will also begin the elapsed time counter for Last Align Now, All Time, and capture the Last Align Now, All Temperature.

In the MXE, successful completion will also clear the “Align 20 Hz to 30 MHz required” Error Condition, the “Align 30 MHz to 3.6 GHz required” Error Condition, and the “Align 20 Hz to 3.6 GHz required” Error Condition, and clear bits 1 and bit 2 and clear the bit 1 in the Status Questionable Calibration Extended Needed register.

If the Align RF subsystem succeeded in aligning (no interfering signal present), the elapsed time counter begins for Last Align Now, RF Time, and the temperature is captured for the Last Align Now, RF Temperature. In addition the Error Conditions “Align skipped: 50 MHz interference” and “Align skipped: 4.8 GHz interference” are cleared, the Error Condition “Align Now, RF required” is cleared, and bits 11 and 12 are cleared in the Status Questionable Calibration register

Align Now, All can be interrupted by pressing the Cancel (ESC) front-panel key or remotely with Device Clear followed by the :ABORt SCPI command. When this occurs the Error Condition message “Align Now, All required” is generated, and bit 14 is set in the Status Questionable Condition register. This is because new alignment data may be employed for an individual subsystem, but not a cohesive set of data for all subsystems.

In many cases, you might find it more convenient to change alignments to Normal, instead of executing Align Now, All. When the Auto Align process transitions to Normal, the analyzer will immediately start to update only the alignments that have expired, thus efficiently restoring the alignment process.

<b>Key Path</b>	System, Alignments, Align Now
<b>Mode</b>	All
<b>Remote Command</b>	:CALibration[:ALL] :CALibration[:ALL]?
<b>Example</b>	:CAL
<b>Notes</b>	:CALibration[:ALL]? returns 0 if successful :CALibration[:ALL]? returns 1 if failed :CALibration[:ALL]? is the same as *CAL? While Align Now, All is performing the alignment, bit 0 in the Status Operation register is set. Completion, or termination, will clear bit 0 in the Status Operation register. This command is sequential; it must complete before further SCPI commands are processed. Interrupting the alignment from remote is accomplished by invoking Device Clear followed by the :ABORt command. Successful completion will clear bit 14 in the Status Questionable Calibration register. An interfering user signal is not grounds for failure of Align Now, All. However, bits 11 and 12 are set in the Status Questionable Calibration register to indicate Align Now, RF is required. An interfering user supplied signal will result in the instrument requiring an Align Now, RF with the interfering signal removed.
<b>Couplings</b>	Initializes the time for the Last Align Now, All Time. Records the temperature for the Last Align Now, All Temperature.

	If Align RF component succeeded, initializes the time for the Last Align Now, RF Time. If Align RF component succeeded, records the temperature for the Last Align Now, RF Temperature.
Status Bits/OPC dependencies	Bits 11, 12, or 14 may be set in the Status Questionable Calibration register.
Initial S/W Revision	Prior to A.02.00

Mode	All
Remote Command	*CAL?
Example	*CAL?
Notes	*CAL? returns 0 if successful *CAL? returns 1 if failed :CALibration[:ALL]? is the same as *CAL? See additional remarks described with :CALibration[:ALL]? Everything about :CALibration[:ALL]? is synonymous with *CAL? including all conditions, status register bits, and couplings
Initial S/W Revision	Prior to A.02.00

## Clear Status

Clears the status byte register. It does this by emptying the error queue and clearing all bits in all of the event registers. The status byte register summarizes the states of the other registers. It is also responsible for generating service requests.

Key Path	No equivalent key. Related key System, Show Errors, Clear Error Queue
Remote Command	*CLS
Example	*CLS Clears the error queue and the Status Byte Register.
Notes	For related commands, see the SYSTem:ERRor[:NEXT]? command. See also the STATus:PRESet command and all commands in the STATus subsystem.
Status Bits/OPC dependencies	Resets all bits in all event registers to 0, which resets all the status byte register bits to 0 also.
Backwards Compatibility Notes	In general the status bits used in the X-Series status system will be backwards compatible with ESA and PSA. However, note that all conditions will generate events that go into the event log, and some will also generate status bits.
Initial S/W Revision	Prior to A.02.00

## Standard Event Status Enable

Selects the desired bits from the standard event status enable register. This register monitors I/O errors and synchronization conditions such as operation complete, request control, query error, device

dependent error, status execution error, command error, and power on. The selected bits are OR'd to become a summary bit (bit 5) in the byte register which can be queried.

The query returns the state of the standard event status enable register.

Key Path	No equivalent key. Related key System, Show Errors, Clear Error Queue
<b>Remote Command</b>	*ESE <integer> *ESE?
<b>Example</b>	*ESE 36 Enables the Standard Event Status Register to monitor query and command errors (bits 2 and 5). *ESE? Returns a 36 indicating that the query and command status bits are enabled.
Notes	For related commands, see the STATus subsystem and SYSTem:ERRor[:NEXT]? commands.
Preset	255
State Saved	Not saved in state.
Min	0
Max	255
Status Bits/OPC dependencies	Event Enable Register of the Standard Event Status Register.
Initial S/W Revision	Prior to A.02.00

## Standard Event Status Register Query

Queries and clears the standard event status event register. (This is a destructive read.) The value returned is a hexadecimal number that reflects the current state (0/1) of all the bits in the register.

<b>Remote Command</b>	*ESR?
<b>Example</b>	*ESR? Returns a 1 if there is either a query or command error, otherwise it returns a zero.
Notes	For related commands, see the STATus subsystem commands.
Preset	0
Min	0
Max	255
Status Bits/OPC dependencies	Standard Event Status Register (bits 0 – 7).
Initial S/W Revision	Prior to A.02.00

## Identification Query

Returns a string of instrument identification information. The string will contain the model number, serial number, and firmware revision.

The response is organized into four fields separated by commas. The field definitions are as follows:

- Manufacturer

- Model
- Serial number
- Firmware version

Key Path	No equivalent key. See related key System, Show System.
Remote Command	*IDN?
Example	*IDN? Returns instrument identification information, such as: Keysight Technologies, N9020A, US01020004, A.01.02
Initial S/W Revision	Prior to A.02.00

### Operation Complete

The \*OPC command sets bit 0 in the standard event status register (SER) to “1” when pending operations have finished, that is when all overlapped commands are complete. It does not hold off subsequent operations. You can determine when the overlapped commands have completed either by polling the OPC bit in SER, or by setting up the status system such that a service request (SRQ) is asserted when the OPC bit is set.

The \*OPC? query returns a “1” after all the current overlapped commands are complete. So it holds off subsequent commands until the “1” is returned, then the program continues. This query can be used to synchronize events of other instruments on the external bus.

Remote Command	*OPC *OPC?
Example	INIT:CONT 0 Selects single sweeping. INIT:IMM Initiates a sweep. *OPC? Holds off any further commands until the sweep is complete.
Status Bits/OPC dependencies	Not global to all remote ports or front panel. *OPC only considers operation that was initiated on the same port as the *OPC command was issued from. *OPC is an overlapped command, but *OPC? is sequential.
Backwards Compatibility Notes	<ol style="list-style-type: none"> <li>1. The ESA/PSA/VSA products do not meet all the requirements for the *OPC command specified by IEEE 488.2. This is corrected for X-Series. This will sometimes cause behavior that is not backward compatible, but it will work as customers expect.</li> <li>2. Commands such as, *OPC/*OPC?/*WAI/*RST used to be global. They considered front panel operation in conjunction with the GPIB functionality. Now they are evaluated on a per channel basis. That is, the various rear panel remote ports and the front panel i/o are all considered separately. Only the functionality initiated on the port where the *OPC was sent, is considered for its operation.</li> <li>3. *OPC used to hold off until the operation bits were cleared. Now it holds off until all overlapping commands are completed. Also, earlier instruments did not wait for completion of all processes, only the ones identified here (in the STATus:OPERation register): Calibrating: monitored by PSA, ESA, VSA (E4406A) Sweeping: monitored by PSA, ESA, VSA (E4406A) Waiting for Trigger: monitored by PSA, ESA, VSA (E4406A)</li> </ol>



	Measuring: monitored by PSA and ESA (but not in all Modes). Paused: monitored by VSA (E4406A). Printing: monitored by VSA (E4406A). Mass memory busy: monitored by VSA (E4406A).
Initial S/W Revision	Prior to A.02.00

## Query Instrument Options

Returns a string of all the installed instrument options. It is a comma separated list with quotes, such as: "503,P03,PFR".

To be IEEE compliant, this command should return an arbitrary ascii variable that would not begin and end with quotes. But the quotes are needed to be backward compatible with previous SA products and software. So, the actual implementation will use arbitrary ascii. But quotes will be sent as the first and last ascii characters that are sent with the comma-separated option list.

<b>Remote Command</b>	*OPT?
Initial S/W Revision	Prior to A.02.00

## Recall Instrument State

This command recalls the instrument state from the specified instrument memory register.

- If the state being loaded has a newer firmware revision than the revision of the instrument, no state is recalled and an error is reported
- If the state being loaded has an equal firmware revision than the revision of the instrument, the state will be loaded.
- If the state being loaded has an older firmware revision than the revision of the instrument, the instrument will only load the parts of the state that apply to the older revision.

<b>Remote Command</b>	*RCL <register #>
<b>Example</b>	*RCL 7 Recalls the instrument state that is currently stored in register 7.
Notes	Registers 0 through 6 are accessible from the front panel in menu keys for Recall Registers.
Min	0
Max	127
Status Bits/OPC dependencies	The command is sequential.
Initial S/W Revision	Prior to A.02.00

### \*RST (Remote Command Only)

\*RST is equivalent to :SYST:PRES;:INIT:CONT OFF, which is a Mode Preset in the Single measurement state. This remote command is preferred over Mode Preset remote command - :SYST:PRES, as optimal remote programming occurs with the instrument in the single measurement state.

<b>Remote Command</b>	*RST
<b>Example</b>	*RST
<b>Notes</b>	Sequential Clears all pending OPC bits and the Status Byte is set to 0.
<b>Couplings</b>	A *RST will cause the currently running measurement to be aborted and cause the default measurement to be active. *RST gets the mode to a consistent state with all of the default couplings set.
<b>Backwards Compatibility Notes</b>	In legacy analyzers *RST did not set the analyzer to Single, but in the X-Series it does, for compliance with the IEEE 488.2 specification. In the X-Series, *RST does not do a *CLS (clear the status bits and the error queue). In legacy analyzers, *RST used to do the equivalent of SYSTem:PRESet, *CLS and INITiate:CONTinuous OFF. But to be 488.2 compliant, *RST in the X-Series does not do a *CLS.
<b>Initial S/W Revision</b>	Prior to A.02.00

### Save Instrument State

This command saves the current instrument state and mode to the specified instrument memory register.

<b>Remote Command</b>	*SAV <register #>
<b>Example</b>	*SAV 9 Saves the instrument state in register 9.
<b>Notes</b>	Registers 0 through 6 are accessible from the front panel in menu keys for Save Registers.
<b>Min</b>	0
<b>Max</b>	127
<b>Status Bits/OPC dependencies</b>	The command is sequential.
<b>Initial S/W Revision</b>	Prior to A.02.00

### Service Request Enable

This command enables the desired bits of the service request enable register.

The query returns the value of the register, indicating which bits are currently enabled.

<b>Remote Command</b>	*SRE <integer> *SRE?
<b>Example</b>	*SRE 22 Enables bits 1, 2, and 4 in the service request enable register.

Notes	For related commands, see the STATus subsystem and SYSTem:ERRor[:NEXT]? commands.
Preset	0
Min	0
Max	255
Status Bits/OPC dependencies	Service Request Enable Register (all bits, 0 - 7).
Initial S/W Revision	Prior to A.02.00

## Status Byte Query

Returns the value of the status byte register without erasing its contents.

<b>Remote Command</b>	*STB?
<b>Example</b>	*STB? Returns a decimal value for the bits in the status byte register. For example, if a 16 is returned, it indicates that bit 5 is set and one of the conditions monitored in the standard event status register is set.
Notes	See related command *CLS.
Status Bits/OPC dependencies	Status Byte Register (all bits, 0 - 7).
Initial S/W Revision	Prior to A.02.00

## Trigger

This command triggers the instrument. Use the :TRIGger[:SEQuence]:SOURce command to select the trigger source.

Key Path	No equivalent key. See related keys Single and Restart.
<b>Remote Command</b>	*TRG
<b>Example</b>	*TRG Triggers the instrument to take a sweep or start a measurement, depending on the current instrument settings.
Notes	See related command :INITiate:IMMediate.
Initial S/W Revision	Prior to A.02.00

## Self Test Query

This query performs the internal self-test routines and returns a number indicating the success of the testing. A zero is returned if the test is successful, 1 if it fails.

<b>Remote Command</b>	*TST?
<b>Example</b>	*TST? Runs the self-test routines and returns 0=passed, 1=some part failed.
Initial S/W Revision	Prior to A.02.00

## Wait-to-Continue

This command causes the instrument to wait until all overlapped commands are completed before executing any additional commands. There is no query form for the command.

<b>Remote Command</b>	*WAI
<b>Example</b>	INIT:CONT OFF; INIT;*WAI Sets the instrument to single sweep. Starts a sweep and waits for its completion.
<b>Status Bits/OPC dependencies</b>	Not global to all remote ports or front panel. *OPC only considers operation that was initiated on the same port as the *OPC command was issued from.
<b>Initial S/W Revision</b>	Prior to A.02.00

## 4 Input/Output Functions

## Input/Output

The Input/Output features are common across multiple Modes and Measurements. These common features are described in this section. See the Measurement description for information on features that are unique.

The Input/Output key accesses the keys that control the Input/Output parameters of the instrument. In general, these are functions associated with external connections to the analyzer, either to the inputs or the outputs. Since these connections tend to be fairly stable within a given setup, in general, the input/output settings do not change when you Preset the analyzer.

Other functions related to the input/output connections, but which tend to change on a measurement by measurement basis, can be found under the Trigger and AMPTD Y Scale keys. In addition, some of the digital I/O bus configurations can be found under the System key.

**NOTE**

The functions in the Input/Output menu are "global" (common) to all Modes (applications). But individual Input/Output functions only appear in a Mode if they apply to that Mode. Functions that apply to a Mode but not to all measurements in the Mode may be grayed-out in some measurements.

["Input/Output variables - Preset behavior" on page 151](#)

The Input Port selection is the first menu under the Input/Output key:

Key Path	Front-panel key
<b>Remote Command</b>	<code>[ :SENSe ] :FEED RF   AIQ   EMIXer</code> <code>[ :SENSe ] :FEED?</code>
<b>Example</b>	<code>:FEED RF</code> <code>:FEED?</code>
<b>Couplings</b>	The <code>[ :SENSe ] :FEED RF</code> command turns the calibrator OFF
<b>Preset</b>	This setting is unaffected by a Preset or power cycle. It survives a Mode Preset and mode changes. It is set to RF on a "Restore Input/Output Defaults" or "Restore System Defaults->All"
<b>State Saved</b>	Saved in instrument state
<b>Backwards Compatibility SCPI</b>	<code>[ :SENSe ] :FEED AREFERENCE</code> In the PSA the calibrator was one of the inputs and selected using the AREF parameter to the same <code>:FEED</code> command that switched the inputs. In the X-Series it is controlled in a separate menu and overrides the input selection. For code compatibility the <code>[ :SENSe ] :FEED AREFERENCE</code> command is provided, and is aliased to <code>[ :SENSe ] :FEED :AREF REF50</code> , which causes the input to be switched to the 50 MHz calibrator. The <code>[ :SENSe ] :FEED RF</code> command switches the input back to the RF port and turns the calibrator OFF, thus providing full compatibility with the PSA calibrator function. Note that after sending this, the query <code>[ :SENSe ] :FEED?</code> will NOT return "AREF" but instead the currently selected input.
<b>Backwards Compatibility SCPI</b>	<code>[ :SENSe ] :FEED IQ   IONLy   QONLy</code> <code>[ :SENSe ] :FEED?</code> The parameters <code>IQ   IONLy   QONLy</code> are supported for backwards compatibility with the E44406A. <code>[ :SENSe ] :FEED IQ</code> aliases to <code>[ :SENSe ] :FEED :IQ :TYPE IQ</code> <code>[ :SENSe ] :FEED IONLy</code> aliases to <code>[ :SENSe ] :FEED :IQ :TYPE IONLy</code>

	<p>[;SENSe]:FEED QONLY aliases to [;SENSe]:FEED:IQ:TYPE QONLY</p> <p>The query [;SENSe]:FEED? will always returns AIQ whatever the type of legacy parameters IQ   IONLY   QONLY has been used.</p>
Backwards Compatibility Notes	<p>Most of the settings in the X-Series Input/Output system, including External Gain, Amplitude Corrections settings and data, etc., are shared by all modes and are not changed by a mode switch. Furthermore, most variables in the Input/Output system key are not affected by Mode Preset. Both of these behaviors represent a departure from legacy behavior.</p> <p>In the X-Series. Input/Output settings are reset by using the "Restore Input/Output Defaults" function. They can also be reset to their default values through the System-&gt;Restore System Defaults-&gt; In/Out Config key or through the System -&gt;Restore System Defaults -&gt; All key (and corresponding SCPI).</p> <p>While this matches most use cases better, it does create some code compatibility issues. For example, Amplitude Corrections are no longer turned off by a Mode Preset, but instead by using the "Restore Input/Output Defaults" key/SCPI.</p> <p>Although Input/Output settings are not part of each Mode's State, they are saved in the Save State files, so that all of the instrument settings can be recalled with Recall State, as in legacy instruments.</p>
Initial S/W Revision	Prior to A.02.00
<b>Remote Command</b>	<p>:INPut:MIXer EXTernal INTernal</p> <p>:INPut:MIXer?</p>
<b>Example</b>	<p>INP:MIX INT</p> <p>INP:MIX?</p>
Notes	<p>In legacy analyzers you choose between the Internal mixer or an External Mixer. In the X-Series, the External Mixer is one of the choices for the Input and is selected using the FEED command (:SENSe:FEED EXTMIxer).</p> <p>For compatibility, the INPut:MIXer EXTernal INTernal legacy command is mapped as follows:</p> <ol style="list-style-type: none"> <li>1. When INPut:MIXer EXTernal is received, SENSe:FEED EMIXer is executed.</li> <li>2. When INPut:MIXer INTernal is received, SENSe:FEED RF is executed.</li> <li>3. When INPut:MIXer? is received, the response will be INT if any input other than the external mixer is selected and EXT if the external mixer is selected</li> </ol>
Preset	INT
Backwards Compatibility Notes	<p>PSA supports the following SCPI Command :</p> <p>:INPut:MIXer:TYPE PRESelected UNPReselect</p> <p>:INPut:MIXer:TYPE?</p> <p>PXA does not support the :INPut:MIXer:TYPE command.</p>
Initial S/W Revision	A.08.01

## Input/Output variables - Preset behavior

Virtually all the input/output settings are NOT a part of mode preset. They can be set to their default value

by one of the three ways:

- by using the Restore Input/Output Defaults key on the first page of the input/output menu,
- by using the System->Restore System Defaults->Input/Output Settings or,
- by using the System -> Restore System Defaults->All. Also, they survive a Preset and a Power cycle.

A very few of the Input/Output settings do respond to a Mode Preset; for example, if the Calibrator is on it turns off on a Preset, and if DC coupling is in effect it switches to AC on a Preset. These exceptions are made in the interest of reliability and usability, which overrides the need for absolute consistency. Exceptions are noted in the SCPI table for the excepted functions.

## RF Input

Selects the front-panel RF input port to be the analyzer signal input. If RF is already selected, pressing this key accesses the RF input setup functions.

<b>Key Path</b>	<b>Input/Output</b>
<b>Example</b>	[:SENSe]:FEED RF
<b>Couplings</b>	The act of connecting the U7227A USB Preamplifier to one of the analyzer's USB ports will cause the Input to automatically switch to the RF Input. If the RF Calibrator is on, it is turned off. Subsequently disconnecting the USB Preamp from USB does not change the Input selection nor restore the previous selection.
<b>Readback</b>	The RF input port, RF coupling, and current input impedance settings appear on this key as: "XX, YY, ZZ" where XX is RF, RF2, RFIO1, RFIO2, depending on what input is selected (only appears on analyzers with multiple RF inputs) YY is AC or DC ZZ is 50Ω or 75Ω
<b>Initial S/W Revision</b>	Prior to A.02.00
<b>Modified at S/W Revision</b>	A.14.00

## Input Z Correction

Sets the input impedance for unit conversions. This affects the results when the y-axis unit is voltage or current units (dBmV, dBμV, dBμA, V, A), but not when it is power units (dBm, W). The impedance you select is for computational purposes only, since the actual impedance is set by internal hardware to 50 ohms. Setting the computational input impedance to 75 ohms is useful when using a 75 ohm to 50 ohm adapter to measure a 75 ohm device on an analyzer with a 50 ohm input impedance.

There are a variety of ways to make 50 to 75 ohm transitions, such as impedance transformers or minimum loss pads. The choice of the solution that is best for your measurement situation requires balancing the amount of loss that you can tolerate with the amount of measurement frequency range that you need. If you are using one of these pads/adaptors with the Input Z Corr function, you might also want to use the Ext Gain key. This function is used to set a correction value to compensate for the gain (loss) through your pad. This correction factor is applied to the displayed measurement values.



Key Path	Input/Output, RF Input
Remote Command	[ :SENSe ] :CORRection:IMPedance [ :INPut ] [ :MAGNitude ] 50   75 [ :SENSe ] :CORRection:IMPedance [ :INPut ] [ :MAGNitude ] ?
Example	CORR:IMP 75 sets the input impedance correction to 75 ohms. CORR:IMP?
Couplings	In the N9000A option C75, when RF Input 2 is selected, the Input Z Correction will automatically change to 75 ohms. You may then change it to whatever is desired. When the main RF Input is selected, the Input Z Correction will automatically change to 50 ohms. You may then change it to whatever is desired.
Preset	This is unaffected by a Preset but is set to 50 ohms on a "Restore Input/Output Defaults" or "Restore System Defaults->All" Some instruments/options may have 75 ohms available.
State Saved	Saved in instrument state
Readback	50 $\Omega$ or 75 $\Omega$ . Current setting reads back to the RF key.
Initial S/W Revision	Prior to A.02.00

## RF Coupling

Specifies alternating current (AC) or direct current (DC) coupling at the analyzer RF input port. Selecting AC coupling switches in a blocking capacitor that blocks any DC voltage present at the analyzer input. This decreases the input frequency range of the analyzer, but prevents damage to the input circuitry of the analyzer if there is a DC voltage present at the RF input.

In AC coupling mode, you can view signals below the corner frequency of the DC block, but below a certain frequency the amplitude accuracy is not specified. The frequency below which specifications do not apply is:

X-Series Model	Lowest Freq for meeting specs when AC coupled	Lowest Freq for meeting specs when DC coupled
N9000A-503/507	100 kHz	n/a
N9000A-C75 Input 2	1 MHz	n/a
N9000A-513/526	10 MHz	9 kHz
N9010A	10 MHz	9 kHz
N9020A	10 MHz	20 Hz
N9030A	10 MHz	3 Hz

Some amplitude specifications apply only when coupling is set to DC. Refer to the appropriate amplitude specifications and characteristics for your analyzer.

When operating in DC coupled mode, ensure protection of the analyzer input circuitry by limiting the DC part of the input level to within 200 mV of 0 Vdc. In AC or DC coupling, limit the input RF power to +30 dBm (1 Watt).

<b>Key Path</b>	Input/Output, RF Input
<b>Remote Command</b>	:INPut:COUPling AC DC :INPut:COUPling?
<b>Example</b>	INP:COUP DC
<b>Dependencies</b>	This key does not appear in models that are always AC coupled. When the SCPI command to set DC coupling is sent to these models, it results in the error "Illegal parameter value; This model is always AC coupled" In these models, the SCPI query INP:COUP? always returns AC. This key does not appear in models that are always DC coupled. When the SCPI command to set AC coupling is sent to these models, it results in the error "Illegal parameter value; This instrument is always DC coupled" In these models, the SCPI query INP:COUP? always returns DC.
<b>Preset</b>	AC on models that support AC coupling On models that are always DC coupled, such as millimeter wave models (frequency ranges 30 GHz and above), the preset is DC.
<b>State Saved</b>	Saved in instrument state.
<b>Initial S/W Revision</b>	Prior to A.02.00
<b>Modified at S/W Revision</b>	A.03.00

## RF Input Port

Specifies the RF input port used. The RF Input Port key only appears on units with multiple inputs, and lets you switch between the two inputs.

Switching from the RF input port to one of the RFIO ports, on units that have them, changes the receiver performance of the instrument.

<b>Key Path</b>	Input/Output, RF Input
<b>Remote Command</b>	[ :SENSe ] :FEED:RF:PORT [ :INPut ] RFIN   RFIN2   RFIO1   RFIO2   RFIO3   RFIO4 [ :SENSe ] :FEED:RF:PORT [ :INPut ] ?
<b>Example</b>	:FEED:RF:PORT RFIN
<b>Dependencies</b>	This key only appears in models that support multiple inputs. If the SCPI command is sent with unsupported parameters in any other model, an error is generated, -221.1900, "Settings conflict;option not installed" When any input is selected in a measurement that does not support it, the "No result; Meas invalid with this input" error condition occurs, and the measurement returns invalid data when queried.
<b>Preset</b>	This is unaffected by Mode Preset but is set to RF on a "Restore Input/Output Defaults" or "Restore System Defaults -> All"
<b>State Saved</b>	Saved in instrument state
<b>Readback</b>	The current RF Input Port selected is read back to this key
<b>Backwards</b>	INPut<1 2>:TYPE INPUT1   INPUT2

<b>Compatibility SCPI</b>	INPut<1   2>:TYPE?
	Included for R&S ESU compatibility. In the MXE, the INPUT1 parameter is aliased to RFIN and the INPUT2 parameter is aliased to RFIN2
Initial S/W Revision	A.05.01
Modified at S/W Revision	A.14.00

## RF Input

Specifies using the main RF port for the current measurement

Key Path	Input/Output, RF Input, RF Input Port
Example	:FEED:RF:PORT RFIN
ReadBack	RF Input
Initial S/W Revision	A.05.01
Modified at S/W Revision	A.14.00

## RF Input 2

Specifies using the second RF port, if supported, for the current measurement.

See "[More Information](#)" on page 155

Key Path	Input/Output, RF Input, RF Input Port
Example	:FEED:RF:PORT RFIN2
Couplings	<p>When switching from Input 1 to Input 2:</p> <ul style="list-style-type: none"> <li>• If the Stop Freq is above the Max Freq, it is set to the Max Freq, otherwise it does not change.</li> <li>• If the Start Freq is above (Max Freq – Min Span), it is set to (Max Freq – Min Span), otherwise it does not change.</li> </ul> <p>When switching from Input 2 to Input 1, neither the Start Freq nor the Stop Freq change.</p> <p>For the Swept SA measurement, Min Span is 10 Hz. This may vary from measurement to measurement.</p>
ReadBack	RF Input 2
Initial S/W Revision	A.05.01

## More Information

In models with two inputs, the second input usually has a different maximum frequency than the first input. For your convenience, the actual “Max Freq” value is allowed to go slightly higher than the nominal Max Freq for the second input, just as is the case with the first input.

Model	Nominal Input 2 Max Freq	Absolute Input 2 Max Freq	Transition rule for switching from Input 1 to Input 2
N9038A	1 GHz	1.000025 GHz	<ul style="list-style-type: none"> <li>• If the Stop Freq is above 1.000025 GHz, it is set to 1.000025 GHz, otherwise it does not change.</li> <li>• If the Start Freq is above 1.000024990 Hz, Start Freq is set to 1.000024990 Hz and Span to 10 Hz, otherwise nothing changes.</li> </ul>
N9000A with option C75	1.5 GHz	1.58 GHz	<ul style="list-style-type: none"> <li>• If the Stop Freq is above 1.58 GHz, it is set to 1.58 GHz, otherwise it does not change.</li> <li>• If the Start Freq is above 1.579999990 GHz, Start Freq is set to 1.579999990 GHz and Span to 10 Hz, otherwise nothing changes</li> </ul>

## RF Preselector

In models that support the RF Preselector, such as MXE (N9038A), this key allows you to turn the preselector on and off.

### NOTE

When using the RF Preselector, if your measurement starts below 3.6 GHz and finishes above 3.6 GHz, the preselector bypass switch will have to switch in and out for every measurement. When this is the case, you will hear a clicking sound from the instrument and a warning message will be displayed: “Settings Alert:Mechanical switch cycling”. You are advised to avoid such setups as much as possible, to minimize switch wear. Pressing Mode Preset will reset the Stop Freq to 3.6 GHz and get you out of this state, or you can manually set the Stop Freq to be below 3.6 GHz.

Key Path	Input/Output, RF Input
Mode	All
Remote Command	[:SENSe]:POWer[:RF]:RFPreselector[:STATe] 1 0 ON OFF [:SENSe]:POWer[:RF]:RFPreselector[:STATe]?
Example	:POW:RFPS 1
Example	:INP:PRES:STAT ON
Notes	[:SENSe]:POWer[:RF]:RFPreselector[:STATe] 1 ON. Sets to full compliance measurement. [:SENSe]:POWer[:RF]:RFPreselector[:STATe] 0 OFF. Sets to pre-compliance measurement.
Dependencies	<p>The RF Preselector is not available in all measurements. The key is grayed out in measurements that do not support it, unless you are in a Mode in which no measurements support it, in that case the key does not appear at all. If the preselector is unavailable it is forced to Off. Attempting to turn it on or off in measurements that do not support it generates an error message: -221.3200, Settings conflict; Feature not supported for this measurement.</p> <p>The RF Preselector is not available when FFT Sweep Type is manually selected. Attempting to turn it on or off when this is the case generates an error message: “-221, Settings conflict; RF Presel unavailable when Sweep Type=Manual FFT”.</p> <p>This key only appears in Modes that support the RF Preselector, in other Modes, setting or querying the SCPI will generate an error.</p>

	This key only appears in models that support the RF Preselector, in other models, setting or querying the SCPI will generate an error.
Preset	It is set to Off when the selected mode is SA. If the selected mode is EMI Receiver, then it will be set to On.
<b>Backwards Compatibility SCPI</b>	INPut<1 2>:PRESelection[:STATe] ON OFF INPut<1 2>:PRESelection[:STATe]?  Included for R&S ESU compatibility
Initial S/W Revision	A.05.01

## I/Q

This feature is not available unless the "[Baseband I/Q \(Option BBA\)](#)" on page 157 is installed.

Selects the front-panel I/Q input ports to be the analyzer signal input. If I/Q is already selected, pressing this key accesses the I/Q setup menu.

Key Path	Input/Output
Mode	BASIC, CDMA2K, EDGE GSM, TDSCMDA, VSA89601, WIMAX OFDMA, LTE, LTETDD, LTEAFDD, LTEATDD, DCATV, DTMB (CTTB), DVB-T/H with T2, CMMB, ISDBT, WCDMA, VXA, CDMA1XEV
<b>Example</b>	FEED AIQ
Notes	Not all measurements support the use of the I/Q signal input. When I/Q is selected in a measurement that does not support it, the "No Result; Meas invalid with I/Q inputs" error condition message appears. This is error 135
Initial S/W Revision	Prior to A.02.00

## Baseband I/Q (Option BBA)

The Baseband I/Q functionality is a hardware option. It is option BBA. If the option is not installed, none of the I/Q functionality is enabled.

The Baseband I/Q has four input ports and one output port. The input ports are I, I-bar, Q, and Q-bar. The I and I-bar together compose the I channel and the Q and Q-bar together compose the Q channel. Each channel has two modes of operation, Single-Ended (also called "unbalanced") and Differential Input (also called "balanced"). When in Single-Ended operation, only the main port (I or Q) is used and the complementary port (I-bar or Q-bar) is ignored. When in Differential Input mode, both main and complementary ports are used.

The input settings (range, attenuation, skew, impedance, external gain) apply to the channels, not the individual ports.

The system supports a variety of 1 M $\Omega$  input passive probes as well as the Agilent 113x Series active differential probes using the Infinimax probe interface.

The Agilent 113x Series active probes can be used for both single ended and differential measurements. In either case a single connection is made for each channel (on either the I or Q input). The input is automatically configured to 50  $\Omega$  single ended and the probe power is supplied through the Infinimax interface. The probe can be configured for a variety of input coupling and low frequency rejection modes. In addition, a wide range of offset voltages and probe attenuation accessories are supported at the probe interface. The active probe has the advantage that it does not significantly load the circuit under test, even with unity gain probing.

With passive 1 M $\Omega$  probes, the probe will introduce a capacitive load on the circuit, unless higher attenuation is used at the probe interface. Higher attenuation reduces the signal level and degrades the signal-to-noise-ratio of the measurement. Passive probes are available with a variety of attenuation values for a moderate cost. Most Agilent passive probes can be automatically identified by the system, setting the input impedance setting required as well as the nominal attenuation. For single ended measurements a single probe is used for each channel. Other passive probes can be used, with the attenuation and impedance settings configured manually.

For full differential measurements, the system supports probes on each of the four inputs. The attenuation of the probes should be the same for good common mode rejection and channel match.

Both active and passive probes in single ended and differential configurations can be calibrated. This calibration uses the Cal Out BNC connection and a probe connection accessory. The calibration achieves excellent absolute gain flatness in a probed measurement. It matches both the gain and frequency response of the I and Q channels as well as any delay skew, resulting in high accuracy in derived measurements such as Error Vector Magnitude (EVM).

When a probe is connected a status message will be displayed. The message will indicate if calibration data is available or not. Calibration data is saved for each type of probe (including "none") for each port and will be reapplied whenever that type of probe is re-connected to the same port. For probes with EEPROM identification, the calibration data will be stored based on the unique probe identifier and will reapply data for that particular probe if it is available. The data will not follow a probe from one port to another. For probes without EEPROM identification, the instrument cannot distinguish between different probes of the same type and it will use the data from the last calibration for that probe type on that port.

When in differential mode, both the main and complementary probes are expected to be of the same type.

In some situations, the I and Q channels should be configured identically. In other situations it is convenient to control them independently. Some menus have a "Q Same as I" setting that will cause the Q channel configuration to mirror the I channel configuration, avoiding the overhead of double data entry when the channels should be the same.

The output port is for calibrating the I/Q input ports, although it can also be manually controlled.

There are two types of calibrations available: cable calibration and probe calibration. The cable calibration will guide the user through connecting each input port in turn. All ports must be calibrated together. The probe calibration is done for a specific channel (I or Q). If in Single-Ended mode, only the main port is calibrated. When in Differential Input mode, the user is guided through calibrating both main and complementary ports.

The front panel I/Q port LEDs indicate the current state of that port. On (green) indicates it is active, and off (dark) indicates it is not in use. For example, the Cal Out port LED is on if and only if there is signal coming out of that port.

The input is a context and some parameters have separate values for each context. The SCPI for these parameters has an optional "[:RF|IQ]" node. If the specific context is omitted, the command acts on the current input context's value. Here are the parameters that are input context sensitive:

- Center Frequency
- Trigger Source

It is important to distinguish between the I and Q input ports and the displayed I and Q data values. The I and Q input ports feed into a digital receiver that does digital tuning and filtering. The I and Q data seen by the user (either on the display or through SCPI) corresponds to the real ("I") and the imaginary ("Q") output from the digital receiver. When the input path is I+jQ or I Only and the center frequency is 0 Hz the I input ends up in as the real output from the receiver and appears as "I" data. Likewise, when the input path is I+jQ and the center frequency is 0 Hz, the Q input ends up as the imaginary output from the receiver and appears as "Q" data. However, when the input path is Q Only, the Q input is sent to the receiver as Q+j0, so the receiver output has the Q input coming out on the real output, and so in Q Only, the signal from the Q input port appears as the "I" data. Another situation where the I and Q data do not necessarily correspond directly to the I and Q inputs is when the center frequency is non-zero. The digital processing involved in the tuning is a complex operation. This will result in I Only data appearing as both "I" and "Q" data, the same as that signal would appear if seen through the RF input port.

### Baseband I/Q Remote Language Compatibility

For the Agilent E4406A VSA Series Transmitter Tester, Option B7C provided baseband I/Q inputs. Code compatibility has been provided to allow many of the commands for option B7C to function properly with the X-Series. The X-Series has hardware differences and additional capabilities (e.g., E4406A does not have independent settings of I & Q nor does it provide for probe calibrations) which make 100% compatibility impossible.

1. The following commands are supported:

```
:CALibration:IQ:FLATness
```

```
:INPut:IMPedance:IQ U50|B50|U1M|B1M
```

```
:INPut:IMPedance:REFerence <integer>
```

2. The [:SENSE]:FEED RF|IQ|IONLY|QONLY|AREFERENCE|IFALIGN command supports all parameters except IFALIGN. The FEED? query will return only RF|AIQ|AREF.

3. The following commands are not supported:

```
:CALibration:GIQ
```

```
:CALibration:IQ:CMR
```

```
:INPut:IQ:ALIGN OFF|ON|0|1
```

The Rohde & Schwarz FSQ-B71 also provides baseband I/Q inputs. A certain amount of code compatibility is provided in the X-Series, however hardware differences make this a somewhat limited set.

Supported:

The "<1|2>" is supported as "[1]".

```
INPut<1|2>:IQ:BALanced[:STATE] ON | OFF
```

INPut<1|2>:IQ:TYPE I | Q | IQ

INPut<1|2>:IQ:IMPedance LOW | HIGH

Not Supported:

INPut<1|2>:SElect AIQ | RF

TRACe<1|2>:IQ:DATA:FORMat COMPatible | IQBLock | IQPair>

TRACe<1|2>:IQ:DATA:MEMory? <offset samples>, <# of samples>

TRACe<1|2>:IQ:DATA?

TRACe<1|2>:IQ:SET <filter type>, <rbw>, <sample rate>, <trigger source>, <trigger slope>, <pretrigger samples>, <# of samples>

TRACe<1|2>:IQ:SRATe 10.0kHz to 81.6MHz

TRACe<1|2>:IQ[:STATe] ON|OFF

The Rohde & Schwarz FMU has the following SCPI, which is not supported (these commands start/abort the probe calibration procedure, which is manually interactive from the front panel):

CALibration:ABORt

CALibration:PROBe[:START]

## I/Q Path

Selects which I/Q input channels are active. The LED next to each I/Q input port will be on when that port is active.

The analysis bandwidth for each channel is the same as that of the instrument. For example, the base N9020A has a bandwidth of 10 MHz. With I/Q input the I and Q channels would each have an analysis bandwidth of 10 MHz, giving 20 MHz of bandwidth when the I/Q Path is I+jQ. With option B25, the available bandwidth becomes 25 MHz, giving 25 MHz each to I and Q and 50 MHz to I+jQ.

I/Q voltage to power conversion processing is dependent on the I/Q Path selected.

- With I+jQ input we know that the input signal may not be symmetrical about 0 Hz, because it has a complex component. Therefore, above 0 Hz only the positive frequency information is displayed, and below 0 Hz only the negative frequency information is displayed.
- With all other Input Path selections, the input signal has no complex component and therefore is always symmetrical about 0 Hz. In this case, by convention, the power conversion shows the combined voltage for both the positive and negative frequencies. The information displayed below 0 Hz is the mirror of the information displayed above 0 Hz. This results in a power reading 6.02 dB higher (for both) than would be seen with only the positive frequency voltage. Note also that, in this case the real signal may have complex modulation embedded in it, but that must be recovered by further signal processing.

Key Path	Input/Output, I/Q
<b>Remote Command</b>	[ :SENSe ] :FEED:IQ:TYPE IQ   IONLY   QONLY [ :SENSe ] :FEED:IQ:TYPE?
<b>Example</b>	Set the input to be both the I and Q channels, combined as I + j * Q.



	FEED:IQ:TYPE IQ
Preset	IQ
State Saved	Yes This is unaffected by a Preset but is set to the default value on a "Restore Input/Output Defaults" or "Restore System Defaults->All"
Range	I+jQ   I Only   Q Only
Readback Text	I+jQ   I Only   Q Only
Initial S/W Revision	Prior to A.02.00

<b>Remote Command</b>	:INPut [1] :IQ:TYPE IQ I Q :INPut [1] :IQ:TYPE?
Notes	For R&S FSQ-B71 compatibility
Preset	IQ
Initial S/W Revision	Prior to A.02.00

### I+jQ

Sets the signal input to be both the I and Q channels. The I and Q channel data will be combined as  $I + j * Q$ .

Key Path	Input/Output, I/Q, I/Q Path
<b>Example</b>	Set the input to be both the I and Q channels, combined as $I + j * Q$ . FEED:IQ:TYPE IQ
Initial S/W Revision	Prior to A.02.00

### I Only

Sets the signal input to be only the I channel. The Q channel will be ignored. The data collected is still complex. When the center frequency is 0 the imaginary part will always be zero, but for any other center frequency both the real and imaginary parts will be significant.

Key Path	Input/Output, I/Q, I/Q Path
<b>Example</b>	Set the input to be only the I channel. FEED:IQ:TYPE IONL
Initial S/W Revision	Prior to A.02.00

### Q Only

Sets the signal input to be only the Q channel. The I channel will be ignored. The Q channel will be sent to the digital receiver block as  $Q+j0$ . The receiver's output is still complex. When the center frequency is 0 the

imaginary part will always be zero, but for any other center frequency both the real and imaginary parts will be significant. Note that since the receiver's real output is displayed as the "I" data, when the center frequency is 0, the Q Only input appears as the "I" data.

Key Path	Input/Output, I/Q, I/Q Path
<b>Example</b>	Set the input to be only the Q channel. FEED:IQ:TYPE QONL
Initial S/W Revision	Prior to A.02.00

## I Setup

Access the channel setup parameters for the I channel.

Key Path	Input/Output, I/Q
Initial S/W Revision	Prior to A.02.00

## I Differential Input

Selects differential input on or off for the I channel. For differential input (also called balanced input), the analyzer uses both main and complementary ports. When differential input is off (also called single-ended or unbalanced input), the analyzer uses only the main port.

Key Path	Input/Output, I/Q, I Setup
<b>Remote Command</b>	:INPut:IQ[:I]:DIFFerential OFF ON 0 1 :INPut:IQ[:I]:DIFFerential?
<b>Example</b>	Put the I channel in Differential Input mode INP:IQ:DIFF ON
Notes	When I Differential Input = On, the analyzer will check for attenuation mismatches between the I and I-bar ports. If the difference in attenuation values exceeds 0.5 dB a Settings Alert error condition, error 159 will be set. When I Differential Input = On, and IQ Path is I+jQ, the Q Differential input must also be On. Similarly, when I Differential Input = Off, and IQ Path is I+jQ, the Q Differential input must also be Off. If the states of the two inputs do not match, an error condition message is generated, 159;Settings Alert;I/Q mismatch:Differential.
Couplings	Some active probes include built-in differential capability. When one of these probes is sensed, this key is disabled. Since the differential capability is handled in the probe, the Analyzer will use only the main port and the key will show that the Analyzer's Differential Input mode is Off (indicating that the complementary port is not in use). When Q Same as I is On, the value set for I will also be copied to Q.
Preset	Off
State Saved	Yes This is unaffected by a Preset but is set to the default value on a "Restore Input/Output Defaults" or "Restore System Defaults->All"

Range	Off   On
Initial S/W Revision	Prior to A.02.00
<hr/>	
<b>Remote Command</b>	:INPut [1] :IQ:BAnced[:STATe] OFF ON 0 1 :INPut [1] :IQ:BAnced[:STATe] ?
Notes	For R&S FSQ-B71 compatibility, with no independent settings for the I and Q channels. Therefore, it is tied only to the I channel and does not provide an equivalent for the Q channel. For proper operation of the backwards compatibility command Q Same as I should be set to On.
Preset	OFF
Initial S/W Revision	Prior to A.02.00

## I Input Z

Selects the input impedance for the I channel. The impedance applies to both the I and I-bar ports.

The input impedance controls the hardware signal path impedance match. It is not used for converting voltage to power. The voltage to power conversion always uses the Reference Z parameter. The Reference Z parameter applies to both I and Q channels.

Key Path	Input/Output, I/Q, I Setup
<b>Remote Command</b>	:INPut [1] :IQ[:I] :IMPedance LOW HIGH :INPut [1] :IQ[:I] :IMPedance ?
<b>Example</b>	Set the I channel input impedance to 1 M $\Omega$ INP:IQ:IMP HIGH
Notes	LOW = 50 $\Omega$ , HIGH = 1 M $\Omega$ When IQ Path is I+jQ, the I Input Z setting must be the same as the Q Input Z setting. If the settings of the two inputs do not match, an error condition message is generated, 159;Settings Alert;I/Q mismatch:Input Z.
Couplings	Input impedance is a built-in characteristic of a probe. Therefore, whenever a probe is sensed, this key is disabled and the value is set to match the probe. When no probe is sensed on Q and Q Same as I is On, the value set for I will also be copied to Q.
Preset	LOW
State Saved	Yes This is unaffected by a Preset but is set to the default value on a "Restore Input/Output Defaults" or "Restore System Defaults->All"
Range	50 $\Omega$   1 M $\Omega$
Initial S/W Revision	Prior to A.02.00

### I Skew

Sets the skew factor for the I channel. The skew will shift the channel's data in time. Use this to compensate for differences in the electrical lengths of the input paths due to cabling.

Key Path	Input/Output, I/Q, I Setup
Remote Command	[[:SENSe]:CORRection:IQ[:I]:SKEW <seconds> [:SENSe]:CORRection:IQ[:I]:SKEW?
Example	Delay the data for the I channel by 10 ns. CORR:IQ:SKEW 10 ns
Preset	0
State Saved	Yes This is unaffected by Preset but is set to the default value on a "Restore Input/Output Defaults" or "Restore System Defaults->All"
Range	0 s to 100 ns
Min	0 s
Max	+100 ns
Initial S/W Revision	Prior to A.02.00

### I Probe

Access the probe setup parameters for the I channel. See ["I/Q Probe Setup" on page 172](#).

Key Path	Input/Output, I/Q, I Setup
State Saved	No
Readback Text	[<I port probe id> This is reporting the type of probe sensed on the I port. There is no parameter for overriding what is sensed.
Initial S/W Revision	Prior to A.02.00

### Attenuation

The attenuation is part of the calibration data stored with the probe type and is initially the value that was returned by the last calibration. You can modify this value and any changes will be stored with the calibration data and will survive power cycles and presets. When a probe calibration is performed the attenuation value will be overwritten by the calibration.

Key Path	Input/Output, I/Q, I Setup   Q Setup, I Probe   Q Probe
Remote Command	[[:SENSe]:CORRection:IQ:I Q:ATTenuation:RATio <real> [:SENSe]:CORRection:IQ:I Q:ATTenuation:RATio?
Example	Set the attenuation for the current I probe to 100.00:1. CORR:IQ:I:ATT:RAT 100

Notes	Each probe type has its own attenuation setting. As probes are changed the attenuation value will reflect the new probe's setting. Changing the attenuation affects only the current probe type's setting and leaves all others unchanged.  When the IQ Path is I+jQ, the Q probe attenuation setting must match the I Probe attenuation setting within 1 dB. If this is not the case, an error condition message is generated, 159;Settings Alert;I/Q mismatch:Attenuation.
Preset	Each probe type has its own default. The default for the "Unknown" probe type is 1:1.
State Saved	Saved with probe calibration data. It survives a power cycle and is not affected by a Preset or Restore.
Range	0.001 to 10000
Min	0.001
Max	10000
Initial S/W Revision	Prior to A.02.00

This is an alternate form of the SCPI that allows input as a power instead of a ratio.

<b>Remote Command</b>	<code>[ :SENSe ] :CORRection:IQ:I Q:ATTenuation &lt;rel_ampl&gt;</code> <code>[ :SENSe ] :CORRection:IQ:I Q:ATTenuation?</code>
<b>Example</b>	Set the attenuation for the current I probe type to 100.00:1. CORR:IQ:I:ATT 20 dB
Range	-60 dB to +80 dB
Min	-60 dB
Max	+80 dB
Initial S/W Revision	Prior to A.02.00

## Calibrate

Invokes the guided probe calibration. The guided probe calibration is context sensitive and depends on the channel (I or Q) and the Differential Input state. The calibration is only performed on the selected channel. When Differential Input is on, both the probe attached to the main port and the probe attached to the complementary port are calibrated. When Differential Input is off, only the probe attached to the main port is calibrated. See "[I/Q Guided Calibration](#)" on page 208.

Key Path	Input/Output, I/Q, I Setup   Q Setup, I Probe   Q Probe, Coupling
Readback Text	The last calibration date, or if no calibration exists, "(empty)". Last: <cal date> <cal time> Example: Last: 8/22/2007 1:02:49 PM
Initial S/W Revision	Prior to A.02.00

### Clear Calibration

Clears the calibration data for the current port and probe. It does not clear the data for other probe types or other ports. If the sensed probe has EEPROM identification, only the data for that specific probe is cleared. After this command has completed, the probe calibration state will be the same as if no probe calibration had ever been performed for the specified channel and probe. The probe attenuation will be the default value for that probe type and the Cable Calibration frequency response corrections will be used. This command is dependent on the Differential Input state. When Differential Input is on, both the data for the probe attached to the main port and the data for the probe attached to the complementary port are cleared. When Differential Input is off, only data for the probe attached to the main port is cleared.

<b>Key Path</b>	Input/Output, I/Q, I Setup   Q Setup, I Probe   Q Probe
<b>Remote Command</b>	:CALibration:IQ:PROBe:I Q:CLEar
<b>Example</b>	Clear the calibration data for the I channel and the current probe (with EEPROM identification) or probe type (without EEPROM identification). :CAL:IQ:PROBe:I:CLE
<b>Initial S/W Revision</b>	Prior to A.02.00

### Q Setup

Access the channel setup parameters for the Q channel.

<b>Key Path</b>	Input/Output, I/Q
<b>Readback Text</b>	When Q Same as I is On the readback is "Q Same as I".
<b>Initial S/W Revision</b>	Prior to A.02.00

### Q Same as I

Many, but not all, usages require the I and Q channels have an identical setup. To simplify channel setup, the Q Same as I will cause the Q channel parameters to be mirrored from the I channel. That way you only need to set up one channel (the I channel). The I channel values are copied to the Q channel, so at the time Q Same as I is turned off the I and Q channel setups will be identical. This does not apply to Probe settings or to parameters that are determined by the probe.

<b>Key Path</b>	Input/Output, I/Q, Q Setup
<b>Remote Command</b>	:INPut:IQ:MIRRored OFF ON 0 1 :INPut:IQ:MIRRored?
<b>Example</b>	Turn off the mirroring of parameters from I to Q. INP:IQ:MIRR OFF
<b>Couplings</b>	Only displayed for the Q channel. When Yes, the I channel values for some parameters are mirrored (copied) to the Q channel. However, when a parameter is determined by the type of probe and a probe is sensed, the probe setting is always used and the I channel setting is ignored. The following parameters are mirrored:

	Differential Input (when not determined by probe) Input Z (when not determined by probe)
Preset	This is unaffected by a Preset but is set to the default value (Q Same as I set to "On") on a "Restore Input/Output Defaults" or "Restore System Defaults->All"
State Saved	Saved in instrument state
Range	On   Off
Readback Text	"Q Same as I" when On, otherwise none.
Initial S/W Revision	Prior to A.02.00

### Q Differential Input

Selects differential input on or off for the Q channel. For differential input (also called balanced input), the analyzer uses both the Q and Q-bar ports. When differential input is off (also called single-ended or unbalanced input), the analyzer uses only the Q port.

Key Path	Input/Output, I/Q, Q Setup
Remote Command	:INPut:IQ:Q:DIFFerential OFF ON 0 1 :INPut:IQ:Q:DIFFerential?
Example	Put the Q channel in Differential Input mode INP:IQ:Q:DIFF ON
Notes	When Differential Input = On, the analyzer will check for attenuation mismatches between the Q and Q-bar ports. If the difference in attenuation values exceeds 0.5 dB a Settings Alert error condition, error 159 will be set.  When Q Differential Input = On, and IQ Path is I+jQ, the I Differential input must also be On. Similarly, when Q Differential Input = Off, and IQ Path is I+jQ, the I Differential input must also be Off. If the states of the two inputs do not match, an error condition message is generated, 159;Settings Alert;I/Q mismatch:Differential.
Couplings	Some active probes include built-in differential capability. When one of these probes is sensed, this key is disabled. Since the differential capability is handled in the probe, the Analyzer will use only the main port and the key will show that the Analyzer's Differential Input mode is Off (indicating that the complementary port not in use).  When a differential probe is not sensed and Q Same as I is On, the value set for I will be copied to Q. This key is disabled when Q Same as I is On.
Preset	Off
State Saved	Yes  This is unaffected by a Preset but is set to the default value on a "Restore Input/Output Defaults" or "Restore System Defaults->All"
Range	Off   On
Initial S/W Revision	Prior to A.02.00

### Q Input Z

Selects the input impedance for the Q channel. The impedance applies to both the Q and Q-bar ports.

The input impedance controls the hardware signal path impedance match. It is not used for converting voltage to power. The voltage to power conversion always uses the Reference Z parameter. The Reference Z parameter applies to both I and Q channels.

Key Path	Input/Output, I/Q, Q Setup
Remote Command	:INPut [1] :IQ:Q:IMPedance LOW HIGH :INPut [1] :IQ:Q:IMPedance?
Example	Set the Q channel input impedance to 1 MΩ INP:IQ:Q:IMP HIGH
Notes	LOW = 50 Ω, HIGH = 1 MΩ When IQ Path is I+jQ, the I Input Z setting must be the same as the Q Input Z setting. If the settings of the two inputs do not match, an error condition message is generated, 159;Settings Alert;I/Q mismatch:Input Z.
Couplings	Input impedance is a built-in characteristic of a probe. Therefore, whenever a probe is sensed, this key is disabled and the value is set to match the probe. When no probe is sensed and Q Same as I is On, the value set for I will also be copied to Q. This key is disabled when Q Same as I is On.
Preset	LOW
State Saved	Yes This is unaffected by Preset but is set to the default value on a "Restore Input/Output Defaults" or "Restore System Defaults->All"
Range	50 Ω   1 MΩ
Initial S/W Revision	Prior to A.02.00

### Q Skew

Sets the skew factor for the Q channel. The skew will shift the channel's data in time. Use this to compensate for differences in the electrical lengths of the input paths due to cabling and probes.

Key Path	Input/Output, I/Q, Q Setup
Remote Command	[:SENSe]:CORRection:IQ:Q:SKEW <seconds> [:SENSe]:CORRection:IQ:Q:SKEW?
Example	Delay the data for the Q channel by 10 ns. CORR:IQ:Q:SKEW 10 ns
Preset	0
State Saved	Yes This is unaffected by a Preset but is set to the default value on a "Restore Input/Output Defaults" or "Restore System Defaults->All"
Range	0 s to 100 ns



Min	0 s
Max	+100 ns
Initial S/W Revision	Prior to A.02.00

## Q Probe

Accesses the probe setup parameters for the Q channel. See "[I/Q Probe Setup](#)" on page 172.

Key Path	Input/Output, I/Q, Q Setup
State Saved	No
Readback Text	[<Q port probe id> This is reporting the type of probe sensed on the Q port. There is no parameter for overriding what is sensed.
Initial S/W Revision	Prior to A.02.00

## Attenuation

The attenuation is part of the calibration data stored with the probe type and is initially the value that was returned by the last calibration. You can modify this value and any changes will be stored with the calibration data and will survive power cycles and presets. When a probe calibration is performed the attenuation value will be overwritten by the calibration.

Key Path	Input/Output, I/Q, I Setup   Q Setup, I Probe   Q Probe
<b>Remote Command</b>	[ :SENSE ] :CORREction:IQ:I Q:ATTenuation:RATio <real> [ :SENSE ] :CORREction:IQ:I Q:ATTenuation:RATio?
<b>Example</b>	Set the attenuation for the current I probe to 100.00:1. CORR:IQ:I:ATT:RAT 100
Notes	Each probe type has its own attenuation setting. As probes are changed the attenuation value will reflect the new probe's setting. Changing the attenuation affects only the current probe type's setting and leaves all others unchanged. When the IQ Path is I+jQ, the Q probe attenuation setting must match the I Probe attenuation setting within 1 dB. If this is not the case, an error condition message is generated, 159;Settings Alert;I/Q mismatch:Attenuation.
Preset	Each probe type has its own default. The default for the "Unknown" probe type is 1:1.
State Saved	Saved with probe calibration data. It survives a power cycle and is not affected by a Preset or Restore.
Range	0.001 to 10000
Min	0.001
Max	10000
Initial S/W Revision	Prior to A.02.00

This is an alternate form of the SCPI that allows input as a power instead of a ratio.

<b>Remote Command</b>	<code>[ :SENSe ] :CORRection:IQ:I Q:ATTenuation &lt;rel_amp1&gt;</code> <code>[ :SENSe ] :CORRection:IQ:I Q:ATTenuation?</code>
<b>Example</b>	Set the attenuation for the current I probe type to 100.00:1. <code>CORR:IQ:I:ATT 20 dB</code>
<b>Range</b>	-60 dB to +80 dB
<b>Min</b>	-60 dB
<b>Max</b>	+80 dB
<b>Initial S/W Revision</b>	Prior to A.02.00

### Calibrate

Invokes the guided probe calibration. The guided probe calibration is context sensitive and depends on the channel (I or Q) and the Differential Input state. The calibration is only performed on the selected channel. When Differential Input is on, both the probe attached to the main port and the probe attached to the complementary port are calibrated. When Differential Input is off, only the probe attached to the main port is calibrated. See "[I/Q Guided Calibration](#)" on page 208.

<b>Key Path</b>	Input/Output, I/Q, I Setup   Q Setup, I Probe   Q Probe, Coupling
<b>Readback Text</b>	The last calibration date, or if no calibration exists, "(empty)". Last: <cal date> <cal time> Example: Last: 8/22/2007 1:02:49 PM
<b>Initial S/W Revision</b>	Prior to A.02.00

### Clear Calibration

Clears the calibration data for the current port and probe. It does not clear the data for other probe types or other ports. If the sensed probe has EEPROM identification, only the data for that specific probe is cleared. After this command has completed, the probe calibration state will be the same as if no probe calibration had ever been performed for the specified channel and probe. The probe attenuation will be the default value for that probe type and the Cable Calibration frequency response corrections will be used. This command is dependent on the Differential Input state. When Differential Input is on, both the data for the probe attached to the main port and the data for the probe attached to the complementary port are cleared. When Differential Input is off, only data for the probe attached to the main port is cleared.

<b>Key Path</b>	Input/Output, I/Q, I Setup   Q Setup, I Probe   Q Probe
<b>Remote Command</b>	<code>:CALibration:IQ:PROBE:I Q:CLEar</code>
<b>Example</b>	Clear the calibration data for the I channel and the current probe (with EEPROM identification) or probe type (without EEPROM identification).

	:CAL:IQ:PROBe:I:CLE
Initial S/W Revision	Prior to A.02.00

## Reference Z

Sets the value of the impedance to be used in converting voltage to power for the I and Q channels. This does not change the hardware's path impedance (see "[I Input Z](#)" on page 163).

Key Path	Input/Output, I/Q
<b>Remote Command</b>	:INPut:IMPedance:REFeRence <integer> :INPut:IMPedance:REFeRence?
<b>Example</b>	Set the I/Q reference impedance to 50 $\Omega$ INP:IMP:REF 50
Preset	50 $\Omega$
State Saved	Yes This is unaffected by a Preset but is set to the default value on a "Restore Input/Output Defaults" or "Restore System Defaults->All"
Range	1 $\Omega$ to 1 M $\Omega$
Min	1 $\Omega$
Max	1 M $\Omega$
Initial S/W Revision	Prior to A.02.00

## I/Q Cable Calibrate...

The I/Q cable calibration creates correction data for each of the front panel I/Q ports. This calibration data is used whenever no probe specific calibration data is available. It is important that all ports are calibrated using the same short BNC cable so that the data is comparable from port to port.

The guided calibration (front panel only) will show connection diagrams and guide you through the isolation calibration and calibrating each port. The calibration data for each port is stored separately, so as soon as a port is calibrated that data is saved and will be used. If you press "Exit" to exit the calibration process, the data for the ports already completed will still be used. It is recommended that a calibration be completed once started, or if exited, that it be properly done before the next use of the I/Q ports. The "Next" button will perform the calibration for the current port and then proceed to the next step in the calibration procedure. The "Back" button will return to the prior port in the procedure. Both keys and dialog buttons are supplied for ease of use. The dialog buttons are for mouse use and the softkeys for front panel use.

The calibration can also be done via SCPI, but no connection diagrams will be shown. You will have to make the correct connections before issuing each port calibration command. Again, it is recommended that all ports be calibrated at the same time.

The instrument state remains as it was prior to entering the calibration procedure except while a port is actually being calibrated. Once a port is calibrated it returns to the prior state. A port calibration is in

process only from the time the "Next" button is pressed until the next screen is shown. For SCPI, this corresponds to the time from issuing the CAL:IQ:FLAT:I|B|Q|QB command until the operation is complete.

For example, if the prior instrument state is Cal Out = Off, Input = I+jQ, and Differential = Off, then up until the time the "Next" button is pressed the I Input and Q Input LEDs are on and the Cal Out, I-bar Input and Q-bar Input LEDs are off. Once the "Next" button is pressed for the I port calibration, only the Cal Out and I Input LEDs will be on and the others will be off. When the screen progresses to the next step ("Next" button again enabled), the prior state is restored and only the I Input and Q Input LEDs are on (Cal Out is off again).

The last calibration date and time for each port will be displayed. Any calibrations that are more than a day older than the most recent calibration will be displayed with the color amber.

Key Path	Input/Output, I/Q
Initial S/W Revision	Prior to A.02.00

### I/Q Probe Setup

The set of I/Q probe setup parameters will change based on the type of probe that is sensed. All probe types have the Attenuation parameter, and all probe types can be calibrated. The remaining parameters are only available for some probe types and will not be shown when not available. The probe type is determined by and reported for only for the I and Q ports, never the I-bar or Q-bar ports. The menu title will be "<ch>: <probe id>", where "<ch>" is either "I" or "Q" and "<probe id>" is the type of probe. For example, for the I Probe setup with an Agilent 1130A probe connected to the I port, the title will be "I: 1130A".

Probe calibration data is stored for each probe type for each channel. When no probe is sensed, the probe type "Unknown" is used, and this is also treated like a probe type with its own calibration data. When a probe is changed, the calibration data for that probe type for that port is restored. An advisory message will be displayed showing the new probe type and the calibration status. The calibration data is stored permanently (survives a power cycle) and is not affected by a Preset or any of the Restore commands. When the probe has EEPROM identification (most newer Agilent probes have this), the calibration data is stored by probe serial number and port, so if you have two probes of the same type, the correct calibration data will be used for each. For probes that do not have EEPROM identification, the calibration data is stored by probe type and port and the instrument cannot distinguish between different probes of the same type. In all cases (with or without EEPROM identification), the calibration data is port specific, so it will not follow a specific probe from port to port if the probe is moved.

The "Unknown" probe type is used whenever no probe is sensed. When no calibration data exists for "Unknown" the latest cable calibration data is used (see ["I/Q Guided Calibration" on page 208](#)).

### Attenuation

The attenuation is part of the calibration data stored with the probe type and is initially the value that was returned by the last calibration. You can modify this value and any changes will be stored with the calibration data and will survive power cycles and presets. When a probe calibration is performed the attenuation value will be overwritten by the calibration.

Key Path	Input/Output, I/Q, I Setup   Q Setup, I Probe   Q Probe
Remote Command	[ :SENSe ] :CORRection:IQ:I Q:ATTenuation:RATio <real> [ :SENSe ] :CORRection:IQ:I Q:ATTenuation:RATio?

<b>Example</b>	Set the attenuation for the current I probe to 100.00:1. CORR:IQ:I:ATT:RAT 100
<b>Notes</b>	Each probe type has its own attenuation setting. As probes are changed the attenuation value will reflect the new probe's setting. Changing the attenuation affects only the current probe type's setting and leaves all others unchanged.  When the IQ Path is I+jQ, the Q probe attenuation setting must match the I Probe attenuation setting within 1 dB. If this is not the case, an error condition message is generated, 159;Settings Alert;I/Q mismatch:Attenuation.
<b>Preset</b>	Each probe type has its own default. The default for the "Unknown" probe type is 1:1.
<b>State Saved</b>	Saved with probe calibration data. It survives a power cycle and is not affected by a Preset or Restore.
<b>Range</b>	0.001 to 10000
<b>Min</b>	0.001
<b>Max</b>	10000
<b>Initial S/W Revision</b>	Prior to A.02.00

This is an alternate form of the SCPI that allows input as a power instead of a ratio.

<b>Remote Command</b>	[ :SENSE ] :CORREction:IQ:I Q:ATTenuation <rel_ampl> [ :SENSE ] :CORREction:IQ:I Q:ATTenuation?
<b>Example</b>	Set the attenuation for the current I probe type to 100.00:1. CORR:IQ:I:ATT 20 dB
<b>Range</b>	-60 dB to +80 dB
<b>Min</b>	-60 dB
<b>Max</b>	+80 dB
<b>Initial S/W Revision</b>	Prior to A.02.00

## Offset

Some active probes have DC offset capability. When one of these probes is connected this control will be visible. The signal is adjusted for the DC offset before entering the analyzer's port. This allows for removal of a DC offset before reaching the analyzer's input port voltage limits. For example, a signal that varies 1 V peak-to-peak with a DC offset equal to the analyzer's max input voltage would exceed the input limits of the analyzer for half its cycle. Removing the DC offset allows the analyzer to correctly process the entire signal.

<b>Key Path</b>	Input/Output, I/Q, I Setup   Q Setup, I Probe   Q Probe
<b>Remote Command</b>	:INPut:OFFSet:I Q <voltage> :INPut:OFFSet:I Q?
<b>Example</b>	Remove a DC offset of -0.5 V from the I channel input. INP:OFFS:I -0.5

Notes	Only some probe types support Offset. For those that do, each probe type has its own Offset setting. As probes are changed the Offset value will reflect the new probe's setting. Changing the Offset affects only the current probe type's setting and leaves all others unchanged.
Preset	0 V
State Saved	Saved with probe calibration data. It survives power cycle and is not affected by Preset or Restore.
Range	-18 V to +18 V
Min	-18 V
Max	+18 V
Initial S/W Revision	Prior to A.02.00

### Coupling

Some probe types allow coupling to reject low frequencies. This will filter out the DC component of a signal that is composed of a DC bias plus some AC signal. This control is visible only for probe types that have this capability.

Key Path	Input/Output, I/Q, I Setup   Q Setup, I Probe   Q Probe
Remote Command	:INPut:COUPling:I Q DC LFR1 LFR2 :INPut:COUPling:I Q?
Example	Set the probe to low frequency rejection below 1.7 Hz. INP:COUP:I LFR1
Notes	Only some probe types support Coupling. For those that do, each probe type has its own Coupling setting. As probes are changed the Coupling value will reflect the new probe's setting. Changing the Coupling affects only the current probe type's setting and leaves all others unchanged.
Preset	DC
State Saved	Saved with probe calibration data. It survives a power cycle and is not affected by a Preset or Restore.
Range	DC   AC 1.7 Hz LFR1   AC 0.14 Hz LFR2
Readback Text	DC   LFR1   LFR2
Initial S/W Revision	Prior to A.02.00

### DC

Turns off low frequency rejection, allowing signals down to DC.

Key Path	Input/Output, I/Q, I Setup   Q Setup, I Probe   Q Probe, Coupling
Example	Turn off low frequency rejection on the I channel INP:COUP:I DC
Initial S/W Revision	Prior to A.02.00

**LFR1**

Turns on low frequency rejection, rejecting signal component lower than 1.7 Hz.

<b>Key Path</b>	Input/Output, I/Q, I Setup   Q Setup, I Probe   Q Probe, Coupling
<b>Example</b>	Turn on low frequency rejection on the I channel for frequencies lower than 1.7 Hz INP:COUP:I LFR1
<b>Initial S/W Revision</b>	Prior to A.02.00

**LFR2**

Turns on low frequency rejection, rejecting signal component lower than 0.14 Hz.

<b>Key Path</b>	Input/Output, I/Q, I Setup   Q Setup, I Probe   Q Probe, Coupling
<b>Example</b>	Turn on low frequency rejection on the I channel for frequencies lower than 0.14 Hz INP:COUP:I LFR2
<b>Initial S/W Revision</b>	Prior to A.02.00

**Calibrate**

Invokes the guided probe calibration. The guided probe calibration is context sensitive and depends on the channel (I or Q) and the Differential Input state. The calibration is only performed on the selected channel. When Differential Input is on, both the probe attached to the main port and the probe attached to the complementary port are calibrated. When Differential Input is off, only the probe attached to the main port is calibrated. See "[I/Q Guided Calibration](#)" on page 208.

<b>Key Path</b>	Input/Output, I/Q, I Setup   Q Setup, I Probe   Q Probe, Coupling
<b>Readback Text</b>	The last calibration date, or if no calibration exists, "(empty)". Last: <cal date> <cal time> Example: Last: 8/22/2007 1:02:49 PM
<b>Initial S/W Revision</b>	Prior to A.02.00

**Clear Calibration**

Clears the calibration data for the current port and probe. It does not clear the data for other probe types or other ports. If the sensed probe has EEPROM identification, only the data for that specific probe is cleared. After this command has completed, the probe calibration state will be the same as if no probe calibration had ever been performed for the specified channel and probe. The probe attenuation will be the default value for that probe type and the Cable Calibration frequency response corrections will be used. This command is dependent on the Differential Input state. When Differential Input is on, both the data for

the probe attached to the main port and the data for the probe attached to the complementary port are cleared. When Differential Input is off, only data for the probe attached to the main port is cleared.

<b>Key Path</b>	Input/Output, I/Q, I Setup   Q Setup, I Probe   Q Probe
<b>Remote Command</b>	:CALibration:IQ:PROBE:I Q:CLEar
<b>Example</b>	Clear the calibration data for the I channel and the current probe (with EEPROM identification) or probe type (without EEPROM identification). :CAL:IQ:PROBE:I:CLE
<b>Initial S/W Revision</b>	Prior to A.02.00

## RF Calibrator

Lets you choose a calibrator signal to look at or turns the calibrator "off".

<b>Key Path</b>	Input/Output
<b>Remote Command</b>	[[:SENSe]:FEED:AREFERENCE REF50 REF4800 OFF [:SENSe]:FEED:AREFERENCE?
<b>Example</b>	FEED:AREF REF50 selects the 50 MHz amplitude reference as the signal input. FEED:AREF REF4800 selects the 4.8 GHz amplitude reference as the signal input FEED:AREF OFF turns the calibrator "off" (switches back to the selected input – RF or I/Q)
<b>Dependencies</b>	Selecting an input (RF or I/Q) turns the Calibrator OFF. This is true whether the input is selected by the keys or with the [:SENSe]:FEED command.  The 4.8 GHz internal reference is only available in some models and frequency range options. If the 4.8 GHz reference is not present, the 4.8 GHz softkey will be blanked, and if the REF4800 parameter is sent, the analyzer will generate an error.
<b>Couplings</b>	When one of the calibrator signals is selected, the analyzer routes that signal (an internal amplitude reference) to the analyzer, and changes the main input selection to RF so the calibrator signal can be seen. When you turn the calibrator off it does not switch back to the previously selected input.
<b>Preset</b>	OFF
<b>State Saved</b>	Saved in instrument state
<b>Readback</b>	Off, 50 MHz, 4.8 GHz
<b>Initial S/W Revision</b>	Prior to A.02.00

<b>Remote Command</b>	:CALibration:SOURce:STATe OFF ON 0 1 :CALibration:SOURce:STATe?
<b>Notes</b>	For ESA backwards compatibility.  In the ESA the calibrator was a separate output which you connected to the input and switched on with this command.  In the X-Series, the ON parameter is aliased to the [:SENSe]:FEED:AREF REF50 command and the OFF parameter is aliased to [:SENSe]:FEED:AREF OFF.



	When CALibration:SOURce:STATe? is received, 1 will be returned if any of the references is selected and 0 if the Calibrator is "Off"
Preset	OFF
Initial S/W Revision	Prior to A.02.00

## 50 MHz

Selects the 50 MHz internal reference as the input signal.

Key Path	Input/Output, RF Calibrator
<b>Example</b>	:FEED:AREF REF50
Readback	50 MHz
Initial S/W Revision	Prior to A.02.00

## 4.8 GHz

Selects the 4.8 GHz internal reference as the input signal.

Key Path	Input/Output, RF Calibrator
<b>Example</b>	:FEED:AREF REF4800
Dependencies	The 4.8 GHz internal reference is only available in some models and frequency range options. If the 4.8 GHz reference is not present, the 4.8 GHz softkey will be blanked, and if the REF4800 parameter is sent, the analyzer will generate an error.
Readback	4.8 GHz
Initial S/W Revision	Prior to A.02.00
Modified at S/W Revision	A.03.00

## Off

Switches the input back to the selected input (RF or I/Q)

Key Path	Input/Output, RF Calibrator
<b>Example</b>	:FEED:AREF OFF
Readback	Off
Initial S/W Revision	Prior to A.02.00

## External Gain

Compensates for gain or loss in the measurement system outside the spectrum analyzer. The External Gain is subtracted from the amplitude readout (or the loss is added to the amplitude readout). So, the displayed signal level represents the signal level at the output of the device-under-test, which can be the input of an external device that provides gain or loss.

Entering an External Gain value does not affect the Reference Level, therefore the trace position on screen changes, as do all of the values represented by the trace data. Thus, the values of exported trace data, queried trace data, marker amplitudes, trace data used in calculations such as N dB points, trace math, peak threshold, etc., are all affected by External Gain. Changing the External Gain, even on a trace that is not updating, will immediately change all of the above, without new data needing to be taken.

### NOTE

Changing the External Gain causes the analyzer to immediately stop the current sweep and prepare to begin a new sweep. The data will not change until the trace data updates because the offset is applied to the data as it is taken. If a trace is exported with a nonzero External Gain, the exported data will contain the trace data with the offset applied.

In the Spectrum Analyzer mode, a Preamp is the common external device providing gain or loss. In a measurement application mode like GSM or W-CDMA, the gain or loss could be from a BTS (Base Transceiver Station) or an MS (Mobile Station). So in the Spectrum Analyzer mode MS and BTS would be grayed out and the only choice would be Ext Preamp. Similarly in some of the digital communications applications, Ext Preamp will be grayed out and you would have a choice of MS or BTS.

Key Path	Input/Output
Couplings	The Ext Preamp, MS, and BS keys may be grayed out depending on which measurement is currently selected. If any of the grayed out keys are pressed, or the equivalent SCPI command is sent, an advisory message is generated.
Readback	1-of-N selection   [variable]
Initial S/W Revision	Prior to A.02.00

## Ext Preamp

This function is similar to the reference level offset function. Both affect the displayed signal level. Ref Lvl Offset is a mathematical offset only, no analyzer configuration is affected. Ext Preamp gain is used when determining the auto-coupled value of the Attenuator. The External Gain value and the Maximum Mixer Level settings are both part of the automatic setting equation for the RF attenuation setting. (10 dB of Attenuation is added for every 10 dB of External Gain.)

Note that the Ref Lvl Offset and Maximum Mixer Level are described in the Amplitude section. They are reset by the instrument Preset. The External Preamp Gain is reset by the "Restore Input/Output Defaults" or "Restore System Defaults->All functions. . The External Gain is subtracted from the amplitude readout so that the displayed signal level represents the signal level at the output of the device-under-test, which is the input of the external device that is providing gain or loss.

["More Information" on page 179](#)

Key Path	Input/Output, External Gain
----------	-----------------------------

<b>Remote Command</b>	<code>[ :SENSe ] :CORRection:SA[:RF]:GAIN &lt;rel_ampl&gt;</code> <code>[ :SENSe ] :CORRection:SA[:RF]:GAIN?</code>
<b>Example</b>	CORR:SA:GAIN 10 sets the Ext Gain value to 10 dB CORR:SA:GAIN -10 sets the Ext Gain value to -10 dB (that is, an attenuation of 10 dB)
<b>Notes</b>	Does not auto return.
<b>Dependencies</b>	The reference level limits are determined in part by the External Gain/Atten, Max Mixer Level, and RF Atten. This key is grayed out in Modes that do not support External Gain
<b>Preset</b>	This is unaffected by Preset but is set to 0 dB on a "Restore Input/Output Defaults" or "Restore System Defaults->All"
<b>State Saved</b>	Saved in instrument state
<b>Min</b>	-120 dB
<b>Max</b>	120 dB
<b>Readback</b>	Preamp Gain, <Ext Gain value> dB
<b>Backwards Compatibility SCPI</b>	<code>[ :SENSe ] :CORRection:OFFSet[:MAGNitude]</code> The legacy "Ext Preamp Gain" key is now called "Ext Gain" and the sub-menu has choices of Ext Preamp   MS   BTS for backwards compatibility.
<b>Initial S/W Revision</b>	Prior to A.02.00
<b>Modified at S/W Revision</b>	A.14.00

## More Information

The U7227A USB Preamplifier is an accessory for the X-Series Signal Analyzer that provides gain externally, and whose gain settings are automatically loaded into the analyzer over USB whenever it is connected to one of the analyzer's USB ports.

While the USB Preamplifier is plugged into one of the analyzer's USB ports, the analyzer will consider it to be in the signal path of the RF Input and will apply the calibration data from the USB Preamp to measurements taken at the RF Input (on 2 input boxes, it will be considered to be in the signal path of RF Input 1; it is not supported for RF Input 2).

The USB Preamplifier contains its own cal data. This includes a noise trace suitable for use with NFE, for those models which support NFE. The act of connecting the Preamp to USB will cause the cal data to be downloaded from the preamp. When this happens an informational message is provided saying "Cal data loaded from USB Preamp". The analyzer will then automatically apply the calibration factors loaded from the Preamp in any measurement that supports the USB Preamp.

The External Preamp Gain setting may still be used, even though it is not required for the USB Preamp (since the USB Preamp supplies its own gain data to the analyzer which is applied automatically). Connecting the USB Preamp does not change the External Preamp Gain setting, however unless you have another gain or attenuation element in the signal path, the appropriate setting for External Preamp Gain is 0 dB.

Overload detection and reporting will apply when the USB preamplifier is connected to USB. The USB Preamplifier has its own overload detector which reports overloads to the instrument over USB. This generates an error condition, "Input Overload;USB Preamp."

If, while the USB Preamp is connected to USB, a measurement is selected that does not support the USB preamplifier, the "No result; Meas invalid with Preamp" error condition is generated.

## MS

Sets an external gain/attenuation value for MS (Mobile Station) tests.

Key Path	Input/Output, External Gain
Remote Command	<code>[ :SENSe]:CORRection:MS[:RF]:GAIN &lt;rel_ampl&gt;</code> <code>[ :SENSe]:CORRection:MS[:RF]:GAIN?</code>
Example	<code>CORR:MS:GAIN 10</code> sets the Ext Gain value to 10 dB <code>CORR:MS:GAIN -10</code> sets the Ext Gain value to -10 dB (that is, a loss of 10 dB.)
Notes	Does not auto return.
Dependencies	The reference level limits are determined in part by the External Gain, Max Mixer Level, RF Atten This key is grayed out in modes that do not support MS.
Preset	This is unaffected by a Preset but is set to 0 dB on a "Restore Input/Output Defaults" or "Restore System Defaults->All"
State Saved	Saved in instrument state.
Min	-100 dB
Max	100 dB
Readback	MS, <Ext Gain value> dB
Initial S/W Revision	Prior to A.02.00

Remote Command	<code>[ :SENSe]:CORRection:MS[:RF]:LOSS &lt;rel_ampl&gt;</code> <code>[ :SENSe]:CORRection:MS[:RF]:LOSS?</code>
Example	<code>CORR:MS:LOSS 10</code> sets the Ext Gain value to -10 dB, and subsequently querying <code>:LOSS</code> will give 10 dB <code>CORR:MS:LOSS -10</code> sets the Ext Gain value to 10 dB, and subsequently querying <code>:LOSS</code> will give -10 dB
Notes	A positive value of <rel_ampl> in the above command means a loss and a negative value indicates a gain. Anytime <code>:LOSS</code> is set it sets <code>:GAIN</code> to the negative value of the parameter sent. Anytime <code>:LOSS</code> is queried it gives the negative of <code>:GAIN</code>
Preset	This is unaffected by a Preset but is set to 0 dB on a "Restore Input/Output Defaults" or "Restore System Defaults->All"
Min	100 dB
Max	-100 dB
Initial S/W Revision	Prior to A.02.00

## BTS

Sets an external attenuation value for BTS (Base Transceiver Station) tests.

Key Path	Input/Output, External Gain
Remote Command	<code>[ :SENSe]:CORRection:BTS[:RF]:GAIN &lt;rel_ampl&gt;</code> <code>[ :SENSe]:CORRection:BTS[:RF]:GAIN?</code>
Example	CORR:BTS:GAIN 10 sets the Ext Gain value to 10 dB CORR:BTS:GAIN -10 sets the Ext Gain value to -10 dB (that is, a loss of 10 dB.)
Notes	Does not auto return.
Dependencies	The reference level limits are determined in part by the External Gain, Max Mixer Level, RF Atten This key is grayed out in modes that do not support BTS.
Preset	This is unaffected by a Preset but is set to 0 dB on a "Restore Input/Output Defaults" or "Restore System Defaults->All"
State Saved	Saved in instrument state.
Min	-100 dB
Max	100 dB
Readback	BTS, <Ext Gain value> dB
Initial S/W Revision	Prior to A.02.00

Remote Command	<code>[ :SENSe]:CORRection:BTS[:RF]:LOSS &lt;rel_ampl&gt;</code> <code>[ :SENSe]:CORRection:BTS[:RF]:LOSS?</code>
Example	CORR:BTS:LOSS 10 sets the Ext Gain value to -10 dB, and subsequently querying :LOSS will give 10 dB CORR:BTS:LOSS -10 sets the Ext Gain value to 10 dB, and subsequently querying :LOSS will give -10 dB
Notes	A positive value of <rel_ampl> in the above command means a loss and a negative value indicates a gain. Anytime :LOSS is set it sets :GAIN to the negative value of the parameter sent. Anytime :LOSS is queried it gives the negative of :GAIN
Preset	This is unaffected by a Preset but is set to 0 dB on a "Restore Input/Output Defaults" or "Restore System Defaults->All"
Min	100 dB
Max	-100 dB
Initial S/W Revision	Prior to A.02.00

## I Ext Gain

This function affects the I channel input. However, when Q Gain in I+jQ is set to Same as I Gain, this value is applied to both I and Q channel inputs.

Key Path	Input/Output, External Gain
Remote Command	<code>[[:SENSe]:CORRection:IQ:I:GAIN &lt;rel_ampl&gt;</code> <code>[[:SENSe]:CORRection:IQ:I:GAIN?</code>
Example	Set the I Ext Gain to 10 dB <code>CORR:IQ:I:GAIN 10</code> Set the I Ext Gain to -10 dB (that is, a loss of 10 dB.) <code>CORR:IQ:I:GAIN -10</code>
Dependencies	Not available unless option BBA is installed
Preset	0 dB This is unaffected by a Preset but is set to 0 dB on a "Restore Input/Output Defaults" or "Restore System Defaults->All"
State Saved	Saved in instrument state.
Min	-100 dB
Max	100 dB
Readback Text	I Gain, <I Ext Gain> dB
Initial S/W Revision	Prior to A.02.00

## Q Ext Gain

This function affects the Q channel input.

Key Path	Input/Output, External Gain
Remote Command	<code>[[:SENSe]:CORRection:IQ:Q:GAIN &lt;rel_ampl&gt;</code> <code>[[:SENSe]:CORRection:IQ:Q:GAIN?</code>
Example	Set the Q Ext Gain to 10 dB <code>CORR:IQ:Q:GAIN 10</code> Set the Q Ext Gain to -10 dB (that is, a loss of 10 dB.) <code>CORR:IQ:Q:GAIN -10</code>
Dependencies	Not available unless option BBA is installed.
Preset	0 dB This is unaffected by a Preset but is set to 0 dB on a "Restore Input/Output Defaults" or "Restore System Defaults->All"
State Saved	Saved in instrument state
Min	-100 dB

Max	100 dB
Readback Text	Q Gain, <I Ext Gain> dB
Initial S/W Revision	Prior to A.02.00

## Restore Input/Output Defaults

This selection causes the group of settings and data associated with the Input/Output key to be a reset to their default values. In addition, when a Source is installed, licensed and selected, Restore Input/Output defaults will initiate a Source Preset.

This level of Restore System Defaults does not affect any other system settings or mode settings and does not cause a mode switch. All the features described in this section are reset using this key, including Input Corrections and Data (described in the Corrections section).

Key Path	Input/Output
<b>Example</b>	:SYST:DEF INP presets all the Input/Output variables to their factory default values.
Notes	Refer to the Utility Functions for information about Restore System Defaults and the complete description of the :SYSTem:DEFAult INPut: command.
Initial S/W Revision	Prior to A.02.00

## Corrections

This key accesses the Amplitude Corrections menu.

Amplitude Corrections arrays can be entered, sent over SCPI, or loaded from a file. They allow you to correct the response of the analyzer for various use cases. The X-series supports four separate Corrections arrays, each of which can contain up to 2000 points. They can be turned on and off individually and any or all can be on at the same time.

Trace data is in absolute units and corrections data is in relative units, but we want to be able to display trace data at the same time as corrections data. Therefore we establish a reference line to be used while building or editing a Corrections table. The reference line is halfway up the display and represents 0 dB of correction. It is labeled "0 dB CORREC". It is drawn in blue.

Corrections data is always in dB. Whatever dB value appears in the correction table represents the correction applied to that trace at that frequency. So if a table entry shows 30 dB that means we ADD 30 dB to each trace to correct it before displaying it.

In zero span, where the frequency is always the center frequency of the analyzer, we apply the (interpolated) correction for the center frequency to all points in the trace. In the event where there are two correction amplitudes at the center frequency, we apply the first one in the table.

Note that the corrections are applied as the data is taken; therefore, a trace in View (Update Off) will not be affected by changes made to the corrections table after the trace is put in View.

Key Path	Input/Output, Corrections
----------	---------------------------

Mode	SA, I/Q Analyzer, Phase Noise, VXA, RTSA, EMI Receiver, DVB-T/H, DTMB, DVB-T/H, DTMB, W-CDMA, LTE & LTE-Adv FDD, LTE & LTE-Adv TDD, Sequence Analyzer, BTooth
Dependencies	This key will only appear if you have the proper option installed in your instrument. Amplitude correction may not be available in all modes; if a mode does not support amplitude correction, the Corrections key should be blanked while in that mode. If an application supports corrections but the current measurement does not, then the key should be grayed out in that measurement
Preset	Corrections arrays are reset (deleted) by Restore Input/Output Defaults. They survive shutdown and restarting of the analyzer application, which means they will survive a power cycle.
Initial S/W Revision	A.02.00
Modified at S/W Revision	x.14.50

### Select Correction

Specifies the selected correction. The term "selected correction" is used throughout this document to specify which correction will be affected by the functions.

Key Path	Input/Output, Corrections
Mode	SA, I/Q Analyzer, Phase Noise, VXA, RTSA, EMI Receiver, DVB-T/H, DTMB, DVB-T/H, DTMB, W-CDMA, LTE & LTE-Adv FDD, LTE & LTE-Adv TDD, Sequence Analyzer, BTooth
Notes	The selected correction is remembered even when not in the correction menu.
Preset	Set to Correction 1 by Restore Input/Output Defaults
Readback	Correction 1 Correction 2 Correction 3 Correction 4 Correction 5 Correction 6 Correction 7 Correction 8
Initial S/W Revision	A.02.00
Modified at S/W Revision	x.14.50

### Correction On/Off

Turning the Selected Correction from the OFF state to the ON state allows the values in it to be applied to the data. This state transition also automatically turns on "Apply Corrections" (sets it to ON), otherwise the correction would not take effect.

A new sweep is initiated if an amplitude correction is switched on or off. Note that changing, sending or loading corrections data does NOT directly initiate a sweep, however in general these operations will turn corrections on, which DOES initiate a sweep.

Key Path	Input/Output, Corrections
Remote Command	[ :SENSe ] :CORRection:CSET [ 1 ]   2   . . .   8 [ :STATe ] ON   OFF   1   0 [ :SENSe ] :CORRection:CSET [ 1 ]   2   . . .   8 [ :STATe ] ?



<b>Example</b>	SENS:CORR:CSET1 ON
Dependencies	<p>Changing this from the OFF state to the ON state automatically turns on "Apply Corrections".</p> <p>Only the first correction array (Correction 1) supports antenna units. When this array is turned on, and it contains an Antenna Unit other than "None", the Y Axis Unit of the analyzer is forced to that Antenna Unit. All other Y Axis Unit choices are grayed out.</p> <p>Note that this means that a correction file with an Antenna Unit can only be loaded into the Corrections 1 register. Consequently only for Correction 1 does the dropdown in the Recall dialog include.ant, and if an attempt is made to load a correction file into any other Correction register which DOES contain an antenna unit, a Mass Storage error is generated.</p> <p>This command will generate an "Option not available" error unless you have the proper option installed in your instrument.</p>
Preset	Not affected by a Preset. Set to OFF by Restore Input/Output Defaults
State Saved	Saved in instrument state.
Backwards Compatibility Notes	Unlike legacy analyzers, Preset does not turn Corrections off (Restore Input/Output Defaults does).
Initial S/W Revision	A.02.00
Modified at S/W Revision	A.14.00

## Properties

Accesses a menu that lets you set the properties of the selected correction.

Key Path	Input/Output, Corrections
Initial S/W Revision	A.02.00

## Select Correction

Specifies the selected correction. The term "selected correction" is used throughout this document to specify which correction will be affected by the functions.

Key Path	Input/Output, Corrections
Mode	SA, I/Q Analyzer, Phase Noise, VXA, RTSA, EMI Receiver, DVB-T/H, DTMB, DVB-T/H, DTMB, W-CDMA, LTE & LTE-Adv FDD, LTE & LTE-Adv TDD, Sequence Analyzer, BTooth
Notes	The selected correction is remembered even when not in the correction menu.
Preset	Set to Correction 1 by Restore Input/Output Defaults
Readback	Correction 1 Correction 2 Correction 3 Correction 4 Correction 5 Correction 6 Correction 7 Correction 8
Initial S/W Revision	A.02.00
Modified at S/W Revision	x.14.50

## Antenna Unit

For devices (like antennas) that make measurements of field strength or flux density, the correction array should contain within its values the appropriate conversion factors such that, when the data on the analyzer is presented in dB $\mu$ V, the display is calibrated in the appropriate units. The "Antenna Unit" used for the conversion is contained within the corrections array database. It may be specified or loaded in from an external file or SCPI.

When an array with an Antenna Unit other than "None" is turned on, the Y Axis Unit of the analyzer is forced to that unit. When this array is turned on, and it contains an Antenna Unit other than "None", the Y Axis Unit of the analyzer is forced to that Antenna Unit., and all other Y Axis Unit choices are grayed out.

Antenna Unit does not appear in all Modes that support Corrections. Only the modes listed in the Mode row of the table below support Antenna Units.

<b>Key Path</b>	Input/Output, Corrections, Properties
<b>Mode</b>	SA, I/Q Analyzer, Phase Noise, VXI, RTSA, EMI Receiver, DVB-T/H, DTMB, DVB-T/H, DTMB, W-CDMA, LTE & LTE-Adv FDD, LTE & LTE-Adv TDD, Sequence Analyzer, BTooth
<b>Remote Command</b>	[ :SENSE ] :CORRection:CSET [ 1 ] :ANTenna [ :UNIT ] GAUSS   PTES1a   UVM   UAM   UA   NOConversion  [ :SENSE ] :CORRection:CSET [ 1 ] :ANTenna [ :UNIT ] ?
<b>Example</b>	CORR:CSET:ANT GAUS
<b>Dependencies</b>	Only the first correction array (Correction 1) supports antenna units. Note that this means that a correction file with an Antenna Unit can only be loaded into the Corrections 1 register. Consequently only for Correction 1 does the dropdown in the Recall dialog include.ant, and if an attempt is made to load a correction file into any other Correction register which DOES contain an antenna unit, a Mass Storage error is generated.
<b>Preset</b>	Unaffected by Preset. Set to NOC by Restore Input/Output Defaults
<b>State Saved</b>	Saved in instrument state
<b>Initial S/W Revision</b>	A.02.00
<b>Modified at S/W Revision</b>	x.14.50

## None

Selects no antenna unit for this Correction set. Thus no Y Axis unit will be forced.

<b>Key Path</b>	Input/Output, Corrections, Properties, Antenna Unit
<b>Example</b>	:CORR:CSET:ANT NOC
<b>Readback</b>	"None"
<b>Initial S/W Revision</b>	A.02.00

## dB $\mu$ V/m

Sets the antenna unit to dB $\mu$ V/m. If this correction is turned on, and Apply Corrections is on, the Y Axis Unit will then be forced to dB $\mu$ V/m and all other Y Axis Unit selections will be grayed out.

Key Path	Input/Output, Corrections, Properties, Antenna Unit
<b>Example</b>	:CORR:CSET:ANT UVM
Readback	"dB $\mu$ V/m"
Initial S/W Revision	A.02.00

### dB $\mu$ A/m

Sets the antenna unit to dB $\mu$ A/m. If this correction is turned on, and Apply Corrections is on, the Y Axis Unit will then be forced to dB $\mu$ A/m and all other Y Axis Unit selections will be grayed out.

Key Path	Input/Output, Corrections, Properties, Antenna Unit
<b>Example</b>	:CORR:CSET:ANT UVA
Readback	" dB $\mu$ A/m"
Initial S/W Revision	A.02.00

### dBpT

Sets the antenna unit to dBpT. If this correction is turned on, and Apply Corrections is on, the Y Axis Unit will then be forced to dBpT and all other Y Axis Unit selections will be grayed out.

Key Path	Input/Output, Corrections, Properties, Antenna Unit
<b>Example</b>	:CORR:CSET:ANT PTES
Readback	"dBpT"
Initial S/W Revision	A.02.00

### dBG

Sets the antenna unit to dBG. If this correction is turned on, and Apply Corrections is on, the Y Axis Unit will then be forced to dBG and all other Y Axis Unit selections will be grayed out.

Key Path	Input/Output, Corrections, Properties, Antenna Unit
<b>Example</b>	:CORR:CSET:ANT GAUS
Readback	" dBG"
Initial S/W Revision	A.02.00

### dB $\mu$ A

Sets the antenna unit to dB $\mu$ A. If this correction is turned on, and Apply Corrections is on, the Y Axis Unit will then be forced to dB $\mu$ A and all other Y Axis Unit selections will be grayed out.

Key Path	Input/Output, Corrections, Properties, Antenna Unit
<b>Example</b>	:CORR:CSET:ANT UA
Readback	" dBμA"
Initial S/W Revision	A.11.00

### Frequency Interpolation

This setting controls how the correction values per-bucket are calculated. We interpolate between frequencies in either the logarithmic or linear scale.

This setting is handled and stored individually per correction set.

See ["Interpolation" on page 188](#)

Key Path	Input/Output, Corrections, Properties
<b>Remote Command</b>	[ :SENSe ] :CORRection:CSET [ 1 ]   2   ...   8 :X:SPACing LINear   LOGarithmic [ :SENSe ] :CORRection:CSET [ 1 ]   2   ...   8 :X:SPACing?
<b>Example</b>	CORR:CSET:X:SPAC LIN
Preset	Unaffected by a Preset. Set to Linear by Restore Input/Output Defaults.
State Saved	Saved in instrument state.
Initial S/W Revision	A.02.00
Modified at S/W Revision	A.14.00

### Interpolation

For each bucket processed by the application, all of the correction factors at the frequency of interest (center frequency of each bucket) are summed and added to the amplitude. All trace operations and post processing treat this post-summation value as the true signal to use.

To effect this correction, the goal, for any particular start and stop frequency, is to build a correction trace, whose number of points matches the current Sweep Points setting of the instrument, which will be used to apply corrections on a bucket by bucket basis to the data traces.

For amplitudes that lie between two user specified frequency points, we interpolate to determine the amplitude value. You may select either linear or logarithmic interpolation between the frequencies.

If we interpolate on a log scale, we assume that the line between the two points is a straight line on the log scale. For example, let's say the two points are (2,4) and (20,1). A straight line between them on a log scale looks like:

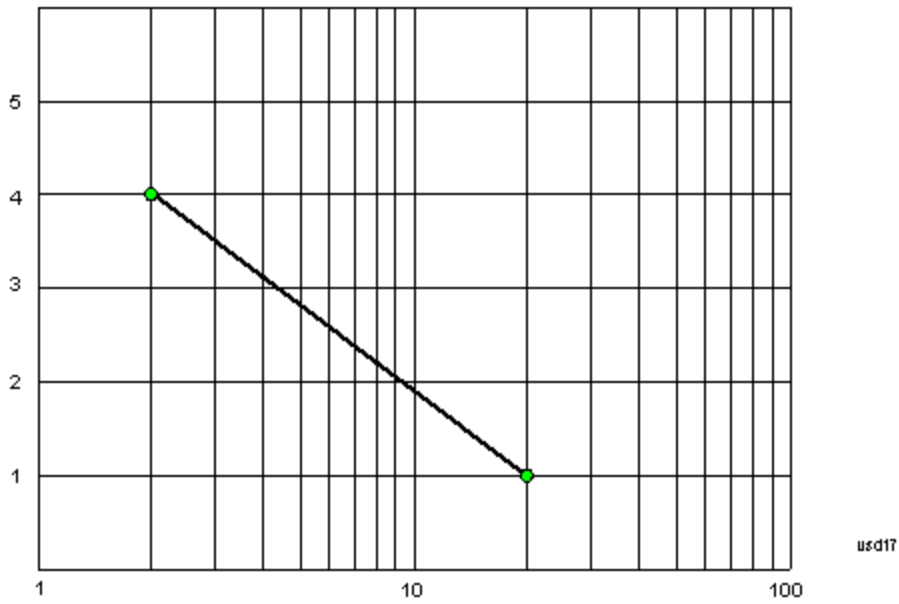

On a linear scale (like that of the spectrum analyzer), this translates to:



If we interpolate on a linear scale, we assume that the two points are connected by a straight line on the linear scale, as below:

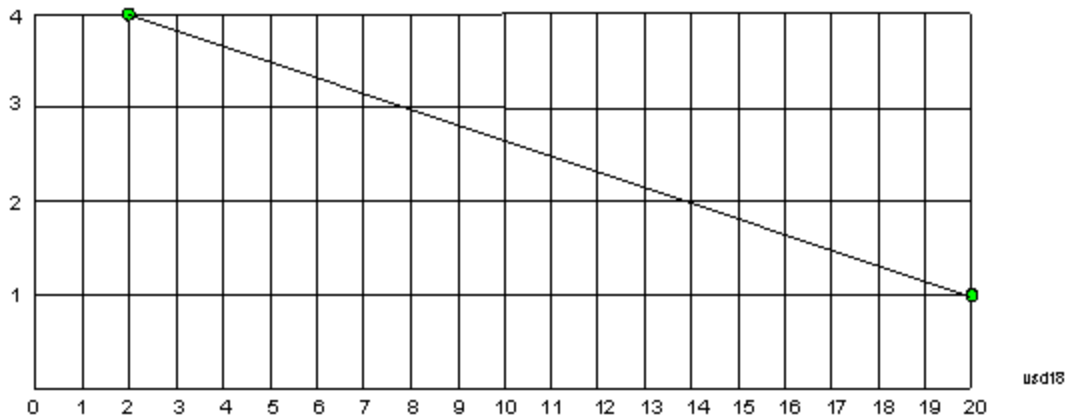

The correction to be used for each bucket is taken from the interpolated correction curve at the center of the bucket.

### Description

Sets an ASCII description field which will be stored in an exported file. Can be displayed in the active function area by selecting as the active function, if desired to appear in a screen capture.

<b>Key Path</b>	Input/Output, Corrections, Properties
<b>Remote Command</b>	[[:SENSe]:CORRection:CSET[1] 2 ... 8:DESCRiption "text" [:SENSe]:CORRection:CSET[1] 2 ... 8:DESCRiption?
<b>Example</b>	:CORR:CSET1:DESC "11941A Antenna correction"
<b>Notes</b>	45 chars max; may not fit on display if max chars used
<b>Preset</b>	Unaffected by a Preset. Set to empty by Restore Input/Output Defaults
<b>State Saved</b>	Saved in instrument state.
<b>Initial S/W Revision</b>	A.02.00
<b>Modified at S/W Revision</b>	A.14.00

### Comment

Sets an ASCII comment field which will be stored in an exported file. Can be displayed in the active function area by selecting as the active function, if desired to appear in a screen capture.

<b>Key Path</b>	Input/Output, Corrections, Properties
<b>Remote Command</b>	[[:SENSe]:CORRection:CSET[1] 2 ... 8:COMMent "text" [:SENSe]:CORRection:CSET[1] 2 ... 8:COMMent?
<b>Example</b>	:CORR:CSET1:COMM "this is a comment"
<b>Notes</b>	60 chars max; may not fit on display if max chars used
<b>Preset</b>	Unaffected by Preset. Set to empty by Restore Input/Output Defaults
<b>State Saved</b>	Saved in instrument state
<b>Initial S/W Revision</b>	A.02.00
<b>Modified at S/W Revision</b>	A.14.00

### Edit

Invokes the integrated editing facility for this correction set.

When entering the menu, the editor window turns on, the selected correction is turned On, Apply Corrections is set to On, the amplitude scale is set to Log, and the Amplitude Correction ("Ampcor") trace is displayed. The actual, interpolated correction trace is shown in green for the selected correction. Note that since the actual interpolated correction is shown, the correction trace may have some curvature to it. This trace represents only the correction currently being edited, rather than the total, accumulated amplitude

correction for all amplitude corrections which are currently on, although the total, accumulated correction for all corrections which are turned on is still applied to the data traces.

Because corrections data is always in dB, but the Y-axis of the analyzer is in absolute units, it is necessary to establish a reference line for display of the Corrections data. The reference line is halfway up the display and represents 0 dB of correction. It is labeled "0 dB CORREC". It is drawn in blue.

Corrections data is always in dB. Whatever dB value appears in the correction table represents the correction to be applied to that trace at that frequency. So if a table entry shows 30 dB that means we ADD 30 dB to each trace to correct it before displaying it. By definition all points are connected. If a gap is desired for corrections data, enter 0 dB.

Note that a well-designed Corrections array should start at 0 dB and end at 0 dB. This is because whatever the high end point is will be extended to the top frequency of the instrument, and whatever the low end point is will be extended down to 0 Hz. So for a Corrections array to have no effect outside its range, you should start and end the array at 0 dB.

**NOTE** The table editor will only operate properly if the analyzer is sweeping, because its updates are tied to the sweep system. Thus, you should not try to use the editor in single sweep, and it will be sluggish during compute-intensive operations like narrow-span FFT sweeps.

When exiting the edit menu (by using the Return key or by pressing an instrument front-panel key), the editor window turns off and the Ampcor trace is no longer displayed; however, Apply Corrections remains On, any correction that was on while in the editor remains on, and the amplitude scale returns to its previous setting.

Corrections arrays are not affected by a Preset, because they are in the Input/Output system. They also survive shutdown and restarting of the analyzer application, which means they will survive a power cycle.

When editing a correction, the editor remembers which correction and which element in the correction array you were editing, and returns you to that correction and that element when you return to the editor after leaving it.

Key Path	Input/Output, Corrections
Initial S/W Revision	A.02.00

## Navigate

Lets you move through the table to edit the desired point.

Key Path	Input/Output, Corrections, Edit
Notes	There is no value readback on the key
Min	1
Max	2000
Initial S/W Revision	A.02.00

### Frequency

Lets you edit the frequency of the current row.

Key Path	Input/Output, Corrections, Edit
Notes	There is no value readback on the key.
Min	0
Max	1 THz
Initial S/W Revision	A.02.00

### Amplitude

Lets you edit the Amplitude of the current row.

Key Path	Input/Output, Corrections, Edit
Notes	There is no value readback on the key.
Min	-1000 dB
Max	1000 dB
Initial S/W Revision	A.02.00

### Insert Point Below

Inserts a point below the current point. The new point is a copy of the current point and becomes the current point. The new point is not yet entered into the underlying table, and the data in the row is displayed in light gray.

Key Path	Input/Output, Corrections, Edit
Initial S/W Revision	A.02.00

### Delete Point

Deletes the currently-selected point, whether or not that point is being edited, and selects the Navigate functionality. The point following the currently-selected point (or the point preceding if there is none) will be selected.

Key Path	Input/Output, Corrections, Edit
Initial S/W Revision	A.02.00

### Delete Correction

Deletes the correction values for this set. When this key is pressed a prompt is placed on the screen that says "Please press Enter or OK key to delete correction. Press ESC or Cancel to close this dialog." The



deletion is only performed if you press OK or Enter.

Key Path	Input/Output, Corrections
<b>Remote Command</b>	<code>[ :SENSe] :CORRection:CSET[1] 2 ... 6:DELeTe</code>
<b>Example</b>	CORR:CSET:DEL CORR:CSET1:DEL CORR:CSET4:DEL
Notes	Pressing this key when no corrections are present is accepted without error.
Initial S/W Revision	A.02.00

## Apply Corrections

Applies amplitude corrections, which are marked as ON to the measured data. If this is set to OFF, then no amplitude correction sets will be used, regardless of their individual on/off settings. If set to ON, the corrections that are marked as ON (see "[Correction On/Off](#)" on page 184) are used.

Key Path	Input/Output, Corrections
<b>Remote Command</b>	<code>[ :SENSe] :CORRection:CSET:ALL[:STATe] ON OFF 1 0</code> <code>[ :SENSe] :CORRection:CSET:ALL[:STATe] ?</code>
<b>Example</b>	SENS:CORR:CSET:ALL OFF This command makes sure that no amplitude corrections are applied, regardless of their individual on/off settings.
Preset	Not affected by Preset. Set to OFF by Restore Input/Output Defaults
State Saved	Saved in instrument state.
Initial S/W Revision	A.02.00

## Delete All Corrections

Erases all correction values for all 4 Amplitude Correction sets.

When this key is pressed a prompt is placed on the screen that says "Please press Enter or OK key to delete all corrections. Press ESC or Cancel to close this dialog." The deletion is only performed if you press OK or Enter.

Key Path	Input/Output, Corrections
<b>Remote Command</b>	<code>[ :SENSe] :CORRection:CSET:ALL:DELeTe</code>
<b>Example</b>	CORR:CSET:ALL:DEL
Initial S/W Revision	A.02.00

## Remote Correction Data Set Commands

This section describes the remote (SCPI) commands used to put values into correction sets. See the correction / table editor section of the Input/Output section for the information on front panel entry of correction data.

"Set (Replace) Data (Remote Command Only)" on page 194

"Merge Correction Data (Remote Command Only)" on page 194

### Set (Replace) Data (Remote Command Only)

The command takes an ASCII series of alternating frequency and amplitude points, each value separated by commas.

The values sent in the command will totally replace all existing correction points in the specified set.

An Ampcor array can contain 2000 points maximum.

<b>Remote Command</b>	<code>[[:SENSe]:CORRection:CSET[1] 2 ... 8:DATA &lt;freq&gt;, &lt;ampl&gt;, . . .</code> <code>[[:SENSe]:CORRection:CSET[1] 2 ... 8:DATA?</code>
<b>Example</b>	<code>CORR:CSET1:DATA 10000000, -1.0, 20000000, 1.0</code> This defines two correction points at (10 MHz, -1.0 dB) and (20 MHz, 1.0 dB) for correction set 1.
<b>Preset</b>	Empty after Restore Input/Output Defaults. Survives a shutdown or restart of analyzer application (including a power cycle).
<b>State Saved</b>	Saved in instrument state.
<b>Min</b>	Freq: 0 Hz Amptd: -1000 dBm
<b>Max</b>	Freq: 1 THz Amptd: +1000 dBm
<b>Initial S/W Revision</b>	A.02.00
<b>Modified at S/W Revision</b>	A.14.00

### Merge Correction Data (Remote Command Only)

The command takes an ASCII series of alternating frequency and amplitude points, each value separated by commas. The difference between this command and Set Data is that this merges new correction points into an existing set.

Any new point with the same frequency as an existing correction point will replace the existing point's amplitude with that of the new point.

An Ampcor array can contain 2000 total points, maximum.

<b>Remote Command</b>	<code>[[:SENSe]:CORRection:CSET[1] 2 ... 8:DATA:MERGE &lt;freq&gt;, &lt;ampl&gt;, ...</code>
<b>Example</b>	<code>CORR:CSET1:DATA:MERGE 15000000, -5.0, 25000000, 5.0</code> This adds two correction points at (15 MHz, -5.0 dB) and (25 MHz, 5.0 dB) to whatever values already exist in correction set 1.

Preset	Empty after Restore Input/Output Defaults. Survives shutdown/restart of analyzer application (including power cycle)
Min	Freq: 0 Hz Amptd: -1000 dBm
Max	Freq: 1 THz Amptd: +1000 dBm
Initial S/W Revision	A.02.00
Modified at S/W Revision	A.14.00

## Freq Ref In

Specifies the frequency reference as being the internal reference at the rear panel input labeled EXT REF IN, a 1 pulse per second signal at the EXT REF IN input, external reference or sensing the presence of a signal at the EXT REF IN input.

When the frequency reference is set to internal, the internal 10 MHz reference is used even if an external reference is connected.

When the frequency reference is set to external, the instrument will use the external reference. However, if there is no external signal present, or it is not within the proper amplitude range, a condition error message is generated. When the external signal becomes valid, the error is cleared.

When the frequency reference is set to Pulse, the instrument expects a 1 pulse per second signal at the EXT REF IN input. The instrument uses this signal to adjust the frequency of the internal reference.

If Sense is selected, the instrument checks whether a signal is present at the external reference connector. If it senses a signal within 5 ppm of the External Ref Freq (as set on the External Ref Freq softkey), it will automatically switch to the external reference. If it senses a 1 pulse per second signal, it enters Pulse mode, wherein the signal is used to adjust the internal reference. When no signal is present, it automatically switches to the internal reference. No message is generated as the reference switches between pulse, external and internal. The monitoring of the external reference occurs approximately on 1 millisecond intervals, and never occurs in the middle of a measurement acquisition, only at the end of the measurement (end of the request).

If for any reason the instrument's frequency reference is not able to obtain lock, Status bit 1 in the Questionable Frequency register will be true and a condition error message is generated. When lock is regained, Status bit 1 in the Questionable Frequency register will be cleared and the condition error will be cleared.

If an external frequency reference is being used, you must enter the frequency of the external reference if it is not exactly 10 MHz. The External Ref Freq key is provided for this purpose.

Key Path	Input/Output
<b>Remote Command</b>	[ :SENSe ] :ROSCillator :SOURCE :TYPE INTernal   EXTernal   SENSE   PULSE [ :SENSe ] :ROSCillator :SOURCE :TYPE ?
<b>Dependencies</b>	The PULSE parameter, and support of the 1 pps signal at the EXT REF IN input, are not available in firmware prior to A.13.00. They are also not available in some model numbers. If not available, the

	Pulse key will be blank, and sending the PULSe parameter via SCPI will generate an error:
Preset	This is unaffected by a Preset but is set to SENSE on a "Restore Input/Output Defaults" or "Restore System Defaults->All".
State Saved	Saved in instrument state.
Status Bits/OPC dependencies	STATus:QUESTIONable:FREQuency bit 1 set if unlocked.
Backwards Compatibility Notes	Freq Ref In was not saved in state in the legacy instruments. It is a part of state in the X-Series.
Initial S/W Revision	Prior to A.02.00
Modified at S/W Revision	A.14.00

<b>Remote Command</b>	<code>[[:SENSe]:ROSCillator:SOURce?</code>
Notes	<p>The query <code>[SENSe]:ROSCillator:SOURce?</code> returns the current switch setting. This means:</p> <ol style="list-style-type: none"> <li>1. If it was set to SENSE but there is no external reference nor 1 pps signal so the instrument is actually using the internal reference, then this query returns INTERNAL and not SENSE.</li> <li>2. If it was set to SENSE and there is an external reference present, the query returns EXTERNAL and not SENSE.</li> <li>3. If it was set to SENSE and there is a 1 pps signal present, the query returns PULSe and not SENSE.</li> <li>4. If it was set to EXTERNAL, then the query returns "EXTERNAL"</li> <li>5. If it was set to INTERNAL, then the query returns "INTERNAL".</li> <li>6. If it was set to PULSe, then the query returns "PULSe"</li> </ol>
Preset	SENSe
Backwards Compatibility Notes	<p>The query <code>[[:SENSe]:ROSCillator:SOURce?</code> was a query-only command in ESA which always returned whichever reference the instrument was using. The instrument automatically switched to the ext ref if it was present.</p> <p>In PSA (which had no sensing) the command <code>[[:SENSe]:ROSCillator:SOURce</code> set the reference (INT or EXT), so again its query returned the actual routing.</p> <p>Thus the query form of this command is 100% backwards compatible with both instruments.</p>
Initial S/W Revision	Prior to A.02.00

<b>Remote Command</b>	<code>[[:SENSe]:ROSCillator:SOURce INTernal EXTernal</code>
Notes	For PSA compatibility the command form is provided and is directly mapped to <code>[[:SENSe]:ROSCillator:SOURce:TYPE</code>
Initial S/W Revision	Prior to A.02.00

## Sense

If Sense is selected, the instrument checks whether a signal is present at the external reference connector. If it senses a signal within 5 ppm of the External Ref Freq (as set on the External Ref Freq softkey), it will use this signal as an External Reference. If it senses a 1 pulse per second signal, it will use this signal to adjust the internal reference by adjusting the User setting of the Timebase DAC. When no signal is present, it automatically switches to the internal reference.

Key Path	Input/Output, Freq Ref In
<b>Example</b>	:ROSC:SOUR:TYPE SENS
Couplings	If set to SENSE and the analyzer senses a 1 pulse per second signal, it sets the System, Alignments, Timebase DAC setting to "User". This setting survives Preset and Power Cycle but is set to "Calibrated" on a System, Restore Defaults, Align or a System, Restore Defaults, All
Readback	Sense
Initial S/W Revision	Prior to A.02.00
Modified at S/W Revision	A.14.00

## Internal

The internal reference is used. A 1 pps signal at the EXT REF IN port, or a signal there between 1 and 50 MHz, will cause a warning triangle to appear in the settings panel next to the word "INTERNAL", but will otherwise be ignored.

Key Path	Input/Output, Freq Ref In
<b>Example</b>	:ROSC:SOUR:TYPE INT
Readback	Internal
Initial S/W Revision	Prior to A.02.00
Modified at S/W Revision	A.14.00

## External

The external reference is used.

Key Path	Input/Output, Freq Ref In
<b>Example</b>	:ROSC:SOUR:TYPE EXT
Readback	External
Initial S/W Revision	Prior to A.02.00

## Ext Ref Freq

This key tells the analyzer the frequency of the external reference. When the external reference is in use (either because the reference has been switched to External or because the Reference has been switched

to Sense and there is a valid external reference present) this information is used by the analyzer to determine the internal settings needed to lock to that particular external reference signal.

For the instrument to stay locked, the value entered must be within 5 ppm of the actual external reference frequency. So it is important to get it close, or you risk an unlock condition.

Note that this value only affects the instrument's ability to lock. It does not affect any calculations or measurement results. See "Freq Offset" in the Frequency section for information on how to offset frequency values.

<b>Key Path</b>	Input/Output, Freq Ref In
<b>Remote Command</b>	[ :SENSe ] :ROSCillator:EXTernal:FREQuency <freq> [ :SENSe ] :ROSCillator:EXTernal:FREQuency?
<b>Example</b>	ROSC:EXT:FREQ 20 MHz sets the external reference frequency to 20 MHz, but does not select the external reference. ROSC:SOUR:TYPE EXT selects the external reference.
<b>Dependencies</b>	Still available with Internal or Pulse selected, to allow setup for when External is in use. However, the setting has no effect if the Internal Reference is in use (Freq Ref In set to Internal, Pulse, or SENSE:INT or SENSE:PULSE).
<b>Preset</b>	This is unaffected by a Preset but is set to 10 MHz on a "Restore Input/Output Defaults" or "Restore System Defaults->All"
<b>Min</b>	CXA: 10 MHz EXA: 10 MHz MXA: 1 MHz PXA: 1 MHz N8973B, N8974B, N8975B, or N8976B: 10 MHz
<b>Max</b>	CXA: 10 MHz EXA: 10 MHz EXA with option R13: 20 MHz MXA: 50 MHz PXA: 50 MHz N8973B, N8974B, N8975B, or N8976B: 10 MHz
<b>Default Unit</b>	Hz
<b>Initial S/W Revision</b>	Prior to A.02.00
<b>Modified at S/W Revision</b>	A.14.00

## External Reference Lock BW

This control lets you adjust the External Reference phase lock bandwidth. This control is available in some models of the X-Series.

The PXA variable reference loop bandwidth allows an external reference to be used and have the analyzer close-in phase noise improved to match that of the reference. This could result in an improvement of tens of decibels. The choice of “Wide” or “Narrow” affects the phase noise at low offset frequencies, especially 4 to 400 Hz offset. When using an external reference with superior phase noise, we recommend setting the external reference phase-locked-loop bandwidth to wide (60 Hz), to take advantage of that superior performance. When using an external reference with inferior phase noise performance, we recommend setting that bandwidth to narrow (15 Hz). In these relationships, inferior and superior phase noise are with respect to  $-134$  dBc/Hz at 30 Hz offset from a 10 MHz reference. Because most reference sources have phase noise behavior that falls off at a rate of 30 dB/decade, this is usually equivalent to  $-120$  dBc/Hz at 10 Hz offset.

Key Path	Input/Output, Freq Ref In
Scope	Mode Global
Remote Command	<code>[ :SENSe ] :ROSCillator :BANDwidth WIDE   NARRow</code> <code>[ :SENSe ] :ROSCillator :BANDwidth ?</code>
Example	ROSC:BAND WIDE
Dependencies	Still available with Internal or Pulse selected, to allow setup for when External is in use. However, the setting has no effect if the Internal Reference is in use (Freq Ref In set to Internal, Pulse, or SENSE:INT or SENSE:PULSE).  This key only appears in analyzers equipped with the required hardware.
Preset	This is unaffected by a Preset but is set to Narrow on a "Restore Input/Output Defaults" or "Restore System Defaults -> All"
State Saved	Saved in Input/Output state.
Initial S/W Revision	A.04.00
Modified at S/W Revision	A.14.00

## Output Config

Accesses keys that configure various output settings, like the frequency reference output, trigger output and analog output.

Key Path	Input/Output
Backwards Compatibility Notes	In ESA there was not a user interface to enable the Video Output (Analog Output), Trigger Output, or Gate Output. In the X-Series each of these physical connectors requires configuration, thus the user interface has been added for X-Series, along with the potential for an output you think is always on to be switched off.
Initial S/W Revision	Prior to A.02.00

## Trig Out

Select the type of output signal that will be output from the Trig 1 Out, or Trig 2 Out connectors.

<b>Key Path</b>	Input/Output, Output Config
<b>Remote Command</b>	:TRIGger TRIGger1 TRIGger2[:SEquence]:OUTPut HSWP   MEASuring   MAIN   GATE   GTRigger   OEVen   SPOint   SSweep   SSETtled   S1Marker   S2Marker   S3Marker   S4Marker   OFF  :TRIGger TRIGger1 TRIGger2[:SEquence]:OUTPut?
<b>Example</b>	TRIG:OUTP HSWP TRIG2:OUTP GATE
<b>Dependencies</b>	The second Trigger output (Trig 2 Out) does not appear in all models; in models that do not support it, the Trig 2 Out key is blanked, and sending the SCPI command for this output generates an error, "Hardware missing; Not available for this model number" In models that do not support the Trigger 2 output, this error is returned if trying to set Trig 2 Out and a query of Trig 2 Out returns OFF.
<b>Preset</b>	Trigger 1: Sweeping (HSWP) Trigger 2: Gate This is unaffected by a Preset but is preset to the above values on a "Restore Input/Output Defaults" or "Restore System Defaults->All"
<b>State Saved</b>	Saved in instrument state
<b>Initial S/W Revision</b>	Prior to A.02.00

## Polarity

Sets the output to the Trig 1 Out, or Trig 2 Out, connector to trigger on either the positive or negative polarity.

<b>Key Path</b>	Input/Output, Output Config, Trig 1/2 Output
<b>Remote Command</b>	:TRIGger TRIGger1 TRIGger2[:SEquence]:OUTPut:POLarity POSitive   NEGative  :TRIGger TRIGger1 TRIGger2[:SEquence]:OUTPut:POLarity?
<b>Example</b>	TRIG1:OUTP:POL POS
<b>Preset</b>	This is unaffected by a Preset but is set to POSitive on a "Restore Input/Output Defaults" or "Restore System Defaults->All"
<b>State Saved</b>	Saved in instrument state
<b>Initial S/W Revision</b>	Prior to A.02.00

## Off

Selects no signal to be output to the Trig 1 Out, or Trig 2 Out, connector.



Key Path	Input/Output, Output Config, Trig 1/2 Output
<b>Example</b>	TRIG1:OUTP OFF
Readback	Off
Initial S/W Revision	Prior to A.02.00

### Sweeping (HSWP)

Selects the Sweeping Trigger signal to be output to the Trig 1 Out, or Trig 2 Out, connector when a measurement is made. This signal has historically been known as "HSWP" (High = Sweeping), and is 5 V TTL level with 50 ohm output impedance.

Key Path	Input/Output, Output Config, Trig 1/2 Output
<b>Example</b>	TRIG1:OUTP HSWP
Readback	Sweeping
Initial S/W Revision	Prior to A.02.00

### Measuring

Selects the Measuring trigger signal to be output to the Trig 1 Out, or Trig 2 Out, connector. This signal is true while the Measuring status bit is true.

Key Path	Input/Output, Output Config, Trig 1/2 Output
<b>Example</b>	TRIG1:OUTP MEAS
Readback	Measuring
Initial S/W Revision	Prior to A.02.00

### Main Trigger

Selects the current instrument trigger signal to be output to the Trig 1 Out, or Trig 2 Out, connector.

Key Path	Input/Output, Output Config, Trig 1/2 Output
<b>Example</b>	TRIG1:OUTP MAIN
Readback	Main Trigger
Initial S/W Revision	Prior to A.02.00

### Gate Trigger

Selects the gate trigger signal to be output to the Trig 1 Out, or Trig 2 Out, connector. This is the source of the gate timing, not the actual gate signal.

Key Path	Input/Output, Output Config, Trig 1/2 Output
<b>Example</b>	TRIG1:OUTP GTR
Readback	Gate Trigger
Initial S/W Revision	Prior to A.02.00

### Gate

Selects the gate signal to be output to the Trig 1 Out, or Trig 2 Out, connector. The gate signal has been delayed and its length determined by delay and length settings. When the polarity is positive, a high on the Trig 1 Out, or Trig 2 Out, represents the time the gate is configured to pass the signal.

Key Path	Input/Output, Output Config, Trig 1/2 Output
<b>Example</b>	TRIG1:OUTP GATE
Readback	Gate
Initial S/W Revision	Prior to A.02.00

### Source Point Trigger

Selects the gate signal to be output to the Trig 1 Out, or Trig 2 Out, connector for use as the Point Trigger when operating an external source in Tracking mode. When Ext Trigger 1 is selected as the Point Trigger under Source, the Source Point Trigger under Trig1 Out automatically gets selected. Similarly, when Ext Trigger 2 is selected as the Point Trigger under Source, the Source Point Trigger key under Trig 2 Out automatically gets selected

Key Path	Input/Output, Output Config, Trig 1/2 Output
<b>Example</b>	TRIG1:OUTP SPO
Readback	Source Point
Initial S/W Revision	Prior to A.02.00

### Odd/Even Trace Point

Selects either the odd or even trace points as the signal to be output to the Trig 1 Out, or Trig 2 Out, connector when performing swept spectrum analysis. When the polarity is positive, this output goes high during the time the analyzer is sweeping past the first point (Point 0) and every other following trace point. The opposite is true if the polarity is negative.

Key Path	Input/Output, Output Config, Trig 1/2 Output
<b>Example</b>	TRIG1:OUTP OEV
Readback	Odd/Even
Initial S/W Revision	Prior to A.02.00

## Analog Out

This menu lets you control which signal is fed to the “Analog Out” connector on the analyzer rear panel.

See ["More Information" on page 203](#)

Key Path	Input/Output, Output Config
Remote Command	:OUTPut:ANALog OFF   SVIDeo   LOGVideo   LINVideo   DAUDio :OUTPut:ANALog?
Example	OUTP:ANAL SVIDeo ! causes the analog output type to be Screen Video
Preset	This is unaffected by Preset but is set to DAUDio on a "Restore Input/Output Defaults" or "Restore System Defaults->All
Preset	OFF
State Saved	Saved in Input/Output State
Readback line	1-of-N selection [variable]
Backwards Compatibility Notes	Prior to A.04.00, OFF was the default functionality except when in the Analog Demod application or with Tune and Listen, in which case it was DAUDio, and there was no selection menu. So for backwards compatibility with earlier X-Series firmware versions, Auto (:OUTP:ANAL:AUTO ON) will duplicate the prior behavior.  The DNWB and SANalyzer parameters, which were legal in PSA but perform no function in the X-Series, are accepted without error.
Initial S/W Revision	A.04.00

## More Information

The table below gives the range for each output.

Analog Out	Nominal Range exc. (10% overrange)	Scale Factor	Notes
Off	0 V		
Screen Video	0 – 1 V open circuit	10%/division	8566 compatible
Log Video	0 – 1 V terminated	1/(192.66 dB/V)	dB referenced to mixer level, 1V out for -10 dBm at the mixer.
Linear Video	0 – 1 V terminated	100%/V	Linear referenced to Ref Level, 1 V out for RF envelope at the Ref Level.
Demod Audio	(varies with analyzer setting)		

## Auto

Selects the Auto state for the Analog Output menu. In this state, the Analog Output will automatically be set to the most sensible setting for the current mode or measurement.

If you make a selection manually from the Analog Out menu, this selection will remain in force until you change it (or re-select Auto), even if you go to a mode or measurement for which the selected output does not apply.

Key Path	Input/Output, Output Config, Analog Out
Remote Command	OUTPut:ANALog:AUTO OFF ON 0 1 OUTPut:ANALog:AUTO?
Example	OUTP:ANAL:AUTO ON
Preset	ON
State Saved	Saved in Input/Output State
Initial S/W Revision	A.04.00

### Off

Turns off the analog output.

Key Path	Input/Output, Output Config, Analog Out
Example	OUTP:ANAL OFF ! causes the analog output to be off
Readback Text	Off
Initial S/W Revision	A.04.00

### Screen Video

Selects the analog output to be the screen video signal. In this mode, the pre-detector data is output to the Analog Out connector. The output looks very much like the trace displayed on the analyzer's screen, and depends on the Log/Lin display Scale, Reference Level, and dB per division, but is not influenced by the selected detector or any digital flatness corrections or trace post-processing (like Trace Averaging).

Note that this mode is similar to the Analog Output of the HP 8566 family and the Video Out (opt 124) capability of the Agilent PSA analyzer (E444x), although there are differences in the behavior.

Key Path	Input/Output, Output Config, Analog Out
Example	OUTP:ANAL SVID
Dependencies	<p>Because the Screen Video output uses one of the two IF processing channels, only one detector is available while Screen Video is selected. All active traces will change to use the same detector as the selected trace when Screen Video is activated.</p> <p>Screen Video output is not available while any EMI Detector is selected (Quasi Peak, RMS Average or EMI Average), because these detectors use both IF processing channels. Consequently, if the user chooses an EMI Detector, there will be no Screen Video output.</p> <p>The output holds at its last value during an alignment and during a marker count. After a sweep:</p> <ul style="list-style-type: none"> <li>• If a new sweep is to follow (as in Continuous sweep mode), the output holds at its last value during the retrace before the next sweep starts. If the analyzer is in zero-span, there is no retrace, as the analyzer remains tuned to the Center Frequency and does not sweep. Therefore, in zero-span, the output simply remains live between display updates.</li> </ul>

	<ul style="list-style-type: none"> <li>If no new sweep is to follow (as in Single sweep mode), the output remains live, and continues to show the pre-detector data</li> </ul> <p>This function depends on optional capability; the key will be blanked and the command will generate an “Option not available” error unless you have Option YAV or YAS licensed in your instrument.</p>
Couplings	Screen Video output changes while in FFT Sweeps, so for measurements that use exclusively FFT Sweeps, or if the user manually chooses FFT Sweeps, the Screen Video output will look different than it does in swept mode.
Readback Text	Screen Video
Backwards Compatibility Notes	See " <b>Backwards Compatibility:</b> " on page 205, below.
Initial S/W Revision	A.04.00

### Backwards Compatibility:

The Screen Video function is intended to be very similar to the 8566 Video Output and the PSA Option 124. However, unlike the PSA, it is not always on; it must be switched on by the Screen Video key. Also, unlike the PSA, there are certain dependencies (detailed above) – for example, the Quasi Peak Detector is unavailable when Screen Video is on.

Furthermore, the PSA Option 124 hardware was unipolar and its large range was padded to be exactly right for use as a Screen Video output. In the X-Series, the hardware is bipolar and has a wider range to accommodate the other output choices. Therefore, the outputs won't match up exactly and users may have to modify their setup when applying the X-Series in a PSA application.

### Demod Audio

Selects the analog output to be the demodulation of the video signal.

When Demod Audio is selected, the demodulated audio signal appears at this output whenever the Analog Demod application is demodulating a signal or when Analog Demod Tune and Listen is operating in the Swept SA measurement.

When Analog Out is in the Auto state, this output is auto-selected when in the Analog Demod mode or when Analog Demod Tune and Listen is operating in the Swept SA measurement.

If any other Analog Output is manually selected when in the Analog Demod mode or when Analog Demod Tune and Listen is operating in the Swept SA measurement, a condition warning message appears.

Key Path	Input/Output, Output Config, Analog Out
Example	OUTP:ANAL DAUD
Dependencies	<p>This key only appears if the Analog Demod application (N9063A), the N6141A or W6141A application, or Option EMC is installed and licensed, otherwise the key will be blanked and the command will generate an “Option not available” error.</p> <p>The output holds at its last value during an alignment and during a marker count. It is not held between sweeps, in order for Tune and Listen to work properly.</p> <p>When Demod Audio is the selected Analog Output:</p> <ul style="list-style-type: none"> <li>all active traces are forced to use the same detector.</li> </ul>

	• CISPR detectors (QPD, EMI Avg, RMS Avg) are unavailable
Readback Text	Demod Audio
Initial S/W Revision	Prior to A.02.00 (this was the default functionality, and there was no selection)
Modified at S/W Revision	A.04.00

## Digital Bus

This menu allows you to configure the LVDS connector located on the rear panel of the instrument. It is a unidirectional link of real time data at a 90 MSa/s rate. The ADC is sampling a 22.5 MHz IF.

The data that appears on this port is raw, uncorrected ADC samples, unless you have option RTL. With option RTL, you get fully corrected I/Q data.

This connector will only be active when the Narrowband IF Path is currently in use.

Key Path	Input/Output, Output Config
Initial S/W Revision	A.04.00

## Bus Out On/Off

When Bus Out is on, all acquisitions are streamed to the output port including acquisitions for internal purposes such as Alignment. The internal processing and routing of acquisitions continues as usual and is unaffected by the state of Bus Out.

When Bus Out is off, no signal appears on the LVDS port.

Key Path	Input/Output, Output Config, Digital Bus
Scope	Mode Global
Remote Command	:OUTPut:DBUS[1][:STATE] ON OFF 1 0 :OUTPut:DBUS[1][:STATE]?
Example	OUTP:DBUS ON
Preset	This is unaffected by a Preset but is set to Off on a "Restore Input/Output Defaults" or "Restore System Defaults -> All"
State Saved	Saved in Input/Output State
Initial S/W Revision	Prior to A.02.00
Modified at S/W Revision	A.04.00

## I/Q Cal Out

The Baseband I/Q "Cal Out" port can be turned on with either a 1 kHz or a 250 kHz square wave. This can be turned on independent of the input selection. A Preset will reset this to Off.

Key Path	Input/Output, Output Config
Remote Command	:OUTPut:IQ:OUTPut IQ1 IQ250 OFF :OUTPut:IQ:OUTPut?
Example	OUTP:IQ:OUTP IQ1
Couplings	An I/Q Cable Calibration or an I/Q Probe Calibration will change the state of the Cal Out port as needed by the calibration routine. When the calibration is finished the I/Q Cal Out is restored to the pre-calibration state.
Preset	Off
State Saved	Saved in instrument state
Range	1 kHz Square Wave 250 kHz Square Wave Off
Readback Text	1 kHz 250 kHz Off
Initial S/W Revision	Prior to A.02.00

## Aux IF Out

This menu controls the signals that appear on the SMA output on the rear panel labeled “AUX IF OUT

The Aux IF Out functionality is only valid for RF and External Mixer inputs. When using the External Mixing path, the Aux IF Out levels (for all three Options CR3, CRP, and ALV) will be uncalibrated because the factory default Aux IF level was set to accommodate the expected IF levels for the RF path.

Key Path	Input/Output, Output Config
Remote Command	:OUTPut:AUX SIF AIF LOGVideo OFF :OUTPut:AUX?
Dependencies	The softkey does not appear in models that do not support the Aux IF Out.
Preset	This is unaffected by a Preset but is set to OFF on a "Restore Input/Output Defaults" or "Restore System Defaults->All"
State Saved	Saved in Input/Output state
Readback line	1-of-N selection [variable]
Backwards Compatibility Notes	In the PSA, the IF output has functionality equivalent to the "Second IF" function in the X-Series' Aux IF Out menu. In the X-Series, it is necessary to switch the Aux IF Out to “Second IF” to get this functionality, whereas in PSA it is always on, since there are no other choices. Hence a command to switch this function to “Second IF” will have to be added by customers migrating from PSA who use the IF Output in PSA.
Initial S/W Revision	A.04.00

## Off

In this mode nothing comes out of the “AUX IF OUT” connector on the rear panel. The connector appears as an open-circuit (that is, it is not terminated in any way).

Key Path	Input/Output, Output Config, Aux IF Out
<b>Example</b>	OUTP:AUX OFF causes the aux output type to be off
Readback Text	Off
Initial S/W Revision	A.04.00

### Second IF

In this mode the 2nd IF output is routed to the rear panel connector. The annotation on the key shows the current 2nd IF frequency in use in the analyzer.

The frequency of the 2nd IF depends on the current IF signal path as shown in the table below:

IF Path Selected	Frequency of "Second IF" Output
10 MHz	322.5 MHz
25 MHz	322.5 MHz
40 MHz	250 MHz
140 MHz	300 MHz

The signal quality, such as signal to noise ratio and phase noise, are excellent in this mode.

Key Path	Input/Output, Output Config, Aux IF Out
<b>Example</b>	OUTP:AUX SIF causes the aux output type to be Second IF
Dependencies	Does not appear unless Option CR3 is installed.
Readback Text	Second IF
Initial S/W Revision	A.04.00

### I/Q Guided Calibration

Calibrating the Baseband I/Q ports requires several steps and manual connections. The Guided Calibration will interactively step you through the required steps, displaying diagrams to help with the connections. The steps will vary depending on the setup.

In the Guided Calibration windows, the date and time of the last calibration are displayed. If any of the items listed are displayed in yellow, this indicates that the calibration for that item is inconsistent with the latest calibration, and you should complete the entire calibration process before you exit the calibration.

### I/Q Isolation Calibration

The I/Q Isolation Calibration must be run before calibrating any port with either the I/Q Cable Calibration or I/Q Probe Calibration. This calibration is performed with nothing connected to any of the front panel I/Q



ports. This is the first step in both the I/Q Cable Calibration and the I/Q Probe Calibration.

### Next

Perform the I/Q Isolation calibration.

Key Path	Input/Output, I/Q, I/Q Cable Calibration
<b>Remote Command</b>	:CALibration:IQ:ISOLation
<b>Example</b>	CAL:IQ:ISOL
Notes	All front panel I/Q ports must not be connected to anything.
Notes	All cables and probes should be disconnected from the I/Q ports before issuing the SCPI command.
State Saved	No.
Initial S/W Revision	Prior to A.02.00

### Exit

Exits the calibration procedure. All ports calibrated before pressing Exit will use the newly acquired calibration data.

Key Path	Input/Output, I/Q, I/Q Cable Calibration
Notes	Using the Exit button will not restore the calibration data to the state prior to entering the guided calibration. Once a port is calibrated the data is stored immediately and the only way to change it is to redo the calibration step.  When the calibration may be left in an inconsistent state, a confirmation dialog will be displayed (see <a href="#">"Exit Confirmation" on page 220</a> ).
Initial S/W Revision	Prior to A.02.00

### I/Q Isolation Calibration Time (Remote Command Only)

Returns the last date and time that the I/Q Isolation Calibration was performed. This is a remote query command only.

<b>Remote Command</b>	:CALibration:IQ:ISOLation:TIME?
<b>Example</b>	:CAL:IQ:ISOL:TIME?
Notes	This returns 6 integer values: year, month, day, hour, minute, second. When no calibration has been performed, all values will be 0.
Initial S/W Revision	A.02.00

### I/Q Cable Calibrate...

The I/Q cable calibration creates correction data for each of the front panel I/Q ports. This calibration data is used whenever no probe specific calibration data is available. It is important that all ports are calibrated using the same short BNC cable so that the data is comparable from port to port.

The guided calibration (front panel only) will show connection diagrams and guide you through the isolation calibration and calibrating each port. The calibration data for each port is stored separately, so as soon as a port is calibrated that data is saved and will be used. If you press "Exit" to exit the calibration process, the data for the ports already completed will still be used. It is recommended that a calibration be completed once started, or if exited, that it be properly done before the next use of the I/Q ports. The "Next" button will perform the calibration for the current port and then proceed to the next step in the calibration procedure. The "Back" button will return to the prior port in the procedure. Both keys and dialog buttons are supplied for ease of use. The dialog buttons are for mouse use and the softkeys for front panel use.

The calibration can also be done via SCPI, but no connection diagrams will be shown. You will have to make the correct connections before issuing each port calibration command. Again, it is recommended that all ports be calibrated at the same time.

The instrument state remains as it was prior to entering the calibration procedure except while a port is actually being calibrated. Once a port is calibrated it returns to the prior state. A port calibration is in process only from the time the "Next" button is pressed until the next screen is shown. For SCPI, this corresponds to the time from issuing the CAL:IQ:FLAT:|B|Q|QB command until the operation is complete.

For example, if the prior instrument state is Cal Out = Off, Input = I+jQ, and Differential = Off, then up until the time the "Next" button is pressed the I Input and Q Input LEDs are on and the Cal Out, I-bar Input and Q-bar Input LEDs are off. Once the "Next" button is pressed for the I port calibration, only the Cal Out and I Input LEDs will be on and the others will be off. When the screen progresses to the next step ("Next" button again enabled), the prior state is restored and only the I Input and Q Input LEDs are on (Cal Out is off again).

The last calibration date and time for each port will be displayed. Any calibrations that are more than a day older than the most recent calibration will be displayed with the color amber.

Key Path	Input/Output, I/Q
Initial S/W Revision	Prior to A.02.00

### I Port

The I port calibration is performed with the front panel's I port connected via a short BNC cable to the Cal Out port. The guided calibration will show a diagram of the required connections.

### Back

Return to the prior step in the calibration procedure.

Key Path	Input/Output, I/Q, Q Setup, Q Probe, Calibrate
Initial S/W Revision	Prior to A.02.00

### Next

Perform the I port calibration.

Key Path	Input/Output, I/Q, I/Q Cable Calibrate...
Remote Command	:CALibration:IQ:FLATness:I

<b>Example</b>	CAL:IQ:FLAT:I
Notes	The recommended procedure is to use the same BNC cable to calibrate all I/Q ports. All I/Q ports should be calibrated sequentially during the procedure. The calibration data is saved as soon as the port is calibrated and will survive power cycles. It is not reset by any preset or restore data commands.
Notes	The I port must be connected to the Cal Out port before issuing the SCPI command.
State Saved	No.
Initial S/W Revision	Prior to A.02.00

### Exit

Exit the calibration procedure. All ports calibrated before pressing Exit will use the newly acquired calibration data.

<b>Key Path</b>	Input/Output, I/Q, I/Q Cable Calibrate...
Notes	Using the Exit button will not restore the calibration data to the state prior to entering the guided calibration. Once a port is calibrated the data is stored immediately and the only way to change it is to redo the calibration step. When the calibration may be left in an inconsistent state, a confirmation dialog will be displayed (see <a href="#">"Exit Confirmation" on page 220</a> ).
Initial S/W Revision	Prior to A.02.00

### I-bar Port

The I-bar port calibration is performed with the front panel's I-bar port connected via a short BNC cable to the Cal Out port. The guided calibration will show a diagram of the required connections.

### Back

Return to the prior step in the calibration procedure.

<b>Key Path</b>	Input/Output, I/Q, I/Q Cable Calibration
Notes	Using the Back button will not restore the calibration data to a prior state. Once a port is calibrated the data is stored immediately and the only way to change it is to redo the calibration step. The Back button allows the user to go back to a prior step to redo that calibration step.
Initial S/W Revision	Prior to A.02.00

### Next

Perform the I-bar port calibration.

<b>Key Path</b>	Input/Output, I/Q, I/Q Cable Calibrate...
-----------------	---

<b>Remote Command</b>	:CALibration:IQ:FLATness:IBAR
<b>Example</b>	CAL:IQ:FLAT:IBAR
<b>Notes</b>	The recommended procedure is to use the same BNC cable to calibrate all I/Q ports. All I/Q ports should be calibrated sequentially during the procedure. The calibration data is saved as soon as the port is calibrated and will survive power cycles. It is not reset by any preset or restore data commands.
<b>Notes</b>	The I-bar port must be connected to the Cal Out port before issuing the SCPI command.
<b>State Saved</b>	No
<b>Initial S/W Revision</b>	Prior to A.02.00

### Exit

Exit the calibration procedure. All ports calibrated before pressing Exit will use the newly acquired calibration data.

<b>Key Path</b>	Input/Output, I/Q, I/Q Cable Calibrate...
<b>Notes</b>	Using the Exit button will not restore the calibration data to the state prior to entering the guided calibration. Once a port is calibrated the data is stored immediately and the only way to change it is to redo the calibration step. When the calibration may be left in an inconsistent state, a confirmation dialog will be displayed (see <a href="#">"Exit Confirmation" on page 220</a> ).
<b>Initial S/W Revision</b>	Prior to A.02.00

### Q Port

The Q port calibration is performed with the front panel's Q port connected via a short BNC cable to the Cal Out port. The guided calibration will show a diagram of the required connections.

### Back

Return to the prior step in the calibration procedure.

<b>Key Path</b>	Input/Output, I/Q, I/Q Cable Calibrate...
<b>Notes</b>	Using the Back button will not restore the calibration data to a prior state. Once a port is calibrated the data is stored immediately and the only way to change it is to redo the calibration step. The Back button allows the user to go back to a prior step to redo that calibration step.
<b>Initial S/W Revision</b>	Prior to A.02.00

### Next

Perform the Q port calibration.

Key Path	Input/Output, I/Q, I/Q Cable Calibrate...
<b>Remote Command</b>	:CALibration:IQ:FLATness:Q
<b>Example</b>	CAL:IQ:FLAT:Q
Notes	The recommended procedure is to use the same BNC cable to calibrate all I/Q ports. All I/Q ports should be calibrated sequentially during the procedure. The calibration data is saved as soon as the port is calibrated and will survive power cycles. It is not reset by any preset or restore data commands.
Notes	The Q port must be connected to the Cal Out port before issuing the SCPI command.
State Saved	No
Initial S/W Revision	Prior to A.02.00

### Exit

Exit the calibration procedure. All ports calibrated before pressing Exit will use the newly acquired calibration data.

Key Path	Input/Output, I/Q, I/Q Cable Calibrate...
Notes	Using the Exit button will not restore the calibration data to the state prior to entering the guided calibration. Once a port is calibrated the data is stored immediately and the only way to change it is to redo the calibration step. When the calibration may be left in an inconsistent state, a confirmation dialog will be displayed (see <a href="#">"Exit Confirmation" on page 220</a> ).
Initial S/W Revision	Prior to A.02.00

### Q-bar Port

The Q-bar port calibration is performed with the front panel's Q-bar port connected via a short BNC cable to the Cal Out port. The guided calibration will show a diagram of the required connections.

### Back

Return to the prior step in the calibration procedure.

Key Path	Input/Output, I/Q, I/Q Cable Calibrate...
Notes	Using the Back button will not restore the calibration data to a prior state. Once a port is calibrated the data is stored immediately and the only way to change it is to redo the calibration step. The Back button allows the user to go back to a prior step to redo that calibration step.
Initial S/W Revision	Prior to A.02.00

### Next

Perform the Q-bar port calibration.

Key Path	Input/Output, I/Q, I/Q Cable Calibrate...
Remote Command	:CALibration:IQ:FLATness:QBAR
Example	CAL:IQ:FLAT:QBAR
Notes	The recommended procedure is to use the same BNC cable to calibrate all I/Q ports. All I/Q ports should be calibrated sequentially during the procedure. The calibration data is saved as soon as the port is calibrated and will survive power cycles. It is not reset by any preset or restore data commands.
Notes	The Q-bar port must be connected to the Cal Out port before issuing the SCPI command.
State Saved	No
Initial S/W Revision	Prior to A.02.00

#### Exit

Exit the calibration procedure. All ports calibrated before pressing Exit will use the newly acquired calibration data.

Key Path	Input/Output, I/Q, I/Q Cable Calibrate...
Notes	Using the Exit button will not restore the calibration data to the state prior to entering the guided calibration. Once a port is calibrated the data is stored immediately and the only way to change it is to redo the calibration step. When the calibration may be left in an inconsistent state, a confirmation dialog will be displayed (see <a href="#">"Exit Confirmation" on page 220</a> ).
Initial S/W Revision	Prior to A.02.00

#### I/Q Cable Calibration Time (Remote Command Only)

Returns the last date and time that the I/Q Cable Calibration was performed for a specific port. This is a remote query command only.

Remote Command	:CALibration:IQ:FLATness:I IBAR Q QBAR:TIME?
Example	:CAL:IQ:FLAT:I:TIME?
Notes	This returns 6 integer values: year, month, day, hour, minute, second. When no calibration has been performed, all values will be 0.
Initial S/W Revision	A.02.00

#### I/Q Probe Calibration

The I/Q probe calibration creates correction data for one of the front panel I/Q channels. When the probe has EEPROM identification, the data is unique to that specific probe. When the probe does not have EEPROM identification, the data will be used for all probes of the same type. The data is also unique to the channel, so calibration data for the I channel will not be used for the Q channel and vice versa.

The guided calibration (front panel only) will show connection diagrams and guide the user through the I/Q Isolation Calibration and through calibrating each port. The calibration data for each port is stored separately, so as soon as a port is calibrated that data is saved and will be used. If a user presses "Exit" to exit the calibration process, the data for the port already completed will still be used. It is recommended that a calibration be completed once started, or if exited, that it be properly done before the next use of the probe. The "Next" button will perform the calibration for the current port and then proceed to the next step in the calibration procedure. The "Back" button will return to the prior port in the procedure. Both softkeys and dialog buttons are supplied for ease of use. The dialog buttons are for mouse use and the softkeys for front panel use.

The calibration can also be done via SCPI, but no connection diagrams will be shown. The user will have to make the correct connections before issuing each port calibration command. Again, it is recommended that all ports be calibrated at the same time.

For Active probes or when Differential is Off, only the main port is calibrated, otherwise both the main and complementary ports are calibrated.

The instrument state remains as it was prior to entering the calibration procedure except while a port is actually being calibrated. Once a port is calibrated it returns to the prior state. A port calibration is in process only from the time the "Next" button is pressed until the next screen is shown. For SCPI, this corresponds to the time from issuing the CAL:IQ:PROB:|B|Q|QB command until the operation is complete.

For example, if the prior instrument state is Cal Out = Off, Input = I+jQ, and Differential = Off, then up until the time the "Next" button is pressed the I Input and Q Input LEDs are on and the Cal Out, I-bar Input and Q-bar Input LEDs are off. Once the "Next" button is pressed for the I port calibration, only the Cal Out and I Input LEDs will be on and the others will be off. When the screen progresses to the next step ("Next" button again enabled), the prior state is restored and only the I Input and Q Input LEDs are on (Cal Out is off again).

The last calibration date and time for each relevant port will be displayed. For passive probes with Differential On, any calibration that is more than a day older than the most recent calibration will be displayed with the color amber.

## I Port

The I port calibration is performed with the probe body attached to the front panel's I port and the probe tip connected via an adapter to the Cal Out port. The guided calibration will show a diagram of the required connections.

### Show Adapter

Show a connection diagram and instructions for the probe and adapter. See ["Show Adapter Screen" on page 220](#).

Key Path	Input/Output, I/Q, I Setup, I Probe, Calibrate
Notes	Either a passive or an active probe adapter diagram will be shown, depending on the type of probe attached.
Initial S/W Revision	Prior to A.02.00

## Back

Return to the prior step in the calibration procedure.

Key Path	Input/Output, I/Q, Q Setup, Q Probe, Calibrate
Initial S/W Revision	Prior to A.02.00

#### Next

Perform the I port calibration.

Key Path	Input/Output, I/Q, I Setup, I Probe, Calibrate
<b>Remote Command</b>	:CALibration:IQ:PROBe:I
<b>Example</b>	CAL:IQ:PROB:I
Notes	The I port must be connected to the Cal Out port before issuing the SCPI command. The calibration data is saved as soon as the port is calibrated and will survive power cycles. It is not reset by any preset or restore data commands.
State Saved	No
Initial S/W Revision	Prior to A.02.00

#### Exit

Exit the calibration procedure. All ports calibrated before pressing Exit will use the newly acquired calibration data.

Key Path	Input/Output, I/Q, I Setup, I Probe, Calibrate
Notes	Using the Exit button will not restore the calibration data to the state prior to entering the guided calibration. Once a port is calibrated the data is stored immediately and the only way to change it is to redo the calibration step. When the calibration may be left in an inconsistent state, a confirmation dialog will be displayed (see <a href="#">"Exit Confirmation" on page 220</a> ).
Initial S/W Revision	Prior to A.02.00

#### I-bar Port

The I-bar port calibration is performed with the probe body attached to the front panel's I-bar port and the probe tip connected via an adapter to the Cal Out port. The I-bar probe calibration is only available for passive probes with Differential On. The guided calibration will show a diagram of the required connections.

#### Show Adapter

Show a connection diagram and instructions for the probe and adapter. See ["Show Adapter Screen" on page 220](#).

Key Path	Input/Output, I/Q, I Setup, I Probe, Calibrate
Notes	Either a passive or an active probe adapter diagram will be shown, depending on the type of probe



---

attached.

---

Initial S/W Revision	Prior to A.02.00
----------------------	------------------

---

### Back

Return to the prior step in the calibration procedure.

---

Key Path	Input/Output, I/Q, I Setup, I Probe, Calibrate
Notes	Using the Back button will not restore the calibration data to a prior state. Once a port is calibrated the data is stored immediately and the only way to change it is to redo the calibration step. The Back button allows the user to go back to a prior step to redo that calibration step.
Initial S/W Revision	Prior to A.02.00

---

### Next

Perform the I-bar port calibration.

---

Key Path	Input/Output, I/Q, I Setup, I Probe, Calibrate
<b>Remote Command</b>	:CALibration:IQ:PROBe:IBar
<b>Example</b>	CAL:IQ:PROB:IB
Notes	The I-bar port must be connected to the Cal Out port before issuing the SCPI command. The calibration data is saved as soon as the port is calibrated and will survive power cycles. It is not reset by any preset or restore data commands.
State Saved	No
Initial S/W Revision	Prior to A.02.00

---

### Exit

Exit the calibration procedure. All ports calibrated before pressing Exit will use the newly acquired calibration data.

---

Key Path	Input/Output, I/Q, I Setup, I Probe, Calibrate
Notes	Using the Exit button will not restore the calibration data to the state prior to entering the guided calibration. Once a port is calibrated the data is stored immediately and the only way to change it is to redo the calibration step. When the calibration may be left in an inconsistent state, a confirmation dialog will be displayed (see <a href="#">"Exit Confirmation" on page 220</a> ).
Initial S/W Revision	Prior to A.02.00

---

## Q Port

The Q port calibration is performed with the probe body attached to the front panel's Q port and the probe tip connected via an adapter to the Cal Out port. The guided calibration will show a diagram of the required connections.

### Show Adapter

Show a connection diagram and instructions for the probe and adapter. See ["Show Adapter Screen" on page 220](#).

Key Path	Input/Output, I/Q, Q Setup, Q Probe, Calibrate
Notes	Either a passive or an active probe adapter diagram will be shown, depending on the type of probe attached.
Initial S/W Revision	Prior to A.02.00

### Back

Return to the prior step in the calibration procedure.

Key Path	Input/Output, I/Q, Q Setup, Q Probe, Calibrate
Initial S/W Revision	Prior to A.02.00

### Next

Perform the Q port calibration.

Key Path	Input/Output, I/Q, Q Setup, Q Probe, Calibrate
<b>Remote Command</b>	:CALibration:IQ:PROBe:Q
<b>Example</b>	CAL:IQ:PROB:Q
Notes	The Q port must be connected to the Cal Out port before issuing the SCPI command. The calibration data is saved as soon as the port is calibrated and will survive power cycles. It is not reset by any preset or restore data commands.
State Saved	No
Initial S/W Revision	Prior to A.02.00

### Exit

Exit the calibration procedure. All ports calibrated before pressing Exit will use the newly acquired calibration data.

Key Path	Input/Output, I/Q, Q Setup, Q Probe, Calibrate
Notes	Using the Exit button will not restore the calibration data to the state prior to entering the guided calibration. Once a port is calibrated the data is stored immediately and the only way to change it is

---

to redo the calibration step.

When the calibration may be left in an inconsistent state, a confirmation dialog will be displayed (see ["Exit Confirmation" on page 220](#) ).

---

Initial S/W Revision	Prior to A.02.00
----------------------	------------------

---

## Q-bar Port

The Q-bar port calibration is performed with the probe body attached to the front panel's Q-bar port and the probe tip connected via an adapter to the Cal Out port. The Q-bar probe calibration is only available for passive probes with Differential On. The guided calibration will show a diagram of the required connections.

### Show Adapter

Show a connection diagram and instructions for the probe and adapter. See ["Show Adapter Screen" on page 220](#).

---

Key Path	Input/Output, I/Q, Q Setup, Q Probe, Calibrate
Notes	Either a passive or an active probe adapter diagram will be shown, depending on the type of probe attached.
Initial S/W Revision	Prior to A.02.00

---

### Back

Return to the prior step in the calibration procedure.

---

Key Path	Input/Output, I/Q, Q Setup, Q Probe, Calibrate
Notes	Using the Back button will not restore the calibration data to a prior state. Once a port is calibrated the data is stored immediately and the only way to change it is to redo the calibration step. The Back button allows the user to go back to a prior step to redo that calibration step.
Initial S/W Revision	Prior to A.02.00

---

### Next

Perform the Q-bar port calibration.

---

Key Path	Input/Output, I/Q, Q Setup, Q Probe, Calibrate
<b>Remote Command</b>	:CALibration:IQ:PROBe:QBar
<b>Example</b>	CAL:IQ:PROB:QB
Notes	The Q-bar port must be connected to the Cal Out port before issuing the SCPI command. The calibration data is saved as soon as the port is calibrated and will survive power cycles. It is not reset by any preset or restore data commands.
State Saved	No
Initial S/W Revision	Prior to A.02.00

---

## Exit

Exit the calibration procedure. All ports calibrated before pressing Exit will use the newly acquired calibration data.

Key Path	Input/Output, I/Q, Q Setup, Q Probe, Calibrate
Notes	Using the Exit button will not restore the calibration data to the state prior to entering the guided calibration. Once a port is calibrated the data is stored immediately and the only way to change it is to redo the calibration step.  When the calibration may be left in an inconsistent state, a confirmation dialog will be displayed (see <a href="#">"Exit Confirmation" on page 220</a> ).
Initial S/W Revision	Prior to A.02.00

## Show Adapter Screen

When one of the Probe Calibration Show Adapter buttons is pressed, a diagram of the probe with its adapter will be shown. Depending on the type of probe attached, either the Passive Probe Adapter or the Active Probe Adapter diagram will be shown.

## I/Q Probe Calibration Time (Remote Command Only)

Return the last date and time that the I/Q Probe Calibration was performed for a specific port. This is a remote query command only.

Remote Command	:CALibration:IQ:PROBe:I IBAR Q QBAR:TIME?
Example	:CAL:IQ:PROB:I:TIME?
Notes	This returns 6 integer values: year, month, day, hour, minute, second. When no calibration has been performed, all values will be 0. The value is specific to both the port and probe, so the value will change as probes are connected or disconnected.
Initial S/W Revision	A.02.00

## Exit Confirmation

When Exit is pressed during one of the calibration routines, the calibration may be in an inconsistent state with some of the ports having newly measured calibration data and others with old data. If this is the case, a dialog box will appear to confirm that the user really wants to exit. A "Yes" answer will exit the calibration procedure, leaving potentially inconsistent calibration data in place. A "No" answer will return to the calibration procedure.

## 5 Mode Functions

## Mode

The Mode key allows you to select the available measurement applications or “Modes”. Modes are a collection of measurement capabilities packaged together to provide an instrument personality that is specific to your measurement needs. Each application software product is ordered separately by Model Number and must be licensed to be available. Once an instrument mode is selected, only the commands that are valid for that mode can be executed.

**NOTE**

Key operation can be different between modes. The information displayed in Help is about the current mode.

To access Help for a different Mode you must first exit Help (by pressing the Cancel (Esc) key). Then select the desired mode and re-access Help.

For more information on Modes, preloading Modes, and memory requirements for Modes, see ["More Information" on page 223](#)

Key Path	Front-panel key
<b>Remote Command</b>	:INSTrument[:SElect] SA   RTSA   SEQAN   EMI   BASIC   WCDMA   EDGE GSM   WIMAXOFDMA   VSA   PNOISE   NFIGure   ADEMOD   BTooth   TDSCDMA   CDMA2K   CDMA1XEV   LTE   LTETDD   LTEAFDD   LTEATDD   MSR   DVB   DTMB   DCATV   ISDBT   CMMB   WLAN   CWLAN   CWIMAXOFDM   WIMAXFIXED   IDEN   RLC   SCPI LC   VSA89601  :INSTrument[:SElect]?
<b>Example</b>	:INST SA
<b>Notes</b>	The available parameters are dependent upon installed and licensed applications resident in the instrument. Parameters given here are an example, specific parameters are in the individual Application.  A list of the valid mode choices is returned with the INST:CAT? Query.
<b>Preset</b>	This is unaffected by a Preset but is set on a “Restore System Defaults->All” to: For N9038A: EMI For N8973B, N8974B, N8975B, or N8976B: NFIG For all other models: SA
<b>State Saved</b>	Saved in instrument state
<b>Backwards Compatibility SCPI</b>	:INSTrument[:SElect] GSM provided for backwards compatibility. Mapped to EDGE GSM.
<b>Backwards Compatibility SCPI</b>	:INSTrument[:SElect] SANalyzer provided for ESU compatibility. When this command is received, the analyzer aliases it to the following: INST:SEL SCPI LC  This results in the analyzer being placed in SCPI Language Compatibility Mode, in order to emulate

	the ESU Spectrum Analyzer Mode.
<b>Backwards Compatibility SCPI</b>	:INSTrument[:SElect] RECeiver provided for ESU compatibility. When this command is received, the analyzer aliases it to the following: :INST:SEL EMI :CONF FSC This results in the analyzer being placed in the EMI Receiver Mode, running the Frequency Scan measurement, in order to emulate the ESU Receiver Mode.
Initial S/W Revision	Prior to A.02.00
Modified at S/W Revision	A.13.00

<b>Example</b>	:INST 'SA'
Notes	The query is not a quoted string. It is an enumeration as indicated in the Instrument Select table above. The command must be sequential: i.e. continued parsing of commands cannot proceed until the instrument select is complete and the resultant SCPI trees are available.
<b>Backwards Compatibility SCPI</b>	:INSTrument[:SElect] 'SA'   'PNOISE'   'EDGE'   'GSM'   'BASIC'
Initial S/W Revision	Prior to A.02.00

## More Information

The Mode name appears on the banner after the word “Agilent” followed by the Measurement Title. For example, for the Spectrum Analyzer mode with the Swept SA measurement running:



It is possible to specify the order in which the Modes appear in the Mode menu, using the Configure Applications utility (System, Power On, Configure Applications). It is also possible, using the same utility, to specify a subset of the available applications to load into memory at startup time, which can significantly decrease the startup time of the analyzer. During runtime, if an application that is not loaded into memory is selected (by either pressing that applications Mode key or sending that applications :INST:SEL command over SCPI), there will be a pause while the Application is loaded. During this pause a message box that says “Loading application, please wait...” is displayed.

Each application (Mode) that runs in the X-Series signal analyzers consumes virtual memory. The various applications consume varying amounts of virtual memory, and as more applications run, the memory consumption increases. Once an application is run, some of its memory remains allocated even when it is not running, and is not released until the analyzer program (xSA.exe) is shut down.

Agilent characterizes each Mode and assigns a memory usage quantity based on a conservative estimate. There is a limited amount of virtual memory available to applications (note that this is virtual memory and is independent of how much physical RAM is in the instrument). The instrument keeps track of how much

memory is being used by all loaded applications – which includes those that preloaded at startup, and all of those that have been run since startup.

When you request a Mode that is not currently loaded, the instrument looks up the memory estimate for that Mode, and adds it to the residual total for all currently loaded Modes. If there is not enough virtual memory to load the Mode, a dialog box and menu will appear that gives you four options:

1. Close and restart the analyzer program without changing your configured preloads. This may free up enough memory to load the requested Mode, depending on your configured preloads
2. Clear out all preloads and close and restart the analyzer program with only the requested application preloaded, and with that application running. This choice is guaranteed to allow you to run the requested application; but you will lose your previously configured preloads. In addition, there may be little or no room for other applications, depending on the size of the requested application.
3. Bring up the Configure Applications utility in order to reconfigure the preloaded apps to make room for the applications you want to run (this will then require restarting the analyzer program with your new configuration). This is the recommended choice because it gives you full flexibility to select exactly what you want.
4. Exit the dialog box without doing anything, which means you will be unable to load the application you requested.

In each case except 4, this will cause the analyzer software to close, and you will lose all unsaved traces and results.

If you attempt to load a mode via SCPI that will exceed memory capacity, the Mode does not load and an error message is returned:

```
-225,"Out of memory;Insufficient resources to load Mode (mode name)"
```

where “mode name” is the SCPI parameter for the Mode in question, for example, SA for Spectrum Analyzer Mode.

## Spectrum Analyzer

Selects the Spectrum Analyzer mode for general purpose measurements. There are several measurements available in this mode. General spectrum analysis measurements, in swept and zero span, can be done using the first key in the Meas menu, labeled Swept SA. Other measurements in the Meas Menu are designed to perform specialized measurement tasks, including power and demod measurements.

If you are using the Help feature, this mode must be currently active to access its detailed information. If it is not active, exit the Help feature (Esc key), select the mode, and re-access Help.

Key Path	Mode
<b>Example</b>	INST:SEL SA INST:NSEL 1
Initial S/W Revision	Prior to A.02.00



## EMI Receiver

The EMI Receiver Mode makes EMC measurements. Several measurements are provided to aid the user in characterizing EMC performance of their systems, including looking at signals with CISPR-16 compliant detectors, performing scans for interfering signals, and determining and charting interfering signals over time.

If you are using the Help feature, this mode must be currently active to access its detailed information. If it is not active, exit the Help feature (Esc key), select the mode, and re-access Help.

Key Path	Mode
<b>Example</b>	INST:SEL EMI INST:NSEL 141
Initial S/W Revision	A.07.01

## IQ Analyzer (Basic)

The IQ Analyzer Mode makes general purpose frequency domain and time domain measurements. These measurements often use alternate hardware signal paths when compared with a similar measurement in the Signal Analysis Mode using the Swept SA measurement. These frequency domain and time domain measurements can be used to output I/Q data results when measuring complex modulated digital signals.

If you are using the Help feature, this mode must be currently active to access its detailed information. If it is not active, exit the Help feature (Esc key), select the mode, and re-access Help.

Key Path	Mode
<b>Example</b>	INST:SEL BASIC INST:NSEL 8
Initial S/W Revision	Prior to A.02.00

## Phase Noise

The Phase Noise mode provides pre-configured measurements for making general purpose measurements of device phase noise.

If you are using the Help feature, this mode must be currently active to access its detailed information. If it is not active, exit the Help feature (Esc key), select the mode, and re-access Help.

Key Path	Mode
<b>Example</b>	INST:SEL PNOISE or INST:NSEL 14
Initial S/W Revision	Prior to A.02.00

## Noise Figure

The Noise Figure mode provides pre-configured measurements for making general purpose measurements of device noise figure.

If you are using the Help feature, this mode must be currently active to access its detailed information. If it is not active, exit the Help feature (Esc key), select the mode, and re-access Help.

Key Path	Mode
<b>Example</b>	INST:SEL NFIGURE INST:NSEL 219
Initial S/W Revision	Prior to A.02.00

## Analog Demod

Selects the Analog Demod mode for making measurements of AM, FM and phase modulated signals.

If you are using the Help feature, this mode must be currently active to access its detailed information. If it is not active, exit the Help feature (Esc key), select the mode, and re-access Help.

Key Path	Mode
<b>Example</b>	INST:SEL ADEMOM INST:NSEL 234
Initial S/W Revision	Prior to A.02.00

## SCPI Language Compatibility

The SCPI Language Compatibility mode provides remote language compatibility for SCPI-based instruments, such as the Rohde and Schwartz FSP and related series of spectrum analyzers.

**NOTE** After changing into or out of this mode, allow a 1 second delay before sending any subsequent commands.

If you are using the Help feature, this mode must be currently active to access its detailed information. If it is not active, exit the Help feature (Esc key), select the mode, and re-access Help.

Key Path	Mode
<b>Example</b>	INST:SEL SCPILC Or INST:NSEL 270
Initial S/W Revision	A.06.00

## 89601 VSA

Selecting the 89601 VSA mode will start the 89600 VSA software. The 89600 VSA software is powerful, PC-based software, offering the industry's most sophisticated general purpose and standards specific signal evaluation and troubleshooting tools for R&D engineers. Even for proprietary and non-standard signals in SATCOM or MILCOM applications, you can make signal quality measurements with customized IQ constellation. Reach deeper into signals, gather more data on signal problems, and gain greater insight.

- Over 35 general-purpose analog and digital demodulators ranging from 2FSK to 4096QAM
- Flexible and custom IQ and OFDM signal analysis for single carrier
- Standards specific modulation analysis including:
  - Cellular: GSM/EDGE, cdma2000, W-CDMA, TD-SCDMA, LTE(FDD/TDD),
  - LTE-Advanced and more
  - Wireless networking: 802.11a/b/g, 802.11n, 802.ac, 802.16 WiMAX (fixed/mobile), WiSUN (MR-FSK PHY)
  - RFID
  - Digital satellite video and other satellite signals, radar, LMDS
  - Up to 400K bin FFT, for the highest resolution spectrum analysis
  - A full suite of time domain analysis tools, including signal capture and playback, time gating, and CCDF measurements
  - 20 simultaneous trace displays and the industry's most complete set of marker functions
  - Easy-to-use Microsoft® Windows® graphical user interface

For more information see the Agilent 89600 Series VSA web site at [www.agilent.com/find/89600vsa](http://www.agilent.com/find/89600vsa)

To learn more about how to use the 89600 VSA running in the X-Series, after the 89600 VSA software is running, open the 89600 VSA Help and open the "About Agilent X-Series Signal Analyzer with 89600 VSA Software" help topic.

Key Path	Mode
<b>Example</b>	INST:SEL VSA89601 INST:NSEL 101
Initial S/W Revision	Prior to A.02.00

## Application Mode Number Selection (Remote Command Only)

Select the measurement mode by its mode number. The actual available choices depend upon which applications are installed in your instrument. The modes appear in this table in the same order they appear in the Mode menu (if the order is not changed by the Configure Applications utility found in the System, Power On menu). See "[Detailed List of Modes](#)" on [page 232](#) for Mode details.

The Mode Number is the parameter for use with the :INSTrument:NSElect command. The Mode Parameter is the parameter for use with the :INSTrument[:SElect] command.

Mode	Mode Number	Mode Parameter
Spectrum Analyzer	1	SA
Real Time Spectrum Analyzer	107	RTSA
Sequence Analyzer	400	SEQAN
EMI Receiver	141	EMI
I/Q Analyzer (Basic)	8	BASIC
WCDMA with HSPA+	9	WCDMA
GSM/EDGE/EDGE Evo	13	EDGE GSM
802.16 OFDMA (WiMAX/WiBro)	75	WIMAX OFDMA
Vector Signal Analyzer (VXA)	100	VSA
Phase Noise	14	PNOISE
Noise Figure	219	NFIGure
Analog Demod	234	ADEMOD
Bluetooth	228	BTtooth
TD-SCDMA with HSPA/8PSK	211	TDSCDMA
cdma2000	10	CDMA2K
1xEV-DO	15	CDMA1XEV
LTE	102	LTE
LTE TDD	105	LTETDD
LTE-Advanced FDD	107	LTEAFDD
LTE-Advanced TDD	108	LTEATDD
MSR	106	MSR
DVB-T/H with T2	235	DVB
DTMB (CTTB)	236	DTMB
Digital Cable TV	238	DCATV
ISDB-T	239	ISDBT
CMMB	240	CMMB
WLAN	217	WLAN
Combined WLAN	19	CWLAN
Combined Fixed WiMAX	81	CWIMAX OFDM
802.16 OFDM (Fixed WiMAX)	104	WIMAX FIXED
iDEN/WiDEN/MotoTalk	103	IDEN
Remote Language Compatibility	266	RLC
SCPI Language Compatibility	270	SCPILC
89601 VSA	101	VSA89601

<b>Remote Command</b>	:INSTRument:NSElect <integer> :INSTRument:NSElect?
<b>Example</b>	:INST:NSEL 1
<b>Notes</b>	SA mode is 1 The command must be sequential: i.e. continued parsing of commands cannot proceed until the instrument select is complete and the resultant SCPI trees are available.
<b>Preset</b>	Not affected by Preset. Set to default mode (1 for SA mode) following Restore System Defaults.
<b>State Saved</b>	Saved in instrument state
<b>Initial S/W Revision</b>	Prior to A.02.00

### Application Mode Catalog Query (Remote Command Only)

Returns a string containing a comma separated list of names of all the installed and licensed measurement modes (applications). These names can only be used with the :INSTRument[:SElect] command.

<b>Remote Command</b>	:INSTRument:CATalog?
<b>Example</b>	:INST:CAT?
<b>Notes</b>	Query returns a quoted string of the installed and licensed modes separated with a comma. Example: "SA,PNOISE,WCDMA"
<b>Backwards Compatibility Notes</b>	VSA (E4406A) :INSTRument:CATalog? returned a list of installed INSTRument:SELECT items as a comma separated list of string values: "BASIC","GSM","EDGE GSM","CDMA","NADC","PDC","WCDMA","CDMA2K","CDMA1XEV","IDEN","WIDEN","WLAN","SERVICE" X-Series uses the ESA/PSA compatible query of a string contain comma separated values: "SA,PNOISE,NFIGURE,BASIC,CDMA,CDMA2K,WCDMA,CDMA1XEV,EDGE GSM,GSM,NADC,PDC,TDSCDMA,DMODULATION,WLAN"
<b>Initial S/W Revision</b>	Prior to A.02.00

### Application Identification (Remote Commands Only)

Each entry in the Mode Menu will have a Model Number and associated information: Version, and Options.

This information is displayed in the Show System screen. The corresponding SCPI remote commands are defined here.

"Current Application Model " on page 230

"Current Application Revision" on page 230

"Current Application Options" on page 230

### Current Application Model

Returns a string that is the Model Number of the currently selected application (mode).

<b>Remote Command</b>	:SYSTem:APPLication[:CURRent][:NAME]?
<b>Example</b>	:SYST:APPL?
<b>Notes</b>	Query returns a quoted string that is the Model Number of the currently selected application (Mode). Example: "N9060A" String length is 6 characters.
<b>Preset</b>	Not affected by Preset
<b>State Saved</b>	Not saved in state, the value will be the selected application when a Save is done.
<b>Initial S/W Revision</b>	Prior to A.02.00

### Current Application Revision

Returns a string that is the Revision of the currently selected application (mode).

<b>Remote Command</b>	:SYSTem:APPLication[:CURRent]:REVision?
<b>Example</b>	:SYST:APPL:REV?
<b>Notes</b>	Query returns a quoted string that is the Revision of the currently selected application (Mode). Example: "1.0.0.0" String length is a maximum of 23 characters. (each numeral can be an integer + 3 decimal points)
<b>Preset</b>	Not affected by a Preset
<b>State Saved</b>	Not saved in state, the value will be the selected application when a Save is done.
<b>Initial S/W Revision</b>	Prior to A.02.00

### Current Application Options

Returns a string that is the Options list of the currently selected application (Mode).

<b>Remote Command</b>	:SYSTem:APPLication[:CURRent]:OPTion?
<b>Example</b>	:SYST:APPL:OPT?
<b>Notes</b>	Query returns a quoted string that is the Option list of the currently selected application (Mode). The format is the name as the *OPT? or SYSTem:OPTion command: a comma separated list of option identifiers. Example: "1FP,2FP" String length is a maximum of 255 characters.

Preset	Not affected by a Preset
State Saved	Not saved in state per se, the value will be the selected application when a Save is invoked.
Initial S/W Revision	Prior to A.02.00

## Application Identification Catalog (Remote Commands Only)

A catalog of the installed and licensed applications (Modes) can be queried for their identification.

"Application Catalog Number of Entries" on page 231

"Application Catalog Model Numbers" on page 231

"Application Catalog Revision" on page 231

"Application Catalog Options" on page 232

### Application Catalog Number of Entries

Returns the number of installed and licensed applications (Modes).

<b>Remote Command</b>	:SYSTem:APPLication:CATalog[:NAME]:COUNT?
<b>Example</b>	:SYST:APPL:CAT:COUN?
Preset	Not affected by Preset
State Saved	Not saved in instrument state.
Initial S/W Revision	Prior to A.02.00

### Application Catalog Model Numbers

Returns a list of Model Numbers for the installed and licensed applications (Modes).

<b>Remote Command</b>	:SYSTem:APPLication:CATalog[:NAME]?
<b>Example</b>	:SYST:APPL:CAT?
Notes	Returned value is a quoted string of a comma separated list of Model Numbers. Example, if SAMS and Phase Noise are installed and licensed: "N9060A,N9068A" String length is COUNT * 7 - 1. (7 = Model Number length + 1 for comma. -1 = no comma for the 1st entry.)
Preset	Not affected by a Preset
State Saved	Not saved in instrument state.
Initial S/W Revision	Prior to A.02.00

### Application Catalog Revision

Returns the Revision of the provided Model Number.

<b>Remote Command</b>	:SYSTem:APPLication:CATalog:REVision? <model>
<b>Example</b>	:SYST:APPL:CAT:REV? 'N9060A'
<b>Notes</b>	Returned value is a quoted string of revision for the provided Model Number. The revision will be a null-string ("") if the provided Model Number is not installed and licensed. Example, if SAMS is installed and licensed: "1.0.0.0"
<b>Preset</b>	Not affected by a Preset.
<b>State Saved</b>	Not saved in instrument state.
<b>Initial S/W Revision</b>	Prior to A.02.00

### Application Catalog Options

Returns a list of Options for the provided Model Number

<b>Remote Command</b>	:SYSTem:APPLication:CATalog:OPTion? <model>
<b>Example</b>	:SYST:APPL:CAT:OPT? 'N9060A'
<b>Notes</b>	Returned value is a quoted string of a comma separated list of Options, in the same format as *OPT? or :SYSTem:OPTion?. If the provided Model Number is not installed and licensed a null-string ("") will be returned. Example, if SAMS is installed and licensed: "2FP" String length is a maximum of 255 characters.
<b>Preset</b>	Not affected by a Preset
<b>State Saved</b>	Not saved in instrument state.
<b>Initial S/W Revision</b>	Prior to A.02.00

### Detailed List of Modes

This section contains an alphabetical list of Modes available in the X-Series, along with a brief description of each Mode.

Note that with the exception of the 89601 VSA, only licensed applications appear in the Mode menu. The 89601 will always appear, because it's licensing is handled differently.

#### 1xEV-DO

Selects the 1xEV-DO mode for general purpose measurements of signals following this standard. There are several measurements available in this mode.

If you are using the Help feature, this mode must be currently active to access its detailed information. If it is not active, exit the Help feature (Esc key), select the mode, and re-access Help.

Key Path	Mode
----------	------



<b>Example</b>	INST:SEL CDMA1XEV INST:NSEL 15
Initial S/W Revision	Prior to A.02.00

### 802.16 OFDMA (WiMAX/WiBro)

Selects the OFDMA mode for general purpose measurements of WiMAX signals. There are several measurements available in this mode.

If you are using the Help feature, this mode must be currently active to access its detailed information. If it is not active, exit the Help feature (Esc key), select the mode, and re-access Help.

Key Path	Mode
<b>Example</b>	INST:SEL WIMAXOFDMA INST:NSEL 75
Initial S/W Revision	Prior to A.02.00

### 802.16 OFDM (Fixed WiMAX)

Selects the 802.16 OFDM (Fixed WiMAX) mode. This mode allows modulation quality measurements of signals that comply with IEEE 802.16a–2003 and IEEE 802.16–2004 standards, with flexibility to measure nonstandard OFDM formats. Along with the typical digital demodulation measurement results, several additional 802.16 OFDM unique trace data formats and numeric error data results provide enhanced data analysis.

If you are using the Help feature, this mode must be currently active to access its detailed information. If it is not active, exit the Help feature (Esc key), select the mode, and re-access Help.

Key Path	Mode
<b>Example</b>	INST:SEL WIMAXFIXED INST:NSEL 104
Initial S/W Revision	A.02.00

### 89601 VSA

Selecting the 89601 VSA mode will start the 89600 VSA software. The 89600 VSA software is powerful, PC-based software, offering the industry's most sophisticated general purpose and standards specific signal evaluation and troubleshooting tools for R&D engineers. Even for proprietary and non-standard signals in SATCOM or MILCOM applications, you can make signal quality measurements with customized IQ constellation. Reach deeper into signals, gather more data on signal problems, and gain greater insight.

- Over 35 general-purpose analog and digital demodulators ranging from 2FSK to 4096QAM
- Flexible and custom IQ and OFDM signal analysis for single carrier

- Standards specific modulation analysis including:
  - Cellular: GSM/EDGE, cdma2000, W-CDMA, TD-SCDMA, LTE(FDD/TDD),
  - LTE-Advanced and more
  - Wireless networking: 802.11a/b/g, 802.11n, 802.ac, 802.16 WiMAX (fixed/mobile), WiSUN (MR-FSK PHY)
  - RFID
  - Digital satellite video and other satellite signals, radar, LMDS
  - Up to 400K bin FFT, for the highest resolution spectrum analysis
  - A full suite of time domain analysis tools, including signal capture and playback, time gating, and CCDF measurements
  - 20 simultaneous trace displays and the industry's most complete set of marker functions
  - Easy-to-use Microsoft ® Windows ® graphical user interface

For more information see the Agilent 89600 Series VSA web site at [www.agilent.com/find/89600vsa](http://www.agilent.com/find/89600vsa)

To learn more about how to use the 89600 VSA running in the X-Series, after the 89600 VSA software is running, open the 89600 VSA Help and open the "About Agilent X-Series Signal Analyzer with 89600 VSA Software" help topic.

Key Path	Mode
<b>Example</b>	INST:SEL VSA89601 INST:NSEL 101
Initial S/W Revision	Prior to A.02.00

### Analog Demod

Selects the Analog Demod mode for making measurements of AM, FM and phase modulated signals.

If you are using the Help feature, this mode must be currently active to access its detailed information. If it is not active, exit the Help feature (Esc key), select the mode, and re-access Help.

Key Path	Mode
<b>Example</b>	INST:SEL ADEMOM INST:NSEL 234
Initial S/W Revision	Prior to A.02.00

### Bluetooth

Selects the Bluetooth mode for Bluetooth specific measurements. There are several measurements available in this mode.

If you are using the Help feature, this mode must be currently active to access its detailed information. If it is not active, exit the Help feature (Esc key), select the mode, and re-access Help.

Key Path	Mode
<b>Example</b>	INST:SEL BT INST:NSEL 228
Initial S/W Revision	A.06.01

### cdma2000

Selects the cdma2000 mode for general purpose measurements of signals following this standard. There are several measurements available in this mode.

If you are using the Help feature, this mode must be currently active to access its detailed information. If it is not active, exit the Help feature (Esc key), select the mode, and re-access Help.

Key Path	Mode
<b>Example</b>	INST:SEL CDMA2K INST:NSEL 10
Initial S/W Revision	Prior to A.02.00

### CMMB

Selects the CMMB mode for measurements of digital video signals using this format. There are several power and demod measurements available in this mode.

If you are using the Help feature, this mode must be currently active to access its detailed information. If it is not active, exit the Help feature (Esc key), select the mode, and re-access Help.

Key Path	Mode
<b>Example</b>	INST:SEL CMMB INST:NSEL 240
Initial S/W Revision	A.03.00

### Combined WLAN

Selects the CWLAN mode for general purpose measurements of signals following this standard. There are several measurements available in this mode.

If you are using the Help feature, this mode must be currently active to access its detailed information. If it is not active, exit the Help feature (Esc key), select the mode, and re-access Help.

Key Path	Mode
<b>Example</b>	INST:SEL CWLAN

---

	INST:NSEL 19
Initial S/W Revision	A.02.00

---

### Combined Fixed WiMAX

Selects the Combined Fixed WiMAX mode for general purpose measurements of signals following this standard. There are several measurements available in this mode.

If you are using the Help feature, this mode must be currently active to access its detailed information. If it is not active, exit the Help feature (Esc key), select the mode, and re-access Help.

---

Key Path	Mode
<b>Example</b>	INST:SEL CWIMAXOFDM INST:NSEL 81
Initial S/W Revision	A.02.00

---

### Digital Cable TV

Selects the Digital Cable TV mode for measurements of digital cable television systems. There are several power and demod measurements available in this mode.

If you are using the Help feature, this mode must be currently active to access its detailed information. If it is not active, exit the Help feature (Esc key), select the mode, and re-access Help.

---

Key Path	Mode
<b>Example</b>	INST:SEL DCATV INST:NSEL 238
Initial S/W Revision	A.07.00

---

### DTMB (CTTB)

Selects the DTMB (CTTB) mode for measurements of digital video signals using this format. There are several power and demod measurements available in this mode.

If you are using the Help feature, this mode must be currently active to access its detailed information. If it is not active, exit the Help feature (Esc key), select the mode, and re-access Help.

---

Key Path	Mode
<b>Example</b>	INST:SEL DTMB INST:NSEL 236
Initial S/W Revision	A.02.00

---

## DVB-T/H with T2

Selects the DVB-T/H mode for measurements of digital video signals using this format. There are several power and demod measurements available in this mode.

If you are using the Help feature, this mode must be currently active to access its detailed information. If it is not active, exit the Help feature (Esc key), select the mode, and re-access Help.

Key Path	Mode
<b>Example</b>	INST:SEL DVB INST:NSEL 235
Initial S/W Revision	A.02.00
Modified at S/W Revision	A.07.00

## EMI Receiver

The EMI Receiver Mode makes EMC measurements. Several measurements are provided to aid the user in characterizing EMC performance of their systems, including looking at signals with CISPR-16 compliant detectors, performing scans for interfering signals, and determining and charting interfering signals over time.

If you are using the Help feature, this mode must be currently active to access its detailed information. If it is not active, exit the Help feature (Esc key), select the mode, and re-access Help.

Key Path	Mode
<b>Example</b>	INST:SEL EMI INST:NSEL 141
Initial S/W Revision	A.07.01

## GSM/EDGE/EDGE Evo

Selects the GSM with EDGE mode for general purpose measurements of signals following this standard. There are several measurements available in this mode.

If you are using the Help feature, this mode must be currently active to access its detailed information. If it is not active, exit the Help feature (Esc key), select the mode, and re-access Help.

Key Path	Mode
<b>Example</b>	INST:SEL EDGE GSM INST:NSEL 13
Initial S/W Revision	Prior to A.02.00
Modified at S/W Revision	A.02.00

### iDEN/WiDEN/MOTOTalk

Selects the iDEN/WiDEN/MOTOTalk mode for general purpose measurements of iDEN and iDEN-related signals. There are several measurements available in this mode.

If you are using the Help feature, this mode must be currently active to access its detailed information. If it is not active, exit the Help feature (Esc key), select the mode, and re-access Help.

Key Path	Mode
<b>Example</b>	INST:SEL IDEN INST:NSEL 103
Initial S/W Revision	A.02.00

### IQ Analyzer (Basic)

The IQ Analyzer Mode makes general purpose frequency domain and time domain measurements. These measurements often use alternate hardware signal paths when compared with a similar measurement in the Signal Analysis Mode using the Swept SA measurement. These frequency domain and time domain measurements can be used to output I/Q data results when measuring complex modulated digital signals.

If you are using the Help feature, this mode must be currently active to access its detailed information. If it is not active, exit the Help feature (Esc key), select the mode, and re-access Help.

Key Path	Mode
<b>Example</b>	INST:SEL BASIC INST:NSEL 8
Initial S/W Revision	Prior to A.02.00

### ISDB-T

Selects the ISDB-T mode for measurements of digital video signals using this format. There are several power and demod measurements available in this mode.

If you are using the Help feature, this mode must be currently active to access its detailed information. If it is not active, exit the Help feature (Esc key), select the mode, and re-access Help.

Key Path	Mode
<b>Example</b>	INST:SEL ISDBT INST:NSEL 239
Initial S/W Revision	A.03.00

### LTE

Selects the LTE mode for general purpose measurements of signals following the LTE FDD standard. There are several measurements available in this mode.

If you are using the Help feature, this mode must be currently active to access its detailed information. If it is not active, exit the Help feature (Esc key), select the mode, and re-access Help.

Key Path	Mode
<b>Example</b>	INST:SEL LTE INST:NSEL 102
Initial S/W Revision	Prior to A.02.00

## LTE TDD

Selects the LTE TDD mode for general purpose measurements of signals following the LTE TDD standard. There are several measurements available in this mode.

If you are using the Help feature, this mode must be currently active to access its detailed information. If it is not active, exit the Help feature (Esc key), select the mode, and re-access Help.

Key Path	Mode
<b>Example</b>	INST:SEL LTETDD INST:NSEL 105
Initial S/W Revision	A.03.00

## LTE-Advanced FDD

As LTE-Advanced FDD and LTE modes are converged into one single application, the single softkey under Mode menu is designed to select the converged mode. The display mode of the LTE and LTE-Advanced FDD are distinguished by the licenses.

If you are using the Help feature, this mode must be currently active to access its detailed information. If it is not active, exit the Help feature (Esc key), select the mode, and re-access Help.

Key Path	Mode
<b>Example</b>	INST:SEL LTEAFDD INST:NSEL 107
Notes	When the N9080A/80B-1FP exists, the display mode name is LTE. When the N9080A/80B-1FP and N9080B-2FP all exist, the display mode name is LTE FDD & LTE-A FDD.
<b>Backwards Compatibility SCPI</b>	INST:SEL LTE INST:NSEL 102
Initial S/W Revision	A.14.00
Modified at S/W Revision	A.14.50

### LTE-Advanced TDD

As LTE-Advanced TDD and LTE TDD modes are converged into one single application, the single softkey under Mode menu is designed to select the covered mode. The display mode of the LTE TDD and LTE-Advanced TDD are distinguished by the licenses.

If you are using the Help feature, this mode must be currently active to access its detailed information. If it is not active, exit the Help feature (Esc key), select the mode, and re-access Help.

Key Path	Mode
<b>Example</b>	INST:SEL LTEATDD INST:NSEL 108
<b>Notes</b>	When the N9082A/82B-1FP exists, the display mode name is LTE TDD. When the N9082A/82B-1FP and N9082B-2FP all exist, the display mode name is LTE TDD & LTE-A TDD.
<b>Backwards Compatibility SCPI</b>	INST:SEL LTETDD INST:NSEL 105
Initial S/W Revision	A.14.00
Modified at S/W Revision	A.14.50

### MSR

Selects the MSR mode. The MSR mode makes several measurements for Cellular Communication devices that can be configured with multiple radio formats simultaneously following the 3GPP standard of Multi-Standard Radio, including GSM/EDGE, WCDMA/HSPA+ and LTE.

If you are using the Help feature, this mode must be currently active to access its detailed information. If it is not active, exit the Help feature (Esc key), select the mode, and re-access Help.

Key Path	Mode
<b>Example</b>	INST:SEL MSR INST:NSEL 106
Initial S/W Revision	A.09.491

### Noise Figure

The Noise Figure mode provides pre-configured measurements for making general purpose measurements of device noise figure.

If you are using the Help feature, this mode must be currently active to access its detailed information. If it is not active, exit the Help feature (Esc key), select the mode, and re-access Help.

Key Path	Mode
<b>Example</b>	INST:SEL NFIGURE INST:NSEL 219
Initial S/W Revision	Prior to A.02.00



## Phase Noise

The Phase Noise mode provides pre-configured measurements for making general purpose measurements of device phase noise.

If you are using the Help feature, this mode must be currently active to access its detailed information. If it is not active, exit the Help feature (Esc key), select the mode, and re-access Help.

Key Path	Mode
<b>Example</b>	INST:SEL PNOISE or INST:NSEL 14
Initial S/W Revision	Prior to A.02.00

## Real Time Spectrum Analyzer

The Real Time Spectrum Analyzer (RTSA) mode provides real-time signal analysis, very high probability-of-intercept for intermittent signals with appropriate triggers.

If you are using the Help feature, this mode must be currently active to access its detailed information. If it is not active, exit the Help feature (Esc key), select the mode, and re-access Help.

Key Path	Mode
<b>Example</b>	INST:SEL RTSA or INST:NSEL 107
Initial S/W Revision	A.13.00

## Remote Language Compatibility

The Remote Language Compatibility (RLC) mode provides remote command backwards compatibility for the 8560 series of spectrum analyzers, known as legacy spectrum analyzers.

**NOTE** After changing into or out of this mode, allow a 1 second delay before sending any subsequent commands.

If you are using the Help feature, this mode must be currently active to access its detailed information. If it is not active, exit the Help feature (Esc key), select the mode, and re-access Help.

Key Path	Mode
<b>Example</b>	INST:SEL RLC Or INST:NSEL 266
Initial S/W Revision	Prior to A.02.00

## SCPI Language Compatibility

The SCPI Language Compatibility mode provides remote language compatibility for SCPI-based instruments, such as the Rohde and Schwartz FSP and related series of spectrum analyzers.

**NOTE** After changing into or out of this mode, allow a 1 second delay before sending any subsequent commands.

If you are using the Help feature, this mode must be currently active to access its detailed information. If it is not active, exit the Help feature (Esc key), select the mode, and re-access Help.

Key Path	Mode
<b>Example</b>	INST:SEL SCPILC Or INST:NSEL 270
Initial S/W Revision	A.06.00

## Spectrum Analyzer

Selects the Spectrum Analyzer mode for general purpose measurements. There are several measurements available in this mode. General spectrum analysis measurements, in swept and zero span, can be done using the first key in the Meas menu, labeled Swept SA. Other measurements in the Meas Menu are designed to perform specialized measurement tasks, including power and demod measurements.

If you are using the Help feature, this mode must be currently active to access its detailed information. If it is not active, exit the Help feature (Esc key), select the mode, and re-access Help.

Key Path	Mode
<b>Example</b>	INST:SEL SA INST:NSEL 1
Initial S/W Revision	Prior to A.02.00

## TD-SCDMA with HSPA/8PSK

Selects the TD-SCDMA mode for general purpose measurements of signals following this standard. There are several measurements available in this mode.

If you are using the Help feature, this mode must be currently active to access its detailed information. If it is not active, exit the Help feature (Esc key), select the mode, and re-access Help.

Key Path	Mode
<b>Example</b>	INST:SEL TDSCDMA INST:NSEL 211
Initial S/W Revision	Prior to A.02.00

## Vector Signal Analyzer (VXA)

The N9064A (formerly 89601X) VXA Vector signal and WLAN modulation analysis application provides solutions for basic vector signal analysis, analog demodulation, and digital demodulation. The digital demodulation portion of N9064A allows you to perform measurements on standard-based formats such as cellular, wireless networking and digital video as well as general purpose flexible modulation analysis for wide range of digital formats, FSK to 1024QAM, with easy-to-use measurements and display tools such as constellation and eye diagram, EVM traces and up to four simultaneous displays. Analog baseband analysis is available using the MXA and PXA with option BBA. Option 3FP WLAN has been discontinued.

N9064A honors existing 89601X licenses with all features and functionalities found on X-Series software versions prior to A.06.00. Specifically:

N9064A-1 is equivalent to 89601X-205

N9064A-2 is equivalent to 89601X-AYA

If you are using the Help feature, this mode must be currently active to access its detailed information. If it is not active, exit the Help feature (Esc key), select the mode, and re-access Help.

Key Path	Mode
<b>Example</b>	INST:SEL VSA INST:NSEL 100
Initial S/W Revision	Prior to A.02.00

## W-CDMA with HSPA+

Selects the W-CDMA with HSPA+ mode for general purpose measurements of signals following this standard. There are several measurements available in this mode.

If you are using the Help feature, this mode must be currently active to access its detailed information. If it is not active, exit the Help feature (Esc key), select the mode, and re-access Help.

Key Path	Mode
<b>Example</b>	INST:SEL WCDMA INST:NSEL 9
Initial S/W Revision	Prior to A.02.00

## WLAN

Selects the WLAN mode for general purpose measurements of signals following this standard. There are several measurements available in this mode.

If you are using the Help feature, this mode must be currently active to access its detailed information. If it is not active, exit the Help feature (Esc key), select the mode, and re-access Help.

Key Path	Mode
----------	------

<b>Example</b>	INST:SEL WLAN INST:NSEL 217
Initial S/W Revision	A.09.491

## Global Settings

Opens a menu that allows you to switch certain Meas Global parameters to a Mode Global state. These switches apply to all Modes that support global settings. No matter what Mode you are in when you set the “Global Center Frequency” switch to on, it applies to all Modes that support Global Settings.

<b>Key Path</b>	<b>Mode Setup</b>
Initial S/W Revision	Prior to A.02.00

## Global Center Freq

The software maintains a Mode Global value called “Global Center Freq”.

When the Global Center Freq key is switched to On in any mode, the current mode’s center frequency is copied into the Global Center Frequency, and from then on all modes that support global settings use the Global Center Frequency. So you can switch between any of these modes and the Center Freq will remain unchanged.

Adjusting the Center Freq of any mode which supports Global Settings, while Global Center Freq is On, will modify the Global Center Frequency.

When Global Center Freq is turned Off, the Center Freq of the current mode is unchanged, but now the Center Freq of each mode is once again independent.

When Mode Preset is pressed while Global Center Freq is On, the Global Center Freq is preset to the preset Center Freq of the current mode.

This function is reset to Off when the Restore Defaults key is pressed in the Global Settings menu, or when System, Restore Defaults, All Modes is pressed.

<b>Key Path</b>	<b>Mode Setup, Global Settings</b>
<b>Scope</b>	<b>Mode Global</b>
<b>Remote Command</b>	:INSTrument:COUPle:FREQuency:CENTer ALL NONE :INSTrument:COUPle:FREQuency:CENTer?
<b>Example</b>	INST:COUP:FREQ:CENT ALL INST:COUP:FREQ:CENT?
<b>Preset</b>	Set to Off on Global Settings, Restore Defaults and System, Restore Defaults, All Modes
<b>Range</b>	On Off
Initial S/W Revision	Prior to A.02.00

<b>Remote Command</b>	:GLOBal:FREQuency:CENTer[:STATe] 1 0 ON OFF :GLOBal:FREQuency:CENTer[:STATe]?
Preset	Off
Initial S/W Revision	Prior to A.02.00

## Restore Defaults

This key resets all of the functions in the Global Settings menu to Off. This also occurs when System, Restore Defaults, All Modes is pressed.

Key Path	Mode Setup, Global Settings
<b>Remote Command</b>	:INSTrument:COUPle:DEFault
<b>Example</b>	INST:COUP:DEF
<b>Backwards Compatibility SCPI</b>	:GLOBal:DEFault
Initial S/W Revision	Prior to A.02.00

## Mode Setup

The Mode Setup menu contains setup functions that are global across the entire Mode. These functions are independent of which measurement is currently running – they are global to all measurements in the mode, or "Meas Global." The Mode Setup functions are not the only Meas Global functions in the analyzer; for example, the Trigger Setup functions are Meas Global, and there are even Mode Global functions (that is, the same for all Modes) in the Input/Output menu, but the fact that they are all Meas Global is a distinguishing characteristic of the Mode Setup functions.

The Mode Setup menu also contains the Restore Mode Defaults key. Most Meas Global functions are restored to their preset values by Mode Preset, however some variables are more persistent and are not preset until the Restore Mode Defaults key is pressed.

There are also a few Meas Global variables (for example, Global Center Frequency) that can be switched to be Mode Global, that is, the same for all modes. The keys under the Global Settings key control whether these variables are Mode Global or not.

In the Spectrum Analyzer mode, the Mode Setup functions include which radio standard and/or EMC standard is in use and how it is configured. A set of CISPR EMC presets is available as well.

The EMC keys require either the N6141A or W6141A application or Option EMC to be installed and licensed.

Key Path	Front-panel key
Initial S/W Revision	Prior to A.02.00

### EMC Standard

Accesses a menu that allows you to select None (no EMI standard), CISPR (CISPR 16–1–1), and MIL (MIL–461A). Each standard has a unique way of determining the couplings between detectors and RBWs, as well as its own set of available RBW's. The Filter Type is always Gaussian in EMI Receiver Mode.

Key Path	Mode Setup
<b>Remote Command</b>	[ :SENSe ] :EMC :STANdard [ :SElect ] NONE   CISPr   MIL [ :SENSe ] :EMC :STANdard [ :SElect ] ?
<b>Example</b>	EMC:STAN CISP EMC:STAN?
<b>Dependencies</b>	In Frequency Scan measurement, this key is grayed out when a scan sequence is running. If the grayed out key is pressed, an advisory message is generated. If the equivalent SCPI command is sent, this same message is generated as part of a “–221, Settings conflict” warning. In Frequency Scan measurement, EMC Standard None is grayed out during a Time Domain Scan. If the grayed out key is pressed, an advisory message is generated. If the equivalent SCPI command is sent, this same message is generated as part of a “–221, Settings conflict; Function not available with time domain scan type” warning.
<b>Couplings</b>	When the EMC Standard changes to None, the Filter Type is set to Gaussian and the Filter BW is set

	to -3 dB. Choosing a CISPR detector or CISPR presets automatically picks the CISPR Standard, however switching from a CISPR detector has no impact on EMC Standard. When EMC Standard set to CISPR, the default detector for meter 1 is Peak, meter 2 is Quasi Peak and EMI Average is the default detector for meter 3. When EMC Standard set to MIL, the default detector for meter 1 is Peak, meter 2 is Average and Negative Peak is the default detector for meter 3.
Preset	Reset to the value set in EMC Standard Preset To key.
State Saved	Saved in instrument state
Range	None CISPR MIL
Readback Text	None CISPR MIL
Initial S/W Revision	A.07.00

## Preset To

Enable you to choose which EMC Standard you want to Preset to.

Key Path	Mode Setup, EMC Std
<b>Remote Command</b>	[ :SENSe ] :EMC :STANdard :PRESet NONE   CISPr   MIL [ :SENSe ] :EMC :STANdard :PRESet ?
<b>Example</b>	:EMC:STAN:PRE\$ MIL
Preset	Not part of Preset, but is reset to CISPR by Restore Mode Defaults; survives a shutdown.
State Saved	Saved in instrument state
Range	None CISPR MIL
Readback Text	None CISPR MIL
Initial S/W Revision	A.10.00

## Mode IDN Response

Displays the menu keys that enable you to change the return string of the \*IDN? query, which will override the System IDN response. In all cases the default selection is “System IDN Response”, which means just use the response from the system.

The \*IDN string is in the format of <Manufacturer>, <Model>, <Serial Number>, <FW Version>. If R&S ESU or R&S ESL is selected, the IDN string will be in the format of Rohde&Schwarz,<Model>,000000/000,99.99, where <Model> depends on the instrument maximum frequency.

<b>Mode IDN Response</b>	<b>Freq Option of CXA, MXA, EXA, PXA and MXE</b>	<b>&lt;Model&gt; field of *IDN string</b>
--------------------------	--	---

R&S ESU	503, 507, 508, 513	ESU-8
	526	ESU-26
	550	ESU-40
R&S ESL	503	ESL-3
	507, 508, 513, 526, 550	ESL-6

Key Path	Mode Setup
Notes	Front panel only.
Preset	System IDN Response, not affected by Mode Preset, preset by Restore Mode Defaults.
State Saved	Saved in instrument state
Initial S/W Revision	A.07.00

## Meters Control

This key enables you to access settings for meters.

Key Path	Mode Setup
Initial S/W Revision	A.07.00

## Meters

Accesses a menu of functions that enable you set the meters' parameters.

Key Path	Mode Setup, Meters Control
Initial S/W Revision	A.07.00

## Select Meters

Specifies the selected meter. The term "selected meter" is used throughout this document to specify which meter will be affected by the functions. There are a total of three meters.

Key Path	Mode Setup, Meters Control, Meters
Notes	Front panel only. The selected meter is remembered even when not in the Meters Menu.
Preset	Meter 1, is not affected by a Mode Preset, but is preset by Restore Mode Defaults.
State Saved	Saved in instrument state
Initial S/W Revision	A.07.00



## Meter

Sets the state of the selected Meter. If the meter is turned on, the selected meter will be shown in the display and the measurement will be performed using the corresponded detector type. If it is off, it will be excluded from the display.

Key Path	Mode Setup, Meters Control, Meters
Remote Command	:DISPlay:MEter[1] 2 3[:STATe] ON OFF 0 1 :DISPlay:MEter[1] 2 3[:STATe]?
Example	DISP:MET2 1 Turn on Meter 2. DISP:MET2?
Notes	When Analog Out for Output Config is set to Screen Video/ Demod Audio, only Meter 1 will return the valid measurement result. Meter 2 & 3 will return -1000dBm if they are turned on.
Preset	ON OFF OFF
State Saved	Saved in instrument state
Range	On Off
Initial S/W Revision	A.07.00

## Detector (Meter)

Specifies the detector type for the selected meter.

Key Path	Mode Setup, Meters Control, Meters
Remote Command	[:SENSe]:MEter[1] 2 3:DEtector POSitive   QPEak   EAverage   RAverage   AVERage   NEGative [:SENSe]:MEter[1] 2 3:DEtector?
Example	MET3:DET EAV Set meter 3 to use EMI Average. MET3:DET?
Notes	When Tune & Listen is turned on, only Meter 1 will return the valid measurement result. Meter 2 & 3 will return -1000dBm. Meter 2 & 3 will return valid measurement results when Tune & Listen is turned off.
Dependencies	<p>If an EMI detector ( QPD or EMI Average or RMS Average) is already selected for two of the detectors, then the other EMI detector is grayed out. For example, if Detector 1 is QPD and Detector 2 is EMI Average, then for Detector 3, RMS Average is grayed out. If the grayed out key is pressed, an advisory message is generated. If the equivalent SCPI command is sent, this same message is generated as part of a “-221, Settings conflict” warning.</p> <p>Average detector and EMI detectors are mutually exclusive. If the Average detector is selected, the other three EMI Detectors are grayed out, and vice versa. If the grayed out key is pressed, an advisory message is generated. If the equivalent remote command is sent, this same message is generated as part of a “-221, Settings conflict” warning.</p> <p>When EMC Standard set to CISPR, the default detector for meter 1 is Peak, meter 2 is Quasi Peak and EMI Average is the default detector for meter 3.</p> <p>When EMC Standard set to MIL, the default detector for meter 1 is Peak, meter 2 is Average and Negative Peak is the default detector for meter 3.</p>

Couplings	Selecting a detector for a meter (pressing the key or sending a [:SENS]:MET:DET command) puts the meter in On, even if that detector was already selected. Voltage averaging will be used.
Preset	POSitive QPEak EAVerage
State Saved	Saved in instrument state
Range	Peak Quasi Peak EMI Average RMS Average Negative Peak
Initial S/W Revision	A.07.00

Key Path	Remote command only
Remote Command	:SENSe1 SENSe2 [SENSe]:DETEctor:RECEiver[:FUNction] POSitive   NEGative   RMS   AVERage   QPEak   CAVerage   CRMS,POSitive   NEGative   RMS   AVERage   QPEak   CAVerage   CRMS,POSitive   NEGative   RMS   AVERage   QPEak   CAVerage   CRMS :SENSe1 SENSe2 [SENSe]:DETEctor:RECEiver[:FUNction]?

Example	DET:REC AVER
---------	--------------

Notes

This command is included for ESU compatibility. The suffix [1]2 is irrelevant to the measurement, they are added solely for remote language compatibility.

This SCPI can receive up to 3 detector types, the detector types are separated by a comma. The 2nd and 3rd parameters in the command are optional. For example, for the case where two detectors are sent, the command will look like this DET:REC POS,QPE. The first detector refers to meter 1 detector, while the latter refers to meter 2 detector.

This command is alias to [:SENSe]:METer[1]2[3]:DETEctor <DectectorType>, :DISPlay:METer[1]2[3] [:STATe] ON.

POSitive	Peak
NEGative	Negative Peak
RMS/ CRMS	RMS Average
CAVerage	EMI Average
AVERage	Average
QPEak	Quasi Peak

The query will return the selected meter detector.  
CAV when EMI Average is selected.  
CRMS when RMS Average is selected.

Couplings	The number of detector parameters sent corresponds to the number of the meter being turned on, which means if there are 2 detector parameters sent, meter 1 and 2 will be turned on, and meter 3 will be turned off.
Preset	POSitive
Initial S/W Revision	A.07.00

## Limit

Enables you to set a limit value for meters.

<b>Key Path</b>	Mode Setup, Meters Control, Meters
<b>Remote Command</b>	:CALCulate:METER[1] 2 3:LIMit[:DATA] <ampl> :CALCulate:METER[1] 2 3:LIMit[:DATA]? :CALCulate:METER[1] 2 3:LIMit:STATe ON OFF 1 0 :CALCulate:METER[1] 2 3:LIMit:STATe?
<b>Example</b>	CALC:MET2:LIM 4dBuV Set the limit line of Meter 2 to 4 dBuV. :CALC:MET:LIM:STAT OFF ! Turns off the limit for Meter 1.
<b>Preset</b>	80 dBuV OFF
<b>State Saved</b>	Saved in instrument state.
<b>Min</b>	-250 dBuV
<b>Max</b>	250 dBuV
<b>Default Unit</b>	Depends on the current selected Y axis unit
<b>Initial S/W Revision</b>	A.07.00

### Limit Fail? (Remote Command Only)

Tests a limit line against its associated meter. Returns a 0 if the meter is within the limit, a 1 if the meter exceeds either limit.

Note that this command only tests one limit line – other limit lines are not tested when executing this command. To see whether meters passed all limits, use :CALCulate:METER:LIMit:ALL:FAIL?.

Note that this command performs the test regardless of whether the meter or the limit is turned on, on the display.

<b>Key Path</b>	Remote command only
<b>Remote Command</b>	:CALCulate:METER[1] 2 3:LIMit:FAIL?
<b>Example</b>	CALC:MET:LIM:FAIL? Returns a zero if limit line 1's associated meter is within limit, 1 if the associated meter failed the limit.
<b>Initial S/W Revision</b>	A.07.00

### All Limit Fail? (Remote Command Only)

Tests all limit lines of meters. Returns 0 if all meters are within the limit, otherwise returns 1. If no limits apply to meters, this query will return a 0.

Only applies to meters that have limits turned on, if a Limit is off, it will not be tested.

Key Path	Remote command only
<b>Remote Command</b>	:CALCulate:METer:LIMit:ALL:FAIL?
<b>Example</b>	CALC:MET:LIM:ALL:FAIL?
Initial S/W Revision	A.07.00

### Current Power (Remote Query Only)

Queries the current power of meters in the currently selected amplitude unit. Returns the minimum data value if the meter is off.

Key Path	Remote command only
<b>Remote Command</b>	:CALCulate:METer:POWer[:CURRent]?
<b>Example</b>	CALC:MET:POW?
Notes	This query returns the current power values for all three meters separated by commas.
Initial S/W Revision	A.07.00

### Peak Power (Remote Query Only)

Query peak power of meters in the currently selected amplitude unit. Returns the minimum data value if meter is off.

Key Path	Remote command only
<b>Remote Command</b>	:CALCulate:METer:POWer:PEAK?
<b>Example</b>	CALC:MET:POW:PEAK?
Notes	This query returns peak power values for all three meters separated by commas.
Initial S/W Revision	A.07.00

### Dwell Time (per point)

Specifies the dwell time for the meter's detectors.

Key Path	Mode Setup, Meters Control
<b>Remote Command</b>	[[:SENSe]:METer:DETEctor:DWELl <time> [:SENSe]:METer:DETEctor:DWELl?
<b>Example</b>	MET:DET:DWEL 500ms MET:DET:DWEL?
Preset	10 ms
State Saved	Saved in instrument state.
Min	10 ms

Max	100 s
Default Unit	s
<b>Backwards Compatibility SCPI</b>	:SENSe1   SENSe2   [SENSe] :SWEep:TIME
Backwards Compatibility SCPI Notes	This command above is included for ESU compatibility. The suffix 1 2 is irrelevant to the measurement, they are added solely for remote language compatibility.
Initial S/W Revision	A.07.00

## Peak Hold Time

Accesses a menu that lets you set the peak hold time of the meters. If set to Adjustable, the max hold line and max result of the meters will be reset for each due of a peak hold time. If set to infinite, the max hold line and max result would not be reset.

Key Path	Mode Setup, Meters Control
<b>Remote Command</b>	[ :SENSe ] :METer:PHOLd:TYPE INFinite ADJustable [ :SENSe ] :METer:PHOLd:TYPE?
<b>Example</b>	MET:PHOL:TYPE INF MET:PHOL:TYPE?
Preset	INFinite
State Saved	Saved in instrument state
Range	Adjustable Infinite
Initial S/W Revision	A.07.00

## Adjustable

Sets the Peak Hold Time to Adjustable.

Key Path	Mode Setup, Meters Control, Peak Hold Time
<b>Example</b>	MET:PHOL:TYPE ADJ
Readback Text	<time>
Initial S/W Revision	A.07.00

Key Path	Mode Setup, Meters Control, Peak Hold Time
<b>Remote Command</b>	[ :SENSe ] :METer:PHOLd:ADJustable <time> [ :SENSe ] :METer:PHOLd:ADJustable?
<b>Example</b>	MET:PHOL:ADJ 500 ms MET:PHOL:ADJ?

Preset	2 s
State Saved	Saved in instrument state
Min	0.5 s
Max	1000 s
Default Unit	s
Initial S/W Revision	A.07.00

### Infinite

Sets the Peak Hold Time to Infinite.

Key Path	Mode Setup, Meters Control, Peak Hold Time
<b>Example</b>	MET:PHOL:TYPE INF
Readback Text	Infinite
Initial S/W Revision	A.07.00

### Reset Peak Hold

Resets the peak hold line for all meters that are turned ON to the current signal value.

Key Path	Mode Setup, Meters Control
<b>Remote Command</b>	[ :SENSE ] :METer :PHOLd :RESet
<b>Example</b>	MET:PHOL:RES
Initial S/W Revision	A.07.00

### Autorange

Accesses a menu that lets you choose whether or not to turn on the Autorange feature for meter and Strip Chart.

Key Path	Mode Setup, Meters Control
Readback	In square brackets, the state of Autorange then the state of Auto Preamp, separated by commas, as [Rng:On, Pre:Off]
Initial S/W Revision	A.10.00

### Autorange

When autorange is selected, the attenuation will be increased automatically when an overload is detected for meter and Strip Chart.

Key Path	Mode Setup, Meters Control, Autorange
<b>Remote Command</b>	[ :SENSe ] :METer:ATTenuation:AUTO ON OFF 1 0 [ :SENSe ] :METer:ATTenuation:AUTO?
<b>Example</b>	:MET:ATT:AUTO 0 :MET:ATT:AUTO?
Preset	OFF
State Saved	Saved in instrument state
<b>Backwards Compatibility SCPI</b>	INPut [1]   2 :ATTenuation:AUTO
Backwards Compatibility SCPI Notes	This command above is included for ESU compatibility. The suffix [1] 2 are irrelevant to the measurement, they are added solely for remote language compatibility.
Initial S/W Revision	A.10.00

### Auto Preamp

When ON, Int Premp will be considered in the autorange procedure for meters and Strip Chart.

Key Path	Mode Setup, Meters Control, Autorange
<b>Remote Command</b>	[ :SENSe ] :METer:GAIN:AUTO ON OFF 1 0 [ :SENSe ] :METer:GAIN:AUTO?
<b>Example</b>	:MET:GAIN:AUTO ON :MET:GAIN:AUTO?
Preset	OFF
State Saved	Saved in instrument state
<b>Backwards Compatibility SCPI</b>	INPut [1]   2 :GAIN:AUTO ON   OFF
Backwards Compatibility SCPI Notes	This command above is included for ESU compatibility. The suffix [1] 2 are irrelevant to the measurement, they are added solely for remote language compatibility.
Initial S/W Revision	A.10.00

### Couple Meters to Signal List

This key is only available when in the Frequency Scan measurement. If this is turned on, the measurement will automatically couple Frequency (Meters) to the Frequency of the selected signal when the selected signal is changed.

Key Path	Mode Setup, Meters Control
<b>Remote Command</b>	[ :SENSe ] :FSCan:SLISt:COUPle:METer ON OFF 1 0 [ :SENSe ] :FSCan:SLISt:COUPle:METer?
<b>Example</b>	SENS:FSC:SLIS:COUP:MET 1 Couple Meters to Signal List

	SENS:FSC:SLIS:COUP:MET?
Couplings	Couple Meters to Marker key will be turned off when this key is turned on.
Preset	ON
State Saved	Saved in instrument state.
Range	On Off
Initial S/W Revision	A.07.00

### Couple Meters to Marker

If this is turned on, the measurement will automatically couple Meters frequency to frequency of the selected marker.

Key Path	Marker
<b>Remote Command</b>	:CALCulate:FSCan:MARKer:COUPle:METer ON OFF 1 0 :CALCulate:FSCan:MARKer:COUPle:METer?
<b>Example</b>	CALC:FSC:MARK:COUP:MET 1 CALC:FSC:MARK:COUP:MET?
Couplings	Couple Meters to Signal List key will be turned off when this key is turned on.
Preset	OFF
State Saved	Saved in instrument state.
Range	On Off
<b>Backwards Compatibility SCPI</b>	:CALCulate[1] 2:MARKer:COUPled[:STATE] ON OFF 1 0 :CALCulate[1] 2:MARKer:COUPled[:STATE]?
Initial S/W Revision	A.13.00

### Autorange Atten 10 dB Minimum

Toggles the autorange attenuation protection to have at least 10 dB always set on the input.

Key Path	Mode Setup
<b>Remote Command</b>	[:SENSe]:METer:ATTenuation:PROTection ON OFF 1 0 [:SENSe]:METer:ATTenuation:PROTection?
<b>Example</b>	MET:ATT:PROT ON MET:ATT:PROT?
Couplings	When ON, an attenuation of at least 10 dB is always set on the input when autorange is running during meters measurement, prescan and the final measurement.
Preset	OFF
State Saved	Saved in instrument state
<b>Backwards</b>	:INPut[1] 2:ATTenuation:PROTection



<b>Compatibility SCPI</b>	<code>[ :SENSE ] :FSCan:FINal:ATTenuation:PROTection</code>
Backwards Compatibility SCPI Notes	This command above is included for ESU compatibility. The suffix [1]2 is irrelevant to the measurement, they are added solely for remote language compatibility.
Initial S/W Revision	A.10.00

## Noise Reduction

Noise Reduction accesses a menu for configuring the noise compensation of the instrument. This menu only appears in models that support Noise Reduction.

Key Path	Mode Setup
Initial S/W Revision	A.04.00

## Noise Floor Extension

Turns on the Noise Floor Extension function. When this function is On, the expected noise power of the analyzer (derived from a factory calibration) is subtracted from the trace data. This will usually reduce the apparent noise level by about 10 dB in low band, and 8 dB in high band (>~3.6 GHz).

Noise Floor Extension works with any RBW, VBW, detector, any setting of Average Type, any amount of trace averaging, and any signal type. It is ineffective when the trace is not smoothed (smoothing processes include narrow VBWs, trace averaging, and long sweep times with the detector set to Average or Peak). It works best with extreme amounts of smoothing, and with the average detector, with the Average Type set to Power.

### NOTE

Noise Floor Extensions has no effect unless the RF Input is selected, therefore it does nothing when External Mixing is selected.

In those cases where the cancellation is ineffective, it nonetheless has no undesirable side-effects. There is no significant speed impact to having Noise Floor Extension on.

The best accuracy is achieved when substantial smoothing occurs in each point before trace averaging. Thus, when using the average detector, results are better with long sweep times and fewer trace averages. When using the sample detector, the VBW filter should be set narrow with less trace averaging, instead of a wide VBW filter with more trace averaging.

See "[More Information](#)" on page 258

Key Path	Mode Setup, Noise Reduction
Scope	Meas Global
Remote Command	<code>[ :SENSE ] :CORRection:NOISe:FLOor ON OFF 1 0</code> <code>[ :SENSE ] :CORRection:NOISe:FLOor?</code>
Example	<code>CORR:NOIS:FLO ON</code>
Dependencies	This key only appears in instruments with the NFE or NF2 license installed. In all others, the key does not appear, however the SCPI command will be accepted without error (but will have no effect).

Couplings	When NFE is enabled in any mode manually, a prompt will be displayed reminding you to perform the Characterize Noise Floor operation if it is needed. If NFE is enabled through SCPI and a Characterize Noise Floor operation is needed, an error will be entered in the system error queue.
Preset	Unaffected by Mode Preset. Turned off by Restore Mode Defaults.
State Saved	No
Initial S/W Revision	A.04.00

## More Information

The analyzer is characterized in the factory (or during a field calibration) with a model of the noise, referred to the input mixer, versus frequency in each band and path combination. Bands are 0 (low band) and 1 through 4 (high band) in a 26.5 GHz instrument, for example. Paths include normal paths, preamp paths, the electronic attenuator, etc.

In most band/path combinations, the noise can be well characterized based on just two parameters and the analyzer frequency response before compensation for frequency-dependent losses.

After the noise density at the input mixer is estimated, the effects of the input attenuator, RBW, detector, etc. are computed to get the estimated input-port-referred noise level.

In the simplest case, the measured power (signal plus analyzer noise) in each display point (bucket) is compensated by subtracting the estimated noise power, leaving just the signal power. This is the operation when the detector is Average and the Average Type is set to Power.

In other cases, operation is often not quite as good but still highly effective. With peak detection, the noise floor is estimated based on the RBW and the duration of the bucket using the same equations used in the noise marker function. The voltage of the noise is subtracted from the voltage of the observed signal-plus-noise measurement to compute the estimated signal voltage. The peak detector is one example of processing that varies with detector to give good estimates of the signal level without the analyzer noise.

For best operation, the average detector and the power scale are recommended, as already stated. Peak detection for pulsed-RF can still give excellent effectiveness. FFT analysis does not work well, and does not do NFE well, with pulsed-RF signals, so this combination is not recommended. Negative peak detection is not very useful, either. Sample detection works well, but is never better than the average detector because it doesn't smooth as well. The Normal detector is a combination of peak and negative peak behaviors, and works about as well as these.

For best operation, extreme smoothing is desirable, as already stated. Using narrow VBWs works well, but using very long bucket durations and the average detector works best. Reducing the number of trace points will make the buckets longer.

For best operation, the power scale (Average Type = Power) is optimum. When making CW measurements in the presence of noise without NFE, averaging on the decibel scale has the advantage of reducing the effect of noise. When using NFE, the NFE does an even better job than using the log scale ever could. Using NFE with the log scale is not synergistic, though; NFE with the power scale works a little better than NFE with log averaging type.

The results from NFE with internal preamp can often be lower than the theoretical noise in a signal source at room temperature, a noise density of  $-174$  dBm/Hz. This is expected and useful behavior, because NFE

is designed to report the amount of input signal that is in excess of the thermal noise, not the amount that includes the thermal noise. This can be a useful behavior because thermal noise often interferes with what you want to measure, instead of being part of what you want to measure. Note that NFE is not adequately accurate to always be able to read below kTB.

On instruments with the NF2 license installed, the calibrated Noise Floor used by Noise Floor Extensions should be refreshed periodically. Agilent recommends that the Characterize Noise Floor operation be performed after the first 500 hours of operation, and once every calendar year. The key to perform this is located in the System, Alignments, Advanced menu. If you have not done this yourself at the recommended interval, then when you turn on Noise Floor Extensions, the analyzer will prompt you to do so with a dialog that says:

“This action will take several minutes to perform. Please disconnect all cables from the RF input and press Enter to proceed. Press ESC to cancel, or Postpone to postpone for a week.”

If you Cancel, you will be prompted again the next time you turn NFE on. If you postpone, you will be prompted again after a week passes and you then turn NFE on.

## Global Settings

Opens a menu that allows you to switch certain Meas Global parameters to a Mode Global state.

Key Path	Mode Setup
Initial S/W Revision	A.07.00

## Global Center Freq

When the EMI Receiver mode chooses the mode global CF behavior, the Center Frequency value is maintained when entering the EMI Receiver mode from any other mode that supports Global Center Freq.

When the EMI Receiver mode chooses to not use the mode global CF, the default CF is 515 MHz upon entering EMI Receiver mode.

Key Path	Mode Setup, Global Settings
Initial S/W Revision	A.07.00

## Global EMC Std

When the Global EMC Std key is switched to On in any mode, the current mode's EMC Std is copied into the Global EMC Std, and from then on all modes that support global settings use the Global EMC Std. So you can switch between any of these modes and the EMC Std will remain unchanged.

Adjusting the EMC Std of any mode that supports Global Settings, while Global EMC Std is On, will modify the Global EMC Std.

When Global EMC Std is turned Off, the EMC Std of the current mode is unchanged, but now the EMC Std of each mode is once again independent. When Mode Preset is pressed while Global EMC Std is On, the Global EMC Std is preset to the preset EMC Std of the current mode.

This function is reset to Off when the Restore Defaults key is pressed in the Global Settings menu, or when System, Restore Defaults, All Modes is pressed.

Key Path	Mode Setup, Global Settings
Scope	Mode Global
Remote Command	:INSTrument:COUPle:EMC:STANdard ALL NONE :INSTrument:COUPle:EMC:STANdard?
Example	INST:COUP:EMC:STAN ALL INST:COUP:EMC:STAN?
Preset	Set to Off on Global Settings, Restore Defaults and System, Restore Defaults, All Modes
Range	On Off
Initial S/W Revision	A.07.00

### Restore Defaults

This key resets all of the functions in the Global Settings menu to off. See ["Restore Defaults" on page 245](#) for more details.

Key Path	Mode Setup, Global Settings
Initial S/W Revision	A.07.00

### LISN Control

This menu enables you to access LISN related functions. LISN control is only available in the MXE with option LSN indicating that the LISN IO board is installed. Otherwise, the key will not be shown.

Key Path	Mode Setup
Initial S/W Revision	A.13.50

### V-network

Enables you to select the V-network that is controlled via the AUX IO port.

Key Path	Mode Setup, LISN Control
Remote Command	INPut [1]   2:LISN[:TYPE] FOURphase ESH2Z5  ENV216   OFF INPut [1]   2:LISN[:TYPE] ?
Example	:INP:LISN FOUR
Notes	FOURPhase and ESH2-Z5 R&S ESH2-Z5 (four phases and protective earth are controllable) ENV216 R&S ENV216 (two phases and highpass are controllable)

	OFF Remote control deactivated This query will return :- FOUR when ESH2-Z5 is selected.
Preset	Set to off on a "Restore Input/Output Defaults"
State Saved	Saved in instrument state
Initial S/W Revision	A.13.50

## Phase

This command enables you to select the phase of the V-network that is used, which is controlled via the AUX IO port. The permissible selection depends on the selected V-network.

Key Path	Mode Setup, LISN Control, ESH2Z5/ENV216
<b>Remote Command</b>	INPut [1]   2 : LISN : PHASe L1   L2   L3   N INPut [1]   2 : LISN : PHASe?
<b>Example</b>	:INP:LISN:PHAS L1
Couplings	Phase N L1 L2 L3 are grayed out with OFF whereas Phase L2 L3 are grayed out with ENV216. If the grayed out key is pressed, an advisory message is generated. If the equivalent SCPI command is sent, this same message is generated as part of a “-221, Setting Conflict; Function not available with current LISN Type” warning.
Preset	Set to N on a "Restore Input/Output Defaults"
State Saved	Saved in instrument state
Range	Phase N Phase L1 Phase L2 Phase L3 Only one phase can be selected.
Initial S/W Revision	A.13.50

## Protective Earth

Enables you to set the Protective Earth setting that is controlled via the AUX IO port.

Key Path	Mode Setup, LISN Control, ESH2Z5
<b>Remote Command</b>	INPut [1]   2 : LISN : PEARth GROunded   FLOating INPut [1]   2 : LISN : PEARth?
<b>Example</b>	:INP:LISN:PEAR GRO
Dependencies	This key is grayed out when V-network other than ESH2Z5 is selected. If the grayed out key is pressed, an advisory message is generated. If the equivalent SCPI command is sent, this same message is generated as part of a “-221, Setting Conflict; Function not available with current LISN Type” warning.
Preset	Set to GRO on a "Restore Input/Output Defaults"

State Saved	Saved in instrument state
Range	GRO FLO
Initial S/W Revision	A.13.50

## V-network

Enables you to select the V-network that is controlled via the AUX IO port.

Key Path	Mode Setup, LISN Control
<b>Remote Command</b>	INPut [1]   2:LISN[:TYPE] FOURphase ESH2Z5  ENV216   OFF INPut [1]   2:LISN[:TYPE] ?
<b>Example</b>	:INP:LISN FOUR
Notes	FOURPhase and ESH2-Z5 R&S ESH2-Z5 (four phases and protective earth are controllable) ENV216 R&S ENV216 (two phases and highpass are controllable) OFF Remote control deactivated This query will return :- FOUR when ESH2-Z5 is selected.
Preset	Set to off on a "Restore Input/Output Defaults"
State Saved	Saved in instrument state
Initial S/W Revision	A.13.50

## Phase

This command enables you to select the phase of the V-network that is used, which is controlled via the AUX IO port. The permissible selection depends on the selected V-network.

Key Path	Mode Setup, LISN Control, ESH2Z5/ENV216
<b>Remote Command</b>	INPut [1]   2:LISN:PHASe L1 L2 L3 N INPut [1]   2:LISN:PHASe ?
<b>Example</b>	:INP:LISN:PHAS L1
Couplings	Phase N L1 L2 L3 are grayed out with OFF whereas Phase L2 L3 are grayed out with ENV216. If the grayed out key is pressed, an advisory message is generated. If the equivalent SCPI command is sent, this same message is generated as part of a “-221, Setting Conflict; Function not available with current LISN Type” warning.
Preset	Set to N on a "Restore Input/Output Defaults"
State Saved	Saved in instrument state
Range	Phase N Phase L1 Phase L2 Phase L3

	Only one phase can be selected.
Initial S/W Revision	A.13.50

## 150 kHz Highpass

Controls highpass setting on the V-network.

Key Path	Mode Setup, LISN Control, ENV216
<b>Remote Command</b>	INPut [1]   2:LISN:FILTer:HPAS[:STATe] ON OFF 1 0 INPut [1]   2:LISN:FILTer:HPAS[:STATe] ?
<b>Example</b>	:INP:LISN:FILT:HPAS ON
Dependencies	This key is grayed out when V-network other than ENV216 is selected. If the grayed out key is pressed, an advisory message is generated. If the equivalent SCPI command is sent, this same message is generated as part of a “-221, Setting Conflict; Function not available with current LISN Type” warning.
Couplings	This key is coupled to 150kHz Highpass of Frequency Scan Measurement’s LISN Control (Measure), and vice versa.
Preset	Set to off on a "Restore Input/Output Defaults"
State Saved	Saved in instrument state
Range	ON OFF
Initial S/W Revision	A.13.50

## V-network

Enables you to select the V-network that is controlled via the AUX IO port.

Key Path	Mode Setup, LISN Control
<b>Remote Command</b>	INPut [1]   2:LISN[:TYPE] FOURphase ESH2Z5  ENV216   OFF INPut [1]   2:LISN[:TYPE] ?
<b>Example</b>	:INP:LISN FOUR
Notes	FOURPhase and ESH2-Z5 R&S ESH2-Z5 (four phases and protective earth are controllable) ENV216 R&S ENV216 (two phases and highpass are controllable) OFF Remote control deactivated This query will return :- FOUR when ESH2-Z5 is selected.
Preset	Set to off on a "Restore Input/Output Defaults"
State Saved	Saved in instrument state
Initial S/W Revision	A.13.50

## Restore Mode Defaults

Resets the state for the currently active mode by resetting the mode persistent settings to their factory default values, clearing mode data and by performing a Mode Preset.

See [Restore Mode Defaults](#) for more information.

Key Path	Mode Setup
Initial S/W Revision	A.07.00



## 6 System Functions

## File

Opens a menu that enables you to access various standard and custom Windows functions. Press any other front-panel key to exit

Key Path	Front-panel key
Initial S/W Revision	Prior to A.02.00

## File Explorer

Opens the standard Windows File Explorer. The File Explorer opens in the My Documents directory for the current user.

The File Explorer is a separate Windows application, so to return to the analyzer once you are in the File Explorer, you may either:

Exit the File Explorer by clicking on the red X in the upper right corner, with a mouse

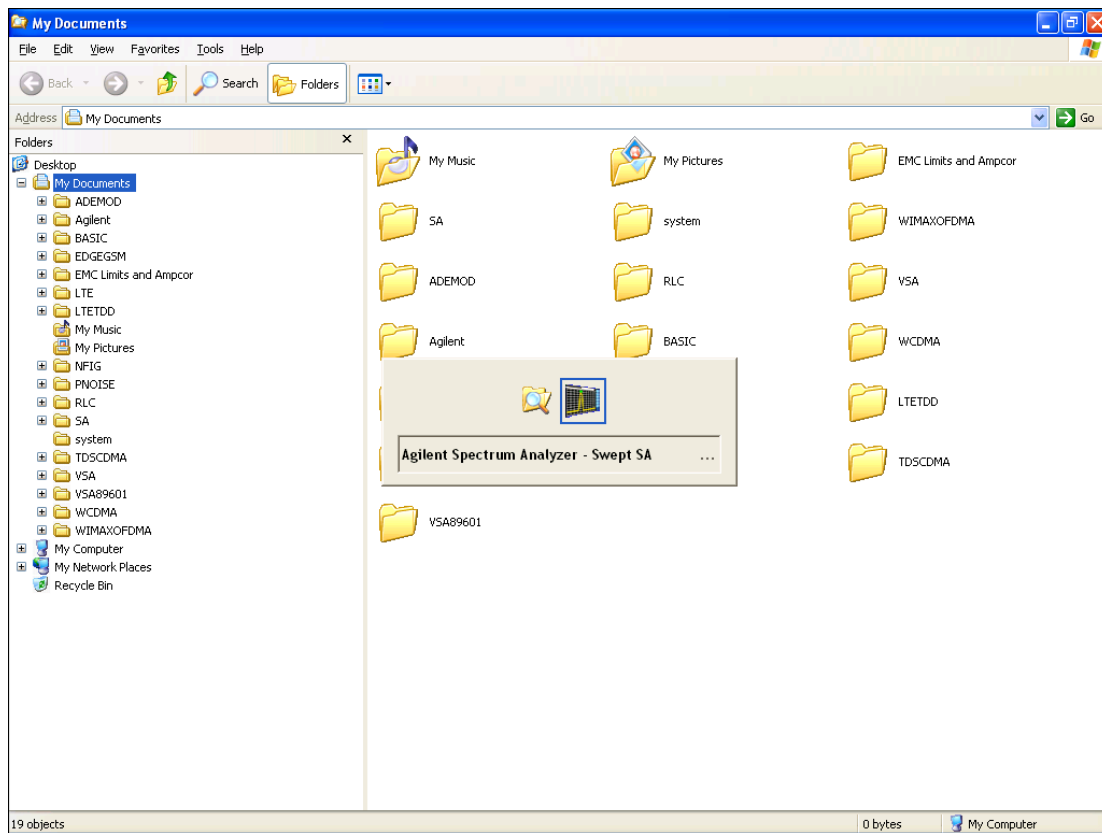

Or use Alt-Tab: press and hold the Alt key and press and release the Tab key until the Analyzer logo is showing in the window in the center of the screen, as shown above, then release the Alt key.

The ability to access File Explorer is not available if Option SF1 is installed.

Key Path	File
Initial S/W Revision	Prior to A.02.00

## Print

The Print key opens a Print dialog for configured printing (for example, to the printer of your choice). Refer to your Microsoft Windows Operating System manual for more information.

## Maximize/Restore Down

These keys allow the Instrument Application to be maximized and then restored to its prior state. Only one of the two keys is visible at a time. When not already maximized the Maximize Application key is visible, and when maximized, the Restore Down Application key is visible and replaces the Maximize Application key.

### Maximize

This key allows you to Maximize the Instrument Application, which causes the analyzer display to fill the screen. Once the application is maximized, this key is replaced by the Restore Down key.

Key Path	File
Mode	All
Notes	No equivalent remote command for this key.
State Saved	No
Initial S/W Revision	A.05.01

### Restore Down

This key allows you to Restore Down the Instrument Application and reverses the action taken by Maximize. This key is only visible when the application has been maximized, and after the Restore Down action has been completed this key is replaced by the Maximize key.

Key Path	File
Mode	All
Notes	No equivalent remote command for this key.
State Saved	No
Initial S/W Revision	A.05.01

## Page Setup

The Page Setup key brings up a Windows Page Setup dialog that allows you to control aspects of the pages sent to the printer when the PRINT hardkey is pressed.

Key Path	File
Initial S/W Revision	Prior to A.02.00

Paper size, the printer paper source, the page orientation and the margins are all settable. Just like any standard Windows dialog, you may navigate the dialog using the front-panel keys, or a mouse. There are no SCPI commands for controlling these parameters.

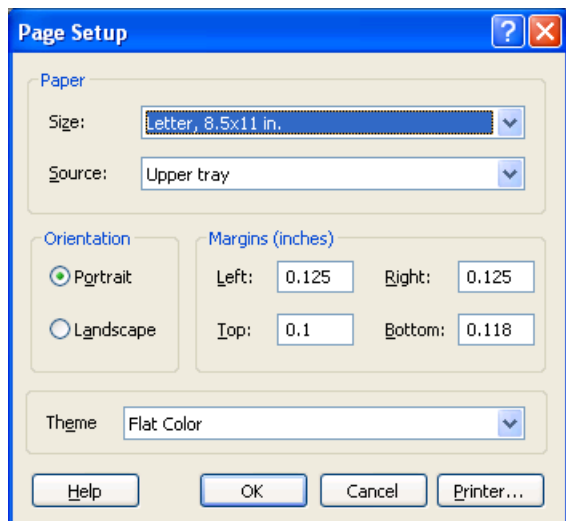

Also contained in this dialog is a drop-down control that lets you select the Theme to use when printing. For more on Themes, see information under View/Display, Display, System Display Settings, Theme. The Theme control has a corresponding SCPI command.

Parameter Name	Print Themes
Parameter Type	Enum
Mode	All
Remote Command	:SYSTEM:PRINT:THEME TDCOLOR TDMONOCHROME FCOLOR FMONOCHROME :SYSTEM:PRINT:THEME?
Example	:SYST:PRIN:THEM FCOL
Setup	:SYSTem:DEFault MISC
Preset	FCOL; not part of Preset, but is reset by Restore Misc Defaults or Restore System Defaults All and survives subsequent running of the modes.
State Saved	No
Initial S/W Revision	Prior to A.02.00

## Print

This front-panel key is equivalent to performing a File, Print, OK. It immediately performs the currently configured Print to the Default printer.

The :HCOPY command is equivalent to pressing the PRINT key. The HCOPY:ABORT command can be used to abort a print which is already in progress. Sending HCOPY:ABORT will cause the analyzer to stop sending data to the printer, although the printer may continue or even complete the print, depending on how much data was sent to the printer before the user sent the ABORT command.

Key Path	Front-panel key
<b>Remote Command</b>	:HCOPY[:IMMEDIATE]
Initial S/W Revision	Prior to A.02.00

Key Path	SCPI command only
<b>Remote Command</b>	:HCOPY:ABORT
Initial S/W Revision	Prior to A.02.00

## Restore Down

This key allows you to Restore Down the Instrument Application and reverses the action taken by Maximize. This key is only visible when the application has been maximized, and after the Restore Down action has been completed this key is replaced by the Maximize key.

Key Path	File
Mode	All
Notes	No equivalent remote command for this key.
State Saved	No
Initial S/W Revision	A.05.01

## Minimize

The Minimize key causes the analyzer display to disappear down into the task bar, allowing you to see the

Windows Desktop. You can use Alt-Tab (press and hold the Alt  key and press and release the Tab key) to restore the analyzer display.

Key Path	File
Mode	All
Notes	No equivalent remote command for this key.
State Saved	No
Initial S/W Revision	A.05.01

## Exit

This key, when pressed, will exit the Instrument Application. A dialog box is used to confirm that you intended to exit the application:

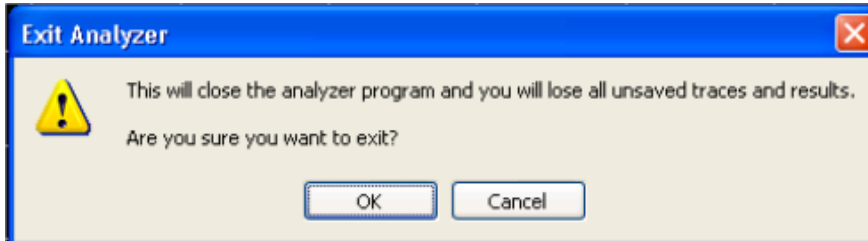

---

Key Path	File
Mode	All
Notes	The Instrument Application will close. No further SCPI commands can be sent. Use with caution!
Initial S/W Revision	Prior to A.02.00

---

## Print

This front-panel key is equivalent to performing a File, Print, OK. It immediately performs the currently configured Print to the Default printer.

The :HCOPY command is equivalent to pressing the PRINT key. The HCOPY:ABORT command can be used to abort a print which is already in progress. Sending HCOPY:ABORT will cause the analyzer to stop sending data to the printer, although the printer may continue or even complete the print, depending on how much data was sent to the printer before the user sent the ABORT command.

---

Key Path	Front-panel key
<b>Remote Command</b>	:HCOPY[:IMMEDIATE]
Initial S/W Revision	Prior to A.02.00

---

---

Key Path	SCPI command only
<b>Remote Command</b>	:HCOPY:ABORT
Initial S/W Revision	Prior to A.02.00

---

## System

Opens a menu of keys that access various configuration menus and dialogs.

Key Path	Front-panel key
Notes	No remote command for this key specifically.
Initial S/W Revision	Prior to A.02.00

## Show

Accesses a menu of choices that enable you to select the information window you want to view.

Key Path	System
Mode	All
Remote Command	:SYSTem:SHOW OFF   ERRor   SYSTem   HARDware   LXI   HWSTatistics   ALIGNment   SOFTware   CAPplication :SYSTem:SHOW?
Example	:SYST:SHOW SYST
Notes	This command displays (or exits) the various System information screens.
Preset	OFF
State Saved	No
Range	OFF  ERRor   SYSTem   HARDware   LXI   HWSTatistics   ALIGNment   SOFTware CAPplication
Initial S/W Revision	Prior to A.02.00

## Errors

There are two modes for the Errors selection, History and Status.

The list of errors displayed in the Errors screen does not automatically refresh. You must press the Refresh key or leave the screen and return to it to refresh it.

History brings up a screen displaying the event log in chronological order, with the newest event at the top. The history queue can hold up to 100 messages (if a message has a repeat count greater than 1 it only counts once against this number of 100). Note that this count bears no relation to the size of the SCPI queue. If the queue extends onto a second page, a scroll bar appears to allow scrolling with a mouse. Time is displayed to the second.

Status brings up a screen summarizing the status conditions currently in effect. Note that the time is displayed to the second.

The fields on the Errors display are:

Type (unlabeled) - Displays the icon identifying the event or condition as an error or warning.

ID - Displays the error number.

Message - Displays the message text.



Repeat (RPT) - This field shows the number of consecutive instances of the event, uninterrupted by other events. If an event occurs 5 times with no other intervening event, the value of repeat will be 5.

If the value of Repeat is 1 the field does not display. If the value of Repeat is >1, the time and date shown are those of the most recent occurrence. If the value of repeat reaches 999,999 it stops there.

Time - Shows the most recent time (including the date) at which the event occurred.

Key Path	System, Show
Mode	All
Remote Command	:SYSTem:ERRor[:NEXT]?
Example	:SYST:ERR?
Notes	The return string has the format: “<Error Number>,<Error>” Where <Error Number> and <Error> are those shown on the Show Errors screen
Backwards Compatibility Notes	In some legacy analyzers, the Repeat field shows the number of times the message has repeated since the last time the error queue was cleared. In the X-Series, the Repeat field shows the number of times the error has repeated since the last intervening error. So the count may very well be different than in the past even for identical signal conditions  Unlike previous analyzers, in the X-Series all errors are reported through the Message or Status lines and are logged to the event queue. They never appear as text in the graticule area (as they sometimes do in previous analyzers) and they are never displayed in the settings panel at the top of the screen (as they sometimes do, by changing color, in previous analyzers).  As a consequence of the above, the user can only see one status condition (the most recently generated) without looking at the queue. In the past, at least in the Spectrum Analyzer, multiple status conditions might display on the right side of the graticule.  In general, there is no backwards compatibility specified or guaranteed between the error numbers in the X-Series and those of earlier products. Error, event, and status processing code in customers' software will probably need to be rewritten to work with X-Series.  In the legacy analyzers, some conditions report as errors and others simply turn on status bits. Conditions that report as errors often report over and over as long as the condition exists. In the X-series, all conditions report as start and stop events. Consequently, software that repeatedly queries for a condition error until it stops reporting will have to be rewritten for the X-series.
Initial S/W Revision	Prior to A.02.00

## Previous Page

See ["Next Page" on page 274.](#)

Key Path	System, Show, Errors
Initial S/W Revision	Prior to A.02.00

## Next Page

Next Page and Previous Page menu keys move you between pages of the log, if it fills more than one page. These keys are grayed out in some cases:

- If on the last page of the log, the Next Page key is grayed-out
- If on the first page of the log, the Previous Page key is grayed-out.
- If there is only one page, both keys are grayed out.

Key Path	System, Show, Errors
Initial S/W Revision	Prior to A.02.00

## History

The History and Status keys select the Errors view. The Status key has a second line that shows a number in [square brackets]. This is the number of currently open status items.

Key Path	System, Show, Errors
Initial S/W Revision	Prior to A.02.00

## Verbose SCPI On/Off

When you turn Verbose SCPI on, additional information is returned when you send the :SYSTem:ERRor? query. The additional information consists of the characters that stimulated the error. This can aid you in debugging your test programs by indicating where in the parsing of a SCPI command the instrument encountered an invalid command or query.

Specifically, with Verbose SCPI on, the SYSTem:ERRor? query is expanded to show the SCPI data received, with the indicator <Err> at the point in the stream that the error occurred.

Verbose SCPI has no effect on the Show Errors screen or front panel Message Line; it only changes the response to the :SYST:ERR? query.

See the example below, where the invalid command "SENS:BOGUS" is sent:

Normal response to :SYST:ERR (using the Telnet window):

```
SCPI> SENS:BOGUS
```

```
SCPI> SYST:ERR?
```

```
-113,"Undefined header"
```

Now after turning on Verbose SCPI:

```
SCPI> SYST:BOGUS
```

```
SCPI> SYST:ERR?
```

```
-113,"Undefined header;SYST:BOGUS<Err>"
```

Key Path	System, Show, Errors
Mode	All
<b>Remote Command</b>	:SYSTem:ERRor:VERBose OFF ON 0 1 :SYSTem:ERRor:VERBose?
<b>Example</b>	:SYST:ERR:VERB ON
Preset	This is unaffected by Preset but is set to OFF on a "Restore System Defaults->Misc"
State Saved	No
Range	On   Off
Initial S/W Revision	Prior to A.02.00

### Refresh

When pressed, refreshes the Show Errors display.

Key Path	System, Show, Errors
Initial S/W Revision	Prior to A.02.00

### Clear Error Queue

This clears all errors in all error queues.

Note the following:

- Clear Error Queue does not affect the current status conditions.
- Mode Preset does not clear the error queue.
- Restore System Defaults will clear all error queues.
- \*CLS only clears the queue if it is sent remotely and \*RST does not affect any error queue.
- Switching modes does not affect any error queues.

Key Path	System, Show, Errors
Initial S/W Revision	Prior to A.02.00

### Status

See "[History](#)" on page 274.

### Input Overload Enable (Remote Command Only)

Input Overload errors are reported using the Input Overload status bit (bit 12 in the Measurement Integrity status register). Input Overloads (for example, ADC Overload errors) can come and go with great frequency, generating many error events (for example, for signals just on the verge of overload), and so are

not put into the SCPI error queue by default. Normally the status bit is the only way for detecting these errors remotely.

It is possible to enable Input Overload reporting to the SCPI queue, by issuing the :SYSTem:ERRor:OVERload ON command. To return to the default state, issue the :SYSTem:ERRor:OVERload OFF command. In either case, Input Overloads always set the status bit.

**NOTE**

For versions of firmware before A.10.01, the Input Overload was only a Warning and so was never available in the SCPI queue, although it did set the status bit. For A.10.01 and later, the Input Overload is an error and can be enabled to the SCPI queue using this command.

Key Path	SCPI only
Remote Command	:SYSTem:ERRor:OVERload[:STATe] 0 1 OFF ON
Example	:SYST:ERR:OVER 1 Enable overload errors
Preset	Set to OFF by Restore Misc Defaults (no Overload errors go to SCPI)
State Saved	Saved in instrument state.
Initial S/W Revision	A.10.01

## System

The System screen is formatted into three groupings: product descriptive information, options tied to the hardware, and software products:

```

<Product Name> <Product Description>
Product Number: N9020A
Serial Number: US46220924
Firmware Revision: A.01.01
Computer Name: <hostname>
Host ID: N9020A,US44220924

N9020A-503      Frequency Range to 3.6 GHz
N9020A-PFR     Precision Frequency Reference
N9020A-P03     Preamp 3.6 GHz

N9060A-2FP     Spectrum Analysis Measurement Suite  1.0.0.0
N9073A-1FP     WCDMA                               1.0.0.0
N9073A-2FP     WCDMA with HSDPA                     1.0.0.0
    
```

The Previous Page is grayed-out if the first page of information is presently displayed. The Next Page menu key is grayed-out if the last page is information is presently displayed.

Key Path	System, Show
----------	--------------

Mode	All
<b>Example</b>	SYST:SHOW SYST
Backwards Compatibility Notes	The hardware statistics that are displayed in the PSA Show System screen have been moved to a dedicated Show Hardware Statistics screen in the Service Menu.
Initial S/W Revision	Prior to A.02.00

### Show System contents (Remote Command Only)

A remote command is available to obtain the contents of the Show System screen (the entire contents, not just the currently displayed page).

<b>Remote Command</b>	:SYSTem:CONFigure[:SYSTem]?
<b>Example</b>	:SYST:CONF?
Notes	The output is an IEEE Block format of the Show System contents. Each line is separated with a new-line character.
Initial S/W Revision	Prior to A.02.00

### Computer System description (Remote Command Only)

A remote command is available to obtain the Computer System description. The Computer System is the operating system and patch level as reported by operating system.

<b>Remote Command</b>	:SYSTem:CSYSem?
<b>Example</b>	:SYST:CSYS?
Notes	The return value is the Computer System name and service pack level.
Initial S/W Revision	Prior to A.12.00

## Hardware

The show hardware screen is used to view details of the installed hardware. This information can be used to determine versions of hardware assemblies and field programmable devices, in the advent of future upgrades or potential repair needs.

The screen is formatted into two groupings: product descriptive information and hardware information. The hardware information is listed in a table format:

<b>Hardware Information</b>							
MXA Signal Analyzer							
Product Number: N9020A							
Serial Number: US46220107							
Firmware Revision: A.01.14							
Assembly Name	Part #	Serial #	Mat Rev	Rev	OF Rev	Hw Id	Misc
Analog IF	E441060104	78060200131	003	0	C	15	
YIG Tuned Filter	50877305	11061500550	005	0	A	11	
Digital IF	E441060105	78060100559	003	0	F	14	
Front End Controller	E441060101	78060100147	004	2	A	8	
Low Band Switch	E441060170	78060800346	005	1	A	10	
LO Synthesizer	E441060102	78060100226	003	3	G	2	
Reference	E441060108	78060300420	004	1	C	16	
Front End	E441060154	13062800820	010	2	B	9	

The Previous Page is grayed-out if the first page of information is presently displayed. The Next Page menu is grayed-out if the last page is information is presently displayed.

---

Key Path	System, Show
Mode	All
Example	SYST:SHOW HARD
Initial S/W Revision	Prior to A.02.00

---

### LXI

This key shows you the product number, serial number, firmware revision, computer name, IP address, Host ID, LXI Class, LXI Version, MAC Address, and the Auto-MDIX Capability.

---

Key Path	System, Show
Initial S/W Revision	Prior to A.02.00

---

### System Remote Commands (Remote Commands Only)

The commands in this section have no front-panel key equivalent.

"System Powerdown (Remote Command Only)" on page 353

"List installed Options (Remote Command Only)" on page 354

"Lock the Front-panel keys (Remote Command Only)" on page 354

"List SCPI Commands (Remote Command Only)" on page 354

"SCPI Version Query (Remote Command Only)" on page 355

"Date (Remote Command Only)" on page 355

"Time (Remote Command Only)" on page 355

---

Initial S/W Revision	Prior to A.02.00
----------------------	------------------

---

### System Powerdown (Remote Command Only)

---

<b>Remote Command</b>	SYSTem:PDOWn [NORMal FORCe]
Notes	Shuts down the instrument in the normal way (NORMal) or forced way (FORCe). In case there is another application with modified data pending for saving, the application prompt the user. The system waits until the user responds in the normal mode. It will go off after 20 seconds of wait in the force mode and all data will be lost.

---

### List installed Options (Remote Command Only)

Lists the installed options that pertain to the instrument (signal analyzer). .

---

Mode	All
<b>Remote Command</b>	:SYSTem:OPTions?
<b>Example</b>	:SYST:OPT?
Notes	The return string is a comma separated list of the installed options. For example: "503,P03,PFR" :SYSTem:OPTions? and *OPT? are the same.
State Saved	No
Initial S/W Revision	Prior to A.02.00

---

### Lock the Front-panel keys (Remote Command Only)

Disables the instrument keyboard to prevent local input when the instrument is controlled remotely. Annunciation showing a "K" for 'Klock" (keyboard lock) alerts the local user that the keyboard is locked. Klock is similar to the GPIB Local Lockout function; namely that no front-panel keys are active with the exception of the Power Standby key. (The instrument is allowed to be turned-off if Klock is ON.) The Klock command is used in remote control situations where Local Lockout cannot be used.

Although primary intent of Klock is to lock-out the front panel, it will lock-out externally connected keyboards through USB. Klock has no effect on externally connected pointing devices (mice).

The front panel 'Local' key (Cancel/Esc) has no effect if Klock is ON.

Mode	All
<b>Remote Command</b>	:SYSTem:KLOCK OFF ON 0 1 :SYSTem:KLOCK?
<b>Example</b>	:SYST:KLOC ON
Notes	Keyboard lock remains in effect until turned-off or the instrument is power-cycled
Preset	Initialized to OFF at startup, unaffected by Preset
State Saved	No
Initial S/W Revision	Prior to A.02.00

### List SCPI Commands (Remote Command Only)

Outputs a list of the valid SCPI commands for the currently selected Mode.

<b>Remote Command</b>	:SYSTem:HELP:HEADers?
<b>Example</b>	:SYST:HELP:HEAD?
Notes	The output is an IEEE Block format with each command separated with the New-Line character (hex 0x0A)
Initial S/W Revision	Prior to A.02.00

### SCPI Version Query (Remote Command Only)

Returns the SCPI version number with which the instrument complies. The SCPI industry standard changes regularly. This command indicates the version used when the instrument SCPI commands were defined.

<b>Remote Command</b>	:SYSTem:VERSion?
<b>Example</b>	:SYST:VERS?
Initial S/W Revision	Prior to A.02.00

### Date (Remote Command Only)

The recommended access to the Date, Time, and Time zone of the instrument is through the Windows native control (Control Panel or accessing the Task Bar). You may also access this information remotely, as shown in this command and Time (below).

Sets or queries the date in the instrument.

Mode	All
<b>Remote Command</b>	:SYSTem:DATE "<year>,<month>,<day>" :SYSTem:DATE?



<b>Example</b>	:SYST:DATE "2006,05,26"
Notes	<p>&lt;year&gt; is the four digit representation of year. (for example, 2006)</p> <p>&lt;month&gt; is the two digit representation of year. (for example. 01 to 12)</p> <p>&lt;day&gt; is the two digit representation of day. (for example, 01 to 28, 29, 30, or 31) depending on the month and year</p> <p>Unless the current account has Power User or Administrator privileges, an error will be generated by this command and no action will be taken.</p>
Initial S/W Revision	Prior to A.02.00

### Time (Remote Command Only)

Sets or queries the time in the instrument.

Mode	All
<b>Remote Command</b>	<pre>:SYSTem:TIME "&lt;hour&gt;,&lt;minute&gt;,&lt;second&gt;"</pre> <pre>:SYSTem:TIME?</pre>
<b>Example</b>	:SYST:TIME "13,05,26"
Notes	<p>&lt;hour&gt; is the two digit representation of the hour in 24 hour format</p> <p>&lt;minute&gt; is the two digit representation of minute</p> <p>&lt;second&gt; is the two digit representation of second</p> <p>Unless the current account has Power User or Administrator privileges, an error will be generated by this command and no action will be taken.</p>
Initial S/W Revision	Prior to A.02.00

### Power On

Enables you to select how the instrument should power on. The options are: Mode and Input/Output Defaults, User Preset and Last State.

Key Path	System
Mode	All
<b>Remote Command</b>	<pre>:SYSTem:PON:TYPE MODE USER LAST</pre> <pre>:SYSTem:PON:TYPE?</pre>
<b>Example</b>	:SYST:PON:TYPE MODE
Preset	This is unaffected by a Preset but is set to Mode on a "Restore System Defaults->All"
State Saved	No
<b>Backwards Compatibility SCPI</b>	<pre>:SYSTem:PON:TYPE PRESet</pre> <p>the "PRESet" parameter is supported for backward compatibility only and behaves the same as MODE.</p>
Backwards Compatibility	The Preset Type key in legacy analyzers has been removed, and the Power On toggle key has been

Notes	replaced by this 1-of-N key in the System menu.
Initial S/W Revision	Prior to A.02.00

### Mode and Input/Output Defaults

When the analyzer is powered on in Mode and Input/Output Defaults, it performs a Restore Mode Defaults to all modes in the instrument and also performs a Restore Input/Output Defaults.

Persistent parameters (such as Amplitude Correction tables or Limit tables) are not affected at power on, even though they are normally cleared by Restore Input/Output Defaults and/or Restore Mode Defaults.

Key Path	System, Power On
Mode	All
<b>Example</b>	SYST:PON:TYPE MODE
Readback Text	Defaults
Initial S/W Revision	Prior to A.02.00

### User Preset

Sets Power On to User Preset. When the analyzer is powered on in User Preset, it will User Preset each mode and switch to the power-on mode. Power On User Preset will not affect any settings beyond what a normal User Preset affects.

**NOTE** An instrument could never power up for the first time in User Preset.

Key Path	System, Power On
Mode	All
<b>Example</b>	SYST:PON:TYPE USER
Readback Text	User Preset
Backwards Compatibility Notes	Power On User Preset will cause the instrument to power up in the power-on mode, not the last mode the instrument was in prior to shut down. Also, Power On User Preset will User Preset all modes. This does not exactly match legacy behavior.
Initial S/W Revision	Prior to A.02.00

### Last State

Sets Power On to **Last**. When the analyzer is powered on, it will put all modes in the last state they were in prior to when the analyzer was put into Power Standby and it will wake up in the mode it was last in prior to powering off the instrument. The saving of the active mode prior to shutdown happens behind the scenes when a controlled shutdown is requested by using the front panel power Standby key or by using the remote command SYSTem:PDOWn. The non-active modes are saved as they are deactivated and recalled by Power On Last State.

**NOTE**

An instrument can never power up for the first time in Last.

If line power to the analyzer is interrupted, for example by pulling the line cord plug or by switching off power to a test rack, Power On Last State may not work properly. For proper operation, Power On Last State depends on you shutting down the instrument using the Standby key or the SYSTem:PDOWn SCPI command. This will ensure the last state of each mode is saved and can be recalled during a power up.

Key Path	System, Power On
Mode	All
<b>Example</b>	SYST:PON:TYPE LAST
Notes	Power on Last State only works if you have done a controlled shutdown prior to powering on in Last. If a controlled shutdown is not done when in Power On Last State, the instrument will power up in the last active mode, but it may not power up in the active mode's last state. If an invalid mode state is detected, a Mode Preset will occur. To control the shutdown under remote control use the :SYSTem:PDOWn command.
Readback Text	Last State
Backwards Compatibility Notes	It is no longer possible to power-up the analyzer in the last mode the analyzer was running with that mode in the preset state. (ESA/PSA SYST:PRESET:TYPE MODE with SYST:PON:PRESET) You can power-on the analyzer in the last mode the instrument was running in its last state (SYST:PON:TYPE LAST), or you can specify the mode to power-up in its preset state (SYST:PON:MODE <mode>).
Initial S/W Revision	Prior to A.02.00

## Power On Application

Accesses a menu that lists the available Modes and lets you select which Mode is to be the power-on application.

This application is used for Power On Type “Mode and Input/Output Defaults” and Restore System Defaults All.

Key Path	System, Power On
Mode	All
<b>Remote Command</b>	:SYSTem:PON:MODE SA   BASIC   ADEMOD   NFIGURE   PNOISE   CDMA2K   TDSCDMA   VSA   VSA89601   WCDMA   WIMAXOFDMA :SYSTem:PON:MODE?
<b>Example</b>	SYST:PON:MODE SA
Notes	The list of possible modes (and remote parameters) to choose from is dependent on which modes are installed in the instrument.
Preset	This is unaffected by a Preset but is set on a “Restore System Defaults->All” to: For N9038A: EMI For N8973B, N8974B, N8975B, or N8976B: NFIG

---

	For all other models: SA
State Saved	No
Initial S/W Revision	Prior to A.02.00

---

## Configure Applications

The Configure Applications utility can be used to:

- select applications for preload
- determine how many applications can fit in memory at one time
- specify the order of the Modes in the Mode menu.

This utility consists of a window with instructions, a set of “Select Application” checkboxes, a “fuel bar” style memory gauge, and keys that help you set up your configuration.

For more information, see the following topics:

["Preloading Applications" on page 284](#)

["Access to Configure Applications utility" on page 285](#)

["Virtual memory usage" on page 285](#)

---

Key Path	System, Power On
<b>Example</b>	:SYST:SHOW CAPP Displays the Config Applications screen
Initial S/W Revision	A.02.00

---

## Preloading Applications

During runtime, if a Mode that is not preloaded is selected using the Mode menu or sending SCPI commands, there will be a pause while the Application is loaded. During this pause a message that says “Loading application, please wait ...” is displayed. Once loaded, the application stays loaded, so the next time you select it during a session, there is no delay.

Preloading enables you to “preload” at startup, to eliminate the runtime delay. Preloading an application will cause it to be loaded into the analyzer’s memory when the analyzer program starts up. If you do this, the delay will increase the time it takes to start up the analyzer program, but this may be preferable to having to wait the first time you select an application. Note that, once an application is loaded into memory, it cannot be unloaded without exiting and restarting the analyzer program.

Note that there are more applications available for the X-Series than can fit into Windows Virtual Memory. By allowing you to choose which licensed applications to load at startup, the Configure Applications utility allows you to make optimal use of your memory.

### Access to Configure Applications utility

A version of the utility runs the first time you power up the analyzer after purchasing it from Agilent. The utility automatically configures preloads so that as many licensed applications as possible are preloaded while keeping the total estimated virtual memory usage below the limit. This auto-configuration only takes place at the very first run, and after analyzer software upgrades.

You may, at any time, manually call up the Configure Applications utility by pressing System, Power On, Configure Applications, to find a configuration that works best for you, and then restart the analyzer program.

The utility may also be called if, during operation of the analyzer, you attempt to load more applications than can fit in memory at once.

### Virtual memory usage

There are more applications available for the X-Series than can fit into memory at any one time, so the Configure Applications utility includes a memory tracker that serves two purposes:

1. It will not let you preload more applications than will fit into memory at once.
2. You can determine how many of your favorite applications can reside in memory at one time.

The utility provides a graphical representation of the amount of memory (note that the memory in question here is Virtual memory and is a limitation imposed by the operating system, not by the amount of physical memory you have in your analyzer). You select applications to preload by checking the boxes on the left. Checked applications preload at startup. The colored fuel bar indicates the total memory required when all the checked applications are loaded (either preloaded or selected during runtime).

Here is what the fuel bar colors mean:

**RED:** the applications you have selected cannot all fit into the analyzer's memory. You must deselect applications until the fuel bar turns yellow.

**YELLOW:** the applications you have selected can all fit into the analyzer's memory, but there is less than 10% of the memory left, probably not enough to load any other applications, either via preload or by selecting a Mode while the analyzer is running..

**GREEN:** The indicator is green when <90% of the memory limit is consumed. This means the applications you have selected can all fit into the analyzer's memory with room to spare. You will likely be able to load one or more other applications without running out of memory.

### Select All

Marks all applications in the selection list. This allows you to enable all applications licensed on the instrument for pre-loading, or is a convenience for selecting all applications in one operation and then letting you deselect individual applications.

Key Path	System, Power On, Configure Applications
Initial S/W Revision	A.02.00

### Deselect All

Clears the marks from all applications in the selection list, except the Power On application. The Power On application cannot be eliminated from the pre-load list.

---

Key Path	System, Power On, Configure Applications
Initial S/W Revision	A.02.00

---

### Move Up

The application list is the order that applications appear in the Mode Menu. This key enables you to shift the selected application up in the list, thus moving the selected application earlier in the Mode Menu.

---

Key Path	System, Power On, Configure Applications
Initial S/W Revision	A.02.00

---

### Move Down

The application list is the order that applications appear in the Mode Menu. This key enables you to shift the selected application down in the list, thus moving the selected application later in the Mode Menu.

---

Key Path	System, Power On, Configure Applications
Initial S/W Revision	A.02.00

---

### Select/Deselect

Toggles the currently highlighted application in the list.

---

Key Path	System, Power On, Configure Applications
Initial S/W Revision	A.02.00

---

### Save Changes and Exit

Applies the configuration of the applications list. The marked applications will be pre-loaded in memory the next time the instrument application is started, and the order of the applications in the list will be the order of the applications in the Mode Menu.

After saving your changes, the analyzer asks you if you would like it to restart so that your changes can take effect (see dialog box, below). If you choose not to restart, the changes will not take effect until the next time you shut down and restart the analyzer.

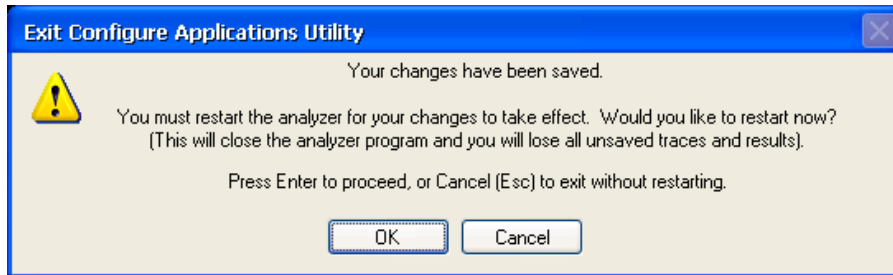

Key Path	System, Power On, Configure Applications
Remote Command	:SYSTem:PUP:PROcEss
Example	:SYST:PUP:PROC This is the SCPI command for restarting the analyzer. You must Wait after this command for the instrument application to restart
Notes	The softkey will be grayed-out when the virtual memory of the selected applications exceeds 100% of the limit.
Notes	You cannot use *WAI or *OPC? to synchronize operation after a restart. This command stops and restarts the instrument application, thus the SCPI operation is terminated and restarted. A remote program must use fixed wait time to resume sending commands to the instrument. The wait time will be dependent upon which applications are pre-loaded.
Initial S/W Revision	A.02.00
Modified at S/W Revision	A.04.00

### Exit Without Saving

Pressing this key will exit the Configure Applications utility without saving your changes.

Key Path	System, Power On, Configure Applications
Initial S/W Revision	A.02.00
Modified at S/W Revision	A.04.00

### Restore Power On Defaults

This selection causes the Power On Type and Power On Application settings to be a reset to their default values. This level of Restore System Defaults does not affect any other system settings, mode settings and does not cause a mode switch. The Power On key, under the Restore System Defaults menu, causes the same action.

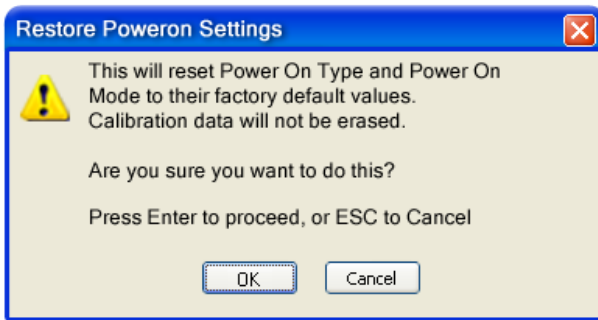

If you press any key other than OK or Enter, it is construed as a Cancel, because the only path that will actually cause the reset to be executed is through OK or Enter.

Key Path	System, Power On
Example	:SYST:DEF PON
Initial S/W Revision	Prior to A.02.00

### Configure Applications - Instrument boot-up

At start-up of the analyzer program a dialog box similar to the one under the System, Power On, Configure Applications key will be displayed allowing you to choose which licensed applications are to be loaded. This dialog will only be displayed if the memory required to pre-load all of the licensed applications exceeds the Virtual Memory available.

### Configure Applications - Windows desktop

The Configure Applications Utility may be run from the Windows Desktop. The utility is launched by double-



clicking the icon on the desktop, which brings-up a dialog box similar to the one under the System, Power On, Configure Applications key, allowing you to choose which licensed applications are to be loaded when the analyzer program starts up. This dialog box has mouse buttons on it that do the job the softkeys normally do in the System, Power On, Configure Applications menu.

### Configure Applications - Remote Commands

The following topics provide details on using remote commands to configure the list of applications you want to load into the instrument memory or query the Virtual Memory utilization for your applications.

- ["Configuration list \(Remote Command Only\)" on page 289](#)
- ["Configuration Memory Available \(Remote Command Only\)" on page 289](#)
- ["Configuration Memory Total \(Remote Command Only\)" on page 289](#)
- ["Configuration Memory Used \(Remote Command Only\)" on page 289](#)
- ["Configuration Application Memory \(Remote Command Only\)" on page 290](#)



### Configuration list (Remote Command Only)

This remote command is used to set or query the list of applications to be loaded in-memory.

<b>Remote Command</b>	:SYSTem:PON:APPLication:LLISt <string of INSTRument:SElect names> :SYSTem:PON:APPLication:LLISt?
<b>Example</b>	:SYST:PON:APPL:LLIS "SA,BASIC,WCDMA"
<b>Notes</b>	<string of INSTRument:SElect names> are from the enums of the :INSTRument:SElect command. The order of the <INSTRument:SElect names> is the order that the applications are loaded into memory, and the order that they appear in the Mode Menu. Error message -225 "Out of Memory" is reported when more applications are listed than can reside in Virtual Memory. When this occurs, the existing applications load list is unchanged.
<b>Preset</b>	Not affected by Preset
<b>State Saved</b>	Not saved in instrument state
<b>Initial S/W Revision</b>	A.02.00

### Configuration Memory Available (Remote Command Only)

This remote command is used to query the amount of Virtual Memory remaining.

<b>Remote Command</b>	:SYSTem:PON:APPLication:VMEMory[:AVAILable]?
<b>Example</b>	:SYST:PON:APPL:VMEM?
<b>Preset</b>	Not affected by Preset
<b>Initial S/W Revision</b>	A.02.00

### Configuration Memory Total (Remote Command Only)

This remote command is used to query the limit of Virtual Memory allowed for applications.

<b>Remote Command</b>	:SYSTem:PON:APPLication:VMEMory:TOTAL?
<b>Example</b>	:SYST:PON:APPL:VMEM:TOT?
<b>Preset</b>	Not affected by Preset
<b>Initial S/W Revision</b>	A.02.00

### Configuration Memory Used (Remote Command Only)

This remote command is a query of the amount of Virtual Memory used by all measurement applications.

<b>Remote Command</b>	:SYSTem:PON:APPLication:VMEMory:USED?
<b>Example</b>	:SYST:PON:APPL:VMEM:USED?
<b>Preset</b>	Not affected by Preset
<b>Initial S/W Revision</b>	A.02.00

### Configuration Application Memory (Remote Command Only)

This remote command is used to query the amount of Virtual Memory a particular application consumes.

<b>Remote Command</b>	:SYSTem:PON:APPLication:VMEMory:USED:NAME? <INSTrument:SElect name>
<b>Example</b>	:SYST:PON:APPL:VMEM:USED:NAME? CDMA2K
<b>Notes</b>	<INSTrument:SElect name> is from the enums of the :INSTrument:SElect command Value returned will be 0 (zero) if the name provided is invalid.
<b>Preset</b>	Not affected by Preset
<b>Initial S/W Revision</b>	Prior to A.02.00

### Alignments

The Alignments Menu controls and displays the automatic alignment of the instrument, and provides the ability to restore the default alignment values.

The current setting of the alignment system is displayed in the system Settings Panel along the top of the display, including a warning icon for conditions that may cause specifications to be impacted.



<b>Key Path</b>	System
<b>Initial S/W Revision</b>	Prior to A.02.00

### Auto Align

Configures the method for which the automatic background alignment is run.

Automatic background alignments are run periodically between measurement acquisitions. The instrument's software determines when alignments are to be performed to maintain warranted operation. The recommended setting for Auto Align is Normal.

An Auto Align execution cannot be aborted with the Cancel (ESC) key. To interrupt an Auto Align execution, select Auto Align Off.

<b>Key Path</b>	System, Alignments
<b>Mode</b>	All
<b>Remote Command</b>	:CALibration:AUTO ON PARTial OFF :CALibration:AUTO?
<b>Example</b>	:CAL:AUTO ON
<b>Notes</b>	While Auto Align is executing, bit 0 of Status Operation register is set.
<b>Couplings</b>	Auto Align is set to Off if Restore Align Data is invoked.

Preset	This is unaffected by Preset but is set to ON upon a “Restore System Defaults->Align”.
State Saved	No
Status Bits/OPC dependencies	When Auto Align is executing, bit 0 in the Status Operational register is set.
<b>Backwards Compatibility SCPI</b>	:CALibration:AUTO ALERt Parameter ALERt is for backward compatibility only and is mapped to PARTial
Backwards Compatibility Notes	<ol style="list-style-type: none"> <li>1. ESA SCPI for Auto Align is :CALibration:AUTO &lt;Boolean&gt;. The command for X-Series is an enumeration. Thus the parameters of “0” and “1” are not possible in X-Series.</li> <li>2. Similarly, the ESA SCPI for :CALibration:AUTO? returned the Boolean value 1 or 0, in X-Series it is an Enumeration (string). Thus, queries by customer applications into numeric variables will result in an error</li> <li>3. In PSA Auto Align OFF was not completely off, it is equivalent to PARTial in X-Series. In X-Series, OFF will be fully OFF. This means users of PSA SCPI who choose OFF may see degraded performance and should migrate their software to use PARTial.</li> </ol>
Initial S/W Revision	Prior to A.02.00

## Normal

Auto Align, Normal turns on the automatic alignment of all measurement systems. The Auto Align, Normal selection maintains the instrument in warranted operation across varying temperature and over time.

If the condition “Align Now, All required” is set, transition to Auto Align, Normal will perform the required alignments and clear the “Align Now, All required” condition and then continue with further alignments as required to maintain the instrument adequately aligned for warranted operation.

When Auto Align, Normal is selected the Auto Align Off time is set to zero.

When Auto Align, Normal is selected the Settings Panel indicates ALIGN AUTO.

Key Path	System, Alignments, Auto Align
Mode	All
<b>Example</b>	:CAL:AUTO ON
Notes	<p>Alignment processing as a result of the transition to Normal will be executed sequentially. Thus, *OPC? or *WAI following CAL:AUTO ON will return when the alignment processing is complete.</p> <p>The presence of an external signal may interfere with the RF portion of the alignment. If so, the Error Condition message “Align skipped: 50 MHz interference” or “Align skipped: 4.8 GHz interference” is reported, and bit 11 is set in the Status Questionable Calibration register. After the interfering signal is removed, subsequent alignment of the RF will clear the condition, and clear bit 11 in the Status Questionable Calibration register.</p>
Readback Text	Normal
Status Bits/OPC dependencies	An interfering user signal may prevent automatic alignment of the RF subsystem. If this occurs, the Error Condition message “Align skipped: 50 MHz interference” or “Align skipped: 4.8 GHz interference” is reported, the Status Questionable Calibration bit 11 is set, and the alignment proceeds. When a subsequent alignment of the RF subsystem succeeds, either by the next cycle of automatic alignment or from an Align Now, RF, the Error Condition and Status Questionable

	Calibration bit 11 are cleared.
Initial S/W Revision	Prior to A.02.00

### Partial

Auto Align, Partial disables the full automatic alignment and the maintenance of warranted operation for the benefit of improved measurement throughput. Accuracy is retained for the Resolution Bandwidth filters and the IF Passband, which is critical to FFT accuracy, demodulation, and many measurement applications. With Auto Align set to Partial, you are now responsible for maintaining warranted operation by updating the alignments when they expire. The Auto Align, Alert mechanism will notify you when alignments have expired. One solution to expired alignments is to perform the Align All, Now operation. Another is to return the Auto Align selection to Normal.

Auto Align, Partial is recommended for measurements where the throughput is so important that a few percent of improvement is more valued than an increase in the accuracy errors of a few tenths of a decibel. One good application of Auto Align, Partial would be an automated environment where the alignments can be called during overhead time when the device-under-test is exchanged.

When Auto Align, Partial is selected the elapsed time counter begins for Auto Align Off time.

When Auto Align, Partial is selected the Settings Panel indicates ALIGN PARTIAL with a warning icon. The warning icon is to inform the operator that they are responsible for maintaining the warranted operation of the instrument

Key Path	System, Alignments, Auto Align
Mode	All
<b>Example</b>	:CAL:AUTO PART
Notes	Auto Align Partial begins the elapsed time counter for Auto Align Off time.
Readback Text	Partial
Initial S/W Revision	Prior to A.02.00

### Off

Auto Align, Off disables automatic alignment and the maintenance of warranted operation, for the benefit of maximum measurement throughput. With Auto Align set to Off, you are now responsible for maintaining warranted operation by updating the alignments when they expire. The Auto Align, Alert mechanism will notify you when alignments have expired. One solution to expired alignments is to perform the Align All, Now operation. Another is to return the Auto Align selection to Normal.

The Auto Align, Off setting is rarely the best choice, because Partial gives almost the same improvement in throughput while maintaining the warranted performance for a much longer time. The choice is intended for unusual circumstances such as the measurement of radar pulses where you might like the revisit time to be as consistent as possible.

When Auto Align, Off is selected the Auto Align Off time is initialized and the elapsed time counter begins.

When Auto Align, Off is selected the Settings Panel indicates ALIGN OFF with a warning icon. The warning icon is to inform the operator that they are responsible for maintaining the warranted operation of the instrument:

Key Path	System, Alignments, Auto Align
Mode	All
<b>Example</b>	:CAL:AUTO OFF
Notes	Auto Align Off begins the elapsed time counter for Auto Align Off time.
Couplings	Auto Align is set to Off if Restore Align Data is invoked.
Readback Text	Off
Initial S/W Revision	Prior to A.02.00

### All but RF

Auto Align, All but RF, configures automatic alignment to include or exclude the RF subsystem. (Eliminating the automatic alignment of the RF subsystem prevents the input impedance from changing. The normal input impedance of 50 ohms can change to an open circuit when alignments are being used. Some devices under test do not behave acceptably under such circumstances, for example by showing instability.) When Auto Align, All but RF ON is selected, the operator is responsible for performing an Align Now, RF when RF-related alignments expire. The Auto Align, Alert mechanism will notify the operator to perform an Align Now, All when the combination of time and temperature variation is exceeded.

When Auto Align, All but RF ON is selected the Settings Panel indicates ALIGN AUTO/NO RF with a warning icon (warning icon is intended to inform the operator they are responsible for the maintaining the RF alignment of the instrument):

Key Path	System, Alignments, Auto Align
Mode	All
<b>Remote Command</b>	:CALibration:AUTO:MODE ALL NRF :CALibration:AUTO:MODE?
<b>Example</b>	:CAL:AUTO:MODE NRF
Preset	This is unaffected by Preset but is set to ALL on a "Restore System Defaults->Align".
State Saved	No
Readback Text	RF or NRF
Initial S/W Revision	Prior to A.02.00

### Alert

The instrument will signal an Alert when conditions exist such that you will need to perform a full alignment (for example, Align Now, All). The Alert can be configured in one of four settings; Time & Temperature, 24 hours, 7 days, or None. A confirmation is required when a selection other than Time & Temperature is chosen. This prevents accidental deactivation of alerts.

With Auto Align set to Normal, the configuration of Alert is not relevant because the instrument's software maintains the instrument in warranted operation.

Key Path	System, Alignments, Auto Align
Mode	All
Remote Command	:CALibration:AUTO:ALERt TTEMperature DAY WEEK NONE :CALibration:AUTO:ALERt?
Example	:CAL:AUTO:ALER TTEM
Notes	The alert that alignment is needed is the setting of bit 14 in the Status Questionable Calibration register.
Preset	This is unaffected by Preset but is set to TTEMperature on a "Restore System Defaults->Align".
State Saved	No
Status Bits/OPC dependencies	The alert is the Error Condition message "Align Now, All required" and bit 14 is set in the Status Questionable Calibration register.
Initial S/W Revision	Prior to A.02.00

#### Time & Temperature

With Auto Align Alert set to Time & Temperature the instrument will signal an alert when alignments expire due to the combination of the passage of time and changes in temperature. The alert is the Error Condition message "Align Now, All required". If this choice for Alert is selected, the absence of an alert means that the analyzer alignment is sufficiently up-to-date to maintain warranted accuracy.

Key Path	System, Alignments, Auto Align, Alert
Mode	All
Example	:CAL:AUTO:ALER TTEM
Readback Text	Time & Temp
Status Bits/OPC dependencies	Bit 14 is set in the Status Questionable Calibration register.
Initial S/W Revision	Prior to A.02.00

#### 24 hours

With Auto Align Alert set to 24 Hours the instrument will signal an alert after a time span of 24 hours since the last successful full alignment (for example, Align Now, All or completion of a full Auto Align). You may choose this selection in an environment where the temperature is stable on a daily basis at a small risk of accuracy errors in excess of the warranted specifications. The alert is the Error Condition message "Align Now, All required".

For front-panel operation, confirmation is required to transition into this setting of Alert. The confirmation dialog is:

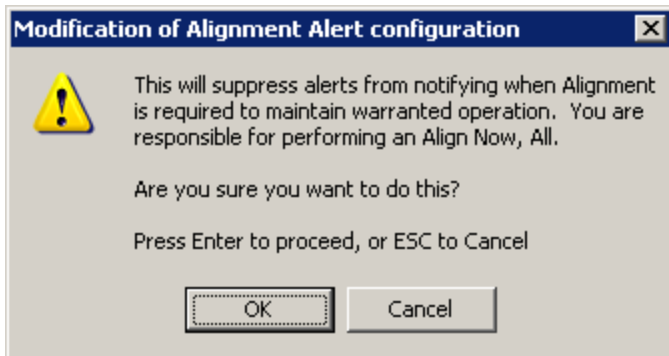

No confirmation is required when Alert is configured through a remote command.

Key Path	System, Alignments, Auto Align, Alert
Mode	All
<b>Example</b>	:CAL:AUTO:ALER DAY
Readback Text	24 hours
Status Bits/OPC dependencies	Bit 14 is set in the Status Questionable Calibration register.
Initial S/W Revision	Prior to A.02.00

### 7 days

With Auto Align Alert is set to 7 days the instrument will signal an alert after a time span of 168 hours since the last successful full alignment (for example, Align Now, All or completion of a full Auto Align). You may choose this selection in an environment where the temperature is stable on a weekly basis, at a modest risk of accuracy degradations in excess of warranted performance. The alert is the Error Condition message “Align Now, All required”.

For front panel operation, confirmation is required for the customer to transition into this setting of Alert. The confirmation dialog is:

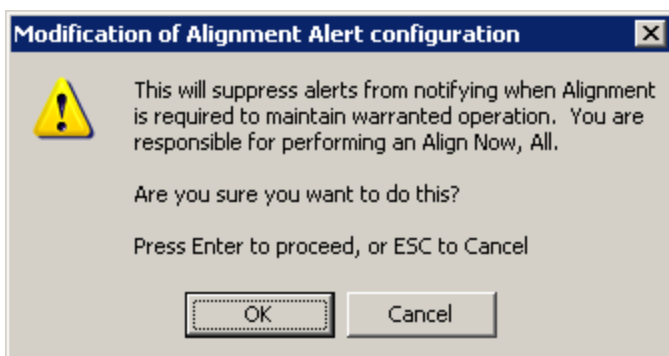

No confirmation is required when Alert is configured through a remote command.

Key Path	System, Alignments, Auto Align, Alert
Mode	All
<b>Example</b>	:CAL:AUTO:ALER WEEK
Readback Text	7 days
Status Bits/OPC dependencies	Bit 14 is set in the Status Questionable Calibration register.
Initial S/W Revision	Prior to A.02.00

**None**

With Auto Align Alert set to None the instrument will not signal an alert. This is provided for rare occasions where you are making a long measurement which cannot tolerate Auto Align interruptions, and must have the ability to capture a screen image at the end of the measurement without an alert posted to the display. Agilent does not recommends using this selection in any other circumstances, because of the risk of accuracy performance drifting well beyond expected levels without the operator being informed.

For front panel operation, confirmation is required to transition into this setting of Alert. The confirmation dialog is:

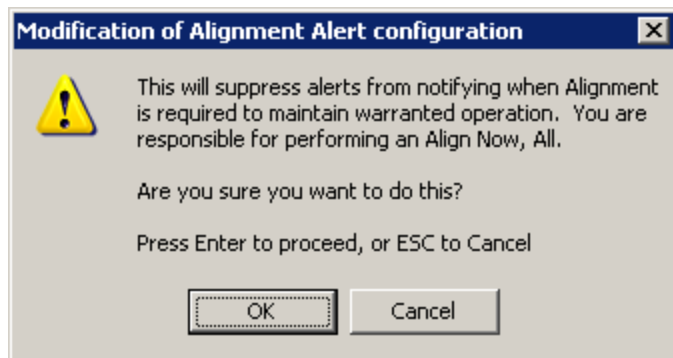

No confirmation is required when Alert is configured through a remote command.

Key Path	System, Alignments, Auto Align, Alert
Mode	All
<b>Example</b>	:CAL:AUTO:ALER NONE
Initial S/W Revision	Prior to A.02.00

**Execute Expired Alignments (Remote Command Only)**

Alignments can be expired in the situation where Auto Align is in the state of Partial or Off. This feature runs the alignments that have expired. This is different than performing an Align All, Now operation. Align All, Now performs an alignment of all subsystems regardless of whether they are needed or not, with Execute Expired Alignments, only the individual subsystems that have become due are aligned.



Mode	All
Remote Command	:CALibration:EXPIred?
Example	:CAL:EXP?
Notes	:CALibration:EXPIred? returns 0 if successful :CALibration:EXPIred? returns 1 if failed
Initial S/W Revision	Prior to A.02.00

## Align Now

Accesses alignment processes that are immediate action operations. They perform complete operations and run until they are complete.

Key Path	System, Alignments
Initial S/W Revision	Prior to A.02.00

## All

(In MXE the key label is “All (plus RF Presel 20 Hz – 3.6 GHz)”)Immediately executes an alignment of all subsystems In MXE, the Align Now All is followed by additionally aligning the RF Preselector section, so in MXE, the key label contains the parenthetical note “(plus RF Presel 20 Hz – 3.6 GHz)”. The instrument stops any measurement currently underway, performs the alignment, then restarts the measurement from the beginning (similar to pressing the Restart key).

If an interfering user signal is present at the RF Input, the alignment is performed on all subsystems except the RF. After completion, the Error Condition message “Align skipped: 50 MHz interference” or “Align skipped: 4.8 GHz interference” is generated. In addition the Error Condition message “Align Now, RF required” is generated, and bits 11 and 12 are set in the Status Questionable Calibration register.

The query form of the remote commands (:CALibration[:ALL]? or \*CAL?) invokes the alignment of all subsystems and returns a success or failure value. An interfering user signal is not grounds for failure; if the alignment was able to succeed on all portions but unable to align the RF because of an interfering signal, the resultant will be the success value.

Successful completion of Align Now, All will clear the “Align Now, All required” Error Condition, and clear bit 14 in the Status Questionable Calibration register. It will also begin the elapsed time counter for Last Align Now, All Time, and capture the Last Align Now, All Temperature.

In the MXE, successful completion will also clear the “Align 20 Hz to 30 MHz required” Error Condition, the “Align 30 MHz to 3.6 GHz required” Error Condition, and the “Align 20 Hz to 3.6 GHz required” Error Condition, and clear bits 1 and bit 2 and clear the bit 1 in the Status Questionable Calibration Extended Needed register.

If the Align RF subsystem succeeded in aligning (no interfering signal present), the elapsed time counter begins for Last Align Now, RF Time, and the temperature is captured for the Last Align Now, RF Temperature. In addition the Error Conditions “Align skipped: 50 MHz interference” and “Align skipped: 4.8

GHz interference” are cleared, the Error Condition “Align Now, RF required” is cleared, and bits 11 and 12 are cleared in the Status Questionable Calibration register

Align Now, All can be interrupted by pressing the Cancel (ESC) front-panel key or remotely with Device Clear followed by the :ABORt SCPI command. When this occurs the Error Condition message “Align Now, All required” is generated, and bit 14 is set in the Status Questionable Condition register. This is because new alignment data may be employed for an individual subsystem, but not a cohesive set of data for all subsystems.

In many cases, you might find it more convenient to change alignments to Normal, instead of executing Align Now, All. When the Auto Align process transitions to Normal, the analyzer will immediately start to update only the alignments that have expired, thus efficiently restoring the alignment process.

<b>Key Path</b>	System, Alignments, Align Now
<b>Mode</b>	All
<b>Remote Command</b>	:CALibration[:ALL] :CALibration[:ALL]?
<b>Example</b>	:CAL
<b>Notes</b>	:CALibration[:ALL]? returns 0 if successful :CALibration[:ALL]? returns 1 if failed :CALibration[:ALL]? is the same as *CAL? While Align Now, All is performing the alignment, bit 0 in the Status Operation register is set. Completion, or termination, will clear bit 0 in the Status Operation register. This command is sequential; it must complete before further SCPI commands are processed. Interrupting the alignment from remote is accomplished by invoking Device Clear followed by the :ABORt command. Successful completion will clear bit 14 in the Status Questionable Calibration register. An interfering user signal is not grounds for failure of Align Now, All. However, bits 11 and 12 are set in the Status Questionable Calibration register to indicate Align Now, RF is required. An interfering user supplied signal will result in the instrument requiring an Align Now, RF with the interfering signal removed.
<b>Couplings</b>	Initializes the time for the Last Align Now, All Time. Records the temperature for the Last Align Now, All Temperature. If Align RF component succeeded, initializes the time for the Last Align Now, RF Time. If Align RF component succeeded, records the temperature for the Last Align Now, RF Temperature.
<b>Status Bits/OPC dependencies</b>	Bits 11, 12, or 14 may be set in the Status Questionable Calibration register.
<b>Initial S/W Revision</b>	Prior to A.02.00

<b>Mode</b>	All
<b>Remote Command</b>	*CAL?
<b>Example</b>	*CAL?
<b>Notes</b>	*CAL? returns 0 if successful

	<p>*CAL? returns 1 if failed</p> <p>:CALibration[:ALL]? is the same as *CAL?</p> <p>See additional remarks described with :CALibration[:ALL]?</p> <p>Everything about :CALibration[:ALL]? is synonymous with *CAL? including all conditions, status register bits, and couplings</p>
Initial S/W Revision	Prior to A.02.00

## All but RF

(In MXE the key label is “All but RF (not including RF Presel)”)

Immediately executes an alignment of all subsystems except the RF subsystem . The instrument will stop any measurement currently underway, perform the alignment, and then restart the measurement from the beginning (similar to pressing the Restart key). This can be used to align portions of the instrument that are not impacted by an interfering user input signal.

This operation might be chosen instead of All if you do not want the device under test to experience a large change in input impedance, such as a temporary open circuit at the analyzer input.

The query form of the remote commands (:CALibration:NRF?) will invoke the alignment and return a success or failure value.

Successful completion of Align Now, All but RF will clear the “Align Now, All required” Error Condition, and clear bit 14 in the Status Questionable Calibration register. If “Align Now, All required” was in effect prior to executing the All but RF, the Error Condition message “Align Now, RF required” is generated and bit 12 in the Status Questionable Calibration register is set. It will also begin the elapsed time counter for Last Align Now, All Time, and capture the Last Align Now, All Temperature.

Align Now, All but RF can be interrupted by pressing the Cancel (ESC) front-panel key or remotely with Device Clear followed by the :ABORt SCPI command. When this occurs the Error Condition message “Align Now, All required” is generated, and bit 14 is set in the Status Questionable Condition register. This is because new alignment data may be used for an individual subsystem, but not a full new set of data for all subsystems.

In models with the RF Preselector, such as the N9038A, the “All but RF” alignment will execute an alignment of all subsystems except the RF subsystem of the Spectrum Analyzer, as well as the system gain of the RF Preselector.

Key Path	System, Alignments, Align Now
Mode	All
Remote Command	:CALibration:NRF :CALibration:NRF?
Example	:CAL:NRF
Notes	:CALibration:NRF? returns 0 if successful :CALibration:NRF? returns 1 if failed While Align Now, All but RF is performing the alignment, bit 0 in the Status Operation register is set. Completion, or termination, will clear bit 0 in the Status Operation register.

	<p>This command is sequential; it must complete before further SCPI commands are processed. Interrupting the alignment from remote is accomplished by invoking Device Clear followed by the :ABORt command.</p> <p>Successful completion will clear bit 14 in the Status Questionable Calibration register and set bit 12 if invoked with “Align Now, All required”.</p>
Couplings	<p>Initializes the time for the Last Align Now, All Time.</p> <p>Records the temperature for the Last Align Now, All Temperature.</p>
Status Bits/OPC dependencies	Bits 12 or 14 may be set in the Status Questionable Calibration register.
Initial S/W Revision	Prior to A.02.00

## RF

(In MXE the key label is “RF Only”)

Immediately executes an alignment of the RF subsystem . The instrument stops any measurement currently underway, performs the alignment, then restarts the measurement from the beginning (similar to pressing the Restart key).

This operation might be desirable if the alignments had been set to not include RF alignments, or if previous RF alignments could not complete because of interference which has since been removed.

If an interfering user signal is present at the RF Input, the alignment will terminate and generate the Error Condition message “Align skipped: 50 MHz interference” or “Align skipped: 4.8 GHz interference”, and Error Condition “Align Now, RF required”. In addition, bits 11 and 12 will be set in the Status Questionable Calibration register.

The query form of the remote commands (:CALibration:RF?) will invoke the alignment of the RF subsystem and return a success or failure value. An interfering user signal is grounds for failure.

Successful completion of Align Now, RF will begin the elapsed time counter for Last Align Now, RF Time, and capture the Last Align Now, RF Temperature.

Align Now, RF can be interrupted by pressing the Cancel (ESC) front-panel key or remotely with Device Clear followed by the :ABORt SCPI command. When this occurs, the Error Condition message “Align Now, RF required” is generated, and bit 12 is set in the Status Questionable Condition register. None of the new alignment data is used.

In models with the RF Preselector, such as the N9038A, the RF alignment will execute an alignment of the RF subsystem of the Spectrum Analyzer, as well as the RF subsystem on RF Preselector path.

Key Path	System, Alignments, Align Now
Mode	All
Remote Command	:CALibration:RF :CALibration:RF?
Example	:CAL:RF
Notes	:CALibration:RF? returns 0 if successful

	<p>:CALibration:RF? returns 1 if failed (including interfering user signal)</p> <p>While Align Now, RF is performing the alignment, bit 0 in the Status Operation register is set. Completion, or termination, will clear bit 0 in the Status Operation register.</p> <p>This command is sequential; it must complete before further SCPI commands are processed. Interrupting the alignment from remote is accomplished by invoking Device Clear followed by the :ABORt command.</p> <p>Successful completion clears the Error Conditions “Align skipped: 50 MHz interference” and “Align skipped: 4800 MHz interference” and the Error Conditions “Align RF failed” and “Align Now, RF required”, and clears bits 3, 11, and 12 in the Status Questionable Calibration register.</p> <p>A failure encountered during alignment will generate the Error Condition message “Align RF failed” and set bit 3 in the Status Questionable Calibration register.</p> <p>An interfering user signal will result in bits 11 and 12 to be set in the Status Questionable Calibration register to indicate Align Now, RF is required.</p> <p>An interfering user supplied signal will result in the instrument requiring an Align Now, RF with the interfering signal removed.</p>
Couplings	<p>Initializes the time for the Last Align Now, RF Time.</p> <p>Records the temperature for the Last Align Now, RF Temperature.</p>
Status Bits/OPC dependencies	Bits 11, 12, or 14 may be set in the Status Questionable Calibration register.
Initial S/W Revision	Prior to A.02.00

### All but RF Preselector

This function only appears in the MXE, and is identical to the Align Now All (plus RF Presel) function described above, except that the RF Preselector in the MXE is only partially aligned. Only the System Gain, Mechanical attenuator and Electronic attenuator alignments on the RF Preselector path are aligned. The purpose of these alignments is to improve the RF Preselector path amplitude variation compared to the bypass path.

Key Path	System, Alignments, Align Now
Mode	All
<b>Remote Command</b>	:CALibration:NRFPreselector :CALibration:NRFPreselector?
<b>Example</b>	:CAL:NRF
Dependencies	Only appears in MXE
Status Bits/OPC dependencies	Bits 12 or 14 may be set in the Status Questionable Calibration register.
Initial S/W Revision	A.13.00

### RF Presel Only (20 Hz to 3.6 GHz)

This key only appears in the MXE and immediately executes an alignment of the RF Preselector section. The receiver will stop any measurement currently underway, perform the alignment, and then restart the measurement from the beginning (similar to pressing the Restart key). ONLY the RF Preselector is aligned; no Align Now All function is performed first.

The query form of the remote commands (:CALibration:RFPSelector:ONLY?) will invoke the alignment of the RF Preselector on both Conducted and Radiated Band and return a success or failure value. Successful completion will clear the “Align 20 Hz to 3.6 GHz required” Error Condition, and clear bit 1 and bit 2 in the Status Questionable Calibration Extended Needed register.

The elapsed time counter will begin for Last Align Now, Conducted Time and Last Align Now Radiated Time and the temperature is captured for Last Align Now, Conducted Temperature and Last Align Now, Radiated Temperature. The alignment can be interrupted by pressing the Cancel (ESC) front-panel key or remotely with Device Clear followed by the :ABORT SCPI command. When this occurs, the Error Condition “Align 20 Hz to 3.6 GHz required” is set because new alignment data may be employed for an individual subsystem, but not a cohesive set of data for all subsystems.

The “Align 20 Hz to 3.6 GHz required” Error Condition will appear when this alignment has expired. The user is now responsible to perform the Align Now, 20 Hz to 3.6 GHz in order to keep the receiver in warranted operation. This alignment can only be performed by the user as it is not part of the Auto Align process.

<b>Key Path</b>	System, Alignments, RF Preselector, Align Now
<b>Mode</b>	All
<b>Remote Command</b>	:CALibration:RFPSelector:ONLY :CALibration:RFPSelector:ONLY?
<b>Example</b>	:CAL:RFPS:ONLY
<b>Notes</b>	:CALibration:RFPSelector:ONLY? Return 0 if successful :CALibration:RFPSelector:ONLY? Return 1 if failed When Align 20 Hz to 3.6 GHz is performing the alignment, bit 0 in the Status Operation register is set. Completion, or termination, will clear bit 0 in the Status Operation register. This command is sequential; it must complete before further SCPI commands are processed. Interrupting the alignment from remote is accomplished by invoking Device Clear followed by the :ABORT command. Successful completion will clear bit 1, bit 2 in the Status Questionable Calibration Extended Needed register and bit 0, bit 1 in Status Questionable Calibration Extended Failure register. A failure encountered during alignment will set the Error Condition “20 Hz to 3.6 GHz Alignment Failure” and set bit 1, bit 2 in the Status Questionable Calibration Extended Needed register and bit 9 in Status Questionable Calibration register. For model N9038A only.
<b>Dependencies</b>	This key does not appear in other than N9038A models, setting or querying the SCPI will generate an error. This key is grayed out if the analyzer is displaying an “Align Now All required” message. If the user presses the key while it is grayed out they will receive the informational message, “Align Now All required first.”

Couplings	<p>Initializes the time for the Last Align Conducted Now, Conducted Time.</p> <p>Initializes the time for the Last Align Radiated Now, Radiated Time.</p> <p>Records the temperature for the Last Align Conducted Now, Conducted Temperature.</p> <p>Records the temperature for the Last Align Radiated Now, Radiated Temperature.</p>
Status Bits/OPC Dependencies	<p>Bit 8 or 9 may be set in the Status Questionable Calibration register.</p> <p>Bit 1 and 2 may be set in the Status Questionable Calibration Extended Needed register.</p> <p>Bit 0 and 1 may be set in the Status Questionable Calibration Extended Failure register.</p>
Initial S/W Revision	A.13.00

## Show Alignment Statistics

Shows alignment information you can use to ensure that the instrument is operating in a specific manner. The Show Alignment Statistics screen is where you can view time and temperature information.

Values which are displayed are only updated when the Show Alignment Statistics screen is invoked, they are not updated while the Show Alignment Statistics screen is being displayed. The remote commands that access this information obtain current values.

An example of the Show Alignment Statistics screen would be similar to:

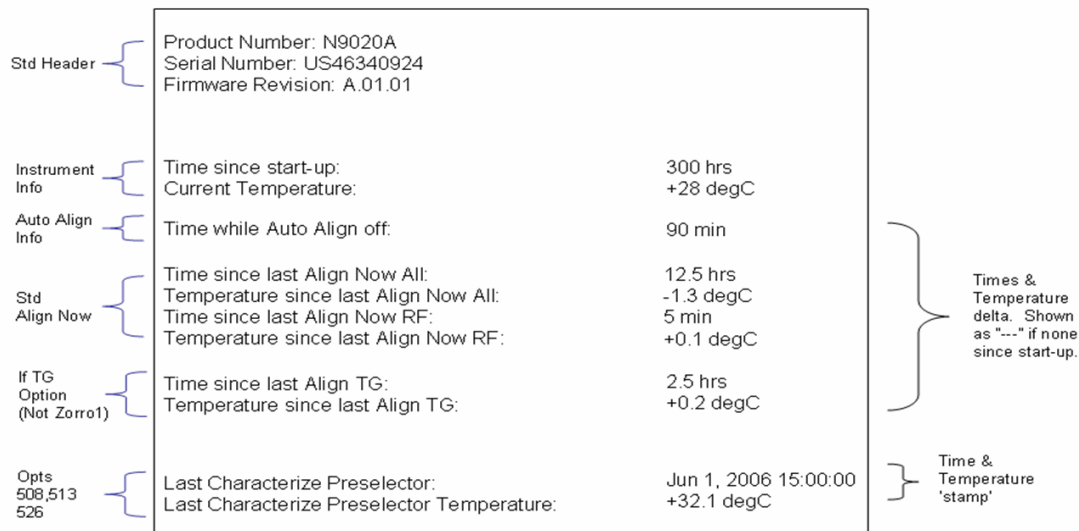

A successful Align Now, RF will set the Last Align RF temperature to the current temperature, and reset the Last Align RF time. A successful Align Now, All or Align Now, All but RF will set the Last Align Now All temperature to the current temperature, and reset the Last Align Now All time. A successful Align Now, All will also reset the Last Align RF items if the RF portion of the Align Now succeeded.

Key Path	System, Alignments
Mode	All

Notes	The values displayed on the screen are only updated upon entry to the screen and not updated while the screen is being displayed.
Initial S/W Revision	Prior to A.02.00

Key Path	Visual annotation in the Show Alignment Statistics screen
Mode	All
<b>Remote Command</b>	:SYSTem:PON:TIME?
<b>Example</b>	:SYST:PON:TIME?
Notes	Value is the time since the most recent start-up in seconds.
State Saved	No
Initial S/W Revision	Prior to A.02.00

Key Path	Visual annotation in the Show Alignment Statistics screen
Mode	All
<b>Remote Command</b>	:CALibration:TEMPerature:CURRent?
<b>Example</b>	:CAL:TEMP:CURR?
Notes	Value is in degrees Centigrade. Value is invalid if using default alignment data (Align Now, All required)
State Saved	No
Initial S/W Revision	Prior to A.02.00

Key Path	Visual annotation in the Show Alignment Statistics screen
Mode	All
<b>Remote Command</b>	:CALibration:TIME:LALL?
<b>Example</b>	:CAL:TIME:LALL?
Notes	Value is the elapsed time, in seconds, since the last successful Align Now, All or Align Now, All but RF was executed.
State Saved	No
Initial S/W Revision	Prior to A.02.00

Key Path	Visual annotation in the Show Alignment Statistics screen
Mode	All
<b>Remote Command</b>	:CALibration:TEMPerature:LALL?
<b>Example</b>	:CAL:TEMP:LALL?



Notes	Value is in degrees Centigrade at which the last successful Align Now, All or Align Now, All but RF was executed.
State Saved	No
Initial S/W Revision	Prior to A.02.00

Key Path	Visual annotation in the Show Alignment Statistics screen
Mode	All
<b>Remote Command</b>	:CALibration:TIME:LRF?
<b>Example</b>	:CAL:TIME:LRF?
Notes	Value is the elapsed time, in seconds, since the last successful Align Now, RF was executed, either individually or as a component of Align Now, All.
State Saved	No
Initial S/W Revision	Prior to A.02.00

Key Path	Visual annotation in the Show Alignment Statistics screen
Mode	All
<b>Remote Command</b>	:CALibration:TEMPerature:LRF?
<b>Example</b>	:CAL:TEMP:LRF?
Notes	Value is in degrees Centigrade at which the last successful Align Now, RF was executed, either individually or as a component of Align Now, All.
State Saved	No
Initial S/W Revision	Prior to A.02.00

Key Path	Visual annotation in the Show Alignment Statistics screen
Mode	All
<b>Remote Command</b>	:CALibration:TIME:LPreselector?
<b>Example</b>	:CAL:TIME:LPR?
Notes	Value is the date and time the last successful Characterize Preselector was executed. The date is separated from the time by a space character. Returns "" if no Characterize Preselector has ever been performed on the instrument.
Dependencies	In models that do not include preselectors, this command is not enabled and any attempt to set or query will yield an error.
State Saved	No
Initial S/W Revision	Prior to A.02.00

Key Path	Visual annotation in the Show Alignment Statistics screen
Mode	All
<b>Remote Command</b>	:CALibration:TEMPerature:LPreselector?
<b>Example</b>	:CAL:TEMP:LPR?
Notes	Value is in degrees Centigrade at which the last successful Characterize Preselector was executed.
Dependencies	In models that do not include preselectors, this command is not enabled and any attempt to set or query will yield an error.
State Saved	No
Initial S/W Revision	Prior to A.02.00

Key Path	Visual annotation in the Show Alignment Statistics screen
Mode	All
<b>Remote Command</b>	:CALibration:AUTO:TIME:OFF?
<b>Example</b>	:CAL:AUTO:TIME:OFF?
Notes	Value is the elapsed time, in seconds, since Auto Align has been set to Off or Off with Alert. The value is 0 if Auto Align is ALL or NORF.
State Saved	No
Initial S/W Revision	Prior to A.02.00

Key Path	Visual annotation in the Show Alignment Statistics screen
Mode	All
<b>Remote Command</b>	:CALibration:TIME:RFPSector:LCONducted?
<b>Example</b>	:CAL:TIME:RFPS:LCON?
Notes	Values are the date and time the last successful Align Now, 20 Hz – 30 MHz was executed. The date is separated from the time by a semi-colon character.
State Saved	No

Key Path	Visual annotation in the Show Alignment Statistics screen
Mode	All
<b>Remote Command</b>	:CALibration:TEMPerature:RFPSector:LCONducted?
<b>Example</b>	:CAL:TEMP:RFPS:LCON?
Notes	Value is in degrees Centigrade at which the last successful Align Now, 20 Hz – 30 MHz was executed.
State Saved	No

Key Path	Visual annotation in the Show Alignment Statistics screen
Mode	All
<b>Remote Command</b>	:CALibration:TIME:RFPSector:LRADiated?
<b>Example</b>	:CAL:TIME:RFPS:LRAD?
Notes	Value is the date and time the last successful Align Now, 30 MHz – 3.6 GHz was executed. The date is separated from the time by a semi-colon character.
State Saved	No

Key Path	Visual annotation in the Show Alignment Statistics screen
Mode	All
<b>Remote Command</b>	:CALibration:TEMPerature:RFPSector:LRADiated?
<b>Example</b>	:CAL:TEMP:RFPS:LRAD?
Notes	Value is in degrees Centigrade at which the last successful Align Now, 30 MHz – 3.6 GHz was executed.
State Saved	No

Key Path	Visual annotation in the Show Alignment Statistics screen
Mode	All
<b>Remote Command</b>	:CALibration:RFPSector:SCHeuler:TIME:NEXT? This query returns data using the following format “YYYY/MM/DD; HH:MM:SS”
<b>Example</b>	:CAL:RFPS:SCH:TIME:NEXT?
Notes	The next run time will be updated based on the start date/time and recurrence set by the users. “date” is representation of the date the task will run in the form of “YYYY/MM/DD” where: –YYYY is the four digit representation of year. (for example, 2009) –MM is the two digit representation of month. (for example, 01 to 12) –DD is the two digit representation of the day. (for example, 01 to 28, 29, 30 or 31 depending on the month and year) “time” is a representation of the time of day the task will run in the form of “HH:MM:SS” where: –HH is the two digit representation of the hour in 24 hour format –MM is the two digit representation of minute –SS is the two digit representation of seconds For model N9038A only.
State Saved	No

## Restore Align Defaults

Initializes the alignment user interface settings, not alignment data, to the factory default values. Align Now, All must be executed if the value of the Timebase DAC results in a change.

For front panel operation, you are prompted to confirm action before setting the alignment parameters to factory defaults:

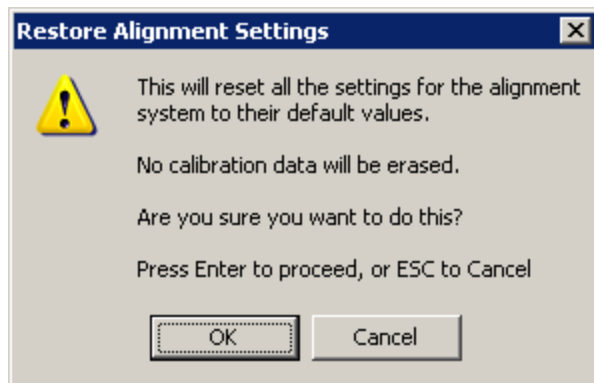

The parameters affected are:

Parameter	Setting
Timebase DAC	Calibrated
Timebase DAC setting	Calibrated value
Auto Align State	Normal (if the instrument is not operating with default alignment data, Off otherwise)
Auto Align All but RF	Off
Auto Align Alert	Time & Temperature

Key Path	System, Alignments
Mode	All
<b>Example</b>	:SYST:DEF ALIG
Notes	Alignment processing that results as the transition to Auto Alignment Normal will be executed sequentially; thus *OPC? or *WAI will wait until the alignment processing is complete.
Initial S/W Revision	Prior to A.02.00

## Backup or Restore Align Data...

Opens the utility for backing-up or restoring the alignment data.

Alignment data for the instrument resides on the hard drive in a database. Agilent uses high quality hard drives; however it is highly recommended the alignment data be backed-up to storage outside of the instrument. Additionally, for customers who use multiple CPU Assemblies or multiple disk drives, the

alignment that pertains to the instrument must be transferred to the resident hard drive after a CPU or hard drive is replaced. This utility facilitates backing-up and restoring the alignment data.

**NOTE**

This utility allows the operator to navigate to any location of the Windows file system. It is intended that the operator use a USB memory device or Mapped Network Drive to back up the alignment data to storage outside of the instrument.

Key Path	System, Alignments
Initial S/W Revision	A.02.00

Key Path	System, Alignments
Mode	All
<b>Remote Command</b>	:CALibration:DATA:Default
<b>Example</b>	:CAL:DATA:DEF
Couplings	Sets Auto Align to Off. Sets bit 14 in the Status Questionable Calibration register. The Error Condition message "Align Now, All required" is generated.
Initial S/W Revision	Prior to A.02.00

### Alignment Data Wizard

The Backup or Restore Alignment Data wizard guides you through the operation of backing-up or restoring the alignment data.

The following dialogue boxes operates without a mouse or external keyboard when you use the default file names.

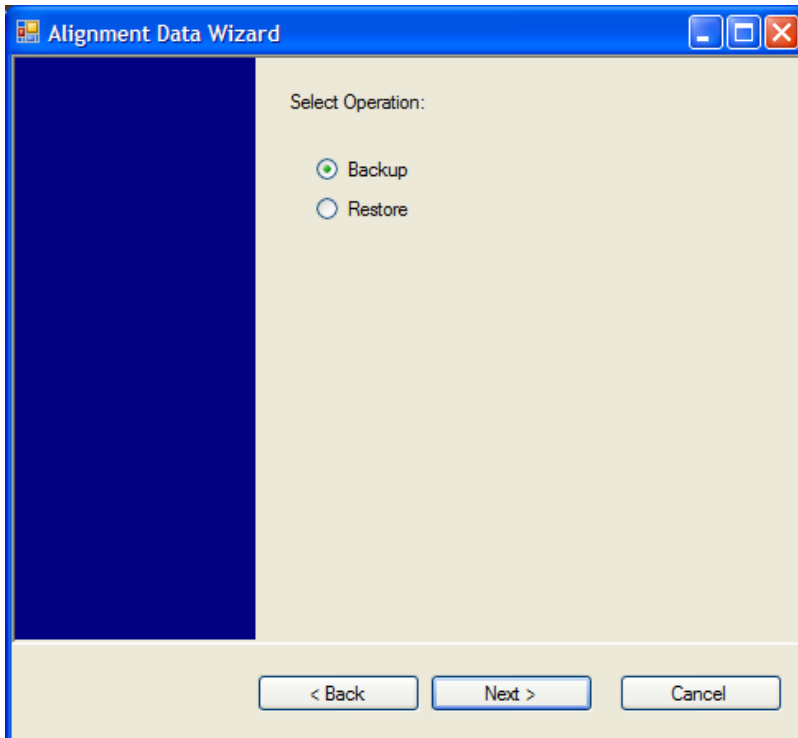
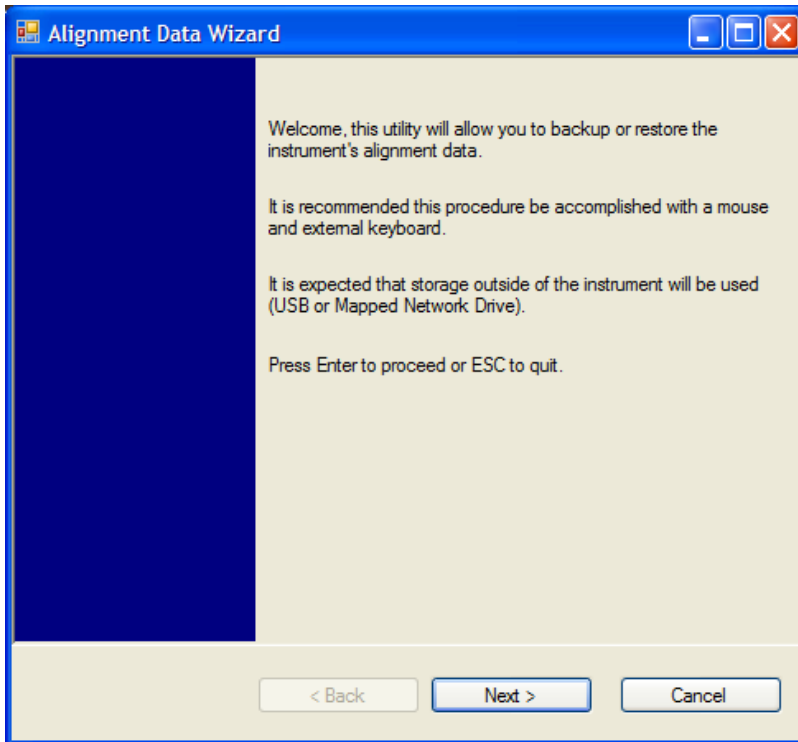

The backup screen indicates the approximate amount of space required to contain the backup file.

The default file name will be AlignDataBackup\_<model number>\_<serial number>\_<date in YYYYMMDDHHMMSS>.bak.

The default backup location will be first drive identified as an external drive (USB or LAN) if such is available; if not, the internal D: partition will be selected.

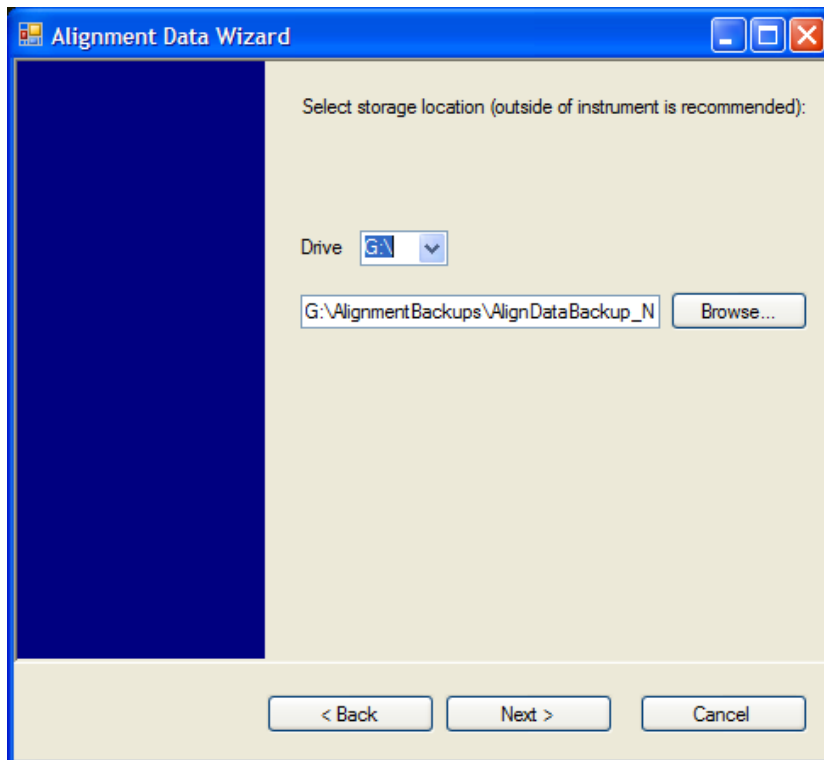

Changing the drive letter will also modify the path displayed in the box below. When this step is first loaded, the drive drop-down menu is populated with connected drives, which provide the user with write access. If there are many unreachable network drives connected to the instrument, this step can take a few seconds. If a USB drive is present, it will be selected by default. The path defaults to the AlignmentBackups folder, and a filename is automatically created in the form of AlignDataBackup\_<model>\_<serial number>\_<date><time>. When the "Next >" button is pressed, you will be prompted to create a new folder if the chosen path does not yet exist.

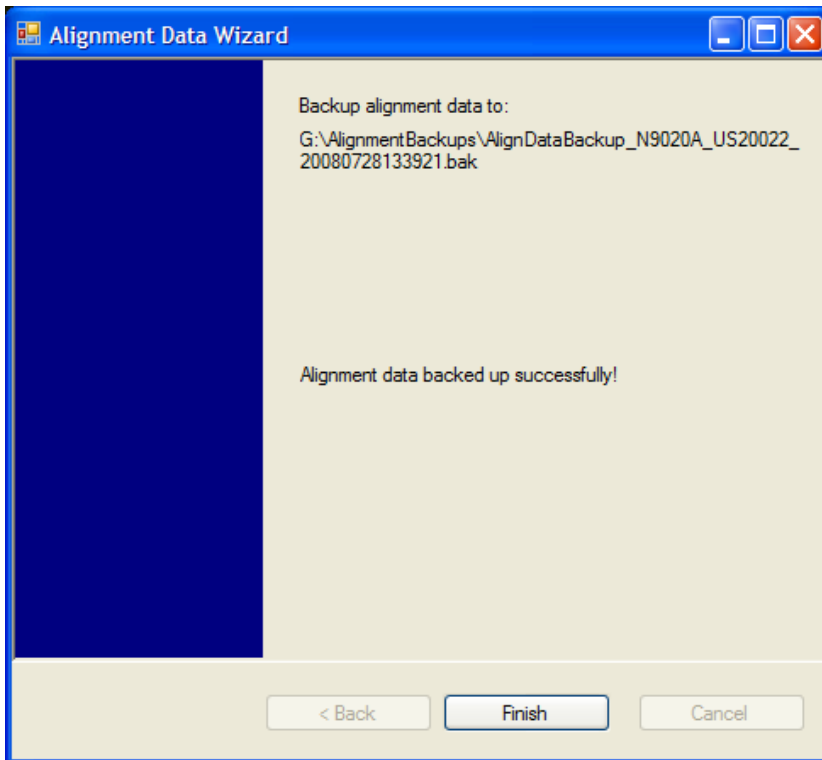
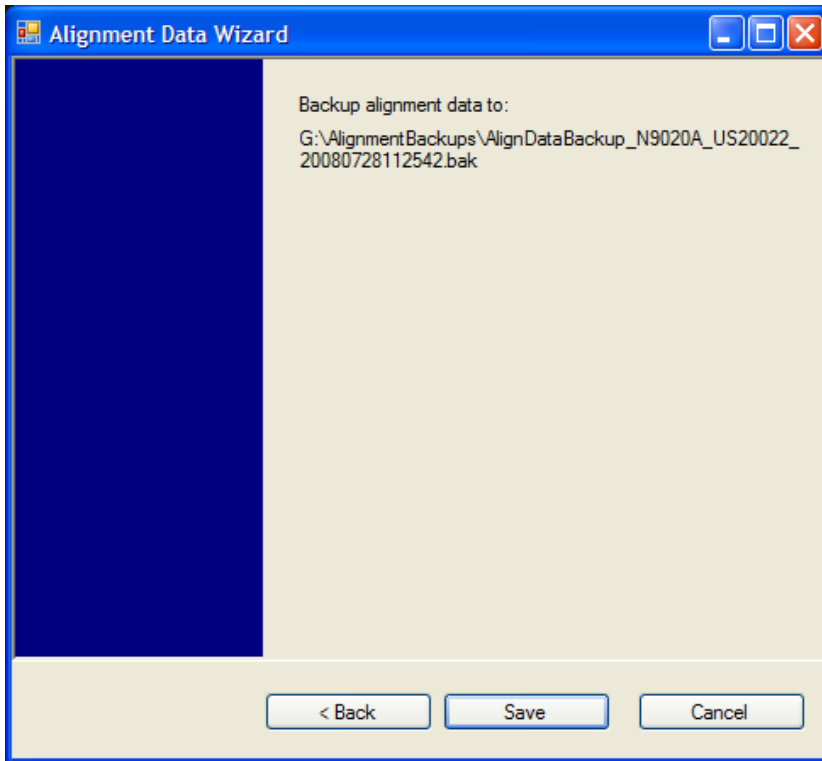

The restore operation checks the validity of the restore file using the database's built-in file validation. If the restore file is corrupt, the existing alignment data will remain in use.



If the serial number information in the backup file being restored is different from that of the instrument, the following message appears (the serial number shown are examples):

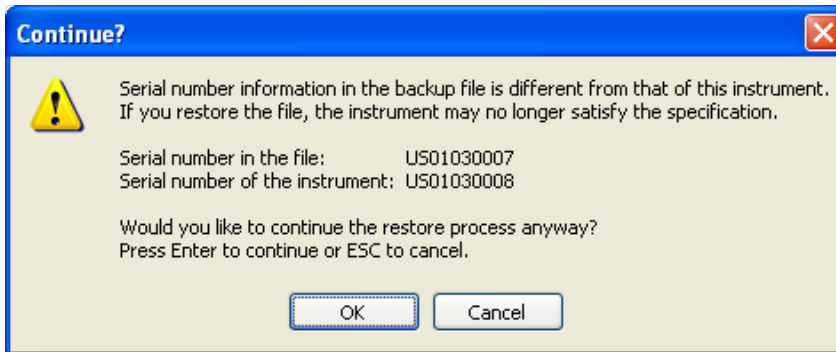

The default restore location will be first drive identified as an external drive (USB or LAN) if such is available; if not, the internal D: partition will be selected. The default restore file will be the most recent file that matches the default backup file name format: AlignDataBackup\_<model number>\_<serial number>\_<date>.bak

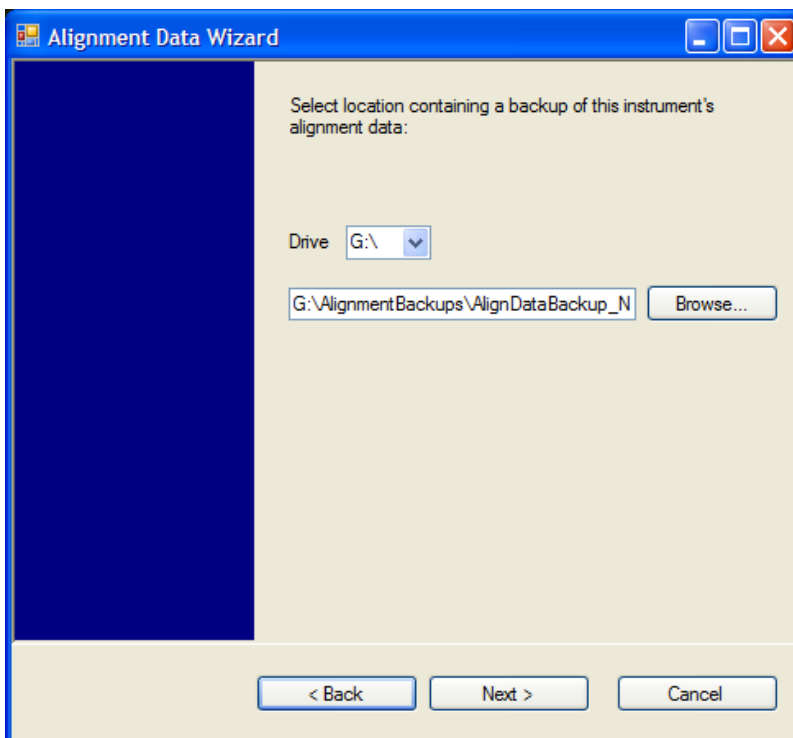

Changing the drive letter also modifies the path displayed in the box below. When this step is first loaded, the drive drop-down menu is populated with connected drives, which provide you with read access. The path defaults to the AlignBackups folder. The most recent \*.bak file in the folder will also be selected by default.

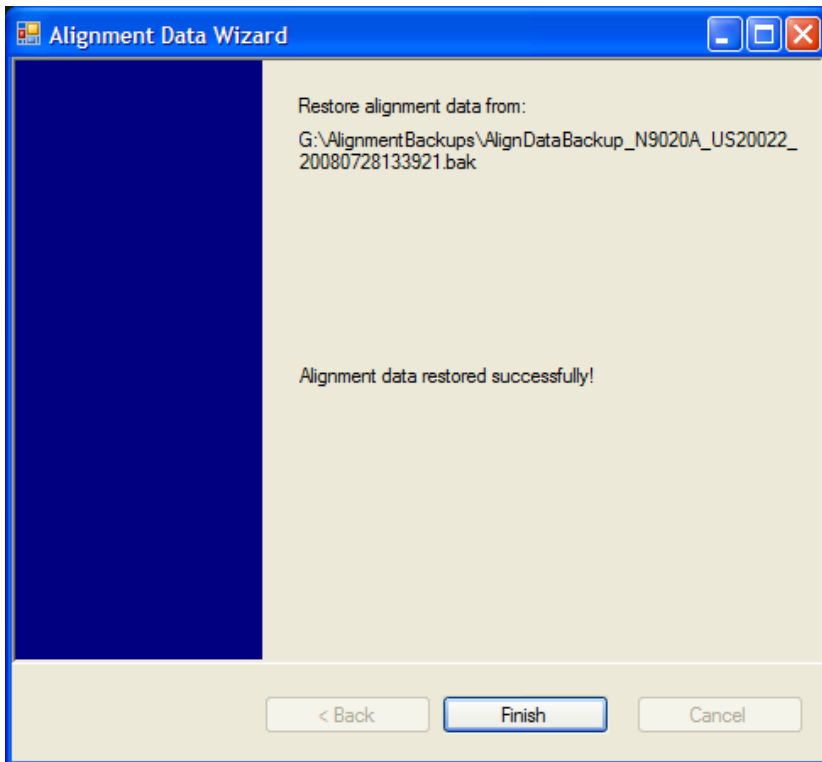
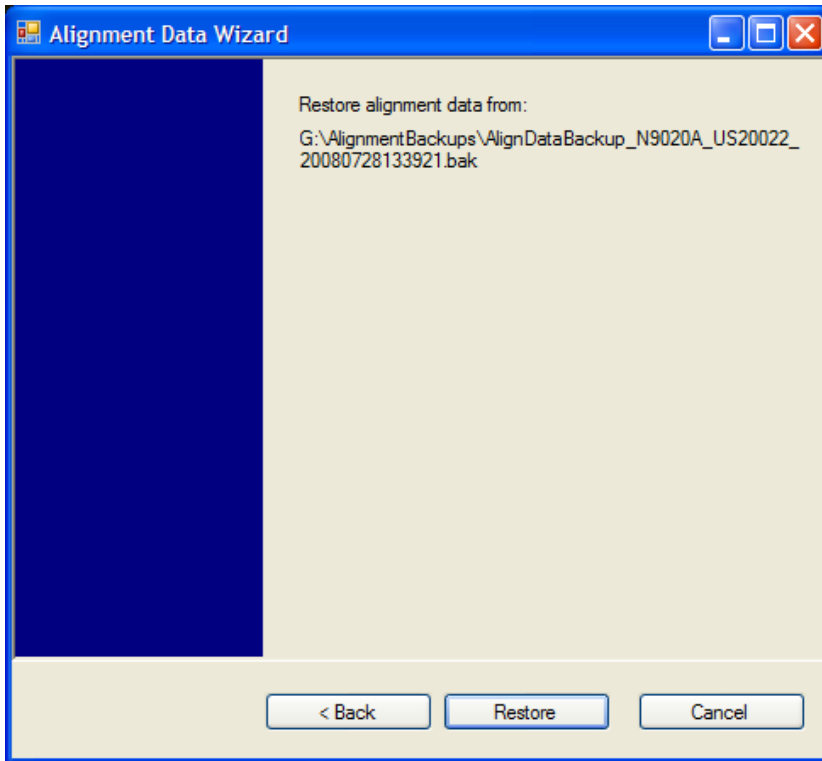

### Perform Backup (Remote Command Only)

Invokes an alignment data backup operation to the provided Folder.

**NOTE**

It is recommended that the Folder provided is outside of the instrument (USB or Mapped Network Drive).

<b>Remote Command</b>	:CALibration:DATA:BACKup <filename>
<b>Example</b>	:CAL:DATA:BACK "F:\AlignDataBackup_N9020A_US00000001_2008140100.bak"
Initial S/W Revision	A.02.00

### Perform Restore (Remote Command Only)

Invokes an alignment data restore operation from the provided filename.

<b>Remote Command</b>	:CALibration:DATA:RESTore <filename>
<b>Example</b>	:CAL:DATA:REST "F:\ AlignDataBackup_N9020A_US00000001_2008140100.bak "
Initial S/W Revision	A.02.00

### Advanced

Accesses alignment processes that are immediate action operations that perform operations that run until complete. Advanced alignments are performed on an irregular basis, or require additional operator interaction

<b>Key Path</b>	System, Alignments
Initial S/W Revision	Prior to A.02.00

### Characterize Preselector

The Preselector tuning curve drifts over temperature and time. Recognize that the Amplitude, Presel Center function adjusts the preselector for accurate amplitude measurements at an individual frequency. Characterize Preselector improves the amplitude accuracy by ensuring the Preselector is approximately centered at all frequencies without the use of the Amplitude, Presel Center function. Characterize Preselector can be useful in situations where absolute amplitude accuracy is not of utmost importance, and the throughput savings or convenience of not performing a Presel Center is desired. Presel Center is required prior to any measurement for best (and warranted) amplitude accuracy.

Agilent recommends that the Characterize Preselector operation be performed yearly as part of any calibration, but performing this operation every three months can be worthwhile.

Characterize Preselector immediately executes a characterization of the Preselector, which is a YIG-tuned filter (YTF). The instrument stops any measurement currently underway, performs the characterization, then restarts the measurement from the beginning (similar to pressing the Restart key).

The query form of the remote commands (:CALibration:YTF?) will invoke the alignment of the YTF subsystem and return a success or failure value.

A failure encountered during alignment will generate the Error Condition message "Characterize Preselector failure" and set bit 3 in the STATus:QUEStionable:CALibration:EXTended:FAILure status register. Successful completion of Characterize Preselector will clear this Condition. It will also begin the

elapsed time counter for Last Characterize Preselector Time, and capture the Last Characterize Preselector Temperature.

The last Characterize Preselector Time and Temperature survives across the power cycle as this operation is performed infrequently.

**NOTE**

The Characterize Preselector function can be interrupted by pressing the Cancel (ESC) front-panel key or remotely with Device Clear followed by the :ABORt SCPI command. None of the new characterization data is then used. However, since the old characterization data is purged at the beginning of the characterization, you now have an uncharacterized preselector. You should re-execute this function and allow it to finish before making any further preselected measurements.

Key Path	System, Alignments, Advanced
Mode	All
Remote Command	:CALibration:YTF :CALibration:YTF?
Example	:CAL:YTF
Notes	:CALibration:YTF? returns 0 if successful :CALibration:YTF? returns 1 if failed (including interfering user signal) While Advanced, Characterize Preselector is performing the alignment, bit 0 in the Status Operation register is set. Completion, or termination, will clear bit 0 in the Status Operation register. This command is sequential; it must complete before further SCPI commands are processed. Interrupting the alignment from remote is accomplished by invoking Device Clear followed by the :ABORt command. Successful completion will clear bit 9 in the Status Questionable Calibration register. A failure encountered during alignment will generate the Error Condition message "Characterize Preselector failed" and set bit 9 in the Status Questionable Calibration register. For Options that support frequencies > 3.6 GHz only.
Dependencies	This key does not appear in models that do not contain preselectors. In these models the SCPI command is accepted without error but no action is taken.
Couplings	Initializes the time for the Last Characterize Preselector Time. Records the temperature for the Last Characterize Preselector Temperature.
Initial S/W Revision	Prior to A.02.00

### Characterize Reference Clock

Characterizing the reference clock is calibrating the Reference Input Phase with the External Reference Output. This feature is only available when either option DP2 or B40 is present. It requires connecting the 10 MHz OUT to the EXT REF IN port with a BNC cable before running the characterization.

See ["Front panel guided calibration sequence" on page 318](#)

Key Path	System, Alignments, Advanced
Mode	All

<b>Remote Command</b>	:CALibration:REFErence:CLOCK?
<b>Example</b>	:CAL:REF:CLOC:INIT? //connect cable :CAL:REF:CLOC? //disconnect cable :CAL:REF:CLOC:END?
<b>Notes</b>	:CALibration:REFErence:CLOCK? returns 0 if successful :CALibration:REFErence:CLOCK? returns 1 if failed
<b>Dependencies</b>	Option DP2 or B40
<b>Couplings</b>	Initializes the time for the Last Characterize Reference Clock Time. Records the temperature for the Last Characterize Reference Clock Temperature. Expected to be run after :CAL:REF:CLOC:INIT, and before :CAL:REF:CLOC:END.
<b>Initial S/W Revision</b>	A.13.00

<b>Parameter Name</b>	Characterize Reference Clock Initialization
<b>Mode</b>	All
<b>Remote Command</b>	:CALibration:REFErence:CLOCK:INITialize?
<b>Example</b>	:CAL:REF:CLOC:INIT?
<b>Notes</b>	:CALibration:REFErence:CLOCK:INIT? returns 0 if successful :CALibration:REFErence:CLOCK:INIT? returns 1 if failed
<b>Dependencies</b>	Option DP2 or B40
<b>Couplings</b>	Expected to be run before sending the :CAL:REF:CLOC? command. This will stop the current measurement when it has completed (does not abort the current data acquisition), and it will prepare the instrument for the expected cabling.
<b>Force Restart</b>	Yes
<b>Initial S/W Revision</b>	A.12.00

<b>Parameter Name</b>	Characterize Reference Clock End
<b>Mode</b>	All
<b>Remote Command</b>	:CALibration:REFErence:CLOCK:END?
<b>Example</b>	:CAL:REF:CLOC:END?
<b>Notes</b>	:CALibration:REFErence:CLOCK:END? returns 0 if successful :CALibration:REFErence:CLOCK:END? returns 1 if failed
<b>Dependencies</b>	Option DP2 or B40
<b>Couplings</b>	Expected to be run after sending the :CAL:REF:CLOC? command, and after removing the cable used in that Characterize Reference Clock step. This will resume any queued measurements, and it concludes the reference clock characterization.
<b>Force Restart</b>	Yes
<b>Initial S/W Revision</b>	A.12.00

Parameter Name	Last Characterize Reference Clock
Key Path	Visual annotation in the Show Alignment Statistics screen
Parameter Type	String
Mode	All
Remote Command	:CALibration:TIME:REFeRence:CLOCK?
Example	:CAL:TIME:REFeRence:CLOCK?
Notes	Value is the date and time the last successful Characterize Reference Clock was executed. The date is separated from the time by a space character. Returns "" if Characterize Reference Clock has never been performed on the instrument.
Dependencies	Option DP2 or B40
State Saved	No
Initial S/W Revision	A.12.00

### Front panel guided calibration sequence

When selecting "Characterize Reference Clock" through the front panel, the following form will be shown. Step 1 of the guided calibration sequence:

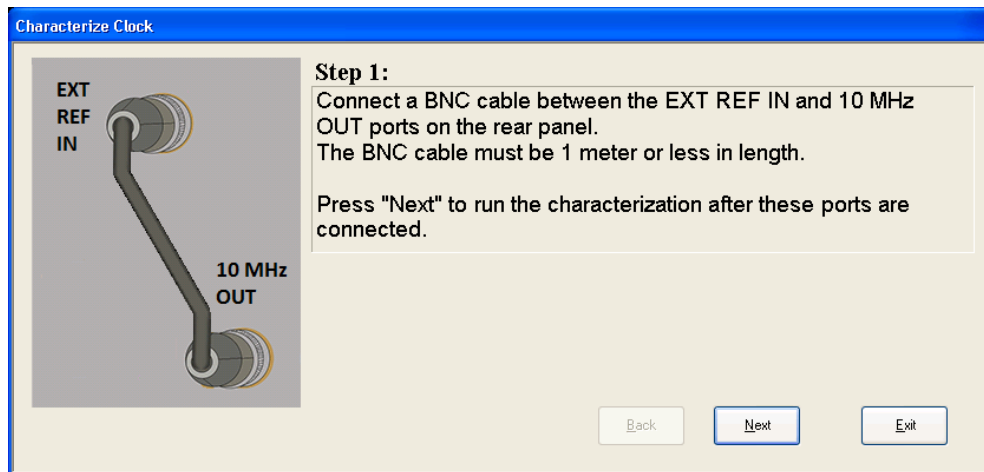

Step 2 of the guided calibration sequence:

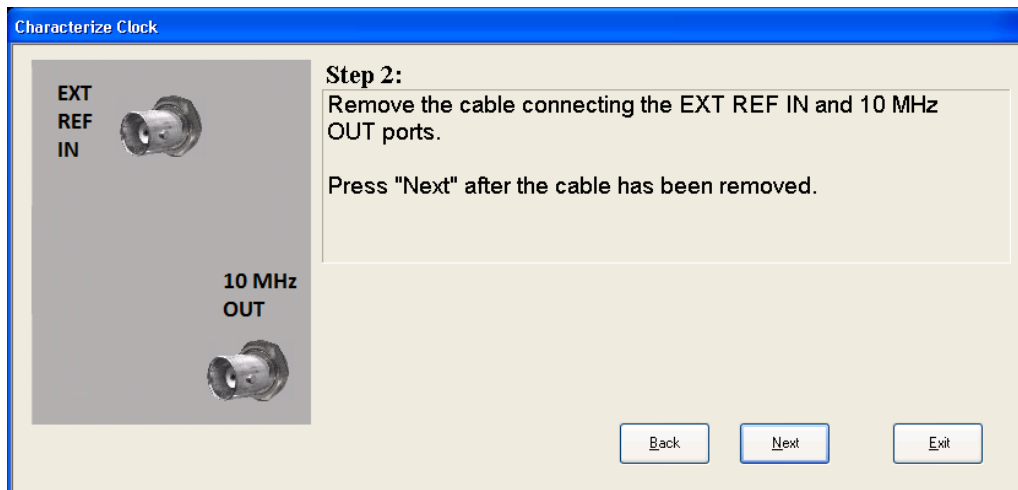

Step 3 of the guided calibration sequence:

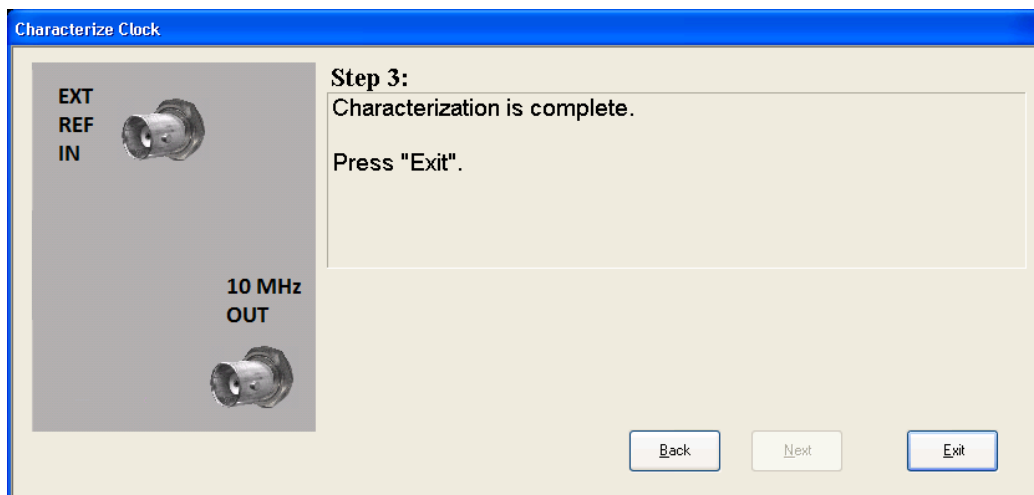

### Characterize Noise Floor

On instruments with the NF2 license installed, the calibrated Noise Floor used by Noise Floor Extensions should be refreshed periodically. To do this, press the Characterize Noise Floor key. When you press this key, the instrument stops any measurement currently underway, and a dialog appears with an OK and Cancel button which says:

"This action will take several minutes to perform. Please disconnect all cables from the RF input and press Enter to proceed. Press ESC to cancel."

When you press Enter or OK, the characterization proceeds. After the characterization, the analyzer restarts the measurement from the beginning (similar to pressing the Restart key). The characterization takes many minutes to run.

The noise floor model used by NFE includes an estimation of the temperature behavior of the noise floor, but this is only an estimation. The noise floor changes little with the age of the components. However, even small changes in the estimated level of the noise floor can make large changes in the effective noise floor, because the effective noise floor is the error in the estimation of the noise floor. Agilent recommends that

the Characterize Noise Floor operation be performed when the analyzer is operating at an ambient temperature that is significantly different than the ambient temperature at which this alignment was last run. In addition, Agilent recommends that the Characterize Noise Floor operation be performed after the first 500 hours of operation, and once every calendar year.

The noise floor model from the last operation of Characterize Noise Floor survives across the power cycle.

**NOTE**

The Characterize Noise Floor function can be interrupted by pressing the Cancel (ESC) front-panel key or remotely with Device Clear followed by the :ABORt SCPI command. None of the new characterization data is then used. However, since the old characterization data is purged at the beginning of the characterization, you now have an uncharacterized noise floor. You should re-execute this function and allow it to finish before making any further measurements with NFE. Until you do, the analyzer will display a “Characterize Noise Floor required” message and set bit 12 in the Status Questionable Calibration register (STATus:QUESTionable:CALibration:EXTended:NEEDED).

Key Path	System, Alignments, Advanced
Mode	All
Remote Command	:CALibration:NFLoor :CALibration:NFLoor?
Example	:CAL:NFL
Notes	:CALibration:NFLoor? returns 0 if successful :CALibration:NFLoor? returns 1 if failed (including interfering user signal) While Characterize Noise Floor is performing the alignment, bit ? in the Status Operation register is set. Completion, or termination, will clear bit ? in the Status Operation register. This command is sequential; it must complete before further SCPI commands are processed. Interrupting the alignment from remote is accomplished by invoking Device Clear followed by the :ABORt command. A failure encountered during characterization will generate the Error Condition message “Characterize Noise Floor failed” message and set bit ? in the Status Questionable Calibration register. Successful completion will clear bit ? in the Status Questionable Calibration register.
Dependencies	This key does not appear in models that do not contain NFE. In these models the SCPI command is accepted without error but no action is taken.
Couplings	Successful completion of Characterize Noise Floor will begin the elapsed time counter or the Last Characterize Noise Floor Time.
Initial S/W Revision	A.14.00

Key Path	Visual annotation in the Show Alignment Statistics screen
Mode	All
Remote Command	:CALibration:TIME:NFLoor?
Example	:CAL:TIME:NFL?
Notes	Value is the date and time the last successful Characterize Noise Floor was executed. The date is separated from the time by a space character. Returns “” if no Characterize Noise Floor has ever been performed on the instrument.



Dependencies	In models that do not include NFE, this command is not enabled and any attempt to set or query will yield an error.
State Saved	No
Initial S/W Revision	A.14.00

Key Path	Visual annotation in the Show Alignment Statistics screen
Mode	All
<b>Remote Command</b>	:CALibration:TEMPerature:NFLoor?
<b>Example</b>	:CAL:TEMP:NFL?
Notes	Value is the temperature of the last successful Characterize Noise Floor was executed. Returns "" if no Characterize Noise Floor has ever been performed on the instrument.
Dependencies	In models that do not include NFE, this command is not enabled and any attempt to set or query will yield an error.
State Saved	No
Initial S/W Revision	A.14.00

Key Path	Visual annotation in the Show Alignment Statistics screen
Mode	All
<b>Remote Command</b>	:CALibration:TIME:ELAPsed:NFLoor?
<b>Example</b>	:CAL:TIME:ELAP:NFL?
Notes	Value is the elapsed time the instrument was powered-on since the last successful Characterize Noise Floor was executed. Returns "" if no Characterize Noise Floor has ever been performed on the instrument.
Dependencies	In models that do not include NFE, this command is not enabled and any attempt to set or query will yield an error.
State Saved	No
Initial S/W Revision	A.14.00

## TDS Alignment

This function only appears in the MXE and this TDS alignment includes AlignNowAll and RFPreset alignment. Immediately executes an alignment of the TDS subsystem. The instrument will stop any measurement currently underway, perform the alignment, and then restart the measurement from the beginning (similar to pressing the Restart key).

Align TDS can be interrupted by pressing the Cancel (ESC) front-panel key or from remote with Device Clear followed by the :ABORT SCPI command. When this occurs, no new TDS alignment data will be employed.

<b>Key Path</b>	System, Alignments, Advanced
<b>Mode</b>	All
<b>Remote Command</b>	:CALibration:TDS
<b>Example</b>	:CAL:TDS
<b>Notes</b>	See SCPI for Align Piece
<b>Initial S/W Revision</b>	A.13.0

### Timebase DAC

Allows control of the internal 10 MHz reference oscillator timebase. This may be used to adjust for minor frequency alignment between the signal and the internal frequency reference. This adjustment has no effect if the instrument is operating with an External Frequency Reference.

If the value of the Timebase DAC changes (by switching to Calibrated from User with User set to a different value, or in User with a new value entered) an alignment may be necessary. The alignment system will take appropriate action; which will either invoke an alignment or cause an Alert.

<b>Key Path</b>	System, Alignments
<b>Mode</b>	All
<b>Remote Command</b>	:CALibration:FREQuency:REFerence:MODE CALibrated USER :CALibration:FREQuency:REFerence:MODE?
<b>Example</b>	:CAL:FREQ:REF:MODE CAL
<b>Notes</b>	If the value of the timebase is changed the alignment system automatically performs an alignment or alerts that an alignment is due. If the value of the timebase is changed the alignment system automatically performs an alignment or alerts that an alignment is due.
<b>Preset</b>	This is unaffected by Preset but is set to CALibrated on a "Restore System Defaults->Align".
<b>State Saved</b>	No
<b>Initial S/W Revision</b>	Prior to A.02.00

### Calibrated

Sets the Timebase DAC to the value established during factory or field calibration. The value displayed on the menu key is the calibrated value.

<b>Key Path</b>	System, Alignments, Timebase DAC
<b>Mode</b>	All
<b>Example</b>	:CAL:FREQ:REF:MODE CAL
<b>Readback Text</b>	[xxx] < where xxx is the calibrated value
<b>Initial S/W Revision</b>	Prior to A.02.00

## User

Allows setting the Timebase DAC to a value other than the value established during the factory or field calibration. The value displayed on the menu key is the calibrated value.

Key Path	System, Alignments, Timebase DAC
Mode	All
<b>Example</b>	:CAL:FREQ:REF:MODE USER
Readback Text	xxx < where xxx is the Timebase DAC setting
Initial S/W Revision	Prior to A.02.00

Key Path	System, Alignments, Timebase DAC
Mode	All
<b>Remote Command</b>	:CALibration:FREQuency:REFeRence:FINE <integer> :CALibration:FREQuency:REFeRence:FINE?
<b>Example</b>	:CAL:FREQ:REF:FINE 8191
Notes	If the value of the timebase is changed the alignment system automatically performs an alignment or alerts that an alignment is due.
Couplings	Setting :CAL:FREQ:REF:FINE sets :CAL:FREQ:REF:MODE USER
Preset	This is unaffected by Preset but is set to the factory setting on a "Restore System Defaults->Align".
State Saved	No
Min	0
Max	16383
<b>Backwards Compatibility SCPI</b>	:CALibration:FREQuency:REFeRence:COARse ESA hardware contained two DAC controls for the Timebase. In X-Series the command :CALibration:FREQuency:REFeRence:FINE is the method for adjusting the timebase. The :COARse command is provided as an alias to :FINE.
Initial S/W Revision	Prior to A.02.00

<b>Remote Command</b>	:CALibration:FREQuency:REFeRence:COARse <integer> :CALibration:FREQuency:REFeRence:COARse?
<b>Example</b>	:CAL:FREQ:REF:COAR 8191
Notes	This is an alias for CAL:FREQ:REF:FINE any change to COARse is reflected in FINE and vice-versa. See CAL:FREQ:REF:FINE for description of functionality.
Couplings	Setting :CAL:FREQ:REF:COAR sets :CAL:FREQ:REF:MODE USER
Initial S/W Revision	Prior to A.02.00

## RF Preselector

This menu and all of its submenus are only available in models with the RF Preselector, such as the N9038A.

See ["Align Now, 20 Hz to 30 MHz" on page 324](#)

See ["Align Now, 30 MHz to 3.6 GHz" on page 325](#)

See ["Align Now, 20 Hz to 3.6 GHz" on page 326](#)

See ["Alert" on page 327](#)

Key Path	System, Alignments
Initial S/W Revision	Prior to A.08..00

## Align Now

Accesses alignment processes that are immediate action operations. They perform complete operations and run until they are complete.

Key Path	System, Alignments, RF Preselector
Initial S/W Revision	Prior to A.08.00

### Align Now, 20 Hz to 30 MHz

Immediately executes an alignment of the receiver subsystem. The receiver will stop any measurement currently underway, perform an Align Now All, then perform the RF Preselector alignment, and then restart the measurement from the beginning (similar to pressing the Restart key).

The query form of the remote commands (:CALibration:RFPreselector:CONDUCTed?) will invoke the alignment of the RF Preselector on Conducted Band and return a success or failure value. Successful completion will clear the "Align 20 Hz to 30 MHz required" Error Condition, and clear the bit 1 in the Status Questionable Calibration Extended Needed register. The elapsed time counter will begin for Last Align Now, Conducted Time, and the temperature is captured for the Last Align Now, Conducted Temperature. The alignment can be interrupted by pressing the Cancel (ESC) front-panel key or remotely with Device Clear followed by the :ABORt SCPI command. When this occurs, the Error Condition "Align 20 Hz to 30 MHz required" is set because new alignment data may be employed for an individual subsystem, but not a cohesive set of data for all subsystems.

The "Align 20 Hz to 30 MHz required" Error Condition will appear when this alignment has expired. User is now responsible to perform the Align Now, 20 Hz to 30 MHz in order to keep the receiver in warranted operation. This alignment can only be performed by user as it is not part of the Auto Align process.

Key Path	System, Alignments, RF Preselector, Align Now
Mode	All
Remote Command	:CALibration:RFPreselector:CONDUCTed :CALibration:RFPreselector:CONDUCTed?

<b>Example</b>	:CAL:RFPS:COND
<b>Notes</b>	<p>For model N9038A only.</p> <p>:CALibration:RFPSelector:CONDUCTed? Return 0 if successful :CALibration:RFPSelector:CONDUCTed? Return 1 if failed</p> <p>When Align 20 Hz to 30 MHz is performing the alignment, bit 0 in the Status Operation register is set. Completion, or termination, will clear bit 0 in the Status Operation register.</p> <p>This command is sequential; it must complete before further SCPI commands are processed. Interrupting the alignment from remote is accomplished by invoking Device Clear followed by the :ABORt command. Successful completion will clear bit 1 in the Status Questionable Calibration Extended Needed register and bit 0 in Status Questionable Calibration Extended Failure register.</p> <p>A failure encountered during alignment will set the Error Condition “20 Hz to 30 MHz Alignment Failure” and set both bit 1 in the Status Questionable Calibration Extended Needed register and bit 9 in Status Questionable Calibration register.</p>
<b>Dependencies</b>	This key does not appear in other than N9038A models, setting or querying the SCPI will generate an error.
<b>Couplings</b>	<p>Initializes the time for the Last Align Conducted Now, Conducted Time.</p> <p>Records the temperature for the Last Align Conducted Now, Conducted Temperature.</p>
<b>Status Bits/OPC Dependencies</b>	<p>Bit 8 or 9 may be set in the Status Questionable Calibration register.</p> <p>Bit 1 may be set in the Status Questionable Calibration Extended Needed register.</p> <p>Bit 0 may be set in the Status Questionable Calibration Extended Failure register.</p>
<b>Initial S/W Revision</b>	A.08.00

### Align Now, 30 MHz to 3.6 GHz

Immediately executes an alignment of the receiver subsystem. The receiver will stop any measurement currently underway, perform an Align Now All, then perform the RF Preselector alignment, and then restart the measurement from the beginning (similar to pressing the Restart key).

The query form of the remote commands (:CALibration:RFPSelector:RADiated?) will invoke the alignment of the RF Preselector on Radiated Band and return a success or failure value. Successful completion will clear the “Align 30 MHz to 3.6 GHz required” Error Condition, and clear the bit 2 in the Status Questionable Calibration Extended Needed register. The elapsed time counter will begin for Last Align Now, Radiated Time, and the temperature is captured for the Last Align Now, Radiated Temperature. The alignment can be interrupted by pressing the Cancel (ESC) front-panel key or remotely with Device Clear followed by the :ABORt SCPI command. When this occurs, the Error Condition “Align 30 MHz to 3.6 GHz required” is set because new alignment data may be employed for an individual subsystem, but not a cohesive set of data for all subsystems.

The “Align 30 MHz to 3.6 GHz required” Error Condition will appear when this alignment has expired. User is now responsible to perform the Align Now, 30 MHz to 3.6 GHz in order to keep the receiver in warranted operation. This alignment can only be performed by user as it is not part of the Auto Align process.

<b>Key Path</b>	System, Alignments, RF Preselector, Align Now
-----------------	---

Mode	All
Remote Command	:CALibration:RFPSelector:RADiated :CALibration:RFPSelector:RADiated?
Example	:CAL:RFPS:RAD
Notes	<p>For model N9038A only.</p> <p>:CALibration:RFPSelector:RADiated? Return 0 if successful :CALibration:RFPSelector:RADiated? Return 1 if failed</p> <p>When Align 30 MHz to 3.6 GHz is performing the alignment, bit 0 in the Status Operation register is set. Completion, or termination, will clear bit 0 in the Status Operation register.</p> <p>This command is sequential; it must complete before further SCPI commands are processed. Interrupting the alignment from remote is accomplished by invoking Device Clear followed by the :ABORt command. Successful completion will clear bit 2 in the Status Questionable Calibration Extended Needed register and bit 1 in Status Questionable Calibration Extended Failure register.</p> <p>A failure encountered during alignment will set the Error Condition “30 MHz to 3.6 GHz Alignment Failure” and set both bit 2 in the Status Questionable Calibration Extended Needed register and bit 9 in Status Questionable Calibration register.</p>
Dependencies	This key does not appear in other than N9038A models, setting or querying the SCPI will generate an error.
Couplings	<p>Initializes the time for the Last Align Radiated Now, Radiated Time.</p> <p>Records the temperature for the Last Align Radiated Now, Radiated Temperature.</p>
Status Bits/OPC Dependencies	<p>Bit 8 or 9 may be set in the Status Questionable Calibration register.</p> <p>Bit 2 may be set in the Status Questionable Calibration Extended Needed register.</p> <p>Bit 1 may be set in the Status Questionable Calibration Extended Failure register.</p>
Initial S/W Revision	A.08.00

### Align Now, 20 Hz to 3.6 GHz

Immediately executes an alignment of the receiver subsystem. The receiver will stop any measurement currently underway, perform an Align Now All, then perform the RF Preselector alignment, and then restart the measurement from the beginning (similar to pressing the Restart key).

The query form of the remote commands (:CALibration:RFPSelector:FULL?) will invoke the alignment of the RF Preselector on both Conducted and Radiated Band and return a success or failure value. Successful completion will clear the “Align 20 Hz to 3.6 GHz required” Error Condition, and clear the bit 1 and bit 2 in the Status Questionable Calibration Extended Needed register. The elapsed time counter will begin for Last Align Now, Conducted Time and Last Align Now Radiated Time and the temperature is captured for Last Align Now, Conducted Temperature and Last Align Now, Radiated Temperature. The alignment can be interrupted by pressing the Cancel (ESC) front-panel key or remotely with Device Clear followed by the :ABORt SCPI command. When this occurs, the Error Condition “Align 20 Hz to 3.6 GHz required” is set because new alignment data may be employed for an individual subsystem, but not a cohesive set of data for all subsystems.

The “Align 20 Hz to 3.6 GHz required” Error Condition will appear when this alignment has expired. It is now your responsibility to perform the Align Now, 20 Hz to 3.6 GHz to keep the receiver in warranted operation. This alignment can only be performed by the user as it is not part of the Auto Align process.

Key Path	System, Alignments, RF Preselector, Align Now
Mode	All
Remote Command	:CALibration:RFPSelector:FULL :CALibration:RFPSelector:FULL?
Example	:CAL:RFPS:FULL
Notes	For model N9038A only. :CALibration:RFPSelector:FULL? Return 0 if successful :CALibration:RFPSelector:FULL? Return 1 if failed When Align 20 Hz to 3.6 GHz is performing the alignment, bit 0 in the Status Operation register is set. Completion, or termination, will clear bit 0 in the Status Operation register. This command is sequential; it must complete before further SCPI commands are processed. Interrupting the alignment from remote is accomplished by invoking Device Clear followed by the :ABORT command. Successful completion will clear bit 1, bit 2 in the Status Questionable Calibration Extended Needed register and bit 0, bit 1 in Status Questionable Calibration Extended Failure register. A failure encountered during alignment will set the Error Condition “20 Hz to 3.6 GHz Alignment Failure” and set bit1, bit 2 in the Status Questionable Calibration Extended Needed register and bit 9 in Status Questionable Calibration register.
Dependencies	This key only appears in N9038A models, setting or querying the SCPI in other models will generate an error.
Couplings	Initializes the time for the Last Align Conducted Now, Conducted Time. Initializes the time for the Last Align Radiated Now, Radiated Time. Records the temperature for the Last Align Conducted Now, Conducted Temperature. Records the temperature for the Last Align Radiated Now, Radiated Temperature.
Status Bits/OPC Dependencies	Bit 8 or 9 may be set in the Status Questionable Calibration register. Bit 1 and 2 may be set in the Status Questionable Calibration Extended Needed register. Bit 0 and 1 may be set in the Status Questionable Calibration Extended Failure register.
Initial S/W Revision	A.08.00

## Alert

Setting Alert to ON/OFF will enable/disable the display of RF Preselector alignment required message on the status line. The instrument will power up with Alert On mode.

Key Path	System, Alignments, RF Preselector
Mode	All
Remote Command	:CALibration:RFPSelector:ALERT ON OFF 0 1 :CALibration:RFPSelector:ALERT?

<b>Example</b>	:CAL:RFPS:ALER OFF
<b>Notes</b>	For model N9038A only. Error Condition will be generated when the alert is On and any of the RF Preselector alignments has expired.
<b>Preset</b>	This is unaffected by Preset, but is set to ON on a "Restore System Defaults->Align".
<b>State Saved</b>	No
<b>Initial S/W Revision</b>	A.08.00

### Schedule Setup

Enables you to schedule a task to run automatically at the background based on the recurrence and time set in the scheduler. Make sure that the Instrument's local time is accurate as the Scheduler relies on this information to execute the task.

<b>Key Path</b>	System, Alignments, RF Preselector
<b>Initial S/W Revision</b>	A.08.00

### Task

There are 3 task that can be selected for the scheduler to run.

Task 1 is the 20 Hz to 30 MHz alignment

Task 2 is the 30 MHz to 3.6 GHz alignment

Task 3 is the 20 Hz to 3.6 GHz alignment.

<b>Key Path</b>	System, Alignments, RF Preselector, Schedule Setup
<b>Mode</b>	All
<b>Remote Command</b>	:CALibration:RFPSselector:SCHeduler:TASK T1 T2 T3 :CALibration:RFPSselector:SCHeduler:TASK?
<b>Example</b>	:CAL:RFPS:SCH:TASK T1
<b>Notes</b>	Changing the task will not reset the Scheduler time and the alignment is based on the current scheduled configuration to occur. For model N9038A only.
<b>Preset</b>	This is unaffected by Preset but is set to T3 on a "Restore System Defaults->Align".
<b>State Saved</b>	No
<b>Range</b>	Task 1   Task 2   Task 3
<b>Initial S/W Revision</b>	A.08.00



### Date/Time

Enables you to configure the scheduler to run a task starting from this date and time. The date and time rely on the instrument's local time to execute a scheduled task. The date is based on the format "YYYY/MM/DD" and the time is based on a 24 hour clock.

Key Path	System, Alignments, RF Preselector, Schedule Setup
Mode	All
Remote Command	:CALibration:RFPSelector:SCHeuler:TIME:STARt "date","time" :CALibration:RFPSelector:SCHeuler:TIME:STARt? This query returns data using the following format "YYYY/MM/DD; HH:MM:SS"
Example	:CAL:RFPS:SCH:TIME:STAR "2009/8/20", "12:00:00"
Notes	"date" is representation of the date the task will run in the form of "YYYY/MM/DD" where: –YYYY is the four digit representation of year. (for example, 2009) –MM is the two digit representation of month. (for example, 01 to 12) –DD is the two digit representation of the day. (for example, 01 to 28, 29, 30 or 31 depending on the month and year) "time" is a representation of the time of day the task will run in the form of "HH:MM:SS" where: –HH is the two digit representation of the hour in 24 hour format –MM is the two digit representation of minute –SS is the two digit representation of seconds For model N9038A only.
Preset	This is unaffected by Preset but is set to Current date and 00:00:00 on a "Restore System Defaults->Align".
State Saved	No
Initial S/W Revision	A.08.00

### Date

Enables you to configure the date of the scheduled task. The SCPI command to configure the date and time parameters of the scheduler is the same; however, they each have their own front-panel control.

Key Path	System, Alignments, RF Preselector, Schedule Setup, Date/Time
Notes	See "Date/Time " on page 329. For model N9038A only.
Preset	This is unaffected by Preset but is set to Current date and 00:00:00 on a "Restore System Defaults->Align".
State Saved	No
Initial S/W Revision	A.08.00

### Time

Enables you to configure the time of the scheduled task. The SCPI command to configure the date and time parameters of the scheduler is the same; however, they each have their own front panel-control.

Key Path	System, Alignments, RF Preselector, Schedule Setup, Date/Time
Notes	See " <a href="#">Date/Time</a> " on page 329 . For model N9038A only.
Preset	This is unaffected by Preset but is set to Current date and 00:00:00 on a "Restore System Defaults->Align".
State Saved	No
Initial S/W Revision	A.08.00

### Recurrence

Enables you to configure the scheduler to run the task recurrently on a scheduled date and time. You can schedule it to run daily, weekly or alternate weeks.

Key Path	System, Alignments, RF Preselector, Schedule Setup
Mode	All
<b>Remote Command</b>	:CALibration:RFPSelector:SCHeduler:REcurrence DAY WEEK OFF :CALibration:RFPSelector:SCHeduler:REcurrence?
<b>Example</b>	:CAL:RFPS:SCH:REC DAY
Notes	For model N9038A only.
Preset	This is unaffected by Preset but is set to OFF on a "Restore System Defaults->Align".
State Saved	No
Range	DAY WEEK  OFF
Initial S/W Revision	A.08.00

### Every N Weeks

Enables you to configure the scheduler to run the task on a day in every number of week's duration.

Key Path	System, Alignments, RF Preselector, Schedule Setup, Recurrence
Initial S/W Revision	A.08.00

### N of Weeks

Enables you to set the number of weeks that the scheduler will wait to trigger a task.

Key Path	System, Alignments, RF Preselector, Schedule Setup, Recurrence, Every N Weeks
----------	---

Mode	All
<b>Remote Command</b>	:CALibration:RFPSelector:SCHeuler:RECurrence:WEEK <integer> :CALibration:RFPSelector:SCHeuler:RECurrence:WEEK?
<b>Example</b>	:CAL:RFPS:SCH:REC:WEEK 2
Notes	New scheduled date to run the alignment task will get updated when this parameter is changed. For model N9038A only.
Preset	This is unaffected by Preset but is set to 1 on a “Restore System Defaults->Align”.
State Saved	No
Range	1-52
Min	1
Max	52
Initial S/W Revision	A.08.00

### Day

Enables you to set the Day of the Week the scheduler will run a scheduled task.

Key Path	System, Alignments, RF Preselector, Schedule Setup, Recurrence, Every N Weeks
Mode	All
<b>Remote Command</b>	:CALibration:RFPSelector:SCHeuler:RECurrence:DAY SUN   MON   TUE   WED   THU   FRI   SAT :CALibration:RFPSelector:SCHeuler:RECurrence:DAY?
<b>Example</b>	:CAL:RFPS:SCH:REC:DAY SUN
Notes	For model N9038A only.
Preset	This is unaffected by Preset but is set to SUN on a “Restore System Defaults->Align”.
State Saved	No
Range	Sunday Monday Tuesday Wednesday Thursday Friday Saturday
Initial S/W Revision	A.08.00

### Scheduler

Setting the Scheduler to ON will trigger the execution of the scheduled task based on the recurrence and time set in the scheduler since the last successful of the specific alignment. A warning condition of “RF Preselector alignment scheduler is ON” will be appeared when the scheduler is set to ON. OFF will turn off the Scheduler from running any scheduled task.

Key Path	System, Alignments, RF Preselector
Mode	All
<b>Remote Command</b>	:CALibration:RFPSelector:SCHeuler:STATE ON OFF 0 1 :CALibration:RFPSelector:SCHeuler:STATE?

<b>Example</b>	:CAL:RFPS:SCH:STAT OFF
<b>Notes</b>	For model N9038A only.
<b>Preset</b>	This is unaffected by Preset but is set to OFF on a “Restore System Defaults->Align”.
<b>State Saved</b>	No
<b>Initial S/W Revision</b>	A.08.00

## I/O Config

Activates a menu for identifying and changing the I/O configuration for remote control.

<b>Key Path</b>	System
<b>Initial S/W Revision</b>	Prior to A.02.00

## GPIB

Activates a menu for configuring the GPIB I/O port.

<b>Key Path</b>	System, I/O Config
<b>Initial S/W Revision</b>	A.02.00

## GPIB Address

Select the GPIB remote address.

<b>Key Path</b>	System, I/O Config, GPIB
<b>Mode</b>	All
<b>Remote Command</b>	:SYSTem:COMMunicate:GPIB[1][:SELF]:ADDRess <integer> :SYSTem:COMMunicate:GPIB[1][:SELF]:ADDRess?
<b>Example</b>	:SYST:COMM:GPIB:ADDR 17
<b>Notes</b>	Changing the Address on the GPIB port requires all further communication to use the new address.
<b>Preset</b>	This is unaffected by Preset but is set to 18 on a “Restore System Defaults->Misc”
<b>State Saved</b>	No
<b>Range</b>	0 to 30
<b>Min</b>	0
<b>Max</b>	30
<b>Initial S/W Revision</b>	Prior to A.02.00

## GPIB Controller

Sets the GPIB port into controller or device mode. In the normal state, GPIB controller is disabled, which allows the analyzer to be controlled by a remote computer. When GPIB Controller is enabled, the instrument can run software applications that use the instrument's computer as a GPIB controller; controlling devices connected to the instrument's GPIB port.

**NOTE**

When GPIB Controller is enabled, the analyzer application itself cannot be controlled over GPIB. In this case it can easily be controlled via LAN or USB. The GPIB port cannot be a controller and device at the same time. Only one controller can be active on the GPIB bus at any given time. If the analyzer is the controller, an external PC cannot be a controller.

To control the instrument from the software that is performing GPIB controller operation, you can use an internal TCP/IP connection to the analyzer application. Use the address TCPIP0:localhost:inst0:INSTR to send SCPI commands to the analyzer application.

Key Path	System, I/O Config, GPIB
Mode	All
Scope	Mode Global
<b>Remote Command</b>	:SYSTem:COMMunicate:GPIB[1][:SELF]:CONTroller[:ENABle] ON   OFF   0   1 :SYSTem:COMMunicate:GPIB[1][:SELF]:CONTroller[:ENABle]?
<b>Example</b>	:SYST:COMM:GPIB:CONT ON Will set GPIB port to Controller
Notes	When the instrument becomes the Controller bit 0 in the Standard Event Status Register is set (and when the instrument relinquishes Controller capability bit 0 is cleared in the Standard Event Status Register).
Preset	This is unaffected by Preset but is set to OFF on a "Restore System Defaults->Misc"
State Saved	No
Range	Disabled Enabled
Initial S/W Revision	A.02.00

### Disabled

Disables the GPIB Controller capability, this is the default (or normal) setting.

Key Path	System, I/O Config, GPIB, GPIB Controller
<b>Example</b>	:SYST:COMM:GPIB:CONT OFF Will set GPIB port to Device
Initial S/W Revision	A.02.00

### Enabled

Enables the GPIB Controller capability.

Key Path	System, I/O Config, GPIB, GPIB Controller
<b>Example</b>	:SYST:COMM:GPIB:CONT ON Will set GPIB port to Controller
Initial S/W Revision	A.02.00

## SCPI LAN

Activates a menu for identifying and changing the SCPI over a LAN configuration. There are a number of different ways to send SCPI remote commands to the instrument over LAN. It can be a problem to have multiple users simultaneously accessing the instrument over the LAN. These keys limit that somewhat by disabling the telnet, socket, and/or SICL capability.

Key Path	System, I/O Config
Initial S/W Revision	Prior to A.02.00

## SCPI Telnet

Turns the SCPI LAN telnet capability On or Off allowing you to limit SCPI access over LAN through telnet.

Key Path	System, I/O Config, SCPI LAN
Mode	All
Remote Command	:SYSTem:COMMunicate:LAN:SCPI:TELNet:ENABle OFF ON 0 1 :SYSTem:COMMunicate:LAN:SCPI:TELNet:ENABle?
Example	:SYST:COMM:LAN:SCPI:TELN:ENAB OFF
Preset	This is unaffected by Preset but is set to ON with a “Restore System Defaults->Misc”
State Saved	No
Range	On   Off
Initial S/W Revision	Prior to A.02.00

## SCPI Socket

Turns the capability of establishing Socket LAN sessions On or Off. This allows you to limit SCPI access over LAN through socket sessions.

Key Path	System, I/O Config, SCPI LAN
Mode	All
Remote Command	:SYSTem:COMMunicate:LAN:SCPI:SOCKet:ENABle OFF ON 0 1 :SYSTem:COMMunicate:LAN:SCPI:SOCKet:ENABle?
Example	:SYST:COMM:LAN:SCPI:SOCK:ENAB OFF
Preset	This is unaffected by a Preset but is set to ON with a “Restore System Defaults->Misc”
State Saved	No
Range	On   Off
Initial S/W Revision	Prior to A.02.00

## SICL Server

Turns the SICL server capability On or Off, enabling you to limit SCPI access over LAN through the SICL server. (SICL IEEE 488.2 protocol.)

Parameter	Description	Setting
Maximum Connections	The maximum number of connections that can be accessed simultaneously	5
Instrument Name	The name (same as the remote SICL address) of your analyzer	inst0
Instrument Logical Unit	The unique integer assigned to your analyzer when using SICL LAN	8
Emulated GPIB Name	The name (same as the remote SICL address) of the device used when communicating with your analyzer	gpib7
Emulated GPIB Logical Unit	The unique integer assigned to your device when it is being controlled using SICL LAN	8
Emulated GPIB Address	The emulated GPIB address assigned to your transmitter tester when it is a SICL server (the same as your GPIB address)	18

Key Path	System, I/O Config, SCPI LAN
Mode	All
<b>Remote Command</b>	:SYSTem:COMMunicate:LAN:SCPI:SICL:ENABle OFF ON 0 1 :SYSTem:COMMunicate:LAN:SCPI:SICL:ENABle?
<b>Example</b>	:SYST:COMM:LAN:SCPI:SICL:ENAB OFF
Preset	This is unaffected by Preset, but is set to ON with a “Restore System Defaults->Misc”
State Saved	No
Range	On   Off
Initial S/W Revision	Prior to A.02.00

## HiSLIP Server

Turns the HiSLIP server capability On or Off, enabling you to limit SCPI access over LAN through the HiSLIP server.

HiSLIP stands for High Speed LAN Instrument Protocol and is part of the IVI-6.1 specification.

Here is an example of a VISA connection string used to connect to the HiSLIP Server on an X-Series Spectrum Analyzer:

```
TCPIP0::a-n9030a-93016::hislip0::INSTR
```

In the example above, hislip0 is the HiSLIP device name that VISA users must include in their HiSLIP VISA Address strings. Your HiSLIP device name may be different depending on your VISA settings.

Key Path	System, I/O Config, SCPI LAN
----------	------------------------------

Mode	All
<b>Remote Command</b>	:SYSTem:COMMunicate:LAN:SCPI:HISLip:ENABle OFF ON 0 1 :SYSTem:COMMunicate:LAN:SCPI:HISLip:ENABle?
<b>Example</b>	:SYST:COMM:LAN:SCPI:HISL:ENAB OFF
Preset	This is unaffected by Preset, but is set to ON with a “Restore System Defaults->Misc”
State Saved	No
Range	On   Off
Initial S/W Revision	A.11.00

### SCPI Socket Control Port (Remote Command Only)

Returns the TCP/IP port number of the control socket associated with the SCPI socket session. This query enables you to obtain the unique port number to open when a device clear is to be sent to the instrument. Every time a connection is made to the SCPI socket, the instrument creates a peer control socket. The port number for this socket is random. The user must use this command to obtain the port number of the control socket. To force a device clear on this socket, open the port and send the string “DCL” to the instrument.

If this SCPI command is sent to a non SCPI Socket interface, then 0 is returned.

Mode	All
<b>Remote Command</b>	:SYSTem:COMMunicate:LAN:SCPI:SOCKet:CONTrol?
<b>Example</b>	:SYST:COMM:LAN:SCPI:SOCK:CONT?
Preset	This is unaffected by Preset or “Restore System Defaults->Misc”.
State Saved	No
Range	0 to 65534
Min	0
Max	65534
Initial S/W Revision	Prior to A.02.00

### Reset Web Password

The embedded web server contains certain capability which are password protected; modifying the LAN configuration of the instrument, and access to web pages that can change the settings of the instrument. The default password from the factory is ‘agilent’ (without the quotes). The control provided here is the means to set the web password as the user desires, or to reset the password to the factory default.

Selecting Reset web password brings up a control for resetting the password as the user desires, or to the factory default. A keyboard is required to change the password from the factory default of ‘agilent’ or to set a new password that contains alphabetic characters. The control is:



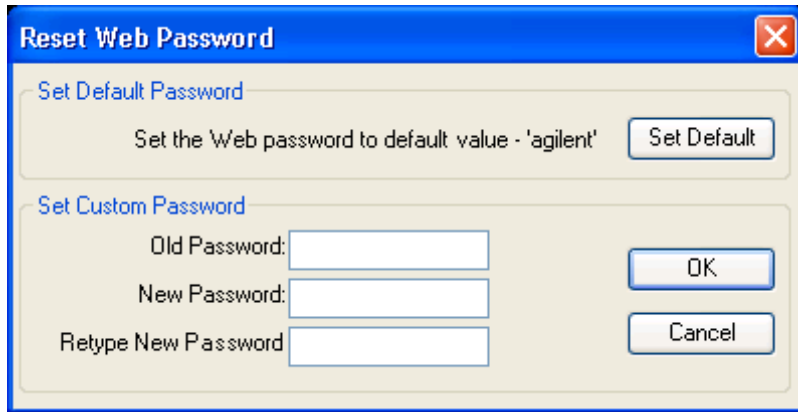

If this control is entered without an external keyboard or mouse connected, you can cancel the control by pressing the Cancel (ESC) front-panel key.

Key Path	System, I/O Config
Mode	All
Initial S/W Revision	Prior to A.02.00

## LXI

Opens a menu that allows you to access the various LXI configuration properties.

Key Path	System, I/O Config
Initial S/W Revision	Prior to A.02.00

## LAN Reset

Resets the LAN connection.

Key Path	System, I/O Config, LXI
Initial S/W Revision	Prior to A.02.00

## Device Identification (Remote Command Only)

Enabling the LXI device identification will place the LXI Status Indicator to the 'Identify' state. Disabling the LXI device identification will place the LXI Status Indicator to the 'No Fault' state. The LXI Status indicator is in the upper left region of the instrument's graphical user interface (.

Mode	All
<b>Remote Command</b>	:LXI:IDENtify[:STATe] OFF ON 0 1 :LXI:IDENtify[:STATe]?

<b>Example</b>	:LXI:IDEN ON
Preset	Not part of Preset, but reset to OFF on Restore System Defaults All
State Saved	No
Range	On   Off
Initial S/W Revision	A.12.50

## System IDN Response

This key allows you to specify a response to the \*IDN? query, or to return the analyzer to the Factory response if you have changed it.

To choose the factory-set response, press the Factory key.

To specify your own response, press the User key, and enter your desired response.

Key Path	System, I/O Config
Mode	All
<b>Remote Command</b>	:SYSTem:IDN <string> :SYSTem:IDN?
Notes	<ul style="list-style-type: none"> <li>• This affects the response given in all Modes of the Analyzer, unless the current Mode has also specified a custom response, in which case the current Mode's custom IDN response takes precedence over the System's, but only while that Mode is the current Mode..</li> <li>• It survives shutdown and restart of the software and therefore survives a power cycle</li> <li>• Null string as parameter restores the Factory setting</li> </ul>
Preset	This is unaffected by Preset but is set to the original factory setting on a "Restore System Defaults->Misc"
State Saved	No
Initial S/W Revision	A.06.00

## Factory

This key selects the factory setting, for example:

"Agilent Technologies,N9020A,MY00012345,A.05.01"

where the fields are manufacturer, model number, serial number, firmware revision.

Key Path	System, I/O Config, IDN Response
<b>Example</b>	:SYST:IDN "" null string, restores the factory setting
Initial S/W Revision	A.06.0

## User

This key allows you to specify your own response to the \*IDN? query. You may enter your desired response with the Alpha Editor or a plugin PC keyboard.

When you press this key, the active function becomes the current User string with the cursor at the end. This makes it easy to edit the existing string.

If you enter a null string (for example, by clearing the User String while editing and then pressing Done) the analyzer automatically reverts to the Factory setting.

<b>Key Path</b>	System, I/O Config, IDN Response
<b>Example</b>	:SYST:IDN "XYZ Corp, Model 12, 012345, A.01.01" user specified response
<b>Initial S/W Revision</b>	A.06.00

## Query USB Connection (Remote Command Only)

Enables you to determine the speed of the USB connection.

<b>Mode</b>	All
<b>Remote Command</b>	:SYSTem:COMMunicate:USB:CONNecTion?
<b>Example</b>	:SYST:COMM:USB:CONN?
<b>Notes</b>	NONE – Indicates no USB connection has been made. LSPeed – Indicates a USB low speed connection (1.5 Mbps).  This is reserved for future use, the T+M488 protocol is not supported on low speed connections. HSPeed – Indicates that a USB high speed connection (480 Mbps) has been negotiated. FSPeed – Indicates that a USB full speed connection (12 Mbps) has been negotiated.
<b>State Saved</b>	No
<b>Range</b>	NONE LSPeed HSPeed FSPeed
<b>Initial S/W Revision</b>	Prior to A.02.00

## USB Connection Status (Remote Command Only)

Enables you to determine the current status of the USB connection.

<b>Mode</b>	All
<b>Remote Command</b>	:SYSTem:COMMunicate:USB:STATus?
<b>Example</b>	:SYST:COMM:USB:STAT?
<b>Notes</b>	SUSPended – Indicates that the USB bus is currently in its suspended state. The bus is in the suspended state when: <ul style="list-style-type: none"> <li>• The bus is not connected to any controller</li> </ul>

	<ul style="list-style-type: none"> <li>• The controller is currently powered off</li> <li>• The controller has explicitly placed the USB device into the suspended state.</li> </ul> <p>When in the suspended state, no USB activity, including start of frame packets are received.</p> <p>ACTive – Indicates that the USB device is in the active state. When the device is in the active state, it is receiving periodic start of frames but it isn't necessarily receiving or transmitting data.</p>
State Saved	No
Range	SUSPended ACTive
Initial S/W Revision	Prior to A.02.00

### USB Packet Count (Remote Command Only)

Enables you to determine the number of packets received and transmitted on the USB bus.

Mode	All
<b>Remote Command</b>	:SYSTem:COMMunicate:USB:PACKets?
<b>Example</b>	:SYST:COMM:USB:PACK?
Notes	<p>Two integers are returned. The first is the number of packets received since application invocation, the second is the number of packets transmitted since application invocation. If no packets have been received or transmitted the response is 0,0.</p> <p>The packet count is initialized to 0,0 when the instrument application is started.</p>
State Saved	No
Initial S/W Revision	Prior to A.02.00

### Restore Defaults

Provides incremental initialization of the system setting groups along with supporting a comprehensive reset of the entire instrument back to a factory default state. The menu selections are the groups of system settings and when one is selected, that particular group of system settings is reset back to their default values.

Key Path	System
Mode	All
<b>Remote Command</b>	:SYSTem:DEFault [ALL]   ALIGn   INPut   MISC   MODes   PON
<b>Example</b>	SYST:DEF
State Saved	No
Initial S/W Revision	Prior to A.02.00

## Restore Input/Output Defaults

Causes the group of settings and data associated with Input/Output front-panel key to be a reset to their default values. This level of Restore System Defaults does not affect any other system settings, mode settings and does not cause a mode switch. .

Confirmation is required to restore the Input/Output setting. The confirmation dialog is:

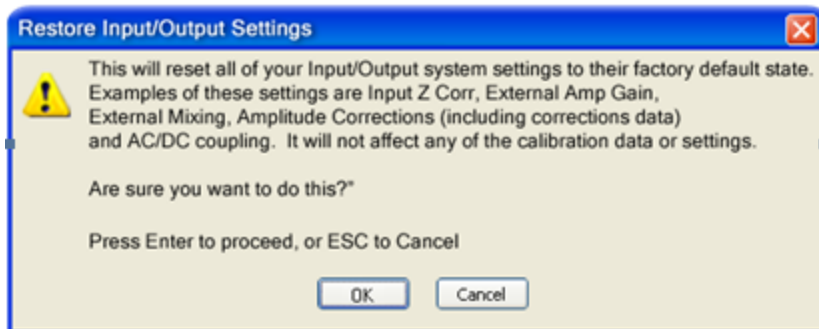

Key Path	System, Restore System Defaults
<b>Example</b>	:SYST:DEF INP
Initial S/W Revision	Prior to A.02.00

## Restore Power On Defaults

This selection causes the Power On settings to be a reset to their default value. This level of Restore System Defaults does not affect any other system settings, mode settings and does not cause a mode switch. The Power On settings and their default values are Power On Type reset to Mode and Input/Output Defaults and Power On Application reset to whatever the factory set as its default value.

Confirmation is required to restore the factory default values. The confirmation dialog is:

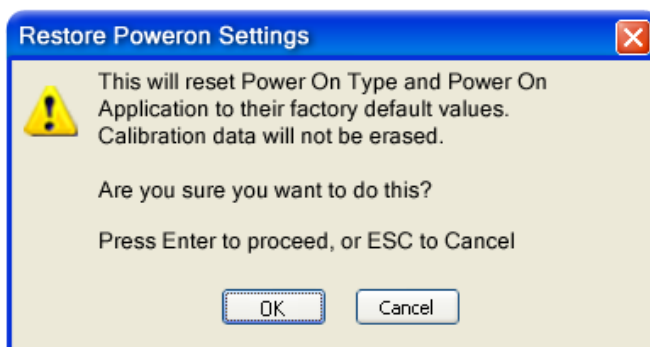

Key Path	System, Restore System Defaults
<b>Example</b>	:SYST:DEF PON
Initial S/W Revision	Prior to A.02.00

## Restore Align Defaults

This selection causes the Alignment system settings to be a reset to their default values. This does not affect any Alignment data stored in the system. This level of Restore System Defaults does not affect any other system settings, mode settings and does not cause a mode switch.

After performing this function, it may impact the auto-alignment time of the instrument until a new alignment baseline has been established.

Confirmation is required to restore the factory default values. The confirmation dialog is:

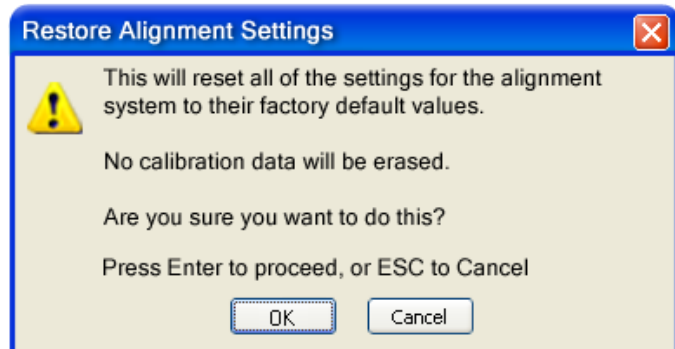

---

Key Path                      System, Restore System Defaults

---

**Example**                      :SYST:DEF ALIG

---

Initial S/W Revision        Prior to A.02.00

---

## Restore Misc Defaults

This selection causes miscellaneous system settings to be reset to their default values. With this reset, you lose the GPIB address and it is reset to 18, so this should be used with caution. This level of Restore System Defaults does not affect any other system settings, mode settings and does not cause a mode switch. This miscellaneous group contains the rest of the settings that have not been part of the other Restore System Defaults groups. The following table is a complete list of settings associated with this group:

Miscellaneous Setting	Default Value
Verbose SCPI	Off
The SYST:PRES:TYPE	MODE
Auto File Name Number	000
Save Type	State
State Save To	Register 1
Screen Save To	SCREEN000.png
DISP:ENABle	ON
Full Screen	Off

Miscellaneous Setting	Default Value
SCPI Telnet	ON
SCPI Socket	ON
SICL Server	ON
Softkey Language	English
System Annotation	ON
Display Theme	TDColor
System IDN Response	Factory result of *IDN?
Display Intensity	100
Display Backlight	ON
GPIB Address	18

Confirmation is required to restore the factory default values. The confirmation dialog is:

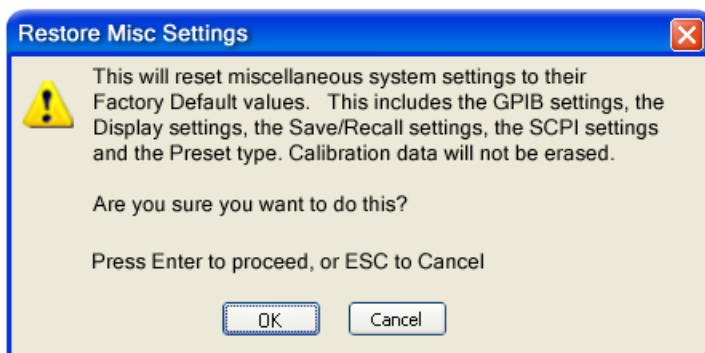

Key Path	System, Restore System Defaults
<b>Example</b>	:SYST:DEF MISC
Initial S/W Revision	Prior to A.02.00

### Restore Mode Defaults (All Modes)

This selection resets all of the modes in the instrument back to their default state just as a Restore Mode Defaults does and it switches the instrument to the power-on mode and causes the default measurement for the power-on mode to be active. This level of Restore System Defaults does not affect any system settings, but it does affect the state of all modes and does cause a mode switch unless the instrument was already in the power-on mode.

Confirmation is required to restore the factory default values. The confirmation dialog is:

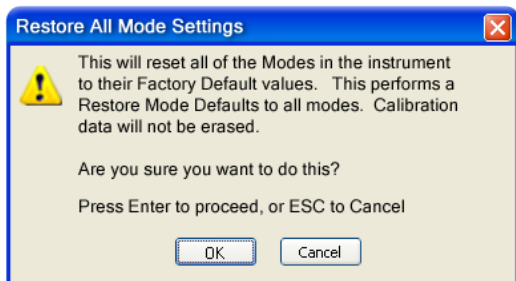

Key Path	System, Restore System Defaults
Example	:SYST:DEF MOD
Couplings	An All Mode will cause the currently running measurement to be aborted, mode switch to the power-on mode and activate the default measurement for the power-on mode.. It gets the mode to a consistent state with all of the default couplings set.
Initial S/W Revision	Prior to A.02.00

## All

This performs a comprehensive reset of ALL analyzer settings to their factory default values. It resets all of the system setting groups, causes a Restore Mode Defaults for all modes in the instrument, and switches back to the power-on mode. It does not affect the User Preset file or any user saved files.

Confirmation is required to restore the factory default values. The confirmation dialog is:

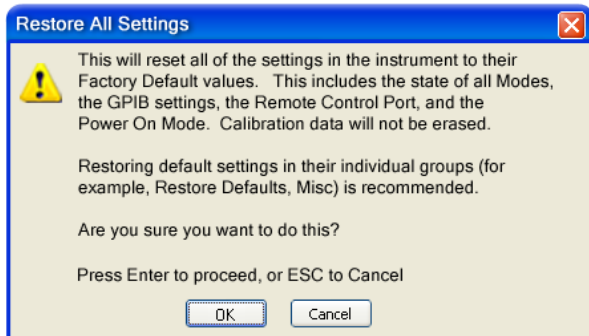

### NOTE

If you are using an Agilent USB External Mixer, then you will need to perform a Refresh USB Mixer Connection after Restoring All Defaults.

Key Path	System, Restore System Defaults
Example	:SYST:DEF ALL
Notes	If using Agilent USB External Mixer, perform a Refresh USB Mixer Connection (SCPI command :MIX:BAND USB) following a Restore All Defaults.
Couplings	An All will cause the currently running measurement to be aborted and get all modes to a consistent state, so it is unnecessary to couple any settings.
Initial S/W Revision	Prior to A.02.00
Modified at S/W Revision	A.14.00



## Control Panel...

Opens the Windows Control Panel. The Control Panel is used to configure certain elements of Windows that are not configured through the hardkey/softkey System menus.

**NOTE** This feature is not available if option SF1 is installed.

The Control Panel is a separate Windows application, so to return to the analyzer once you are in the Control Panel, you may either:

Exit the Control Panel by clicking on the red X in the upper right hand corner, with a mouse

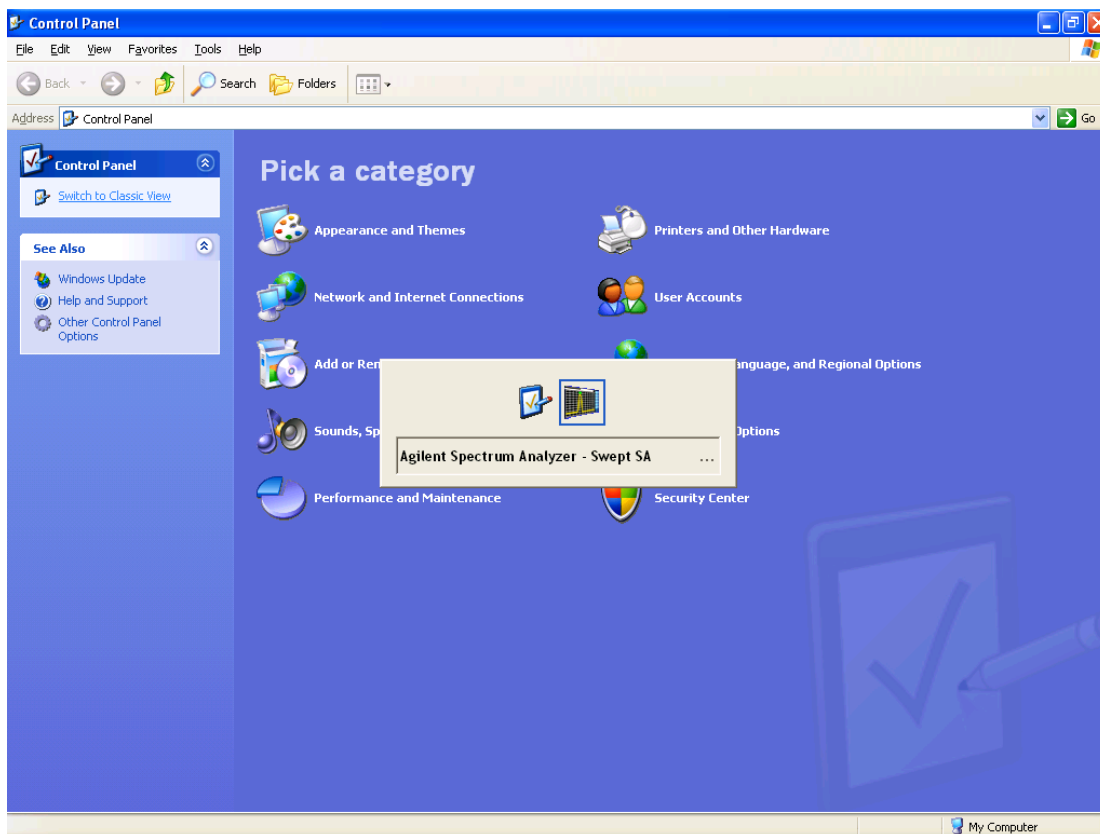

Or use Alt-Tab: press and hold the Alt key and press and release the Tab key until the Analyzer logo is showing in the window in the center of the screen, as above, then release the Alt key.

Key Path	System
Notes	No remote command for this key.
Initial S/W Revision	Prior to A.02.00

## Licensing...

Opens the license explorer.

**NOTE** This feature is not available if option SF1 is installed.

For Help on this key, select Help in the menu bar at the top of the license explorer window.

Key Path	System
Notes	No equivalent remote command for this key.
Backwards Compatibility Notes	In ESA the SCPI command for displaying the Show Licenses screen is: :SYSTem:CONFigure:LKEY:STATe OFF ON 0 1:SYSTem:CONFigure:LKEY:STATe? There are no equivalent SCPI commands in the X-Series for displaying the License Explorer.
Initial S/W Revision	Prior to A.02.00

<b>Remote Command</b>	:SYSTem:LKEY <"OptionInfo">, <"LicenseInfo">
<b>Example</b>	SYST:LKEY "N9073A-1FP", "027253AD27F83CDA5673A9BA5F427FDA5E4F25AEB1017638211AC9F60D9C639FE539735909C551DE0A91"
Notes	The <"OptionInfo"> contains the feature and the version. You must specify the feature but can omit the version. If you omit the version, the system regards it as the latest one, since the system knows which version is supported for each feature.  The <"LicenseInfo"> contains the signature, the expiration date, and serial number for transport if transportable. You must specify the signature, but you can omit the other information. If you omit the expiration date, the system regards it as permanent. If you omit the serial number, the system regards it as non-transportable. As a result, this supports reverse compatibility.
Initial S/W Revision	Prior to A.02.00

<b>Remote Command</b>	:SYSTem:LKEY:DElete <"OptionInfo">,<"LicenseInfo">
<b>Example</b>	SYST:LKEY:DEL 'N9073A-1FP', "027253AD27F83CDA5673A9BA5F427FDA5E4F25AEB1017638211AC9F60D9C639FE539735909C551DE0A91"
Notes	The <"OptionInfo"> contains the feature and the version. You must specify the feature but can omit the version. If you omit the version, the system regards it as the latest one, if more than one version is installed.  The <"LicenseInfo"> contains the signature, the expiration date, and whether or not be transportable. You must specify the signature, but you can omit the other information. If you omit the expiration date, the system regards it as permanent. If you omit the transportability, the system regards it as non-transportable. As a result, this supports reverse compatibility.
Initial S/W Revision	Prior to A.02.00

<b>Remote Command</b>	:SYSTem:LKEY:LIST?
Notes	<p>Return Value:</p> <p>An &lt;arbitrary block data&gt; of all the installed instrument licenses.</p> <p>The format of each license is as follows.</p> <p>&lt;Feature&gt;,&lt;Version&gt;,&lt;Signature&gt;,&lt;Expiration Date&gt;,&lt;Serial Number for Transport&gt;</p> <p>Return Value Example:</p> <p>#3136</p> <p>N9073A-1FP,1.000,B043920A51CA</p> <p>N9060A-2FP,1.000,4D1D1164BE64</p> <p>N9020A-508,1.000,389BC042F920</p> <p>N9073A-1F1,1.000,5D71E9BA814C,13-aug-2005</p> <p>&lt;arbitrary block data&gt; is:</p> <p>#NMMM&lt;data&gt;</p> <p>Where:</p> <p>N is the number of digits that describes the number of MMM characters. For example if the data was 55 bytes, N would be 2.</p> <p>MMM would be the ASCII representation of the number of bytes. In the previous example, N would be 55.</p> <p>&lt;data&gt; ASCII contents of the data</p>
Initial S/W Revision	Prior to A.02.00
<b>Remote Command</b>	:SYSTem:LKEY? <"OptionInfo">
<b>Example</b>	SYST:LKEY? "N9073A-1FP"
Notes	<p>The &lt;"OptionInfo"&gt; contains the feature and the version. You must specify the feature but can omit the version. If you omit the version, the system regards it as the latest one.</p> <p>Return Value:</p> <p>&lt;"LicenseInfo"&gt; if the license is valid, null otherwise.</p> <p>&lt;"LicenseInfo"&gt; contains the signature, the expiration date, and serial number if transportable.</p> <p>Return Value Example:</p> <p>"B043920A51CA"</p>
Initial S/W Revision	Prior to A.02.00
<b>Remote Command</b>	:SYSTem:HID?
Notes	Return value is the host ID as a string
Initial S/W Revision	Prior to A.02.00

## Security

Accesses capabilities for operating the instrument in a security controlled environment.

Key Path	System
Initial S/W Revision	A.04.00

## USB

The Windows operating system can be configured to disable write access to the USB ports for users who are in a secure environment where transferring data from the instrument is prohibited. This user interface is a convenient way for the customer to disable write access to USB.

Key Path	System, Security
Mode	All
Scope	Mode Global
<b>Remote Command</b>	:SYSTem:SECurity:USB:WPRotect[:ENABLE] ON OFF 0 1 :SYSTem:SECurity:USB:WPRotect[:ENABLE]?
<b>Example</b>	:SYST:SEC:USB:WPR ON Will set USB ports to Read-only
Notes	When the USB ports are in Read-only mode then no data can be stored to USB, including the internal USB memory used for a back-up location for the calibration data.
Dependencies	This key is grayed-out unless the current user has administrator privileges.
Preset	This is unaffected by Preset or any Restore System Defaults. An Agilent Recovery will set the USB to write protect OFF
State Saved	No
Range	Read-Write Read only
Initial S/W Revision	A.04.00

## Read-Write

Selection for allowing full read-write access to the USB ports.

Key Path	System, Security, USB
<b>Example</b>	:SYST:SEC:USB:WPR OFF Will set USB ports to Read-Write
Initial S/W Revision	A.04.00

## Read only

Selection for disabling write access to the USB ports.

---

Key Path	System, Security, USB	
<b>Example</b>	:SYST:SEC:USB:WPR ON	Will set USB ports to Read only
Initial S/W Revision	A.04.00	

---

## Diagnostics

The Diagnostics key in the System menu gives you access to basic diagnostic capabilities of the instrument.

---

Key Path	System
Initial S/W Revision	Prior to A.02.00

---

## Show Hardware Statistics

Provides a display of various hardware statistics. The statistics include the following:

- Mechanical relay cycles
- High and Low temperature extremes
- Elapsed time that the instrument has been powered-on (odometer)

The display should appear listing the statistics, product number, serial number, and firmware revision.

Hardware Statistical Information	
Agilent MXA Signal Analyzer	
Product Number: N9020A	
Serial Number: US00061145	
Instrument SW Revision: A.12.00	
Revision Date: 7/11/2012 12:11:10 PM	
Component Name	Value
MechAtten #1 Count Total	457304
Calibrator Switch Cycles	105953
AC/DC Switch Cycles	114240
2 dB #1 Mechanical Atten Cycles	112655
2 dB #2 Mechanical Atten Cycles	124456
MechAtten #2 Count Total	472265
6 dB Mechanical Atten Cycles	115302
10 dB Mechanical Atten Cycles	93602
20 dB Mechanical Atten Cycles	144781
30 dB Mechanical Atten Cycles	118580
Low Noise Path Switch	45668
Preselector Bypass Cycles	31133
High temperature operating extreme	45.75
Low temperature operating extreme	-23.9375
Elapsed Time (On-Time)(hours)	134164

In some CXA models this field is called "Fixed Atten"

Some CXA models omit these fields

Only shown if LNP installed

Only shown if MPB installed

The CXA models in which the AC/DC Switch field is called Fixed Atten and that omit the mechanical attenuation fields are the N9000A-503/507 models.

Modular HWs only have time and temperature information in Show Hardware Statistics.

The data will be updated only when the Show Hardware Statistics menu key is pressed, it will not be updated while the screen is displayed.

The tabular data should be directly printable.

Key Path	System, Diagnostics
Mode	All
Notes	The values displayed on the screen are only updated upon entry to the screen and not updated while the screen is being displayed.
Initial S/W Revision	Prior to A.02.00

### SCPI for Show Hardware Statistics ( Remote Commands Only)

Each of the hardware statistic items can be queried via SCPI.

- "Query the Mechanical Relay Cycle Count" on page 351
- "Query the Operating Temperature Extremes" on page 351
- "Query the Elapsed Time since 1st power on" on page 351

### Query the Mechanical Relay Cycle Count

Return the count of mechanical relay cycles. For N9038A model, there are additional 2 Mechanical Relays which are <N9038A Input2>, <N9038A Bypass>.

<b>Remote Command</b>	:SYSTem:MRELay:COUNT?
<b>Example</b>	:SYST:MREL:COUN?
<b>Notes</b>	<p>Query Only</p> <p>The return value is a comma separated list of the individual counts for each mechanical relay.</p> <p>The position of the relays in the list is:          “&lt;Cal Signal&gt;,&lt;AC/DC&gt;,&lt;2dB #1 Atten&gt;,&lt;2dB #2 Atten&gt;,&lt;6dB Atten&gt;,&lt;10dB Atten&gt;,&lt;20dB Atten&gt;,&lt;30dB Atten&gt;,&lt;Fixed Atten&gt;,&lt;Low Noise Path Switch&gt;,&lt;Presel Bypass&gt;,&lt;N9038A Input2&gt;,&lt;N9038A Bypass&gt;”</p> <p>Items in the list not pertaining to your particular hardware configuration will return as -999 for those items.</p>
Initial S/W Revision	Prior to A.02.00
Modified at S/W Revision	A.08.00

### Query the Operating Temperature Extremes

Returns the low operating temperature extreme value. The value survives a power-cycle and is the temperature extreme encountered since the value was reset by the factory or service center.

<b>Mode</b>	All
<b>Remote Command</b>	:SYSTem:TEMPerature:LEXTreme?
<b>Example</b>	:SYST:TEMP:LEXT?
<b>Notes</b>	Value is in degrees Celsius at which the lowest operating temperature has been recorded since 1st power-up.
State Saved	No
Initial S/W Revision	Prior to A.02.00

<b>Mode</b>	All
<b>Remote Command</b>	:SYSTem:TEMPerature:HEXTreme?
<b>Example</b>	:SYST:TEMP:HEXT?
<b>Notes</b>	Value is in degrees Celsius at which the highest operating temperature has been recorded since 1st power-up.
State Saved	No
Initial S/W Revision	Prior to A.02.00

### Query the Elapsed Time since 1<sup>st</sup> power on

Returns the elapsed on-time in minutes since 1st power-on.

<b>Remote Command</b>	:SYSTem:PON:ETIM?
<b>Example</b>	:SYST:PON:ETIM?
<b>Notes</b>	Query Only
<b>Initial S/W Revision</b>	Prior to A.02.00

### Advanced

Accesses advanced diagnostic capabilities performed in the factory or under instructions from repair procedures. This menu key is only visible when the logged-in user is "saservice".

**NOTE** This feature is not available if option SF1 is installed.

The first access to the Advanced Diagnostic Menu after invoking the instrument application will require an authentication, which is to enter the Service Code. Subsequent accesses to the Advanced Diagnostic Menu are unimpeded. The Authentication dialog looks like:

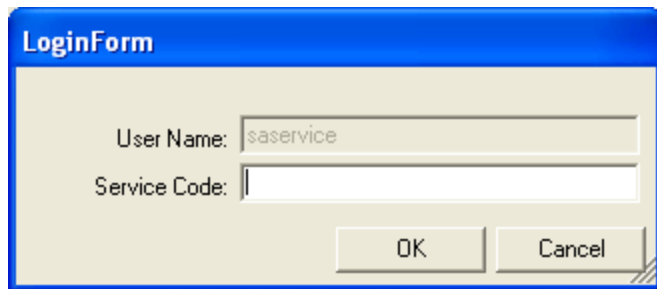

"OK" is the default key thus the Enter key is used to complete the entry. If invalid Service Code is entered authentication is not granted and you are provided the following dialog:

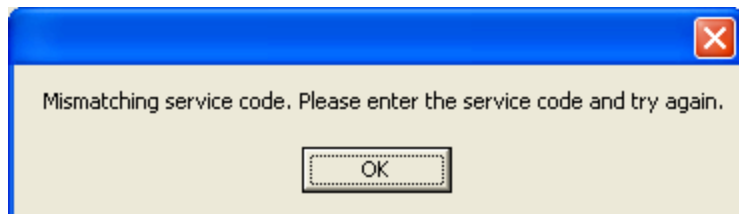

<b>Key Path</b>	System, Diagnostics
<b>Notes</b>	Password is required to access this menu.
<b>Initial S/W Revision</b>	Prior to A.02.00

	Agilent Converged	PSA
<b>IP Address</b>	SYSTem:COMMunicate:LAN:ADDRes <string> SYSTem:COMMunicate:LAN:ADDRes?	:SYSTem:COMMunicate:LAN[;SELF]:IP <string> :SYSTem:COMMunicate:LAN[;SELF]:IP?
<b>Gateway</b>	SYSTem:COMMunicate:LAN:DGATeway <string>	:SYSTem:COMMunicate:LAN[;SELF]:GATEWay <string>



	SYSTem:COMMunicate:LAN:DGATeway?	:SYSTem:COMMunicate:LAN[:SELF]:GATEway?
Subnet	SYSTem:COMMunicate:LAN:SMASk <string>	:SYSTem:COMMunicate:LAN[:SELF]:SUBNetmask <string>
Mask	SYSTem:COMMunicate:LAN:SMASk?	:SYSTem:COMMunicate:LAN[:SELF]:SUBNetmask?

## Internet Explorer...

This key launches Microsoft Internet Explorer. A mouse and external keyboard are highly desired for using Internet Explorer. When Internet Explorer is running, close Internet Explorer to return focus to the Instrument Application (or use Alt-Tab).

**NOTE**

This feature is not available if option SF1 is installed.

Key Path	System
Mode	All
Notes	No equivalent remote command for this key.
Initial S/W Revision	A.05.01

## System Remote Commands (Remote Commands Only)

The commands in this section have no front-panel key equivalent.

["System Powerdown \(Remote Command Only\)" on page 353](#)

["List installed Options \(Remote Command Only\)" on page 354](#)

["Lock the Front-panel keys \(Remote Command Only\)" on page 354](#)

["List SCPI Commands \(Remote Command Only\)" on page 354](#)

["SCPI Version Query \(Remote Command Only\)" on page 355](#)

["Date \(Remote Command Only\)" on page 355](#)

["Time \(Remote Command Only\)" on page 355](#)

Initial S/W Revision	Prior to A.02.00
----------------------	------------------

## System Powerdown (Remote Command Only)

<b>Remote Command</b>	SYSTem:PDOWn [NORMal FORCe]
Notes	Shuts down the instrument in the normal way (NORMal) or forced way (FORCe). In case there is another application with modified data pending for saving, the application prompt the user. The system waits until the user responds in the normal mode. It will go off after 20 seconds of wait in the force mode and all data will be lost.

### List installed Options (Remote Command Only)

Lists the installed options that pertain to the instrument (signal analyzer).

Mode	All
<b>Remote Command</b>	:SYSTem:OPTions?
<b>Example</b>	:SYST:OPT?
Notes	The return string is a comma separated list of the installed options. For example: "503,P03,PFR" :SYSTem:OPTions? and *OPT? are the same.
State Saved	No
Initial S/W Revision	Prior to A.02.00

### Lock the Front-panel keys (Remote Command Only)

Disables the instrument keyboard to prevent local input when the instrument is controlled remotely. Annunciation showing a "K" for 'Klock" (keyboard lock) alerts the local user that the keyboard is locked. Klock is similar to the GPIB Local Lockout function; namely that no front-panel keys are active with the exception of the Power Standby key. (The instrument is allowed to be turned-off if Klock is ON.) The Klock command is used in remote control situations where Local Lockout cannot be used.

Although primary intent of Klock is to lock-out the front panel, it will lock-out externally connected keyboards through USB. Klock has no effect on externally connected pointing devices (mice).

The front panel 'Local' key (Cancel/Esc) has no effect if Klock is ON.

Mode	All
<b>Remote Command</b>	:SYSTem:KLOCK OFF ON 0 1 :SYSTem:KLOCK?
<b>Example</b>	:SYST:KLOC ON
Notes	Keyboard lock remains in effect until turned-off or the instrument is power-cycled
Preset	Initialized to OFF at startup, unaffected by Preset
State Saved	No
Initial S/W Revision	Prior to A.02.00

### List SCPI Commands (Remote Command Only)

Outputs a list of the valid SCPI commands for the currently selected Mode.

<b>Remote Command</b>	:SYSTem:HELP:HEADers?
<b>Example</b>	:SYST:HELP:HEAD?
Notes	The output is an IEEE Block format with each command separated with the New-Line character (hex

	0x0A)
Initial S/W Revision	Prior to A.02.00

### SCPI Version Query (Remote Command Only)

Returns the SCPI version number with which the instrument complies. The SCPI industry standard changes regularly. This command indicates the version used when the instrument SCPI commands were defined.

<b>Remote Command</b>	:SYSTem:VERSion?
<b>Example</b>	:SYST:VERS?
Initial S/W Revision	Prior to A.02.00

### Date (Remote Command Only)

The recommended access to the Date, Time, and Time zone of the instrument is through the Windows native control (Control Panel or accessing the Task Bar). You may also access this information remotely, as shown in this command and Time (below).

Sets or queries the date in the instrument.

Mode	All
<b>Remote Command</b>	:SYSTem:DATE "<year>,<month>,<day>" :SYSTem:DATE?
<b>Example</b>	:SYST:DATE "2006,05,26"
Notes	<year> is the four digit representation of year. (for example, 2006) <month> is the two digit representation of year. (for example. 01 to 12) <day> is the two digit representation of day. (for example, 01 to 28, 29, 30, or 31) depending on the month and year Unless the current account has Power User or Administrator privileges, an error will be generated by this command and no action will be taken.
Initial S/W Revision	Prior to A.02.00

### Time (Remote Command Only)

Sets or queries the time in the instrument.

Mode	All
<b>Remote Command</b>	:SYSTem:TIME "<hour>,<minute>,<second>" :SYSTem:TIME?
<b>Example</b>	:SYST:TIME "13,05,26"

---

Notes	<hour> is the two digit representation of the hour in 24 hour format <minute> is the two digit representation of minute <second> is the two digit representation of second Unless the current account has Power User or Administrator privileges, an error will be generated by this command and no action will be taken.
Initial S/W Revision	Prior to A.02.00

---

## 7 Trigger Functions

## Trigger

Accesses a menu of keys to control the selection of the trigger source and the setup of each of the trigger sources. The analyzer is designed to allow triggering from a number of different sources, for example, Free Run, Video, External, RF Burst, and so forth.

The TRIG:SOURCe command (below) will specify the trigger source for the currently selected input (RF or I/Q). If you change inputs, the new input remembers the trigger source it was last programmed to for the current measurement, and uses that trigger source. You can directly set the trigger source for each input using the TRIGger:RF:SOURce and TRIGger:IQ:SOURce commands (later in this section). When in External Mixing, the analyzer uses the RF trigger source.

Note the inclusion of the <measurement> parameter in the command below. Because each measurement remembers its own Trigger Source, the command must be qualified with the measurement name. Note that for the Swept SA measurement this is not the case; for backwards compatibility, no <measurement> parameter is used when setting the Trigger Source for the Swept SA measurement.

See ["Trigger Source Presets" on page 359](#)

See ["RF Trigger Source" on page 362](#)

See ["I/Q Trigger Source" on page 363](#)

See ["More Information" on page 364](#)

Key Path	Front-panel key
<b>Remote Command</b>	<pre>:TRIGger:&lt;measurement&gt;[:SEquence]:SOURce EXTernal1   EXTernal2   IMMediate   LINE   FRAMe   RFBurst   VIDeo   IF   ALARm   LAN   IQMag   IDEMod   QDEMod   IINPut   QINPut   AIQMag   TV  :TRIGger:&lt;measurement&gt;[:SEquence]:SOURce?</pre> <p>where &lt;measurement&gt; is the measurement for which you wish to set the Source (blank for the Swept SA measurement)</p>
<b>Example</b>	<pre>TRIG:ACP:SOUR EXT1</pre> <p>Selects the external 1 trigger input for the ACP measurement and the selected input</p> <pre>TRIG:SOUR VID</pre> <p>Selects video triggering for the Swept SA (SANalyzer) measurement in the Spectrum Analyzer mode. For SAN, do not use the &lt;measurement&gt; keyword. Only send this form in the Spectrum Analyzer mode or you will get an Undefined Header error</p>
<b>Notes</b>	<p>Not all measurements have all the trigger sources available to them. Check the trigger source documentation for your specific measurement to see what sources are available.</p> <p>Not all trigger sources are available for each input. See the <a href="#">"RF Trigger Source" on page 362</a> and <a href="#">"I/Q Trigger Source" on page 363</a> commands for detailed information on which trigger sources are available for each input.</p> <p>Other trigger-related commands are found in the INITiate and ABORt SCPI command subsystems.</p> <p>*OPC should be used after requesting data. This will hold off any subsequent changes to the selected trigger source, until after the sweep is completed and the data is returned.</p> <p>Available ranges and presets can vary from mode to mode.</p>
<b>Dependencies</b>	<p>In some models, there is no second External input. In these models, the External 2 key is blanked and</p>

	the EXternal2 parameter will generate a "Hardware missing; Not available for this model number" message.
Preset	See table below
Status Bits/OPC dependencies	The Status Operation Register bit 5 "Waiting for Trigger" is set at the same time as the Sweeping or Measuring bit is set. It is cleared when the trigger actually occurs (that is, after the trigger event occurs and all the applicable trigger criteria have been met). A corresponding pop-up message ("Waiting for trigger") is generated if no trigger signal appears after approximately 2 sec. This message goes away when a trigger signal appears.
<b>Backwards Compatibility SCPI</b>	:TRIGger[:SEquence]:SOURce EXTernal For backward compatibility, the parameter EXTernal is mapped to EXTernal1
<b>Backwards Compatibility SCPI</b>	[:SENSe]:<measurement>:TRIGger:SOURce This backwards compatibility alias command is provided for ESA/PSA compatibility This backwards compatibility command does not apply to the Swept SA measurement, for that just use :TRIGger:SOURce This backwards compatibility command does not apply to the monitor spectrum, log plot and spot frequency measurements
<b>Backwards Compatibility SCPI</b>	[:SENSe]:<measurement>:TRIGger:SOURce IF In earlier instruments, the parameter IF was used by apps for the video trigger, so using the IF parameter selects VIDeo triggering. Sending IF in the command causes VID to be returned to a query.
<b>Backwards Compatibility SCPI</b>	[:SENSe]:ACPr:TRIGger:SOURce This backwards Compatibility SCPI command is provided to support the same functionality as [:SENSe]:ACPr:TRIGger:SOURce (PSA W-CDMA, PSA cdma2000 and PSA 1xEVDO) due to the fact that the ACPr node conflicts with the ACPower node.
Initial S/W Revision	Prior to A.02.00
Modified at S/W Revision	A.03.00

## Trigger Source Presets

Here are the Trigger Source Presets for the various measurements:

Meas	Mode	Preset for RF	Preset for IQ	Notes
Swept SA	SA	IMM	IQ not supported	
CHP	SA, WCDMA, C2K, WIMAX OFDMA, 1xEVDO, DVB-T/H, DTMB, LTE, LTETDD, CMMB, ISDB-T, Digital Cable TV, MSR	IMM	IQ not supported	
OBW	SA, WCDMA, C2K, WIMAX OFDMA,	1xEVDO: EXT1 others: IMM	IQ not supported	For 1xEVDO mode, the trigger source is coupled with the gate state, as well as the gate

	TD-SCDMA, 1xEVDO, LTE, LTETDD, CMMB, ISDB-T, MSR			source. When the trigger source changes to RFBurst, External1 or External2, the gate state is set to on, and the gate source is set identically with the trigger source. When the trigger source changes to IMMEDIATE, VIDEO, LINE, FRAME or IF, the gate state is set to off.
CCDF	SA, WCDMA, C2K, WIMAX OFDMA, TD-SCDMA, 1xEV-DO, DVB-T/H, DTMB, LTE, LTETDD, CMMB, ISDB-T, Digital Cable TV, MSR	WIMAX OFDMA: RFBurst LTETDD: BTS: External 1 MS: Periodic Timer TD-SCDMA and 1xEV-DO: BTS: External 1 MS: RFBurst SA, WCDMA, C2K, LTE, CMMB, ISDB-T, DVB-T/H, DTMB, Digital Cable TV, MSR: IMMEDIATE	TD-SCDMA and 1xEV-DO: BTS: External 1 MS: IQMag LTETDD: BTS: External 1 MS: Periodic Timer Others: IMM	For TD-SCDMA: Trigger source is coupled with radio device. When radio device changes to BTS, trigger source will be changed to EXTERNAL1. When radio device changes to MS, trigger source will be set as RFBurst for RF or IQ Mag for BBIQ. When TriggerSource is RFBurst or IQ Mag, Measure Interval is grayed out.
ACP	SA, WCDMA, C2K, WIMAX OFDMA, TD-SCDMA, 1xEVDO, DVB-T/H, DTMB, LTE, LTETDD, CMMB, ISDB-T, Digital Cable TV, MSR	IMM	IQ not supported	
Tx Power	SA, GSM, TD-SCDMA	SA, GSM: RFBurst TD-SCDMA: EXTERNAL	IMM	TD-SCDMA doesn't support the Line and Periodic Timer parameters. When the mode is TD-SCDMA, if the Radio Device is switched to BTS, the value will be changed to External 1 and if the Radio device is switched to MS, the value will be changed to RFBurst
SPUR	SA, WCDMA, C2K, WIMAX OFDMA, TD-SCDMA, 1xEV-DO, DVB-T/H, LTE, LTETDD, MSR	IMM	IQ not supported	
SEM	SA, WCDMA, C2K, WIMAX OFDMA, TD-SCDMA, 1xEVDO, DVB-	1xEVDO(BTS): EXTERNAL1 All others: IMMEDIATE	IQ not supported	



	T/H, DTMB, LTE, LTETDD, CMMB, ISDB-T, Digital Cable TV, MSR			
CDP	WCDMA	IMM	IMM	
RHO	WCDMA	IMM	IMM	
PCON	WCDMA	IMM	IMM	
QPSK	WCDMA, C2K, 1xEVDO	All except CDMA1xEVDO: IMMediate CDMA1xEVDO: EXT1	IMM	
MON	All except SA and BASIC	IMM	IQ not supported	
WAV		LTETDD: BTS: External 1 MS: Periodic Timer GSM/EDGE: RFBurst All others: IMMediate	LTETDD: BTS: External 1 MS: Periodic Timer GSM/EDGE: IQMag All others: IMMMediate	
PVT	WIMAXOFDMA	RFB	IMM	
EVM	WIMAXOFDMA, DVB-T/H, DTMB, LTE, LTETDD, CMMB, ISDB-T, Digital Cable TV	All but CMMB: IMM CMMB: Periodic Timer	All but CMMB: IMM CMMB: External 1	LTE, LTETDD supports Free Run, Video and External 1 only.
SPEC	BASIC	IMM	IMM	
LOG Plot	PN	IMM	IQ not supported	
Spot Freq	PN	IMM	IQ not supported	
GMSK PVT	EDGE/GSM	RFB	IMM	
GMSK PFER	EDGE/GSM	RFB	IQMag	
GMSK ORFS	EDGE/GSM	RF Burst	IQ not supported	
EDGE PVT	EDGE/GSM	RFB	IMM	

EDGE EVM	EDGE/GSM	RFB	IQMag
EDGE ORFS	EDGE/GSM	Periodic Timer	IQ not supported
Combined WCDMA	WCDMA	IMM	IQ not supported
Combined GSM	EDGE/GSM	RFB	IQ not supported
List Power Step	WCDMA, EDGE/GSM	IMM	IQ not supported
Transmit On/Off Power	LTETDD	LTETDD: BTS: External 1 MS: Periodic Timer	LTETDD: BTS: External 1 MS: Periodic Timer
Transmit Analysis	BLUETOOTH	RFB	IQ not supported
Adjacent Channel Power	BLUETOOTH	IMM	IQ not supported
LE In-band Emissions	BLUETOOTH	IMM	IQ not supported
EDR In-band Spurious Emissions	BLUETOOTH	Periodic Timer	IQ not supported
Conformance EVM	LTE, LTETDD, MSR	IMM	IMM

## RF Trigger Source

The RF Trigger Source command selects the trigger to be used for the specified measurement when RF is the selected input. The RF trigger source can be queried and changed even while another input is selected, but it is inactive until RF becomes the selected input.

Note the inclusion of the <measurement> parameter in the command below. Because each measurement remembers its own Trigger Source, the command must be qualified with the measurement name. Note that for the Swept SA measurement this is not the case; for backwards compatibility, no <measurement> parameter is used when setting the Trigger Source for the Swept SA measurement.

<b>Remote Command</b>	<code>:TRIGger:&lt;measurement&gt;[:SEquence]:RF:SOURce EXTernal1   EXTernal2   IMMEDIATE   LINE   FRAME   RFBurst   VIDEO   IF   ALARm   LAN   TV</code> <code>:TRIGger:&lt;measurement&gt;[:SEquence]:RF:SOURce?</code>
<b>Example</b>	<code>TRIG:ACP:RF:SOUR EXT1</code> Selects the external 1 trigger input for the ACP measurement and the RF input

	<p><b>TRIG:RF:SOUR VID</b></p> <p>Selects video triggering for the SANalyzer measurement and the RF input. For SAN, do not use the &lt;measurement&gt; keyword.</p>
Notes	<p>Not all measurements have all the trigger sources available to them. Check the trigger source documentation for your specific measurement to see what sources are available.</p> <p>Not all trigger sources are available for each input. For the RF Trigger Source, the following trigger sources are available:</p> <ul style="list-style-type: none"> <li>–IMMediate - free run triggering</li> <li>–VIDeo - triggers on the video signal level</li> <li>–LINE - triggers on the power line signal</li> <li>–EXTernal1 (or EXTernal) - triggers on an externally connected trigger source marked “Trigger 1 In” on the rear panel</li> <li>–EXTernal2 - triggers on an externally connected trigger source marked “Trigger 2 In” on the front panel. In some models, there is no second External input. In these models, the External 2 key is blanked and the EXTernal2 parameter will generate a “Hardware missing; Not available for this model number” message</li> <li>–RFBurst - triggers on the bursted frame</li> <li>–FRAMe - triggers on the periodic timer</li> <li>–IF (video) - same as video, for backwards compatibility only</li> </ul> <p>*OPC should be used after requesting data. This will hold off any subsequent changes to the selected trigger source, until after the sweep is completed and the data is returned.</p> <p>Available ranges, and presets can vary from mode to mode.</p>
Status Bits/OPC dependencies	<p>The Status Operation Register bit 5 "Waiting for Trigger" is set at the same time as the Sweeping or Measuring bit is set. It is cleared when the trigger actually occurs (that is, after the trigger event occurs and all the applicable trigger criteria have been met). A corresponding pop-up message ("Waiting for trigger") is generated if no trigger signal appears after approximately 2 sec. This message goes away when a trigger signal appears.</p>
Initial S/W Revision	Prior to A.02.00

## I/Q Trigger Source

This command selects the trigger to be used for the specified measurement when I/Q (which requires option BBA) is the selected input. The I/Q trigger source can be queried and changed even while another input is selected, but it is inactive until I/Q becomes the selected input.

<b>Remote Command</b>	<pre>:TRIGger:&lt;measurement&gt;[:SEquence]:IQ:SOURce EXTernal1   EXTernal2   IMMediate   IQMag   IDEMod   QDEMod   IINPut   QINPut   AIQMag  :TRIGger:&lt;measurement&gt;[:SEquence]:IQ:SOURce?</pre>
<b>Example</b>	<p><b>TRIG:WAVeform:SOUR IQM</b></p> <p>Selects I/Q magnitude triggering for the IQ Waveform measurement and the I/Q input</p>
Notes	<p>Not all measurements have all the trigger sources available to them. Check the trigger source documentation for your specific measurement to see what sources are available.</p> <p>Not all trigger sources are available for each input. For the I/Q Trigger Source, the following trigger sources are available:</p>

---

	<ul style="list-style-type: none"> <li>–IMMediate - free run triggering</li> <li>–EXTernal1 (or EXTernal) - triggers on an externally connected trigger source on the rear panel</li> <li>–EXTernal2 - triggers on an externally connected trigger source on the front panel</li> <li>–IQMag - triggers on the magnitude of the I/Q signal</li> <li>–IDEMod - triggers on the I/Q signal's demodulated I voltage</li> <li>–QDEMod - triggers on the I/Q signal's demodulated Q voltage</li> <li>–IINPut - triggers on the I channel's ADC voltage</li> <li>–QINPut - triggers on the Q channel's ADC voltage</li> <li>–AIQMag - triggers on the magnitude of the auxiliary receiver channel I/Q signal</li> </ul> <p>*OPC should be used after requesting data. This will hold off any subsequent changes to the selected trigger source, until after the sweep is completed and the data is returned.</p> <p>Available ranges, and from mode to mode presets can vary</p>
Status Bits/OPC dependencies	The Status Operation Register bit 5 "Waiting for Trigger" is set at the same time as the Sweeping or Measuring bit is set. It is cleared when the trigger actually occurs (that is, after the trigger event occurs and all the applicable trigger criteria have been met). A corresponding pop-up message ("Waiting for trigger") is generated if no trigger signal appears after approximately 2 sec. This message goes away when a trigger signal appears.
Initial S/W Revision	Prior to A.02.00

---

## More Information

The trigger menus let you select the trigger source and trigger settings for a sweep or measurement. In triggered operation (basically, any trigger source other than Free Run), the analyzer will begin a sweep or measurement only with the selected trigger conditions are met, generally when your trigger source signal meets the specified trigger level and polarity requirements. (In FFT measurements, the trigger controls when the data acquisition begins for FFT conversion.)

For each of the trigger sources, you may define a set of operational parameters or settings which will be applied when that source is selected as the current trigger source. Examples of these settings are Trigger Level, Trigger Delay, and Trigger Slope. You may apply different settings for each source; so, for example, you could have a Trigger Level of 1v for External 1 trigger and –10 dBm for Video trigger.

Once you have established the settings for a given trigger source, they generally will remain unchanged for that trigger source as you go from measurement to measurement within a Mode (although the settings do change as you go from Mode to Mode). Furthermore, the trigger settings within a Mode are the same for the **Trigger** menu, the **Gate Source** menu, and the **Sync Source** menu that is part of the **Periodic Timer Trigger Setup** menu. That is, if **Ext1** trigger level is set to 1v in the **Trigger** menu, it will appear as 1v in both the **Gate Source** and the **Sync Source** menus. For these reasons the trigger settings commands are not qualified with the measurement name, the way the trigger source commands are.

The settings setup menu can be accessed by pressing the key for the current trigger source a second time. For example, one press of Video selects the Video trigger as the source. The Video key becomes highlighted and the hollow arrow on the key turns black. Now a second press of the key takes you into the Video Trigger Setup menu.

Trigger Setup Parameters:

The following examples show trigger setup parameters using an external trigger source.

Example 1 illustrates the trigger conditions with negative slope and no trigger occurs during trigger Holdoff time.

Example 2 illustrates the trigger conditions with positive slope, trigger delay, and auto trigger time.

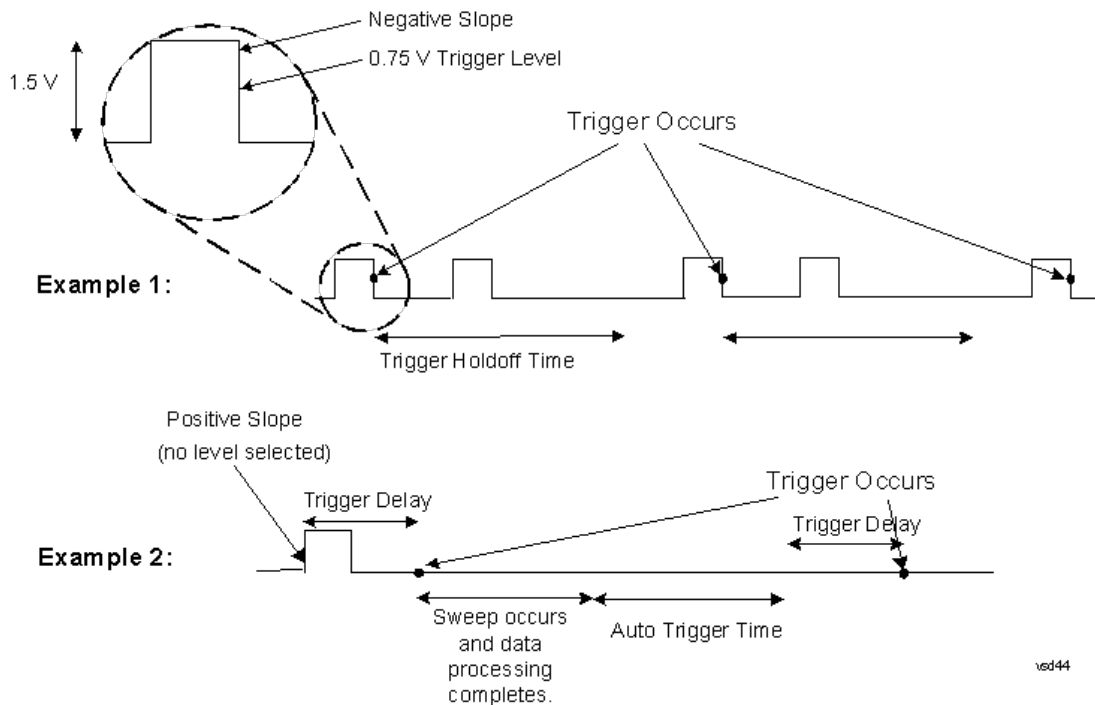

## Free Run

Pressing this key, when it is not selected, selects free-run triggering. Free run triggering occurs immediately after the sweep/measurement is initiated.

Key Path	Trigger
<b>Example</b>	TRIG:SOUR IMM Swept SA measurement TRIG:<meas>:SOUR IMM Measurements other than Swept SA
State Saved	Saved in instrument state
Status Bits/OPC dependencies	The Status Operation Register bit 5 "Waiting for Trigger" is set at the same time as the Sweeping or Measuring bit is set. It is cleared when the trigger actually occurs (that is, after the trigger event occurs and all the applicable trigger criteria have been met). A corresponding pop-up message ("Waiting for trigger") is generated if no trigger signal appears after approximately 2 sec. This message goes away when a trigger signal appears.
Initial S/W Revision	Prior to A.02.00

## Video (IF Envelope)

Pressing this key, when it is not selected, selects the video signal as the trigger. The Video trigger condition is met when the video signal (the filtered and detected version of the input signal, including both RBW and VBW filtering) crosses the video trigger level.

**NOTE**

When the detector selected for all active traces is the average detector, the video signal for triggering does not include any VBW filtering.

The video trigger level is shown as a labeled line on the display. The line is displayed as long as video is the selected trigger source.

Pressing this key, when it is already selected, accesses the video trigger setup functions.

Key Path	Trigger
<b>Example</b>	TRIG:SOUR VID Swept SA measurement TRIG:<meas>:SOUR VID Measurements other than Swept SA
Notes	Log Plot and Spot Frequency measurements do not support Video Trigger
Dependencies	Video trigger is allowed in average detector mode.
State Saved	Saved in instrument state
Status Bits/OPC dependencies	The Status Operation Register bit 5 "Waiting for Trigger" is set at the same time as the Sweeping or Measuring bit is set. It is cleared when the trigger actually occurs (that is, after the trigger event occurs and all the applicable trigger criteria have been met). A corresponding pop-up message ("Waiting for trigger") is generated if no trigger signal appears after approximately 2 sec. This message goes away when a trigger signal appears.
Backwards Compatibility Notes	In the past, the Average detector was not available when Video triggering was on, and consequently, functions that set the detector to average (such as Marker Noise or Band/Intvl Power) were not available when the video trigger was on. Similarly, Video triggering was not available when the detector was Average. In the X-Series, these restrictions are removed.
Initial S/W Revision	Prior to A.02.00

## Trigger Level

Sets a level for the video signal trigger. When the video signal crosses this level, with the chosen slope, the trigger occurs. This level is displayed with a horizontal line only if **Video** is the selected trigger source.

Key Path	Trigger, Video
<b>Remote Command</b>	:TRIGger[:SEquence]:VIDeo:LEVel <ampl> :TRIGger[:SEquence]:VIDeo:LEVel?
<b>Example</b>	TRIG:VID:LEV -40 dBm
Notes	When sweep type = FFT, the video trigger uses the amplitude envelope in a bandwidth wider than the FFT width as a trigger source. This might often be useful, but does not have the same relationship between the displayed trace and the trigger level as in swept triggering. Amplitude Corrections are not taken into account by the Video Trig Level. For example, if you have

given yourself effective gain with an amplitude correction factor, the Video Trigger will not fire until you have dropped the trigger line that far below the displayed signal level, rather than simply dropping it down to the displayed signal level.

Note that other corrections, specifically External Gain and Ref Level Offset, modify the actual trace data as it is taken and therefore ARE taken into account by Trig Level.

Couplings	This same level is used for the Video trigger source in the Trigger menu and for the Video selection in the Gate Source menu.
Preset	Set the Video Trigger Level -25 dBm on Preset. When the Video Trigger Level becomes the active function, if the value is off screen, set it to either the top or bottom of screen, depending on which direction off screen it was.
State Saved	Saved in instrument state
Min	-170 dBm
Max	+30 dBm
Default Unit	Depends on the current selected Y axis unit
<b>Backwards Compatibility SCPI</b>	:TRIGger[:SEquence]:IF:LEVel :TRIGger[:SEquence]:IF:LEVel?
Backwards Compatibility Notes	This alias is provided for backward compatibility with VSA/PSA comms apps.
Initial S/W Revision	Prior to A.02.00

## Trig Slope

Controls the trigger polarity. It is set positive to trigger on a rising edge and negative to trigger on a falling edge.

Key Path	Trigger, Video
<b>Remote Command</b>	:TRIGger[:SEquence]:VIDeo:SLOPe POSitive NEGative :TRIGger[:SEquence]:VIDeo:SLOPe?
<b>Example</b>	TRIG:VID:SLOP NEG
Preset	POSitive
State Saved	Saved in instrument state
<b>Backwards Compatibility SCPI</b>	:TRIGger[:SEquence]:IF:SLOPe NEGative POSitive :TRIGger[:SEquence]:IF:SLOPe?
Backwards Compatibility Notes	For backward compatibility with VSA/PSA comms apps The legacy :TRIGger[:SEquence]:SLOPe command affects the slopes for the VID, LINE, EXT1, EXT2, and RFB triggers.
Initial S/W Revision	Prior to A.02.00

<b>Remote Command</b>	:TRIGger[:SEquence]:SLOPe POSitive NEGative :TRIGger[:SEquence]:SLOPe?
<b>Example</b>	TRIG:SLOP NEG
<b>Preset</b>	POSitive
<b>State Saved</b>	Saved in instrument state
<b>Backwards Compatibility Notes</b>	In ESA/PSA, the Trigger Slope was global to all triggers. In the X-Series, the slope can be set individually for each Trigger Source. For backward compatibility, the global SLOPe command updates all instances of trigger slope (VID, LINE, EXT1, EXT2, TV, RFB). The query returns the trigger slope setting of the currently selected trigger source.
<b>Initial S/W Revision</b>	Prior to A.02.00

### Trig Delay

Controls a time delay during that the analyzer will wait to begin a sweep after meeting the trigger criteria. You can use negative delay to pre-trigger the instrument in the time domain or FFT, but not in swept spans.

<b>Key Path</b>	Trigger, Video
<b>Remote Command</b>	:TRIGger[:SEquence]:VIDeo:DELaY <time> :TRIGger[:SEquence]:VIDeo:DELaY? :TRIGger[:SEquence]:VIDeo:DELaY:STATe OFF ON 0 1 :TRIGger[:SEquence]:VIDeo:DELaY:STATe?
<b>Example</b>	TRIG:VID:DEL:STAT ON TRIG:VID:DEL 100 ms
<b>Notes</b>	Video trigger delay may be set to negative values, in time domain, FFT and even swept. It makes intuitive sense in time domain and works well in FFT mode where the bandwidth of the filter before the video trigger is about 1.25 span. In swept spans, negative settings of Trig Delay are treated as a zero setting within the internal hardware and the advisory message "Neg. Trig Delay unavailable in Swept Mode, zero delay used." is generated when such a delay is set.
<b>Preset</b>	Off, 1 us
<b>State Saved</b>	Saved in instrument state
<b>Min</b>	-150 ms
<b>Max</b>	+500 ms
<b>Default Unit</b>	s
<b>Backwards Compatibility Notes</b>	! For backward compatibility with VSA/PSA comms apps :TRIGger[:SEquence]:IF:DELaY :TRIGger[:SEquence]:DELaY The legacy :TRIGger[:SEquence]:DELaY command affects the delay for the VID, LINE, EXT1, EXT2, and RFB triggers.
<b>Initial S/W Revision</b>	Prior to A.02.00



<b>Remote Command</b>	:TRIGger[:SEquence]:DELay <time> :TRIGger[:SEquence]:DELay? :TRIGger[:SEquence]:DELay:STATE OFF ON 0 1 :TRIGger[:SEquence]:DELay:STATE?
<b>Example</b>	TRIG:DEL 1 ms
<b>Preset</b>	1 us
<b>State Saved</b>	Saved in instrument state
<b>Backwards Compatibility Notes</b>	In ESA/PSA, the Trigger Delay was global to all triggers. In the X-Series, the delay can be set individually for each Trigger Source. For backward compatibility, the global DELay command updates all instances of trigger slope (VID, LINE, EXT1, EXT2) except TV and RFBurst. The query returns the trigger delay setting of the currently selected trigger source.
<b>Initial S/W Revision</b>	Prior to A.02.00

<b>Remote Command</b>	:TRIGger[:SEquence]:OFFSet <time> :TRIGger[:SEquence]:OFFSet? :TRIGger[:SEquence]:OFFSet:STATE OFF ON 0 1 :TRIGger[:SEquence]:OFFSet:STATE?
<b>Example</b>	TRIG:OFFS ON TRIG:OFFS -100 ms
<b>Notes</b>	These are ESA commands for trigger offset that allowed you to use a positive or negative delay when in zero span and in a Res BW $\geq$ 1 kHz. For ESA compatibility, X-series analyzers keep track of this offset and adds it to the Trigger Delay for VIDEo, LINE, EXTernal1 or EXTernal2 whenever the value is sent to the hardware, if in Zero Span and RBW $\geq$ 1 kHz.
<b>Preset</b>	Off, 0 s
<b>State Saved</b>	Saved in instrument state
<b>Min</b>	-11 s
<b>Max</b>	+11 s
<b>Initial S/W Revision</b>	Prior to A.02.00

## External 1

Pressing this key, when it is not selected, selects an external input signal as the trigger. A new sweep/measurement will start when the external trigger condition is met using the external 1 input connector on the rear panel.

Pressing this key, when it is already selected, accesses the external 1 trigger setup menu.

<b>Key Path</b>	Trigger
<b>Example</b>	TRIG:SOUR EXT1 Swept SA measurement TRIG:<meas>:SOUR EXT1 Measurements other than Swept SA

Dependencies	Grayed out if in use by Point Trigger in the Source Setup menu. Forced to Free Run if already selected and Point Trigger is set to External 1.
State Saved	Saved in instrument state
Status Bits/OPC dependencies	The Status Operation Register bit 5 "Waiting for Trigger" is set at the same time as the Sweeping or Measuring bit is set. It is cleared when the trigger actually occurs (that is, after the trigger event occurs and all the applicable trigger criteria have been met). A corresponding pop-up message ("Waiting for trigger") is generated if no trigger signal appears after approximately 2 sec. This message goes away when a trigger signal appears.
Initial S/W Revision	Prior to A.02.00

## Trigger Level

Sets the value where the external 1 trigger input will trigger a new sweep/measurement.

Key Path	Trigger, External 1
<b>Remote Command</b>	:TRIGger[:SEquence]:EXTernal1:LEVel <level> :TRIGger[:SEquence]:EXTernal1:LEVel?
<b>Example</b>	TRIG:EXT1:LEV 0.4 V
Couplings	This same level is used for the Ext1 trigger source in the Trigger menu, for the Ext1 selection in the Periodic Timer sync source (in the Trigger menu and in the Gate Source menu), and also for the Ext1 selection in the Gate Source menu.
Preset	1.2 V
State Saved	Saved in instrument state
Min	-5 V
Max	5 V
Default Unit	V
<b>Backwards Compatibility SCPI</b>	:TRIGger[:SEquence]:EXTernal:LEVel For backward compatibility, the parameter EXTernal is mapped to EXTernal1
<b>Backwards Compatibility SCPI</b>	:TRIGger[:SEquence]:FRAMe:EXTernal1:LEVel
Initial S/W Revision	Prior to A.02.00

## Trig Slope

Controls the trigger polarity. It is set positive to trigger on a rising edge and negative to trigger on a falling edge.

Key Path	Trigger, External 1
<b>Remote Command</b>	:TRIGger[:SEquence]:EXTernal1:SLOPe POSitive NEGative

	:TRIGger[:SEQuence]:EXTernal1:SLOPe?
<b>Example</b>	TRIG:EXT1:SLOP NEG
Couplings	This same slope is used in the Ext1 selection for the trigger source in the Trigger menu and for the period timer sync source (in the Trigger menu and in the Gate Source menu).
Preset	POSitive
State Saved	Saved in instrument state
<b>Backwards Compatibility SCPI</b>	:TRIGger[:SEQuence]:EXTernal:SLOPe For backward compatibility, the parameter EXTernal is mapped to EXTernal1
<b>Backwards Compatibility SCPI</b>	:TRIGger[:SEQuence]:FRAMe:EXTernal1:SLOPe
Backwards Compatibility Notes	The legacy :TRIGger[:SEQuence]:SLOPe command affects the slopes for the VID, LINE, EXT1, EXT2, and RFB triggers.
Initial S/W Revision	Prior to A.02.00

## Trig Delay

Controls a time delay during which the analyzer will wait to begin a sweep after meeting the trigger criteria. You can use negative delay to pre-trigger the instrument in time domain or FFT, but not in swept spans.

Key Path	Trigger, External 1
<b>Remote Command</b>	:TRIGger[:SEQuence]:EXTernal1:DELAy <time> :TRIGger[:SEQuence]:EXTernal1:DELAy? :TRIGger[:SEQuence]:EXTernal1:DELAy:STATe OFF ON 0 1 :TRIGger[:SEQuence]:EXTernal1:DELAy:STATe?
<b>Example</b>	TRIG:EXT1:DEL:STAT ON TRIG:EXT1:DEL 100 ms
Notes	Video trigger delay may be set to negative values, in time domain, FFT and even swept. It makes intuitive sense in time domain and works well in FFT mode where the bandwidth of the filter before the video trigger is about 1.25 span. In swept spans, negative settings of Trig Delay are treated as a zero setting within the internal hardware and the advisory message "Neg. Trig Delay unavailable in Swept Mode, zero delay used." is generated when such a delay is set.
Preset	Off, 1.000 us
State Saved	Saved in instrument state
Min	-150 ms
Max	+500 ms
Default Unit	s
<b>Backwards Compatibility SCPI</b>	:TRIGger[:SEQuence]:EXTernal:DELAy For backward compatibility, the parameter EXTernal is mapped to EXTernal1
Backwards Compatibility	The legacy :TRIGger[:SEQuence]:DELAy command affects the delay for the VID, LINE, EXT1, EXT2,

Notes	and RFB triggers. The legacy :TRIGger[:SEQuence]:OFFSet command is supported for the VIDEO, LINE, EXT1, and EXT2 triggers.
Initial S/W Revision	Prior to A.02.00

## Zero Span Delay Comp On/Off

In zero span, there is a natural delay in the signal path, which comes from the RBW filter. This is usually desirable, as it allows you to trigger on events and also see those events, because the signal is delayed from the trigger event. However, in some cases it is desirable to eliminate this delay, so that trigger events line up exactly with the zero time point in zero span. You can use the Zero Span Delay Comp On/Off feature to enable or disable zero span delay compensation.

Key Path	Trigger, External 1
Remote Command	:TRIGger[:SEQuence]:EXTernal1:DELY:COMPensation OFF ON 0 1 :TRIGger[:SEQuence]:EXTernal1:DELY:COMPensation?
Example	TRIG:EXT1:DEL:COMP ON
Dependencies	No effect except in zero-span, but not locked out in nonzero spans. Blanked in modes that do not support zero-span measurements. If the SCPI command is sent when the key is blanked, an error is returned: -221, "Settings conflict; Feature not supported for this measurement" In analyzers shipping N9060A, this feature requires N9060A-7FP.
Preset	OFF
State Saved	Saved in instrument state
Initial S/W Revision	A.11.00

## External 2

Pressing this key, when it is not selected, selects an external input signal as the trigger. A new sweep/measurement will start when the external trigger condition is met using the external 2 input connector. The external trigger 2 input connector is on the rear panel.

Pressing this key, when it is already selected, accesses the external 2 trigger setup menu.

Key Path	Trigger
Example	TRIG:SOUR EXT2 Swept SA measurement TRIG:<meas>:SOUR EXT2 Measurements other than Swept SA
Dependencies	In some models, there is no second External input. In these models, the External 2 key is blanked and the EXTernal2 parameter will generate a "Hardware missing; Not available for this model number" message. Grayed out if in use by Point Trigger in the Source Setup menu. Forced to Free Run if already selected and Point Trigger is set to External 2.

State Saved	Saved in instrument state
Status Bits/OPC dependencies	The Status Operation Register bit 5 "Waiting for Trigger" is set at the same time as the Sweeping or Measuring bit is set. It is cleared when the trigger actually occurs (that is, after the trigger event occurs and all the applicable trigger criteria have been met). A corresponding pop-up message ("Waiting for trigger") is generated if no trigger signal appears after approximately 2 sec. This message goes away when a trigger signal appears.
Initial S/W Revision	Prior to A.02.00
Modified at S/W Revision	A.03.00

## Trigger Level

Sets the value where the external 2 trigger input will trigger a new sweep/measurement.

Key Path	Trigger, External 2
<b>Remote Command</b>	:TRIGger[:SEquence]:EXTernal2:LEVel :TRIGger[:SEquence]:EXTernal2:LEVel?
<b>Example</b>	TRIG:EXT2:LEV 1.1 V
Couplings	This same level is used for the Ext2 trigger source in the Trigger menu, for the Ext2 selection in the Periodic Timer sync source (in the Trigger menu and in the Gate Source menu), and also for the Ext2 selection in the Gate Source menu.
Preset	1.2 V
State Saved	Saved in instrument state
Min	-5 V
Max	5 V
Default Unit	V
<b>Backwards Compatibility SCPI</b>	:TRIGger[:SEquence]:FRAMe:EXTernal2:LEVel
Initial S/W Revision	Prior to A.02.00

## Trig Slope

Controls the trigger polarity. It is set positive to trigger on a rising edge and negative to trigger on a falling edge.

Key Path	Trigger, External 2
<b>Remote Command</b>	:TRIGger[:SEquence]:EXTernal2:SLOPe POSitive NEGative :TRIGger[:SEquence]:EXTernal2:SLOPe?
<b>Example</b>	TRIG:EXT2:SLOP NEG
Couplings	This same slope is used in the Ext2 selection for the trigger source in the Trigger menu and for the period timer sync source (in the Trigger menu and in the Gate Source menu).

Preset	POSitive
State Saved	Saved in instrument state
<b>Backwards Compatibility SCPI</b>	:TRIGger[:SEQuence]:FRAMe:EXTernal2:SLOPe
Backwards Compatibility Notes	The legacy :TRIGger[:SEQuence]:SLOPe command affects the slopes for the VID, LINE, EXT1, EXT2, and RFB triggers.
Initial S/W Revision	Prior to A.02.00

## Trig Delay

Controls a time delay during which the analyzer will wait to begin a sweep after meeting the trigger criteria. You can use negative delay to pre-trigger the instrument in time domain or FFT, but not in swept spans.

Key Path	Trigger, External 2
<b>Remote Command</b>	:TRIGger[:SEQuence]:EXTernal2:DELay <time> :TRIGger[:SEQuence]:EXTernal2:DELay? :TRIGger[:SEQuence]:EXTernal2:DELay:STATe OFF ON 0 1 :TRIGger[:SEQuence]:EXTernal2:DELay:STATe?
<b>Example</b>	TRIG:EXT2:DEL:STAT ON TRIG:EXT2:DEL 100 ms
Notes	Video trigger delay may be set to negative values, in time domain, FFT and even swept. It makes intuitive sense in time domain and works well in FFT mode where the bandwidth of the filter before the video trigger is about 1.25 span. In swept spans, negative settings of Trig Delay are treated as a zero setting within the internal hardware and the advisory message "Neg. Trig Delay unavailable in Swept Mode, zero delay used." is generated when such a delay is set.
Preset	Off, 1.000 us
State Saved	Saved in instrument state
Min	-150 ms
Max	500 ms
Default Unit	s
Backwards Compatibility Notes	The legacy :TRIGger[:SEQuence]:DELay command affects the delay for the VID, LINE, EXT1, EXT2, and RFB triggers. The legacy :TRIGger[:SEQuence]:OFFSet command is supported for the VIDEo, LINE, EXT1, and EXT2 triggers.
Initial S/W Revision	Prior to A.02.00

## Zero Span Delay Comp On/Off

In zero span, there is a natural delay in the signal path, which comes from the RBW filter. This is usually desirable, as it allows you to trigger on events and also see those events, because the signal is delayed

from the trigger event. However, in some cases it is desirable to eliminate this delay, so that trigger events line up exactly with the zero time point in zero span. You can use the Zero Span Delay Comp On/Off feature to enable or disable zero span delay compensation.

Key Path	Trigger, External 2
Remote Command	:TRIGger[:SEquence]:EXTernal2:DELay:COMPensation OFF ON 0 1 :TRIGger[:SEquence]:EXTernal2:DELay:COMPensation?
Example	TRIG:EXT2:DEL:COMP ON
Dependencies	No effect except in zero-span, but not locked out in nonzero spans. Blanked in modes that do not support zero-span measurements. If the SCPI command is sent when the key is blanked, an error is returned: -221, "Settings conflict; Feature not supported for this measurement" In analyzers shipping N9060A, this feature requires N9060A-7FP.
Preset	OFF
State Saved	Saved in instrument state
Initial S/W Revision	A.11.00

## Auto/Holdoff

Opens up a menu that lets you adjust Auto Trigger and Trigger Holdoff parameters

Key Path	Trigger
Readback line	Displays a summary of the Auto Trig and Holdoff settings, in square brackets First line: Auto Off or Auto On Second Line: "Hldf" followed by: <ul style="list-style-type: none"> <li>• If Holdoff is Off, readback Off</li> <li>• If Holdoff On and Type = Normal, readback value</li> <li>• If Holdoff On and Type = Above, readback value followed by AL</li> <li>• If Holdoff On and Type = Below, readback value followed by BL</li> <li>• If Holdoff Type selection is not supported by the current measurement, Holdoff Type is always Normal</li> </ul>
Initial S/W Revision	A.02.00

## Auto Trig

Sets the time that the analyzer will wait for the trigger conditions to be met. If they are not met after that much time, then the analyzer is triggered anyway.

Key Path	Trigger, Auto/Holdoff
Remote Command	:TRIGger[:SEquence]:ATRigger <time> :TRIGger[:SEquence]:ATRigger? :TRIGger[:SEquence]:ATRigger:STATE OFF ON 0 1

	:TRIGger[:SEquence]:ATRigger:STATe?
<b>Example</b>	TRIG:ATR:STAT ON TRIG:ATR 100 ms
Notes	The "time that the analyzer will wait" starts when the analyzer is ready for a trigger, which may be hundreds of ms after the data acquisition for a sweep is done. The "time" ends when the trigger condition is satisfied, not when the delay ends.
Preset	Off, 100 ms
State Saved	Saved in instrument state
Min	1 ms
Max	100 s
Default Unit	s
Initial S/W Revision	Prior to A.02.00

### Trig Holdoff

Sets the holdoff time between triggers. When the trigger condition is satisfied, the trigger occurs, the delay begins, and the holdoff time begins. New trigger conditions will be ignored until the holdoff time expires. For a free-running trigger, the holdoff value is the minimum time between triggers.

Key Path	Trigger, Auto/Holdoff
<b>Remote Command</b>	:TRIGger[:SEquence]:HOLDoff <time> :TRIGger[:SEquence]:HOLDoff? :TRIGger[:SEquence]:HOLDoff:STATe OFF ON 0 1 :TRIGger[:SEquence]:HOLDoff:STATe?
<b>Example</b>	TRIG:HOLD:STAT ON TRIG:HOLD 100 ms
Dependencies	Unavailable if the selected Input is BBIQ. If this is the case, the key is grayed out if it is pressed the informational message "Feature not supported for this Input" is displayed. If the SCPI command is sent, the error "Settings conflict; Feature not supported for this Input" is generated.
Preset	Off, 100 ms
State Saved	Saved in instrument state
Min	0 s
Max	0.5 s
Default Unit	s
Initial S/W Revision	Prior to A.02.00



## 8 Frequency Scan Measurement

In the Frequency Scan measurement, the analyzer scans the band using the specified Range Table settings. The scanning can be Smooth (Swept), or Discrete (Stepped) or Time Domain. You can select up to three traces using different detectors simultaneously. Next, the measurement uses the Peak Excursion and Peak Threshold values, and optionally the margin to determine which peak to report. A maximum of 2000 peaks can be recorded for one measurement.

For each of the peaks in the list, a final measurement will be performed using final detectors. This measurement provides up to three final detectors. Those with a final measurement amplitude greater than the limit will be denoted by a red limit delta in the signal list table.

**This topic contains the following sections:**

["Measurement Commands for Frequency Scan" on page 378](#)

["Remote Command Results for Frequency Scan" on page 379](#)

["Measurement Description" on page 380](#)

## Measurement Commands for Frequency Scan

CONFigure:FSCan

CONFigure:FSCan:NDEFault

CONFigure?

INITiate:FSCan

FETCh:FSCan [n] ?

MEASure:FSCan [n] ?

READ:FSCan [n] ?

## Remote Command Results for Frequency Scan

Command	n	Return Value
INITiate:FSCan	n/a	n/a
CONFigure?	n/a	name of current measurement: "FSCan"
CONFigure:FSCan	n/a	n/a (selects FSC measurement in Meas Preset state)
CONFigure:FSCan:NDEFault	n/a	n/a (selects FSC measurement without affecting settings)
FETCh:FSCan[n]? MEASure:FSCan[n]? READ:FSCan[n]?	not specified or n=1	Returns a comma separated list containing detailed information in the following format: <ul style="list-style-type: none"> <li>• Number of Peak Signal in the following list (integer)</li> </ul> [Repeats the following for each peak] <ul style="list-style-type: none"> <li>• Signal#</li> <li>• Trace# where peak is located</li> <li>• Frequency</li> <li>• Amplitude of Detector 1</li> <li>• Amplitude of Detector 2</li> <li>• Amplitude of Detector 3</li> <li>• Detector 1 vs. Limit Delta (A positive value denote a fail point)</li> <li>• Detector 2 vs. Limit Delta (A positive value denote a fail point)</li> <li>• Detector 3 vs. Limit Delta (A positive value denote a fail point)</li> </ul> If there is no value of amplitude or detector limit delta in the signal list, value 9.91e37 ("not a number") will be returned.
	2	This query returns Trace 1 data as a list of x,y pairs. The y-values are in the current Y Axis Unit of the instrument. The x-axis values are the values of the trace, in the x-axis scale units of the trace (Hz for frequency domain traces, seconds for time domain traces).  When querying trace data, it is best if the instrument is not sweeping during the query. Therefore, it is good to be in Single Sweep, or Update=Off when querying trace data from the instrument.
	3	Returns Trace 2 data as a series of x,y pairs
	4	Returns Trace 3 data as a series of x,y pairs

The Frequency Scan measurement is intended to be used for compliance or precompliance EMI measurement. The display consists of a conventional spectrum graticule display, meters, and signal list at the bottom.

Key Path	Meas
Initial S/W Revision	A.07.00

## Measurement Description

A complete Frequency Scan measurement consists of a series of routines, i.e. scanning, search and, a final measurement.

First, the measurement scans the band based on Scan Table settings specified and activated by the user to capture the interference spectrum. You can set up to ten ranges in the Scan Table. You can have up to three traces running with different detectors and trace types. You can enable limit lines that the spectrums need to meet, and optionally include a limit margin.

Next, the measurement will search for the peak signal. The search is based on the peak excursion and peak threshold setting that you define. You may optionally include a limit margin for the search. This process is also known as the data reduction stage. There will be a cross mark added onto the trace for each peak signal found.

For each of the peak signals found, the instrument will be tuned to the signal frequency in zero span and dwells for the dwell time specified. Since EMI standards usually specify limits for different detectors, you may specify up to a maximum of three final detectors. Each detector can have its own dwell time settings. Each signal in the list will be updated with the final detector and delta limit values when the final measurement is completed.

In some cases, you may not want to run the complete Frequency Scan measurement, so you have the flexibility to control the measurement routines. You can choose just to run scan, search, or the final measurement on a measured trace, or re-measure for only certain specific signals in the list.

Alternatively, you can perform the measurement using the measure at marker function. If a marker has been turned on, the measurement is performed at the marker position. If no marker is present on the screen, then one is turned on and placed on the highest peak on the screen. Similar to the final measurement, the measure at marker function consists of making a zero span measurement on each peak using the specified final measurement detectors and dwell times

You can export both scan table and signal list results for analysis. The exported scan table and signal list can be easily imported into the measurement. The data in the signal list table are persistent, which survives a mode preset and power cycle. Manipulation of a signal list such as the sorting a signal display, deleting a signal, marking a signal in the list, and copying a signal list are available.

## AMPTD Y Scale

Displays the menu keys that enable you to control the amplitude parameters.

Key Path	Front-panel key
Notes	Front-panel access only.
Initial S/W Revision	A.07.00

## Ref Level

Specifies the amplitude represented by the topmost graticule line.

Key Path	AMPTD Y Scale
<b>Remote Command</b>	:DISPlay:FSCan:VIEW[1]:WINDow[1]:TRACe:Y[:SCALe]:RLEVel <real> :DISPlay:FSCan:VIEW[1]:WINDow[1]:TRACe:Y[:SCALe]:RLEVel?
<b>Example</b>	DISP:FSC:VIEW:WIND:TRAC:Y:RLEV 10dBuV DISP:FSC:VIEW:WIND:TRAC:Y:RLEV?
Couplings	If you reduce the attenuation, the instrument may have to lower the reference level to keep it below its allowed maximum. This allowed maximum level is specified in the “Max” row, below, along with other variables that affect it. When you increase attenuation, the reference level does not change.
Preset	106.99 dBuV
State Saved	Saved in instrument state.
Min	RefLevelMin = -63.01 dBuV + RefLevelOffset - ExtGain.
Max	RefLevelMax = 206.99 dBuV + RefLevelOffset - External Gain
Default Unit	Depends on the current selected Y axis unit
Initial S/W Revision	A.07.00

## Attenuation

Enables you to set the value of the Attenuation parameter. This key only affects the Mechanical Attenuator in the EMI Receiver mode and has no Auto setting.

For the Frequency Scan measurement, this key only affects the attenuation used for meters.

The following amplitude parameters are not settable by the user and therefore do not appear in any menus:

Elec Attenuator	Disabled
Elec Attenuation	0dB
Meas Atten Step	2dB
Max Mixer Level	-10dBm

<b>Key Path</b>	AMPTD Y Scale
<b>Remote Command</b>	<code>[ :SENSe ] :POWeR [ :RF ] :ATTenuation &lt;rel_ampl&gt;</code> <code>[ :SENSe ] :POWeR [ :RF ] :ATTenuation?</code>
<b>Example</b>	POW:ATT 10 POW:ATT?
<b>Preset</b>	10 dB
<b>State Saved</b>	Saved in instrument state.
<b>Min</b>	0 dB
<b>Max</b>	50 dB (CXA) 60 dB (EXA) 70 dB (MXA, PXA& N9038A)
<b>Default Unit</b>	dB
<b>Backwards Compatibility SCPI</b>	<code>:INPut [1]   2 :ATTenuation</code>
<b>Backwards Compatibility SCPI Notes</b>	This command above is included for ESU compatibility. The suffix [1] 2 is irrelevant to the measurement, they are added solely for remote language compatibility. This SCPI is Meas Local and Context Sensitive.
<b>Initial S/W Revision</b>	A.07.00

## Scale/ Div

Sets the units per division of the vertical scale in the logarithmic display.

<b>Key Path</b>	AMPTD Y Scale
<b>Remote Command</b>	<code>:DISPlay:FSCan:VIEW[1]:WINDow[1]:TRACe:Y[:SCALe]:PDIVision &lt;rel_ampl&gt;</code> <code>:DISPlay:FSCan:VIEW[1]:WINDow[1]:TRACe:Y[:SCALe]:PDIVision?</code>
<b>Example</b>	DISP:FSC:VIEW:WIND:TRAC:Y:PDIV 5 dB DISP:FSC:VIEW:WIND:TRAC:Y:PDIV?
<b>Preset</b>	10.00 dB
<b>State Saved</b>	Saved in instrument state.
<b>Min</b>	0.10 dB
<b>Max</b>	20 dB
<b>Default Unit</b>	dB
<b>Initial S/W Revision</b>	A.07.00

## Presel Center

When this key is pressed, the centering of the preselector filter is adjusted to optimize the amplitude accuracy at the frequency of the selected marker. If the selected marker is not on when Presel Center is pressed, the analyzer will turn on the selected marker, perform a peak search, and then perform centering on the marker's center frequency. If the selected marker is already on and between the start and stop frequencies of the analyzer, the analyzer performs the preselector calibration on that marker's frequency. If the selected marker is already on, but outside the frequency range between Start Freq and Stop Freq, the analyzer will first perform a peak search, and then perform centering on the marker's center frequency.

The value displayed on the Presel Adjust key will change to reflect the new preselector tuning (see Presel Adjust).

A number of considerations should be observed to ensure proper operation. See ["Proper Preselector Operation" on page 383](#).

Key Path	AMPTD Y Scale
Remote Command	[ :SENSe] :POWer [ :RF] :PCENter
Example	POW:PCEN
Notes	Note that the rules outlined above under the key description apply for the remote command as well as the key. The result of the command is dependent on marker position, and so forth. Any message shown by the key press is also shown in response to the remote command.
Dependencies	<ul style="list-style-type: none"> <li>• Grayed out if the microwave preselector is off. )</li> <li>• If the selected marker's frequency is below Band 1, advisory message 0.5001 is generated and no action is taken.</li> <li>• Grayed out if entirely in Band 0.</li> <li>• Blank in models that do not include a preselector, such as option 503. If the SCPI is sent in these instruments, it is accepted without error, and the query always returns 0.</li> <li>• Grayed out in the Spectrogram View.</li> </ul>
Couplings	<p>The active marker position determines where the centering will be attempted.</p> <p>If the analyzer is in a measurement such as averaging when centering is initiated, the act of centering the preselector will restart averaging but the first average trace will not be taken until the centering is completed.</p>
Status Bits/OPC dependencies	<p>When centering the preselector, *OPC will not return true until the process is complete and a subsequent measurement has completed, nor will results be returned to a READ or MEASure command.</p> <p>The Measuring bit should remain set while this command is operating and should not go false until the subsequent sweep/measurement has completed.</p>
Initial S/W Revision	Prior to A.02.00
Modified at S/W Revision	A.03.00

## Proper Preselector Operation

A number of considerations should be observed to ensure proper operation:

1. If the selected marker is off, the analyzer will turn on a marker, perform a peak search, and adjust the preselector using the selected marker's frequency. It uses the "highest peak" peak search method unqualified by threshold or excursion, so that there is no chance of a 'no peak found' error. It continues with that peak, even if it is the peak of just noise. Therefore, for this operation to work properly, there should be a signal on screen in a preselected range for the peak search to find.
2. If the selected marker is already on, the analyzer will attempt the centering at that marker's frequency. There is no preselector for signals below about 3.6 GHz, therefore if the marker is on a signal below 3.6 GHz, no centering will be attempted and an advisory message generated
3. In some models, the preselector can be bypassed. If it is bypassed, no centering will be attempted in that range and a message will be generated.

### Preselector Adjust

Allows you to manually adjust the preselector filter frequency to optimize its response to the signal of interest. This function is only available when "Presel Center" on page 897 is available.

For general purpose signal analysis, using Presel Center is recommended. Centering the filter minimizes the impact of long-term preselector drift. Presel Adjust can be used instead to manually optimize the preselector. One application of manual optimization would be to peak the preselector response, which both optimizes the signal-to-noise ratio and minimizes amplitude variations due to small (short-term) preselector drifting.

Key Path	AMPTD Y Scale
Scope	Meas Global
Remote Command	[ :SENSe ] : POWer [ :RF ] : PADJust <freq> [ :SENSe ] : POWer [ :RF ] : PADJust?
Example	POW:PADJ 100KHz POW:PADJ?
Notes	The value on the key reads out to 0.1 MHz resolution.
Dependencies	<ul style="list-style-type: none"> <li>• Grayed out if microwave preselector is off. )</li> <li>• Grayed out if entirely in Band 0.</li> <li>• Blank in models that do not include a preselector, such as option 503. If the SCPI is sent in these instruments, it is accepted without error, and the query always returns 0.</li> <li>• Grayed out in the Spectrogram View.</li> </ul>
Preset	0 MHz
State Saved	The Presel Adjust value set by Presel Center, or by manually adjusting Presel Adjust, is not saved in instrument state, and does not survive a Preset or power cycle.
Min	-500 MHz
Max	500 MHz
Default Unit	Hz
Backwards Compatibility SCPI	[ :SENSe ] : POWer [ :RF ] : MW : PADJust [ :SENSe ] : POWer [ :RF ] : MMW : PADJust



	PSA had multiple preselectors, but the X-Series has only one. These commands simply alias to [:SENSe]:POWer[:RF]:PADJust
Initial S/W Revision	Prior to A.02.00
Modified at S/W Revision	A.03.00

<b>Remote Command</b>	[:SENSe]:POWer[:RF]:PADJust:PRESelector MWAVE   MMWave   EXTERNAL [:SENSe]:POWer[:RF]:PADJust:PRESelector?
Notes	PSA had multiple preselectors, and you could select which preselector to adjust. Since the X-Series has only one mm/uW preselector, the preselector selection softkey is no longer available. However, to provide backward compatibility, we accept the legacy remote commands. The command form has no effect, the query always returns MWAVE
Initial S/W Revision	Prior to A.02.00

## Y Axis Unit

Displays the menu keys that enable you to change the vertical (Y) axis amplitude unit. The analyzer retains the entered Y Axis Unit separately for both Log and Lin amplitude scale types. For example, if Scale Type has been set to Log, and you set Y Axis Unit to dBm, pressing Scale Type (Log) sets the Y Axis Unit to dBm. If Scale Type has been set to Lin and you set Y Axis Unit to V, pressing Scale Type (Lin) sets the Y Axis Unit to V. Pressing Scale Type (Log) again sets the Y axis unit back to dBm.

### NOTE

The units of current (A, dBmA, dBuA) are calculated based on 50 ohms input impedance.

All four of the EMI units (dBμA/m, dBμV/m, dBG, dBpT) are treated by the instrument exactly as though they were dBuV. The user must load an appropriate correction factor using Amplitude Corrections for accurate and meaningful results.

If a SCPI command is sent to the analyzer that uses one of the EMI units as a terminator, the analyzer treats it as though DBUV had been sent as the terminator.

Key Path	AMPTD Y Scale
Mode	SA
Scope	Meas Global
<b>Remote Command</b>	:UNIT:POWer DBM   DBMV   DBMA   V   W   A   DBUV   DBUA   DBPW   DBUVM   DBUAM   DBPT   DBG :UNIT:POWer?
<b>Example</b>	UNIT:POW dBmV UNIT:POW?
Notes	The Y axis unit has either logarithmic or linear characteristics. The set of units that is logarithmic consists of dBm, dBmV, dBmA, dBμV, dBμA, dBμV/m, dBμA/m, dBpT, and dBG. The set of units that are linear consists of V, W, and A. The chosen unit will determine how the reference level and all the amplitude-related outputs like trace data, marker data, etc. read out.

Notes	<p>The settings of Y Axis Unit and Scale Type, affect how the data is read over the remote interface. When using the remote interface no unit is returned, so you must know what the Y axis unit is to interpret the results:</p> <p>Example 1, set the following: Scale Type (Log) Y Axis Unit, dBm Scale/Div, 1 dB Ref Level, 10 dBm</p> <p>This sets the top line to 10 dBm with each vertical division representing 1 dB. Thus, if a point on trace 1 is on the fifth graticule line from the top, it represents 5 dBm and will read out remotely as 5.</p> <p>Example 2, set the following: Scale Type (Lin) Y Axis Unit, Volts Ref Level, 100 mV (10 mV/div)</p> <p>This sets the top line to 100 mV and the bottom line to 0 V, so each vertical division represents 10 mV. Thus, if a point on trace 1 is on the fifth graticule line from the top, it represents 50 mV and will read out remotely as 50.</p>
Dependencies	<p>If an amplitude correction with an Antenna Unit other than None is applied and enabled, then that antenna unit is forced and the key with that unit is the only Y Axis Unit available. All other Y Axis Unit keys are grayed out.</p> <p>If an amplitude correction with an Antenna Unit other than None is applied and enabled, and you then turn off that correction or set Apply Corrections to No, the Y Axis Unit that existed before the Antenna Unit was applied is restored.</p>
Couplings	The analyzer retains the entered Y Axis Unit separately for both Log and Lin amplitude scale types
Preset	dBm for log scale, V for linear. The true 'preset' value is dBm, since at preset the Y Scale type is set to logarithmic.
State Saved	Saved in instrument state
Readback line	1-of-N selection
Initial S/W Revision	Prior to A.02.00
Modified at S/W Revision	A.02.00, A.04.00, A.11.00

## dBm

Sets the amplitude unit for the selected amplitude scale (log/lin) to dBm.

Key Path	AMPTD Y Scale, Y Axis Unit
<b>Example</b>	UNIT:POW DBM
Dependencies	Grayed out if an Amplitude Correction with an Antenna Unit is ON.
Readback	dBm
Initial S/W Revision	Prior to A.02.00
Modified at S/W Revision	A.02.00

## dBmV

Sets the amplitude unit for the selected amplitude scale (log/lin) to dBmV.

Key Path	AMPTD Y Scale, Y Axis Unit
<b>Example</b>	UNIT:POW DBMV
Dependencies	Grayed out if an Amplitude Correction with an Antenna Unit is ON.
Readback	dBmV
Initial S/W Revision	Prior to A.02.00
Modified at S/W Revision	A.02.00

## dBmA

Sets the amplitude unit for the selected amplitude scale (log/lin) to dBmA.

Key Path	AMPTD Y Scale, Y Axis Unit
<b>Example</b>	UNIT:POW DBMA
Dependencies	Grayed out if an Amplitude Correction with an Antenna Unit is ON.
Readback	dBmA
Initial S/W Revision	Prior to A.02.00
Modified at S/W Revision	A.02.00

## W

Sets the amplitude unit for the selected amplitude scale (log/lin) to watt.

Key Path	AMPTD Y Scale, Y Axis Unit
<b>Example</b>	UNIT:POW W
Dependencies	Grayed out if an Amplitude Correction with an Antenna Unit is ON.
Readback	W
Initial S/W Revision	Prior to A.02.00
Modified at S/W Revision	A.02.00

## V

Sets the amplitude unit for the selected amplitude scale (log/lin) to volt.

Key Path	AMPTD Y Scale, Y Axis Unit
<b>Example</b>	UNIT:POW V
Dependencies	Grayed out if an Amplitude Correction with an Antenna Unit is ON.

---

Readback	V
Initial S/W Revision	Prior to A.02.00
Modified at S/W Revision	A.02.00

---

## A

Sets the amplitude unit for the selected amplitude scale (log/lin) to Ampere.

---

Key Path	AMPTD Y Scale, Y Axis Unit
<b>Example</b>	UNIT:POW A
Dependencies	Grayed out if an Amplitude Correction with an Antenna Unit is ON.
Readback	A
Initial S/W Revision	Prior to A.02.00
Modified at S/W Revision	A.02.00

---

## dB $\mu$ V

Sets the amplitude unit for the selected amplitude scale (log/lin) to dB $\mu$ V.

---

Key Path	AMPTD Y Scale, Y Axis Unit
<b>Example</b>	UNIT:POW DBUV
Dependencies	Grayed out if an Amplitude Correction with an Antenna Unit is ON.
Readback	dB $\mu$ V
Initial S/W Revision	Prior to A.02.00
Modified at S/W Revision	A.02.00

---

## dB $\mu$ A

Sets the amplitude unit for the selected amplitude scale (log/lin) to dB $\mu$ A.

### NOTE

The unit dB $\mu$ A can also appear as an Antenna Unit. This will be used by customers using current probes, because current probes are often supplied with conversion tables that provide the transducer factors. When dB $\mu$ A is used as an Antenna Unit the normal conversion from power to amps for dB $\mu$ A (based on the analyzer input impedance) is not done, but instead the conversion is based solely on the Correction that contains the transducer factors. This is what distinguishes dB $\mu$ A as a normal unit from dB $\mu$ A as an antenna unit. When querying the Y-Axis unit, you can query the Antenna Unit to distinguish between regular dB $\mu$ A and the dB $\mu$ A antenna unit. If :CORR:CSET:ANT? returns NOC (for No Conversion), you are using a normal Y Axis dB $\mu$ A. If it returns UA you are using an Antenna Unit dB $\mu$ A.

---

Key Path	AMPTD Y Scale, Y Axis Unit
<b>Example</b>	UNIT:POW DBUA
Dependencies	Grayed out if an Amplitude Correction with an Antenna Unit is ON.
Readback	dB $\mu$ A
Initial S/W Revision	Prior to A.02.00
Modified at S/W Revision	A.02.00

## dBpW

Sets the amplitude unit for the selected amplitude scale (log/lin) to dBpW.

Key Path	AMPTD Y Scale, Y Axis Unit
<b>Example</b>	UNIT:POW DBPW
Dependencies	Grayed out if an Amplitude Correction with an Antenna Unit is ON.
Readback	dB $\mu$ A
Initial S/W Revision	A.11.00

## Antenna Unit

When a Correction is turned on that uses an Antenna Unit, the Y Axis Unit changes to that Antenna Unit. All of the keys in the Y-Axis Unit menu are then greyed out, except the Antenna Unit key. The unit being used is shown on this key and is shown as selected in the submenu.

Key Path	AMPTD Y Scale, Y Axis Unit
Dependencies	Grayed out if no Amplitude Correction with an Antenna Unit is on.
Readback line	Currently selected unit
Initial S/W Revision	A.11.00

## dB $\mu$ V/m

Sets the amplitude unit for the selected amplitude scale (log/lin) to dB $\mu$ V/m. This is an antenna unit, and this key is grayed out unless a Correction with this Antenna Unit selected is ON. If this is the case, all of the other Antenna Units are grayed out.

Key Path	AMPTD Y Scale, Y Axis Unit, Antenna Unit
<b>Example</b>	UNIT:POW DBUVM
Dependencies	Grayed out if no Amplitude Correction with an Antenna Unit is on.
Readback	dB $\mu$ V/m
Initial S/W Revision	A.02.00

### dB $\mu$ A/m

Sets the amplitude unit for the selected amplitude scale (log/lin) to dB $\mu$ A/m. This is an antenna unit, and this key is grayed out unless a Correction with this Antenna Unit selected is ON. If this is the case, all of the other Antenna Units are grayed out.

Key Path	AMPTD Y Scale, Y Axis Unit, Antenna Unit
<b>Example</b>	UNIT:POW DBUAM
Dependencies	Grayed out if no Amplitude Correction with an Antenna Unit is on.
Readback	dB $\mu$ A/m
Initial S/W Revision	A.02.00

### dB $\mu$ A

Sets the amplitude unit for the selected amplitude scale (log/lin) to dB $\mu$ A. This is an antenna unit, and this key is grayed out unless a Correction with this Antenna Unit selected is ON. If this is the case, all of the other Antenna Units are grayed out.

Key Path	AMPTD Y Scale, Y Axis Unit, Antenna Unit
<b>Example</b>	UNIT:POW DBUAM
Dependencies	Grayed out if no Amplitude Correction with an Antenna Unit is on.
Readback	dB $\mu$ A
Initial S/W Revision	A.11.00

### dB $\rho$ T

Sets the amplitude unit for the selected amplitude scale (log/lin) to dB $\rho$ T. This is an antenna unit, and this key is grayed out unless a Correction with this Antenna Unit selected is ON. If this is the case, all of the other Antenna Units are grayed out.

Key Path	AMPTD Y Scale, Y Axis Unit, Antenna Unit
<b>Example</b>	UNIT:POW DBPT
Dependencies	Grayed out if no Amplitude Correction with an Antenna Unit is on.
Readback	dB $\rho$ T
Initial S/W Revision	A.02.00

### dBG

Sets the amplitude unit for the selected amplitude scale (log/lin) to dBG. This is an antenna unit, and this key is grayed out unless a Correction with this Antenna Unit selected is ON. If this is the case, all of the other Antenna Units are grayed out.

Key Path	AMPTD Y Scale, Y Axis Unit, Antenna Unit
<b>Example</b>	UNIT:POW DBG
Dependencies	Grayed out if no Amplitude Correction with an Antenna Unit is on.
Readback	dBG
Initial S/W Revision	A.02.00

### None

This is selected if no Antenna Unit is currently on, however you cannot actually set this value, since it is always grayed out. The key is included simply to provide an indication on the Readback line of the Antenna Unit key when there is no Antenna Unit selected.

Key Path	AMPTD Y Scale, Y Axis Unit, Antenna Unit
Readback	"None"
Initial S/W Revision	A.11.00

### Ref Level Offset

Adds an offset value to the displayed reference level. The reference level is the absolute amplitude represented by the top graticule line on the display.

Key Path	AMPTD Y Scale
<b>Remote Command</b>	:DISPlay:FSCan:VIEW[1]:WINDow[1]:TRACe:Y[:SCALE]:RLEVel:OFFSet <rel_ ampl>  :DISPlay:FSCan:VIEW[1]:WINDow[1]:TRACe:Y[:SCALE]:RLEVel:OFFSet?
<b>Example</b>	DISP:FSC:VIEW:WIND:TRAC:Y:RLEV:OFFS 12.7 Sets the Ref Level Offset to 12.7 dB. The only valid suffix is dB. If no suffix is sent, dB will be assumed. DISP:FSC:VIEW:WIND:TRAC:Y:RLEV:OFFS?
Preset	0 dB
State Saved	Saved in instrument state.
Min	The range for Ref Lvl Offset is variable. It is limited to values that keep the reference level within the range of -327.6 dB to 327.6 dB.
Max	327.6 dB
Default Unit	dB
Initial S/W Revision	A.07.00

### Internal Preamp

Accesses a menu of keys that control the internal preamps. Turning on the preamp gives a better noise figure, but a poorer TOI to noise floor dynamic range. You can optimize this setting for your particular

measurement.

The instrument takes the preamp gain into account as it sweeps. If you sweep outside of the range of the preamp the instrument will also account for that. The displayed result will always reflect the correct gain.

For some measurements, when the preamp is on and any part of the displayed frequency range is below the lowest frequency for which the preamp has specifications, a warning condition message appears in the status line. For example, for a preamp with a 9 kHz lowest specified frequency: "Preamp: Accy unspec'd below 9 kHz".

<b>Key Path</b>	AMPTD Y Scale
<b>Scope</b>	Meas Global
<b>Remote Command</b>	[ :SENSe ] :POWeR [ :RF ] :GAIN [ :STATe ] OFF   ON   0   1 [ :SENSe ] :POWeR [ :RF ] :GAIN [ :STATe ] ?
<b>Dependencies</b>	Preamp is not available on all hardware platforms. If the preamp is not present or is unlicensed, the key is not shown. The preamp is not available when the electronic/soft attenuator is enabled.
<b>Couplings</b>	The act of connecting the U7227A USB Preamplifier to one of the analyzer's USB ports will cause the Internal Preamp to be switched on. When this happens an informational message will be generated: "Internal Preamp turned on for optimal operation with USB Preamp." Note that if the Internal Preamp was already on, there will be no change to the setting, but if it was Off it will be switched On, to Full Range. Note that this same action occurs when the SA mode is selected while the USB Preamp is connected to one of the analyzer's USB ports, if it is the first time that the SA mode has run since powerup, or if the last time the SA mode was running the USB Preamp was NOT connected. Subsequently disconnecting the USB Preamp from USB does not change the Internal Preamp setting nor restore the previous setting.
<b>Preset</b>	OFF
<b>State Saved</b>	Saved in instrument state
<b>Initial S/W Revision</b>	Prior to A.02.00
<b>Modified at S/W Revision</b>	A.14.00

<b>Key Path</b>	AMPTD Y Scale, Internal Preamp
<b>Scope</b>	Meas Global
<b>Remote Command</b>	[ :SENSe ] :POWeR [ :RF ] :GAIN :BAND LOW   FULL [ :SENSe ] :POWeR [ :RF ] :GAIN :BAND ?
<b>Dependencies</b>	Preamp is not available on all hardware platforms. If the preamp is not present or is unlicensed, the key is not shown. If a POW:GAIN:BAND FULL command is sent when a low band preamp is available, the preamp band parameter is to LOW instead of FULL, and an "Option not installed" message is generated.
<b>Preset</b>	LOW
<b>State Saved</b>	Saved in instrument state
<b>Initial S/W Revision</b>	Prior to A.02.00



## Off

Turns the internal preamp off

Key Path	AMPTD Y Scale, Internal Preamp
<b>Example</b>	:POW:GAIN OFF
Readback	Off
Initial S/W Revision	Prior to A.02.00

## Low Band

Sets the internal preamp to use only the low band.

The frequency range of the installed (optional) low-band preamp is displayed in square brackets on the Low Band key label.

Key Path	AMPTD Y Scale, Internal Preamp
<b>Example</b>	:POW:GAIN ON :POW:GAIN:BAND LOW
Readback	Low Band
Initial S/W Revision	Prior to A.02.00

## Full Range

Sets the internal preamp to use its full range. The low band (0–3.6 GHz or 0–3GHz, depending on the model) is supplied by the low band preamp and the frequencies above low band are supplied by the high band preamp.

The frequency range of the installed (optional) preamp is displayed in square brackets on the Full Range key label. If the high band option is not installed the Full Range key does not appear.

Key Path	AMPTD Y Scale, Internal Preamp
<b>Example</b>	:POW:GAIN ON :POW:GAIN:BAND FULL
Readback	Full Range
Initial S/W Revision	Prior to A.02.00

## Backwards Compatibility SCPI Commands

"Internal Preamp State (Remote Command Only)" on page 394

"Grid Bottom Level (Remote Command Only)" on page 394

"Grid Top Level (Remote Command Only)" on page 395

### Internal Preamp State (Remote Command Only)

This SCPI command is used to set the Internal Preamp state of the meters display.

<b>Remote Command</b>	:INPut [1]   2 :GAIN [:STATe] ON OFF 1 0 :INPut [1]   2 :GAIN [:STATe] ?
<b>Example</b>	INP:GAIN ON INP:GAIN?
<b>Notes</b>	This command is included for ESU compatibility. The suffix [1]2 is irrelevant to the measurement, they are added solely for remote language compatibility. ON is aliased to POW:GAIN ON; :POW:GAIN:BAND LOW. OFF is aliased to POW:GAIN OFF.
<b>Preset</b>	OFF
<b>State Saved</b>	Saved in instrument state
<b>Initial S/W Revision</b>	A.07.00

### Grid Bottom Level (Remote Command Only)

This command defines the bottom grid level in the current unit for the scan display.

<b>Remote Command</b>	:DISPlay [:WINDow] :TRACe [1]   2   3 :Y [:SCALe] :BOTTom <real> :DISPlay [:WINDow] :TRACe [1]   2   3 :Y [:SCALe] :BOTTom?
<b>Example</b>	DISP:TRAC:Y:BOTT 5 DISP:TRAC:Y:BOTT?
<b>Notes</b>	This command is included for ESU compatibility. The suffix [1]2 and [1]2 3 are irrelevant to the measurement, they are added solely for remote language compatibility.
<b>Couplings</b>	When this value is changed, the reference level will be changed based on: Ref Level = Min Grid Level + 10* Scale/Div The value of bottom grid level will be recalculated based on the exact Ref Level value. Similar to Ref Level, the allowed range of the Grid Level setting is affected by the Ref Level Offset Value.
<b>Preset</b>	6.99 dBuV
<b>State Saved</b>	Saved in instrument state.
<b>Min</b>	-163.01 dBuV
<b>Max</b>	36.99 dBuV
<b>Backwards Compatibility SCPI</b>	:DISPlay :WINDow [1]   2 :TRACe [1]   2   3 :Y [:SCALe] :BOTTom
<b>Backwards Compatibility SCPI Notes</b>	The SCPI command is not stated in the ESU user manual, but it is used by the EMC32 application.
<b>Initial S/W Revision</b>	A.07.00

## Grid Top Level (Remote Command Only)

This command defines the top grid level in the current unit for the scan display. This command is different from Reference level where it will adjust the scale per division based on the value set for the bottom grid level.

<b>Remote Command</b>	:DISPlay[:WINDow]:TRACe[1] 2 3:Y[:SCALe]:TOP <real> :DISPlay[:WINDow]:TRACe[1] 2 3:Y[:SCALe]:TOP?
<b>Example</b>	DISP:TRAC:Y:TOP 5 DISP:TRAC:Y:TOP?
<b>Notes</b>	This command is included for ESU compatibility. It is not stated in the ESU user manual, but it is used by the EMC32 application. The suffix [1]2 3 are irrelevant to the measurement, they are added solely for remote language compatibility.
<b>Couplings</b>	When this value is changed, the reference level will be changed to the same value. The Scale per division will be changed based on: Scale/Div = ( Top Grid Level - Bottom Grid Level) / 10 The value of the bottom grid level will be recalculated based on the exact Scale/Div value. Similar to Ref Level, the allowed range of the Grid Level setting is affected by the Ref Level Offset Value.
<b>Preset</b>	106.99 dBuV
<b>State Saved</b>	Saved in instrument state.
<b>Min</b>	-63.01 dBuV
<b>Max</b>	136.99 dBuV
<b>Backwards Compatibility SCPI</b>	:DISPlay:WINDow[1] 2:TRACe[1] 2 3:Y[:SCALe]:TOP
<b>Backwards Compatibility SCPI Notes</b>	The SCPI command is not stated in the ESU user manual, but it is used by the EMC32 application.
<b>Initial S/W Revision</b>	A.07.00

## Auto Couple

The Auto Couple feature provides a quick and convenient way to automatically couple multiple instrument settings. This helps ensure accurate measurements and optimum dynamic range. When the Auto Couple feature is activated, either from the front panel or remotely, all parameters of the current measurement that have an Auto/Manual mode are set to Auto mode and all measurement settings dependent on (or coupled to) the Auto/Man parameters are automatically adjusted for optimal performance.

However, the Auto Couple key actions are confined to the current measurement only. It does not affect other measurements in the mode, and it does not affect markers, marker functions, or trace or display attributes.

See ["More Information" on page 396](#)

Key Path	Front-panel key
Remote Command	:COUPle ALL NONE
Example	:COUP ALL
Notes	:COUPle ALL puts all Auto/Man parameters in Auto mode (equivalent to pressing the Auto Couple key). :COUPLE NONE puts all Auto/Man parameters in manual mode. It decouples all the coupled instrument parameters and is not recommended for making measurements.
Initial S/W Revision	Prior to A.02.00

### More Information

There are two types of functions that have Auto/Manual modes.

#### Auto/Man Active Function keys

An Auto/Man toggle key controls the binary state associated with an instrument parameter by toggling between Auto (where the parameter is automatically coupled to the other parameters it is dependent upon) and Man (where the parameter is controlled independent of the other parameters), as well as making the parameter the active function. The current mode is indicated on the softkey with either Auto or Man underlined as illustrated below.



#### Auto/Man 1-of-N keys

An Auto/Man 1-of-N key allows you to manually pick from a list of parameter values, or place the function in Auto, in which case the value is automatically selected (and indicated) as shown below. If in Auto, Auto is underlined on the calling key. If in manual operation, manual is indicated on the calling key. But the calling key does not actually toggle the function, it simply opens the menu.

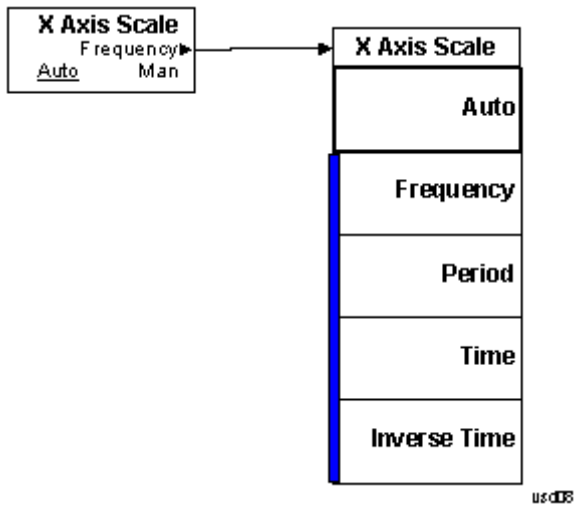

## BW

Displays the menu key that enables you to control the resolution BW.

Key Path	Front-panel key
Notes	Front panel only.
Initial S/W Revision	A.07.00

## Res BW

Activates the Resolution Bandwidth (RBW) action function, which allows you to manually set the RBW.

Key Path	BW								
<b>Remote Command</b>	<pre>[ :SENSe ] :BANDwidth BWIDth[:RESolution] &lt;freq&gt; [ :SENSe ] :BANDwidth BWIDth[:RESolution]? [ :SENSe ] :BANDwidth BWIDth[:RESolution]:AUTO OFF ON 0 1 [ :SENSe ] :BANDwidth BWIDth[:RESolution]:AUTO?</pre>								
<b>Example</b>	<pre>BAND 200kHz BAND? FSC:BAND:AUTO 0 FSC:BAND:AUTO?</pre>								
Notes	<p>For Frequency Scan measurements, this key only affects RBWs used for meters.</p> <p>For numeric entries, the RBW chooses the nearest (arithmetically, on a linear scale, rounding up) available RBW to the value entered.</p> <p>The suffix 1 2 is irrelevant to the measurement, they are added solely for remote language compatibility.</p>								
Dependencies	<p>When in zero span and EMC Std is set to None, there is no Auto setting for the Res BW. The Auto/Man line on the Res BW softkey disappears in this case, and if the SCPI command [ :SENSe ]:BWID[:RESolution]:AUTO ON is sent, it generates an error.</p>								
Couplings	<p>When a CISPR or MIL EMI Standard is in use, the Res BW is coupled to the Center Frequency and not to the Span.</p> <p>When in the CISPR or MIL EMC Standard, selecting Auto will make RBW auto coupled to Center Frequency, in order to comply with EMI specs.</p> <p>When EMC Standard= CISPR,</p> <table border="1" style="width: 100%; border-collapse: collapse;"> <tr> <td style="width: 60%;"><math>&lt;150\text{ kHz}</math></td> <td>200 Hz</td> </tr> <tr> <td><math>150\text{ kHz to } &lt;30\text{ MHz}</math></td> <td>9 kHz</td> </tr> <tr> <td><math>\geq 30\text{ MHz to } &lt;1\text{ GHz}</math></td> <td>120 kHz</td> </tr> <tr> <td><math>\geq 1\text{ GHz}</math></td> <td>1 MHz</td> </tr> </table> <p>When EMC Standard= MIL,</p>	$<150\text{ kHz}$	200 Hz	$150\text{ kHz to } <30\text{ MHz}$	9 kHz	$\geq 30\text{ MHz to } <1\text{ GHz}$	120 kHz	$\geq 1\text{ GHz}$	1 MHz
$<150\text{ kHz}$	200 Hz								
$150\text{ kHz to } <30\text{ MHz}$	9 kHz								
$\geq 30\text{ MHz to } <1\text{ GHz}$	120 kHz								
$\geq 1\text{ GHz}$	1 MHz								

	< 1 kHz	10 Hz
	1 kHz to < 10 kHz	100 Hz
	10 kHz to < 150 kHz	1 kHz
	150 kHz to <30 MHz	10 kHz
	30 MHz to <1 GHz	100 kHz
	≥1 GHz	1 MHz
Preset	120 kHz ON	
State Saved	Saved in instrument state	
Min	1 Hz	
Max	8 MHz is the max equivalent -3 dB RBW, which means that the named RBW (the one shown on the key ) can actually exceed 8 MHz if using a filter type other than -3dB.	
Default Unit	Hz	
<b>Backwards Compatibility SCPI</b>	:SENSe1 SENSe2  [SENSe]:BANDwidth BWIDth[:RESolution]	
Backwards Compatibility SCPI Notes	This command above is included for ESU compatibility. The suffix 1 2 is irrelevant to the measurement, they are added solely for remote language compatibility.	
Initial S/W Revision	A.07.00	

## Filter BW

Allows you to choose the filter based on its -3 dB (Normal) bandwidth, its -6 dB bandwidth, its Noise bandwidth, or its Impulse bandwidth.

Key Path	BW
<b>Remote Command</b>	[ :SENSe: ] :BANDwidth BWIDth[:RESolution]:TYPE DB3   DB6   IMPulse   NOISe  [ :SENSe: ] :BANDwidth BWIDth[:RESolution]:TYPE?
<b>Example</b>	BAND:TYPE DB6 BAND:TYPE?
Notes	When NOISe is sent, the Filter BW will only be changed when the EMC Standard is set to None. The Filter BW will be set to Noise when the IDN Model = System IDN Response. For other IDN Models, the Filter BW will be set to DB3. This is for ESU Backwards Compatibility.
Dependencies	DB3 DB6 IMPulse are not available when the EMC Standard is set to CISPR or MIL. See error - 221.1100 in Master Error Messages: X-Series document for exact error text.
Preset	Preset type is based on EMC Standard Preset To key.
State Saved	Saved in instrument state.
Range	DB3 DB6 IMPulse NOISe

Readback Text	The currently selected Filter BW
<b>Backwards Compatibility SCPI</b>	SENSe1   SENSe2   [SENSe] :BANDwidth BWIDth[:RESolution]
Backwards Compatibility SCPI Notes	This command above is included for ESU compatibility. The suffix 1 2 is irrelevant to the measurement; they are added solely for remote language compatibility.
Initial S/W Revision	A.10.00
<b>Remote Command</b>	:SENSe1 SENSe2 [SENSe]:BANDwidth BWIDth[:RESolution]:TYPE NORMal   PULSe  :SENSe1 SENSe2 [SENSe]:BANDwidth BWIDth[:RESolution]:TYPE?
<b>Example</b>	BAND:TYPE PULS BAND:TYPE?
Notes	This command is included for ESU compatibility. The suffix [1]2 is irrelevant to the measurement, they are added solely for the compatibility purpose. "NORMal" is alias to Filter BW "3dB" when the EMC Standard is set to None. Or else, sending this command will not change the Filter BW. "PULSe" is alias to Filter BW "6dB" when the EMC Standard is set to None. Or else, sending this command will not change the Filter BW.
Range	NORMal PULSe



## Cont

Sets the Frequency Scan for continuous operation. See "[Continuous/ Single Scan](#) " on page 573 for more information.

If you are already in continuous scan, pressing the Continuous key has no effect.

If scan sequence is in Scan only and no active scan is running, pressing the Continuous key starts a new scan.

Key Path	Front-panel key
Initial S/W Revision	A.07.00

8 Frequency Scan Measurement  
File

File

See "File" on page 266

## FREQ Channel

Displays the menu keys that enable you to control the frequency parameters and scale type.

Key Path	Front-panel key
Notes	Front panel only.
Initial S/W Revision	A.07.00

## Frequency

Sets the frequency of Meters in the Frequency Scan measurement. For the Strip Chart measurement, this key will set the frequency for both meters and strip chart. For APD measurement, this key is used to set the frequency to perform Amplitude Probability Distribution. For Monitor Spectrum measurement, this key is used to set the Center Frequency.

Key Path	FREQ Channel
<b>Remote Command</b>	<code>[ :SENSe ] :FREQuency:CENTer &lt;frequency&gt;</code> <code>[ :SENSe ] :FREQuency:CENTer ?</code>
<b>Example</b>	FREQ:CENT 3 GHZ FREQ:CENT?
Notes	For the Frequency Scan measurement, when QPD, EMI Average or RMS Average detectors is selected, you will see some delay for meters to reflect the new data due to filtering time. However, if the change in the meters frequency is performed by knob or step keys, there will be no filtering time added unless the change of the meters frequency has triggered other parameter changes.
Preset	515 MHz
State Saved	Saved in instrument state.
Min	For Frequency Scan and Strip Chart measurements, it depends on the instrument minimum frequency.
Max	For Frequency Scan, and Strip Chart measurements, it depends on the instrument maximum frequency.
Default Unit	Hz
Status Bits/OPC dependencies	non-overlapped
<b>Backwards Compatibility SCPI</b>	<code>:SENSe1   SENSe2   [SENSe] :FREQuency:CENTer</code> <code>:SENSe1   SENSe2   [SENSe] :FREQuency:FIXed</code>
Backwards Compatibility SCPI Notes	These commands above are included for ESU compatibility. The suffix 1 2 is irrelevant to the measurement, they are added solely for remote language compatibility.
Initial S/W Revision	A.07.00

## Midspan Frequency

Sets the frequency at midspan of the graticule display.

Key Path	FREQ Channel
Remote Command	[ :SENSe ] :FREQuency:MIDSpan <freq> [ :SENSe ] :FREQuency:MIDSpan?
Example	FREQ:MIDS 140 MHZ FREQ:MIDS?
Notes	The Max values are depending on Hardware Options (503, 507, 508, 513, 526)
Dependencies	TheFrequency can be limited by Start or Stop Freq limits, if the Span is so large that Start or Stop reaches their limit.
Preset	515 MHz
State Saved	Saved in instrument state.
Min	Depends on the instrument minimum frequency and 10 Hz minimum span. If the knob or step keys are being used, it depends on the value of the other three interdependent parameters.
Max	Depends on the instrument maximum frequency - 10 Hz minimum span. If the knob or step keys are being used, it depends on the value of the stop frequency
Default Unit	Hz
Status Bits/OPC dependencies	non-overlapped
Initial S/W Revision	A.08.00

## Start Frequency

Sets the frequency at the left side of the graticule display.

Key Path	FREQ Channel
Remote Command	[ :SENSe ] :FREQuency:STARt <frequency> [ :SENSe ] :FREQuency:STARt? [ :SENSe ] :FREQuency:STARt:AUTO ON OFF 1 0 [ :SENSe ] :FREQuency:STARt:AUTO?
Example	FREQ:STAR 3 GHZ FREQ:STAR? FREQ:STAR:AUTO 1 FREQ:STAR:AUTO?
Notes	Max values are dependent on Hardware Options (503, 507, 508, 513, 526)
Dependencies	By direct entry: You cannot set the Start frequency > the Stop frequency. You cannot set the Start frequency = the Stop frequency. You cannot select zero span by setting Start = Stop. You cannot set the Start Frequency to a value that would create a span of less than 10 Hz. If you try to do any of these, the Stop Frequency will change to maintain a minimum value of 10 Hz for the difference between Start

	<p>and Stop.</p> <p>With the knob or step keys:</p> <p>Cannot increment the Start Freq to a value greater than the Stop Freq – 10 Hz. If already in zero span, you cannot increment at all, and the first decrement will be forced to at least 10 Hz.</p> <p>The Start Frequency can be limited by Span limits, if the Stop Frequency is below its preset value.</p> <p>This key is grayed out when a scan sequence is running. If the grayed out key is pressed, an advisory message is generated. If the equivalent SCPI command is sent, this same message is generated as part of a “-221, Settings conflict” warning.</p>
Couplings	<p>None</p> <p>In auto, the start frequency value will couple to the start frequency of the lowest turned-on range in the scan table. If all ranges are off, the start frequency will be set to 30 MHz.</p>
Preset	<p>30 MHz</p> <p>ON</p>
State Saved	<p>Saved in instrument state.</p>
Min	<p>If the knob or step keys are being used, it depends on the value of the stop frequency</p> <p>When the Scale Type is set to Log, the min Start Frequency will be limited to 10 Hz. If you set the Start Frequency to a value &lt;10 Hz during Lin Scale Type, changing the Scale Type to Log will automatically change the start frequency to 10Hz. However, changing the Scale Type back to Lin type will not change the frequency to the value previously set.</p>
Max	<p>Depends on the instrument maximum frequency – 10 Hz minimum span. If the knob or step keys are being used, it depends on the value of the stop frequency</p>
Default Unit	<p>Hz</p>
Status Bits/OPC dependencies	<p>non-overlapped</p>
<b>Backwards Compatibility SCPI</b>	<p>:SENSE1   SENSE2 :FREQUENCY:START</p>
Backwards Compatibility SCPI Notes	<p>This command above is included for ESU compatibility. The suffix 1 2 is irrelevant to the measurement, they are added solely for remote language compatibility.</p>
Initial S/W Revision	<p>A.07.00</p>

## Stop Frequency

Sets the frequency at the right side of the graticule display.

Key Path	<p>FREQ Channel</p>
Remote Command	<p>[ :SENSE ] :FREQUENCY:STOP &lt;frequency&gt;</p> <p>[ :SENSE ] :FREQUENCY:STOP?</p> <p>[ :SENSE ] :FREQUENCY:STOP:AUTO ON OFF 1 0 0 1</p> <p>[ :SENSE ] :FREQUENCY:STOP:AUTO?</p>
Example	<p>FREQ:STOP 10 GHZ</p> <p>FREQ:STOP?</p>

	FREQ:STOP:AUTO 1 FREQ:STOP:AUTO?
Notes	The Max values are dependent on Hardware Options (503, 507, 508, 513, 526)
Dependencies	<p>By direct entry:</p> <p>You cannot set the Stop frequency &lt; the Start frequency. You cannot set the Start frequency = the Stop frequency. You cannot select zero span by setting Start = Stop. You cannot set the Stop Frequency to a value that would create a span of less than 10 Hz. If you try to do any of these, the Start Frequency will change to maintain a minimum value of 10 Hz for the difference between Start and Stop.</p> <p>With the knob or step keys:</p> <p>You cannot decrement the Stop Freq to a value less than the Start Freq + 10 Hz. If already in zero span, you cannot decrement at all, and the first increment will be forced to at least 10 Hz.</p> <p>The Stop Frequency can be limited by Span limits, if the Start Frequency is above its preset value.</p> <p>This key is grayed out when a scan sequence is running. If the grayed out key is pressed, an advisory message is generated. If the equivalent SCPI command is sent, this same message is generated as part of a “-221, Settings conflict” warning.</p>
Couplings	<p>None</p> <p>In auto, the stop frequency value will couple to the stop frequency of the highest turned-on range in the scan table. If all ranges are off, the stop frequency will be set to 1 GHz.</p>
Preset	1 GHz ON
State Saved	Saved in instrument state.
Min	<p>If the knob or step keys are being used, it depends on the value of the start frequency</p> <p>When the Scale Type is set to Log, the min Stop Frequency will be limited to 20 Hz. If you set the Stop Frequency to a value &lt;20 Hz during Lin Scale Type, changing the Scale Type to Log will automatically change the start frequency to 20 Hz. However, changing the Scale Type back to Lin type will not change the frequency to the value previously set.</p>
Max	Depends on the instrument maximum frequency. If the knob or step keys are being used, it depends on the value of the start frequency
Default Unit	Hz
Status Bits/OPC dependencies	non-overlapped
<b>Backwards Compatibility SCPI</b>	:SENSe1   SENSe2 :FREQuency:STOP
Backwards Compatibility SCPI Notes	This command above is included for ESU compatibility. The suffix 1 2 is irrelevant to the measurement, they are added solely for remote language compatibility.
Initial S/W Revision	A.07.00

### Freq/ Step

Changes the step size for the Frequency.

Key Path	FREQ Channel
Remote Command	[ :SENSe ] :FREQuency:CENTer:STEP [ :INCRement ] <freq> [ :SENSe ] :FREQuency:CENTer:STEP [ :INCRement ] ? [ :SENSe ] :FREQuency:CENTer:STEP:AUTO OFF   ON   0   1 [ :SENSe ] :FREQuency:CENTer:STEP:AUTO?
Example	FREQ:CENT:STEP:AUTO ON FREQ:CENT:STEP 500 MHz FREQ:CENT UP increases the current center frequency value by 500 MHz FREQ:CENT:STEP? FREQ:CENT:STEP:AUTO?
Notes	Preset and Max values are dependent on Hardware Options (503, 508, 513, 526)
Preset	Auto ON
State Saved	Saved in instrument state
Min	- ( the maximum frequency of the instrument). (that is, a 27 GHz max freq instrument has a CF step range of +/- 27 GHz)
Max	The maximum frequency of the instrument. (that is, a 27 GHz max freq instrument has a CF step range of +/- 27 GHz)
Default Unit	Hz
Status Bits/OPC dependencies	non-overlapped
Initial S/W Revision	A.07.00

## Scale Type

Chooses a linear or logarithmic scaling for the frequency axis.

The scaling can be changed at any time and will determine only how the data will be displayed. It will have no impact on the sweep or trace data. Changing the scaling does not restart the sweep and has no impact on the number of sweep points. The scaling can be changed while traces are in View and they will scale appropriately. Markers will stay at their set frequency, so they will move on the display.

Note that trace data saved while the display is in log will look identical to trace data saved while the display is in linear. When recalling trace data, the current value of log or linear scaling will be used to display the data. (Trace +State files will recall with whatever log or linear setting was in effect when they were saved).

Key Path	FREQ Channel
Remote Command	:DISPlay:VIEW[1]:WINDow[1]:TRACe:X:SPACing LINear   LOGarithmic :DISPlay:VIEW[1]:WINDow[1]::TRACe:X:SPACing?
Example	DISP:VIEW:WIND:TRAC:X:SPAC LIN DISP:VIEW:WIND:TRAC:X:SPAC?

Preset	LOGarithmic
State Saved	Saved in instrument state.
Range	Log   Lin
<b>Backwards Compatibility SCPI</b>	:DISPlay:WINDow[1] 2:TRACe[1] 2 3:X:SPACing
	:DISPlay[:WINDow]:TRACe[1] 2 3:X:SPACing
Backwards Compatibility SCPI Notes	These commands above are included for ESU compatibility. The suffix [1]2 and [1]2 3 are irrelevant to the measurement, they are added solely for remote language compatibility.
Initial S/W Revision	A.07.00



## Input/Output

See "Input/Output" on page 150

## Marker

Accesses the Marker menu. The functions in this menu include a 1-of-N selection of the control mode Normal, Delta or Off for the selected marker. If the selected marker is Off, pressing Marker sets it to Normal and places it at the center of the screen on the trace determined by the Marker Trace rules. Markers may also be used in pairs to read the difference (or delta) between two data points.

The SCPI command in the table below selects the marker and sets the marker control mode as described under Normal, Delta, Fixed and Off. All interactions and dependencies detailed under the key description are enforced when the remote command is sent.

<b>Key Path</b>	Front-panel key
<b>Remote Command</b>	:CALCulate:FSCan:MARKer[1] 2 ... 12:MODE POSition DELTA OFF :CALCulate:FSCan:MARKer[1] 2 ... 12:MODE?
<b>Example</b>	CALC:FSC:MARK:MODE2 OFF Turn off Marker 2. CALC:FSC:MARK:MODE2?
<b>Notes</b>	The marker X axis value entered in the active function area will display the marker value to its full entered precision.
<b>Preset</b>	OFF
<b>State Saved</b>	Saved in instrument state.
<b>Range</b>	Normal Delta Off
<b>Initial S/W Revision</b>	A.07.00

## Select Marker

Specifies the selected marker. The term “Selected marker” is used throughout this document to specify which marker will be affected by the functions.

<b>Key Path</b>	Marker
<b>Notes</b>	Front panel only. The selected marker is remembered even when not in the Marker menu and is used if a Search is done or a Marker Function is turned on.
<b>Preset</b>	Marker 1
<b>State Saved</b>	Saved in instrument state.
<b>Initial S/W Revision</b>	A.07.00

## Normal

Sets the control mode for the selected marker to Normal and turns on the active function for setting its value. If the selected marker was on, it is placed at the center of the screen on the trace specified by the marker’s Trace attribute. But if there is a signal in the signal list, the marker will turn on at the current signal.

A Normal mode (POSition type) marker can be moved to any point on the X Axis by specifying its X Axis value. Its absolute Y Axis value is then the value of the trace point at that X Axis value.

Key Path	Marker
<b>Example</b>	CALC:FSC:MARK:MODE POS Sets Marker 1 to Normal.
Couplings	The marker addressed by this command becomes the selected marker on the front panel.
State Saved	Saved in instrument state.
Initial S/W Revision	A.07.00

## Delta

Sets the control mode for the selected marker to Delta and turns on the active function for setting its delta value. If the selected marker is on, the marker is placed at the center of the screen on the trace specified by the marker's Trace attribute.

In Delta mode the marker result shows the relative result between the selected (Delta) marker and its reference marker. A delta marker can be moved to any point on the X Axis by specifying its X Axis offset from a reference marker. Its absolute Y Axis value is then the value of the trace point at that X Axis value.

Key Path	Marker
<b>Example</b>	CALC:FSC:MARK:MODE DELT Sets marker 1 to Delta.
Dependencies	The marker addressed by this command becomes the selected marker on the front panel.
State Saved	Saved in instrument state.
Initial S/W Revision	A.07.00

## Off

Turns off the selected marker. Removes the marker annunciation from the display. Turns off any active function. Turning the marker off does not affect which marker is selected.

Key Path	Marker
<b>Example</b>	CALC:FSC:MARK:MODE OFF Sets Marker 1 to Off.
State Saved	Saved in instrument state.
Initial S/W Revision	A.07.00

## Properties

Accesses a menu that enables you to set marker properties and to access the marker trace menu.

Key Path	Marker
Initial S/W Revision	A.07.00

## Select Marker

Specifies the selected marker. The term “Selected marker” is used throughout this document to specify which marker will be affected by the functions.

Key Path	Marker, Properties
Notes	Front panel only. The selected marker is remembered even when not in the Marker menu and is used if a Search is done or a Marker Function is turned on.
Preset	Marker 1
State Saved	Saved in instrument state.
Initial S/W Revision	A.07.00

## Relative To

Selects the reference marker for a marker in Delta mode.

Key Path	Marker, Properties
<b>Remote Command</b>	:CALCulate:FSCan:MARKer[1] 2 ... 12:REference <integer> :CALCulate:FSCan:MARKer[1] 2 ... 12:REference?
<b>Example</b>	CALC:FSC:MARK3:REF 1 Sets marker 3's reference marker to 1 and turns marker 3 on as a delta marker. CALC:FSC:MARK3:REF?
Notes	A marker cannot be relative to itself so that choice is grayed out, and if sent from SCPI, generates error -221: "Settings conflict; marker cannot be relative to itself." When queried, a single value will be returned - the specified marker number's relative marker.
Couplings	The act of specifying the selected marker's reference marker makes the selected marker a Delta marker. If the reference marker is off it is turned on in Normal mode at the delta marker location
Preset	By default, marker X is relative to marker X+1 except for marker 12, which is relative to marker 1.
State Saved	Saved in instrument state. Not affected by Marker Off and not affected by Preset or power cycle.
Range	1 2 3 4 5 6 7 8 9 10 11 12
Initial S/W Revision	A.07.00

## Marker Trace

Selects the trace that you want your marker to be placed on. A marker is associated with one and only one trace. This trace is used to determine the placement, result, and X Axis Scale of the marker. All markers have an associated trace, it is from that trace that they determine their attributes and behaviors, and it is to that trace that they go when they become Normal or Delta markers.

Key Path	Marker, Properties
<b>Remote Command</b>	:CALCulate:FSCan:MARKer[1] 2 ... 12:TRACe 1 2 3 :CALCulate:FSCan:MARKer[1] 2 ... 12:TRACe?

<b>Example</b>	CALC:FSC:MARK:TRAC 1 CALC:FSC:MARK:TRAC?
Notes	A marker may be placed on a blanked and/or inactive trace, even though the trace is not visible and/or updating.
Couplings	Sending the remote command causes the addressed marker to become selected.
Preset	1
State Saved	Saved in instrument state.
Range	1 2 3
Readback Text	Trace N where N is the trace number to which the marker is currently assigned.
Initial S/W Revision	A.07.00

## Couple Markers

When this function is on, moving any marker causes an equal X Axis movement of every other marker that is not off. By “equal X Axis movement” we mean that we preserve the difference between each marker’s X Axis value (in the fundamental x-axis units of the trace that marker is on) and the X Axis value of the marker being moved (in the same fundamental x-axis units).

This may result in markers going off screen.

Key Path	Marker
<b>Remote Command</b>	:CALCulate:FSCan:MARKer:COUple[:STATE] OFF ON 0 1 :CALCulate:FSCan:MARKer:COUple[:STATE]?
<b>Example</b>	CALC:FSC:MARK:COUP ON Sets Couple Markers on.
Preset	Off, presets on Mode Preset and All Markers Off
State Saved	Saved in instrument state.
Initial S/W Revision	A.07.00

## All Markers Off

Turn all markers off.

Key Path	Marker
<b>Remote Command</b>	:CALCulate:FSCan:MARKer:AOff
<b>Example</b>	CALC:FSC:MARK:AOff
Initial S/W Revision	A.07.00

### Marker X Axis Value (Remote Command Only)

The command below sets the marker X Axis value in the current marker X Axis Scale unit. In each case the marker that is addressed becomes the selected marker. It has no effect (other than to cause the marker to become selected) if the control mode is Off, but it is the SCPI equivalent of entering an X value if the control mode is Normal or Delta. The command input and query are both in relative values when delta marker is on.

<b>Remote Command</b>	:CALCulate:FSCan:MARKer[1] 2 ... 12:X <real> :CALCulate:FSCan:MARKer[1] 2 ... 12:X?
<b>Example</b>	CALC:FSC:MARK3:X 9e3 CALC:FSC:MARK3:X?
<b>Notes</b>	If no suffix is sent, it will use the fundamental units for the current marker X Axis Scale. If a suffix is sent that does not match the current marker X Axis Scale unit, an "Invalid suffix" error will be generated. The query returns the marker's absolute X Axis value if the control mode is Normal, or the offset from the marker's reference marker, if the control mode is Delta. The query is returned in the fundamental units for the current marker X Axis scale: seconds. If the marker is off the response is not a number (NAN).
<b>Couplings</b>	The Max value is changed by the Dwell Time parameter value.
<b>Preset</b>	After a preset, all Markers are turned off, so a Marker X Axis Value query will return not a number (NaN). When a Marker is on, the default value of the Marker X value is the center of the appropriate window.
<b>State Saved</b>	No
<b>Min</b>	-9.9E+37
<b>Max</b>	9.9E+37
<b>Initial S/W Revision</b>	A.07.00

### Marker Y Axis Value (Remote Command Only)

Returns the marker Y Axis value in the current marker Y Axis unit. The query is a relative value when the delta marker is on.

<b>Remote Command</b>	:CALCulate:FSCan:MARKer[1] 2 ... 12:Y?
<b>Example</b>	CALC:FSC:MARK11:Y? Query marker 11 value.
<b>Notes</b>	The query returns the marker Y-axis result. If the marker is Off the response is not a number (NAN).
<b>Preset</b>	Trace value at center of screen. There is no way to predict what this will be after a preset.
<b>State Saved</b>	No
<b>Initial S/W Revision</b>	A.07.00

### Backwards Compatibility SCPI Commands

"Normal Marker State (Remote Command Only)" on page 415

"Normal Marker X Axis Value (Remote Command Only)" on page 415

"Normal Marker Y Axis Value (Remote Command Only)" on page 415

"Delta Marker State (Remote Command Only)" on page 416

"Delta Marker X Axis Value (Remote Command Only)" on page 416

"Delta Marker Y Axis Value (Remote Command Only)" on page 416

### Normal Marker State (Remote Command Only)

Toggles the Normal marker state on and off.

<b>Remote Command</b>	:CALCulate[1] 2:MARKer[1] 2 ... 4[:STATe] ON OFF 1 0 :CALCulate[1] 2:MARKer[1] 2 ... 4[:STATe]?
<b>Example</b>	CALC:MARK4 ON Turn on maker 4 in Normal mode.
<b>Notes</b>	This SCPI is Meas Local and Context Sensitive. This SCPI alias to :CALC:FSC:MARK[1]2 3 4:MODE POS.
<b>Preset</b>	OFF
<b>Initial S/W Revision</b>	A.07.00

### Normal Marker X Axis Value (Remote Command Only)

Sets the selected marker to Normal mode, and sets/ gets the marker X Axis values.

<b>Remote Command</b>	:CALCulate[1] 2:MARKer[1] 2 ... 4:X <value> :CALCulate[1] 2:MARKer[1] 2 ... 4:X?
<b>Example</b>	CALC:MARK3:X 3e4 Turn on maker 3 in Normal mode, set the marker frequency to 30 kHz. CALC:MARK3:X? Turn on maker 3 in Normal mode and query the X axis value.
<b>Notes</b>	This SCPI is Meas Local and Context Sensitive. This SCPI alias to :CALC:FSC:MARK[1]2 3 4:MODE POS; :CALC:FSC:MARK[1]2 3 4:X?
<b>Preset</b>	9.91E+37
<b>Initial S/W Revision</b>	A.07.00

### Normal Marker Y Axis Value (Remote Command Only)

Sets the selected marker to Normal mode, and returns the marker Y Axis values.

<b>Remote Command</b>	:CALCulate[1] 2:MARKer[1] 2 ... 4:Y?
<b>Example</b>	CALC:MARK3:Y? Turn on maker 3 in Normal mode and query the Y axis value.
<b>Notes</b>	This SCPI is Meas Local and Context Sensitive. This SCPI alias to :CALC:FSC:MARK[1]2 3 4:MODE POS; :CALC:FSC:MARK[1]2 3 4:Y?
<b>Initial S/W Revision</b>	A.07.00

### Delta Marker State (Remote Command Only)

Toggles the Delta marker state on and off.

<b>Remote Command</b>	:CALCulate[1] 2:DELTamarker[1] 2 ... 4[:STATE] ON OFF 1 0 :CALCulate[1] 2:DELTamarker[1] 2 ... 4[:STATE]?
<b>Example</b>	CALC:DELT3 ON Turn on maker 3 in Delta mode.
<b>Notes</b>	This SCPI is Meas Local and Context Sensitive. This SCPI alias to :CALC:FSC:MARK[1]]2 3 4:MODE DELT.
<b>Preset</b>	OFF
<b>Initial S/W Revision</b>	A.07.00

### Delta Marker X Axis Value (Remote Command Only)

Sets the selected marker to Delta mode, and sets/ gets the marker X Axis values. The command input is in relative values and refers to the reference marker while the query always returns absolute values in order to make it compatible with the ESU.

<b>Remote Command</b>	:CALCulate[1] 2:DELTamarker[1] 2 ... 4:X <value> :CALCulate[1] 2:DELTamarker[1] 2 ... 4:X?
<b>Example</b>	CALC:DELT3:X 3e4 Turn on maker 3 in Delta mode, set the relative delta marker frequency to 30 kHz. CALC:DELT3:X? Turn on maker 3 in Delta mode and query the absolutes X axis value.
<b>Notes</b>	This SCPI is Meas Local and Context Sensitive. This SCPI alias to :CALC:FSC:MARK[1]]2 3 4:MODE DELT; followed by query of absolutes X Axis unit. The query is different from :CALC:FSC:MARK[1]]2 3 4:X? that returns the relative X Axis unit when marker in Delta mode.
<b>Preset</b>	0
<b>Initial S/W Revision</b>	A.07.00

### Delta Marker Y Axis Value (Remote Command Only)

Sets the selected marker to Delta mode, and returns the marker Y Axis values. The output is always a relative value referenced to a reference marker.

<b>Remote Command</b>	:CALCulate[1] 2:DELTamarker[1] 2 ... 4:Y?
<b>Example</b>	CALC:DELT3:Y? Turn on maker 3 in Normal mode and query the Y axis relative value.
<b>Notes</b>	This SCPI is Meas Local and Context Sensitive. This SCPI alias to :CALC:FSC:MARK[1]]2 3 4:MODE DELT;:CALC:FSC:MARK[1]]2 3 4:Y?
<b>Initial S/W Revision</b>	A.07.00



## Marker Function

Displays the menu keys that enable you to do marker related functions.

Key Path	Front-panel key
Notes	Front panel only.
Initial S/W Revision	A.07.00

### Select Marker

Specifies the selected marker. The term “Selected marker” is used throughout this document to specify which marker will be affected by the functions.

Key Path	Marker Function
Notes	Front panel only. The selected marker is remembered even when not in the Marker menu and is used if a Search is done or a Marker Function is turned on.
Preset	Marker 1
State Saved	Saved in instrument state.
Initial S/W Revision	A.07.00

### Measure at Marker

When the Measure At Marker key is pressed, the measurement will go to the frequency of the selected marker and take a reading with each of the three detectors selected in the Detectors menu, using the dwell times specified there, and then displays the readings in a window on the display, using the current Y axis unit.

If more than one trace is turned on, you can put a marker on any of the traces in the scan display and do a measure at marker.

Key Path	Marker Function
<b>Remote Command</b>	:CALCulate:FSCan:MARKer[1] 2 ... 12:FUNCtion:MAMarker?
<b>Example</b>	CALC:FSC:MARK3:FUNC:MAM? Performs a Measure at Marker function at Marker 3's current frequency and, when completed, returns the results of the measure at marker window in a query.
Notes	This query command returns comma separated values for the 3 specified detectors and the frequency value of the marker. The detector value is in the selected amplitude unit. If a Detector is off or if no measurement has yet completed, -999.0 dBm will be returned. The size of the return data array is fixed at 4. The elements are: 1. Detector 1 value ( if off, -999.0 dBm for backwards compatibility) 2. Detector 2 value ( if off, -999.0 dBm for backwards compatibility) 3. Detector 3 value ( if off, -999.0 for backwards compatibility) 4. Frequency of Marker

Dependencies	This key is grayed out when a scan sequence is running. If the grayed out key is pressed, an advisory message is generated. If the equivalent SCPI command is sent, this same message is generated as part of a “-221, Settings conflict” warning.
Couplings	If the specified Marker is not on, the analyzer turns it on at the center of the screen and does a peak search before performing the function.
Initial S/W Revision	A.07.00

## Measure at Marker Window

Pressing this key accesses a menu of keys that enable you to select the state and position of the Measure At Marker window.

Key Path	Marker Function
Readback	In square brackets, the state of the window then the window position, separated by commas, as [On, UpperLeft]
Initial S/W Revision	A.07.00

## Window On/Off

Turns the Measure at Marker window on and off. It turns on automatically when a Measure at Marker is initiated and turns off on a Preset. If the Window is turned on without a Measure at Marker result, --- is displayed for each result for which the detector is not “Off”.

Key Path	Marker Function, Meas at Mkr Window
Remote Command	:DISPlay:FSCan:WINDow:MAMarker[:STATe] ON OFF 1 0 :DISPlay:FSCan:WINDow:MAMarker[:STATe]?
Example	DISP:FSC:WIND:MAM 0 DISP:FSC:WIND:MAM?
Couplings	The window turns on automatically when a Measure at Marker is initiated and turns off on a Preset.
Preset	OFF
State Saved	Saved in instrument state
Range	On Off
Readback Text	On Off
Initial S/W Revision	A.07.00

## Window Position

Enables you to control the placement of the Measure at Marker window on the display.

Key Path	Marker Function, Meas at Mkr Window
----------	-------------------------------------

<b>Remote Command</b>	:DISPlay:FSCan:WINDow:MAMarker:POSition ULEFt   LLEFt   URIGht   LRIGht :DISPlay:FSCan:WINDow:MAMarker:POSition?
<b>Example</b>	DISP:FSC:WIND:MAM:POS LRIG DISP:FSC:WIND:MAM:POS?
<b>Notes</b>	ULEFt= Upper Left LLEFt= Lower Left URIGht= Upper Right LRIGht= Lower Right
<b>Preset</b>	ULEFt
<b>State Saved</b>	Saved in instrument state.
<b>Range</b>	Upper Left  Lower Left  Upper Right Lower Right
<b>Readback Text</b>	UpperLeft LowerLeft UpperRight LowerRight
<b>Initial S/W Revision</b>	A.07.00

## Detectors (Measure)

This key opens a menu that allows you to configure the detectors to be used for the Final Measurement and Measure at Marker reading. The same menu can be accessed from the Detectors key under the Marker Function menu. Any of the instrument's detectors can be used for each of the three detectors, or any of the three can be turned off. The dwell time for each detector is also settable.

When performing a Final Measurement or Measure at Marker, the dwell time settings that you select will depend on the characteristics of the emission you are measuring. The default dwell time (200 ms) should work well for typical EUT emissions, but sometimes you will encounter emissions for which the defaults are not optimal. This is especially the case for emissions that vary slowly over time or have a slow repetition rate. By lengthening the dwell times you can increase the likelihood of accurately measuring these low repetition rate signals.

When a Final Measurement or Measure at Marker is activated, the receiver makes a zero span measurement for each of the (up to) three detectors selected, using the Dwell Time set for each detector. If the signal's repetition period is greater than 200 ms (the default setting), the dwell time should be increased to capture at least two and preferably more repetitions of the signal. Additionally, if you do not need or do not wish to use a detector to make a measurement, that specific detector may be turned off.

Key Path	Meas Setup
Initial S/W Revision	A.07.00

## Select Detector

Specifies the selected detector. The "selected detector" is the detector that other parameters under the Final Measurement and Measure at Marker Detector menu will apply to.

Key Path	Meas Setup, Detectors (Measure)
Notes	Front panel only. The selected final detector is remembered even when not in the Detector Menu.
Preset	Detector 1, not affected by Mode Preset, preset by Restore Mode Defaults.
State Saved	Saved in instrument state.
Initial S/W Revision	A.07.00

## Dwell Time

Sets the dwell time for detectors

Key Path	Meas Setup, Detectors (Measure)												
<b>Remote Command</b>	<code>[ :SENSe ] :FSCan :FINal :DETEctor [ 1 ]   2   3 :DWELl &lt;dwell Time&gt;</code> <code>[ :SENSe ] :FSCan :FINal :DETEctor [ 1 ]   2   3 :DWELl ?</code>												
<b>Example</b>	FSC:FIN:DET3:DWEL 300ms Set dwell time of detector 3 to 300 ms. FSC:FIN:DET3:DWEL?												
Notes	Not affected by a Mode Preset, preset by a Restore Mode Defaults. The minimum Dwell Time is coupled to the detector type:- a) When the Quasi Peak detector is selected, the minimum Dwell Time is 0.5 ms. b) When the EMI Average/ RMS Average detector is selected, the minimum Dwell Time is 0.1 ms. c) When the Peak/ Negative Peak detector is selected, the minimum Dwell Time is depends on the smallest RBW among ranges turned on in the Scan Table.												
	<table border="1"> <tr> <td>RBW ≤ 10 Hz</td> <td>10 ms</td> </tr> <tr> <td>10 Hz &lt; RBW &lt; 100 Hz</td> <td>1 ms</td> </tr> <tr> <td>100 Hz &lt; RBW &lt; 200 Hz</td> <td>1 ms</td> </tr> <tr> <td>200 Hz &lt; RBW &lt; 1 kHz</td> <td>0.1 ms</td> </tr> <tr> <td>1 kHz &lt; RBW &lt; 100 kHz</td> <td>0.1 ms</td> </tr> <tr> <td>≥ 100 kHz</td> <td>50 us</td> </tr> </table>	RBW ≤ 10 Hz	10 ms	10 Hz < RBW < 100 Hz	1 ms	100 Hz < RBW < 200 Hz	1 ms	200 Hz < RBW < 1 kHz	0.1 ms	1 kHz < RBW < 100 kHz	0.1 ms	≥ 100 kHz	50 us
RBW ≤ 10 Hz	10 ms												
10 Hz < RBW < 100 Hz	1 ms												
100 Hz < RBW < 200 Hz	1 ms												
200 Hz < RBW < 1 kHz	0.1 ms												
1 kHz < RBW < 100 kHz	0.1 ms												
≥ 100 kHz	50 us												
Dependencies	This key is grayed out during final measurement. If the grayed out key is pressed, an advisory message is generated. If the equivalent SCPI command is sent, this same message is generated as part of a “-221, Settings conflict” warning.												
Couplings	If “Off” is selected for detector 1, this key is grayed out and shows 200 ms.												
Preset	200 ms 1 s 1 s												
State Saved	Saved in instrument state.												
Min	1 ms 1 s 1 s												
Max	60 s												
Default Unit	s												
Initial S/W Revision	A.07.00												

## Detector

Specifies the selected detector to be used for the Final Measurement and Measure at Marker, or to turn the selected Detector off. If you use the front panel to change the detector type, the following message will appear to remind you that the change of the detector will cause the data of the particular detector type column to be discarded.

Changing detector type will discard the detector values in the signal list, are you sure you want to do this?

Please press ENTER or OK to proceed. Press ESC or Cancel to close this dialog.

Key Path	Meas Setup, Detectors (Measure)
<b>Remote Command</b>	<code>[ :SENSe ] :FSCan:FINal:DETEctor[1]   2   3 POSitive   QPEak   EAverage   RAverage   AVERage   NEGative   OFF</code> <code>[ :SENSe ] :FSCan:FINal:DETEctor[1]   2   3 ?</code>
<b>Example</b>	FSC:FIN:DET3 EAV Set detector 3 to EMI Average. FSC:FIN:DET3?
<b>Notes</b>	Not affected by Mode Preset, preset by Restore Mode Defaults.
<b>Dependencies</b>	The Average and EMI detectors are mutually exclusive. If the Average detector is selected, the other three EMI Detectors are grayed out, and vice versa. If the grayed out key is pressed, an advisory message is generated. If the equivalent remote command is sent, this same message is generated as part of a “-221, Settings conflict” warning. This key is grayed out during final measurement. If the grayed out key is pressed, an advisory message is generated. If the equivalent SCPI command is sent, this same message is generated as part of a “-221, Settings conflict” warning.
<b>Couplings</b>	If the Measure at Marker window is being displayed, and one of the detectors is changed, any value being displayed for that detector changes to “---“ until the next successful reading from that detector. Any change of detector type will not be reflected on the signal list, until the next Final Measurement or Measure at Marker → List operation. Any values being displayed for that detector changes to “---“; until you perform a remeasure function for all the frequency values.
<b>Preset</b>	POSitive QPEak EAverage
<b>State Saved</b>	Saved in instrument state.
<b>Range</b>	Peak Quasi Peak EMI Average RMS Average Average Negative Peak Off
<b>Initial S/W Revision</b>	A.07.00

## Limit for $\Delta$

Selects the limit used by each final detector or measure at marker to get the limit delta value that goes in the Signal List. If you use the front panel to change the detector type, the following message will appear to remind you that the change of detector will cause the data of the particular detector type column to be discarded.

Changing limit for delta will discard the delta values, are you sure you want to do this?

Please press ENTER or OK to proceed. Press ESC or Cancel to close this dialog.

Key Path	Meas Setup, Detectors (Measure)
Remote Command	[ :SENSe ] :FSCan:FINal:DETEctor [1]   2   3 :LDELta <limit Num> [ :SENSe ] :FSCan:FINal:DETEctor [1]   2   3 :LDELta?
Example	:FSC:FIN:DET3:LDEL 2 Set limit line 2 to be used by detector 3.
Notes	Not affected by Mode Preset, preset by Restore Mode Defaults.
Dependencies	This key is grayed out during final measurement. If the grayed out key is pressed, an advisory message is generated. If the equivalent SCPI command is sent, this same message is generated as part of a “-221, Settings conflict” warning.
Preset	1 1 1
State Saved	Saved in instrument state.
Range	1 2 3 4 5 6
Initial S/W Revision	A.07.00

## Center Presel On/Off

Controls the automatic centering of the preselector for the Measure at Marker function.

When Center Presel is On, the first step in performing the Measure at Marker function is to perform a Presel Center. This is not performed if the microwave preselector is off, or the selected marker’s frequency is below Band 1. If the function is not performed, no message is generated.

Key Path	Marker Function
Remote Command	:CALCulate:FSCan:MAMarker:PCENter ON OFF 1 0 :CALCulate:FSCan:MAMarker:PCENter?
Example	CALC:FSC:MAM:PCEN ON
Dependencies	Blank in some non MXE instruments that do not include a preselector, such as MXA with option 503. If a SCPI command is sent to these instruments, it is accepted without error, and the query always returns 0.
Preset	ON
State Saved	Saved in instrument state
Range	ON OFF
Initial S/W Revision	A.07.00

## Marker Zoom

Zooms the graticule display at the selected marker to 10% of current span.

Key Path	Marker Function
Remote Command	:CALCulate:FSCan:MARKer [1]   2   . . .   12 :FUNCTion:ZOOM
Example	CALC:FSC:MARK2:FUNC:ZOOM Perform marker zoom at Marker 2.

Notes	<p>If the selected marker is parked at a point near to the edge of the trace data, the span after zoom will remain at 10% of span.</p> <p>If the selected marker is parked at a point out of current display, the start/stop frequencies will be set to Auto first to full zoom out before performing Marker Zoom. The marker will be moved to the center of the display if it is found located at a position out of the display after full zoom out.</p>
Dependencies	This key is grayed out when the marker has reached full zoom. If the grayed out key is pressed, an advisory message is generated. If the equivalent SCPI command is sent, this same message is generated as part of a “-200, Execution error” warning.
Couplings	The Start and Stop Frequency will be changed to accommodate the new span upon a marker zoom. They are set to Manual as a result. To get back the Start/Stop settings prior to a signal zoom, you can select Marker Zoom Out that turns the Start/Stop Frequency into Auto, which will automatically pick up the start/ stop setting for ranges turned on in the Scan table.
Initial S/W Revision	A.07.00

## Marker Zoom Out

Returns the graticule display to its previous display by setting the Start and Stop frequencies to the previous values set before the current Marker Zoom.

Key Path	Marker Function
<b>Remote Command</b>	:CALCulate:FSCan:MARKer:FUNction:ZOOM:OUT
<b>Example</b>	CALC:FSC:MARK:FUNC:ZOOM:OUT
Initial S/W Revision	A.07.00

## Marker To

Displays the menu keys that enable you to append new elements into the existing signal list.

Key Path	Front-panel key
Notes	Front panel only.
Initial S/W Revision	A.07.00

### Marker → List

Appends the frequency where the selected marker is in the signal list. The location of the newly added signal depends on the auto sort setting. If the trace detector matches the signal list detector, the corresponding amplitude and limit delta values will be updated. Otherwise, the values will be shown as "--" to indicate an undefined value.

Key Path	Marker To
Remote Command	:CALCulate:FSCan:MARKer[1] 2 ... 12[:SET]:SLIS
Example	CALC:FSC:MARK2:SLIS
Notes	If there is no free space in the signal list, the following prompt message will ask you whether to continue: WARNING! There is not enough free space in Signal List. Would you like to clear the Signal list before adding signals? Press ENTER to continue or ESC to Cancel.
Couplings	If no marker is ON when this operation is performed, the default marker will be turned on. The newly added signal will become the selected signal in the list.
Initial S/W Revision	A.07.00

### Meas at Mkr Result → List

Appends the current measure at marker results into the signal list, which include the frequency, measure at marker amplitude values and delta to limit values. For either case of detector or delta for limit lines is set to off, the values will be shown as "---" in the signal list to indicate the value is undefined.

If no valid measure at marker or final measurement is performed, an error is generated and a Measure at Marker → List cannot be performed.

Key Path	Marker To
Remote Command	:CALCulate:FSCan:MAMarker[:SET]:SLIS
Example	CALC:FSC:MAM:SLIS
Notes	If you perform a final measurement before selecting Measure at Marker → List, the last final measurement signal will be added to the list.  If there is no free space in the signal list, the following prompt message will ask you whether to continue: WARNING! There is not enough free space in Signal List. Would you like to clear the Signal list before adding signals? Press ENTER to continue or ESC to Cancel.
Couplings	The newly added signal will become the selected signal in the list.
Initial S/W Revision	A.07.00



**Mkr → Meters (Move Meters to Marker Freq)**

Replaces Frequency (Meters) with the frequency identified by the selected marker.

Key Path	Marker To
<b>Remote Command</b>	:CALCulate:FSCan:MARKer[1] 2 ... 12:TO:METer
<b>Example</b>	CALC:FSC:MARK2:TO:MET
Couplings	If no marker is ON when this operation is performed, the default marker will be turned on.
Initial S/W Revision	A.07.00

**Meters→ Mkr (Move Marker to Meters Freq)**

Replaces the frequency of the selected marker with Frequency (Meters). If the Meters frequency is out of the current span, an error is generated and the marker is not moved.

Key Path	Marker To
<b>Remote Command</b>	:CALCulate:FSCan:MARKer[1] 2 ... 12[:SET]:METer
<b>Example</b>	CALC:FSC:MARK2:MET
Couplings	If no marker is ON when this operation is performed, the default marker will be turned on.
Initial S/W Revision	A.07.00

**Meters → Signal (Replace)**

Replaces the frequency of the selected signal with Frequency (Meters). Amplitude values and the Delta To Limit values will be shown as “---” to indicate an undefined value.

Key Path	Marker To
<b>Remote Command</b>	:CALCulate:FSCan:SLIS:REPLace:METer <integer>
<b>Example</b>	CALC:FSC:SLIS:REPL:MET 20 Replace Signal #20 with signal obtained at the meters.
Notes	If the signal list contains no data, an error is generated and this function cannot be performed. If the selected signal is not in the list, an error is generated and this function cannot be performed.
Initial S/W Revision	A.07.00

**Meters → List (Append)**

Appends the signal obtained at meters into the signal list. Amplitude values and the Delta To Limit values will be shown as “---” to indicate an undefined value.

Key Path	Marker To
----------	-----------

<b>Remote Command</b>	:CALCulate:FSCan:SLIS:APPend:METer
<b>Example</b>	CALC:FSC:SLIS:APP:MET Append signal obtained at meters into signal list.
<b>Notes</b>	If there is no free space in the signal list, the following prompt message will ask you whether to continue or not: WARNING! There is not enough free space in Signal List. Would you like to clear the Signal list before adding signals? Press ENTER to continue or ESC to Cancel.
<b>Couplings</b>	The appended signal will be the selected signal after a Meters→ List is performed.
<b>Initial S/W Revision</b>	A.07.00

### Snap to Meters (Select Closest Signal)

Changes the selected signal to the closest signal in the Signal List to where the meters frequency is tuned.

<b>Key Path</b>	Marker To
<b>Remote Command</b>	:CALCulate:FSCan:SLIS:SNAP:METers
<b>Example</b>	CALC:FSC:SLIS:SNAP:MET
<b>Notes</b>	If there are two signals with equal frequency difference found, the signal with lower frequency will be selected. If the signal list contains no data, an error is generated and this function cannot be performed.
<b>Initial S/W Revision</b>	A.07.00

## Meas

The information in this section is common to all measurements. For key and remote command information for a specific measurement, refer to the section that describes the measurement of interest.

Measurements available under the Meas key are specific to the current Mode.

When viewing Help for measurements, note the following:

**NOTE**

Operation for some keys differs between measurements. The information displayed in Help pertains to the current measurement. To see how a key operates in a different measurement, exit Help (press the Cancel Esc key), select the measurement, then reenter Help (press the Help key) and press that key.

---

Key Path	Front-panel key
Initial S/W Revision	Prior to A.02.00

---

### Remote Measurement Functions

This section contains the following topics:

"Measurement Group of Commands" on page 1048

"Current Measurement Query (Remote Command Only)" on page 1050

"Limit Test Current Results (Remote Command Only)" on page 1050

"Data Query (Remote Command Only)" on page 1050

"Calculate/Compress Trace Data Query (Remote Command Only)" on page 1051

"Calculate Peaks of Trace Data (Remote Command Only)" on page 1056

Hardware-Accelerated Fast Power Measurement (Remote Command Only)

"Format Data: Numeric Data (Remote Command Only)" on page 1057

"Format Data: Byte Order (Remote Command Only)" on page 1058

---

Initial S/W Revision	Prior to A.02.00
----------------------	------------------

---

## Measurement Group of Commands

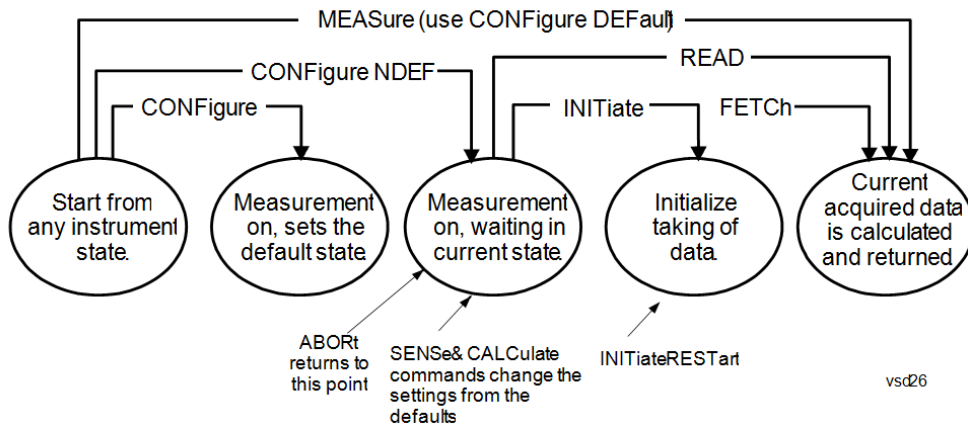

---

### Measure Commands:

:MEASure:<measurement>[n]?

This is a fast single-command way to make a measurement using the factory default instrument settings. These are the settings and units that conform to the Mode Setup settings (e.g. radio standard) that you have currently selected.

- Stops the current measurement (if any) and sets up the instrument for the specified measurement using the factory defaults
- Initiates the data acquisition for the measurement
- Blocks other SCPI communication, waiting until the measurement is complete before returning results.
- If the function does averaging, it is turned on and the number of averages is set to 10.
- After the data is valid it returns the scalar results, or the trace data, for the specified measurement. The type of data returned may be defined by an [n] value that is sent with the command.
- The scalar measurement results will be returned if the optional [n] value is not included, or is set to 1. If the [n] value is set to a value other than 1, the selected trace data results will be returned. See each command for details of what types of scalar results or trace data results are available.
- ASCII is the default format for the data output. (Older versions of Spectrum Analysis and Phase Noise mode measurements only use ASCII.) The binary data formats should be used for handling large blocks of data since they are smaller and faster than the ASCII format. Refer to the FORMat:DATA command for more information.

If you need to change some of the measurement parameters from the factory default settings you can set up the measurement with the CONFigure command. Use the commands in the SENSE:<measurement> and CALCulate:<measurement> subsystems to change the settings. Then you can use the READ? command to initiate the measurement and query the results.

If you need to repeatedly make a given measurement with settings other than the factory defaults, you can use the commands in the SENSE:<measurement> and CALCulate:<measurement> subsystems to set up the measurement. Then use the READ? command to initiate the measurement and query results.

Measurement settings persist if you initiate a different measurement and then return to a previous one. Use READ:<measurement>? if you want to use those persistent settings. If you want to go back to the default settings, use MEASure:<measurement>?.

---

### Configure Commands:

:CONFigure:<measurement>

This command stops the current measurement (if any) and sets up the instrument for the specified measurement using

---

---

the factory default instrument settings. It does not initiate the taking of measurement data unless INIT:CONTInuous is ON. If you change any measurement settings after using the CONFigure command, the READ command can be used to initiate a measurement without changing the settings back to their defaults.

In the Swept SA measurement in Spectrum Analyzer mode the CONFigure command also turns the averaging function on and sets the number of averages to 10 for all measurements.

:CONFigure: <measurement>: NDEFault stops the current measurement and changes to the specified measurement. It does not change the settings to the defaults. It does not initiate the taking of measurement data unless INIT:CONTInuous is ON.

The CONFigure? query returns the current measurement name.

The CONFigure:CATalog? query returns a quoted string of all licensed measurement names in the current mode. For example, "SAN, CHP, OBW, ACP, PST, TXP, SPUR, SEM, LIST".

---

#### Fetch Commands:

---

:FETCh:<measurement>[n]?

This command puts selected data from the most recent measurement into the output buffer. Use FETCh if you have already made a good measurement and you want to return several types of data (different [n] values, for example, both scalars and trace data) from a single measurement. FETCh saves you the time of re-making the measurement. You can only FETCh results from the measurement that is currently active, it will not change to a different measurement. An error message is reported if a measurement other than the current one is specified.

If you need to get new measurement data, use the READ command, which is equivalent to an INITiate followed by a FETCh.

The scalar measurement results will be returned if the optional [n] value is not included, or is set to 1. If the [n] value is set to a value other than 1, the selected trace data results will be returned. See each command for details of what types of scalar results or trace data results are available. The binary data formats should be used for handling large blocks of data since they are smaller and transfer faster than the ASCII format. (FORMat:DATA)

FETCh may be used to return results other than those specified with the original READ or MEASure command that you sent.

---

#### INITiate Commands:

---

:INITiate:<measurement>

This command is not available for measurements in all the instrument modes:

- Initiates a trigger cycle for the specified measurement, but does not output any data. You must then use the FETCh<meas> command to return data. If a measurement other than the current one is specified, the instrument will switch to that measurement and then initiate it.
  - For example, suppose you have previously initiated the ACP measurement, but now you are running the channel power measurement. If you send INIT:ACP? it will change from channel power to ACP and will initiate an ACP measurement.
  - Does not change any of the measurement settings. For example, if you have previously started the ACP measurement and you send INIT:ACP? it will initiate a new ACP measurement using the same instrument settings as the last time ACP was run.
  - If your selected measurement is currently active (in the idle state) it triggers the measurement, assuming the trigger conditions are met. Then it completes one trigger cycle. Depending upon the measurement and the number of averages, there may be multiple data acquisitions, with multiple trigger events, for one full trigger cycle. It also holds off additional commands on GPIB until the acquisition is complete.
- 

#### READ Commands:

---

:READ:<measurement>[n]?

- Does not preset the measurement to the factory default settings. For example, if you have previously initiated the ACP
-

---

measurement and you send READ:ACP? it will initiate a new measurement using the same instrument settings.

- Initiates the measurement and puts valid data into the output buffer. If a measurement other than the current one is specified, the instrument will switch to that measurement before it initiates the measurement and returns results.
  - For example, suppose you have previously initiated the ACP measurement, but now you are running the channel power measurement. Then you send READ:ACP? It will change from channel power back to ACP and, using the previous ACP settings, will initiate the measurement and return results.
  - Blocks other SCPI communication, waiting until the measurement is complete before returning the results
  - If the optional [n] value is not included, or is set to 1, the scalar measurement results will be returned. If the [n] value is set to a value other than 1, the selected trace data results will be returned. See each command for details of what types of scalar results or trace data results are available. The binary data formats should be used when handling large blocks of data since they are smaller and faster than the ASCII format. (FORMat:DATA)
- 

---

Initial S/W Revision	Prior to A.02.00
----------------------	------------------

---

### Current Measurement Query (Remote Command Only)

This command returns the name of the measurement that is currently running.

---

<b>Remote Command</b>	:CONFigure?
-----------------------	-------------

<b>Example</b>	CONF?
----------------	-------

Initial S/W Revision	Prior to A.02.00
----------------------	------------------

---

### Limit Test Current Results (Remote Command Only)

Queries the status of the current measurement limit testing. It returns a 0 if the measured results pass when compared with the current limits. It returns a 1 if the measured results fail any limit tests.

---

<b>Remote Command</b>	:CALCulate:CLIMits:FAIL?
-----------------------	--------------------------

<b>Example</b>	CALC:CLIM:FAIL? queries the current measurement to see if it fails the defined limits. Returns a 0 or 1: 0 it passes, 1 it fails.
----------------	--

Initial S/W Revision	Prior to A.02.00
----------------------	------------------

---

### Data Query (Remote Command Only)

Returns the designated measurement data for the currently selected measurement and subopcode.

n = any valid subopcode for the current measurement. See the measurement command results table for your current measurement, for information about what data is returned for the subopcodes.

This command uses the data setting specified by the FORMat:BORDER and FORMat:DATA commands and can return real or ASCII data. (See the format command descriptions under Input/Output in the Analyzer Setup section.)

<b>Remote Command</b>	:CALCulate:DATA[n]?
<b>Notes</b>	The return trace depends on the measurement. In CALCulate:<meas>:DATA[n], n is any valid subopcode for the current measurement. It returns the same data as the FETCH:<measurement>? query where <measurement> is the current measurement.
<b>Initial S/W Revision</b>	Prior to A.02.00

### Calculate/Compress Trace Data Query (Remote Command Only)

Returns compressed data for the currently selected measurement and sub-opcode [n].

n = any valid sub-opcode for that measurement. See the MEASure:<measurement>? command description of your specific measurement for information on the data that can be returned.

The data is returned in the current Y Axis Unit of the analyzer. The command is used with a sub-opcode <n> (default=1) to specify the trace. With trace queries, it is best if the analyzer is not sweeping during the query. Therefore, it is generally advisable to be in Single Sweep, or Update=Off.

This command is used to compress or decimate a long trace to extract and return only the desired data. A typical example would be to acquire N frames of GSM data and return the mean power of the first burst in each frame. The command can also be used to identify the best curve fit for the data.

<b>Remote Command</b>	:CALCulate:DATA<n>:COMPRESS? BLOCK   CFIT   MAXimum   MINimum   MEAN   DMEan   RMS   RMSCubed   SAMPLE   SDEVIation   PPHase [,<soffset> [,<length>[,<roffset>[,<rlimit>]]]]
<b>Example</b>	To query the mean power of a set of GSM bursts: Supply a signal that is a set of GSM bursts. Select the IQ Waveform measurement (in IQ Analyzer Mode). Set the sweep time to acquire at least one burst. Set the triggers such that acquisition happens at a known position relative to a burst. Then query the mean burst levels using, CALC:DATA2:COMP? MEAN, 24e-6, 526e-6 (These parameter values correspond to GSM signals, where 526e-6 is the length of the burst in the slot and you just want 1 burst.)
<b>Notes</b>	The command supports 5 parameters. Note that the last 4 (<soffset>, <length>, <roffset>, <rlimit>) are optional. But these optional parameters must be entered in the specified order. For example, if you want to specify <length>, then you must also specify <soffset>. See details below for a definition of each of these parameters.  This command uses the data in the format specified by FORMat:DATA, returning either binary or ASCII data.
<b>Initial S/W Revision</b>	Prior to A.02.00

- BLOCK or block data - returns all the data points from the region of the trace data that you specify. For example, it could be used to return the data points of an input signal over several timeslots, excluding the portions of the trace data that you do not want. (This is x,y pairs for trace data and I,Q pairs for complex data.)

- CFIT or curve fit - applies curve fitting routines to the data. <soffset> and <length> are required to define the data that you want. <roffset> is an optional parameter for the desired order of the curve equation. The query will return the following values: the x-offset (in seconds) and the curve coefficients ((order + 1) values).

MIN, MAX, MEAN, DME, RMS, RMSC, SAMP, SDEV and PPH return one data value for each specified region (or <length>) of trace data, for as many regions as possible until you run out of trace data (using <roffset> to specify regions). Or they return the number of regions you specify (using <rlimit>) ignoring any data beyond that.

- MINimum - returns the minimum data point (y value) for the specified region(s) of trace data. For I/Q trace data, the minimum magnitude of the I/Q pairs is returned.
- MAXimum - returns the maximum data point (y value) for the specified region(s) of trace data. For I/Q trace data, the maximum magnitude of the I/Q pairs is returned.
- MEAN - returns a single value that is the arithmetic mean of the data point values (in dB/ dBm) for the specified region(s) of trace data. For I/Q trace data, the mean of the magnitudes of the I/Q pairs is returned. See the following equations.

**NOTE** If the original trace data is in dB, this function returns the arithmetic mean of those log values, not log of the mean power which is a more useful value. The mean of the log is the better measurement technique when measuring CW signals in the presence of noise. The mean of the power, expressed in dB, is useful in power measurements such as Channel Power. To achieve the mean of the power, use the RMS option.

Equation 1

Mean Value of Data Points for Specified Region(s)

$$\text{MEAN} = \frac{1}{n} \sum_{X_i \in \text{region}(s)} X_i$$

where  $X_i$  is a data point value, and  $n$  is the number of data points in the specified region(s).

Equation 2

Mean Value of I/Q Data Pairs for Specified Region(s)

$$\text{MEAN} = \frac{1}{n} \sum_{X_i \in \text{region}(s)} |X_i|$$

where  $|X_i|$  is the magnitude of an I/Q pair, and  $n$  is the number of I/Q pairs in the specified region(s).

- DMEan - returns a single value that is the mean power (in dB/ dBm) of the data point values for the specified region(s) of trace data. See the following equation:

Equation 3

DMEan Value of Data Points for Specified Region(s)



$$\text{DME} = 10 \times \log_{10} \left( \frac{1}{n} \sum_{X_i \in \text{region}(s)} 10^{\frac{X_i}{10}} \right)$$

- RMS - returns a single value that is the average power on a root-mean-squared voltage scale (arithmetic rms) of the data point values for the specified region(s) of trace data. See the following equation.

**NOTE** For I/Q trace data, the rms of the magnitudes of the I/Q pairs is returned. See the following equation. This function is very useful for I/Q trace data. However, if the original trace data is in dB, this function returns the rms of the log values which is not usually needed.

Equation 4

RMS Value of Data Points for Specified Region(s)

$$\text{RMS} = \sqrt{\frac{1}{n} \sum_{X_i \in \text{region}(s)} X_i^2}$$

where  $X_i$  is a data point value, and  $n$  is the number of data points in the specified region(s).

Equation 5

RMS Value of I/Q Data Pairs for Specified Region(s)

$$\text{RMS} = \sqrt{\frac{1}{n} \sum_{X_i \in \text{region}(s)} X_i X_i^*}$$

where  $X_i$  is the complex value representation of an I/Q pair,  $X_i^*$  its conjugate complex number, and  $n$  is the number of I/Q pairs in the specified region(s).

Once you have the rms value for a region of trace data (linear or I/Q), you may want to calculate the mean power. You must convert this rms value (peak volts) to power in dBm:

$$10 \times \log[10 \times (\text{rms value})^2]$$

- SAMPLe - returns the first data value (x,y pair) for the specified region(s) of trace data. For I/Q trace data, the first I/Q pair is returned.
- SDEViation - returns a single value that is the arithmetic standard deviation for the data point values for the specified region(s) of trace data. See the following equation.
- For I/Q trace data, the standard deviation of the magnitudes of the I/Q pairs is returned. See the following equation.

Equation 6

Standard Deviation of Data Point Values for Specified Region(s)

$$\text{SDEV} = \sqrt{\frac{1}{n} \sum_{X_i \in \text{region}(s)} (X_i - \bar{X})^2}$$

where  $X_i$  is a data point value,  $\bar{X}$  is the arithmetic mean of the data point values for the specified region (s), and  $n$  is the number of data points in the specified region(s).

$$\text{SDEV} = \sqrt{\frac{1}{n} \sum_{X_i \in \text{region}(s)} (|X_i| - \bar{X})^2}$$

where  $|X_i|$  is the magnitude of an I/Q pair,  $\bar{X}$  is the mean of the magnitudes for the specified region(s), and  $n$  is the number of data points in the specified region(s).

- PPHase - returns the x,y pairs of both rms power (dBm) and arithmetic mean phase (radian) for every specified region and frequency offset (Hz). The number of pairs is defined by the specified number of regions. This parameter can be used for I/Q vector ( $n=0$ ) in Waveform (time domain) measurement and all parameters are specified by data point in PPHase.

The rms power of the specified region may be expressed as:

$$\text{Power} = 10 \times \log [10 \times (\text{RMS I/Q value})] + 10.$$

The RMS I/Q value (peak volts) is:

$$\sqrt{\frac{1}{n} \sum_{X_i \in \text{region}} X_i X_i^*}$$

where  $X_i$  is the complex value representation of an I/Q pair,  $X_i^*$  its conjugate complex number, and  $n$  is the number of I/Q pairs in the specified region.

The arithmetic mean phase of the specified region may be expressed as:

$$\frac{1}{n} \sum_{Y_i \in \text{region}} Y_i$$

where  $Y_i$  is the unwrapped phase of I/Q pair with applying frequency correction and  $n$  is the number of I/Q pairs in the specified region.

The frequency correction is made by the frequency offset calculated by the arithmetic mean of every specified region's frequency offset. Each frequency offset is calculated by the least square method against the unwrapped phase of I/Q pair.

Sample Trace Data - Constant Envelope

(See below for explanation of variables.)

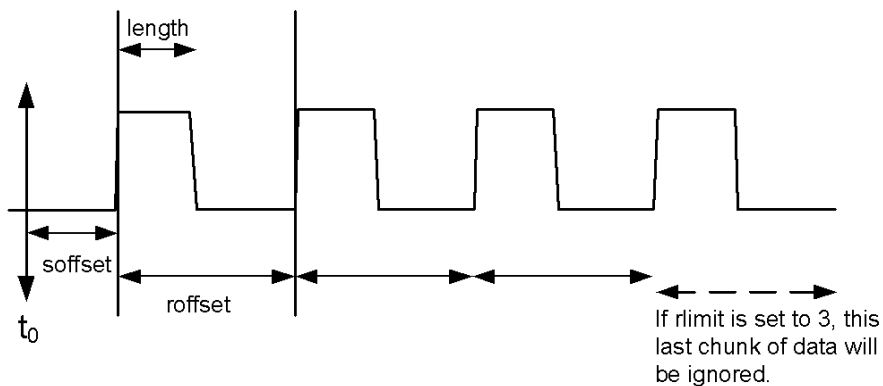

## Sample Trace Data - Not Constant Envelope

(See below for explanation of variables.)



<soffset> - start offset is an optional real number. (It is in seconds for time-domain traces, and is a dimensionless index 0 to Npoints - 1, for frequency-domain traces). It specifies the amount of data at the beginning of the trace that will be ignored before the decimation process starts. It is the time or frequency change from the start of the trace to the point where you want to start using the data. The default value is zero.

<length> - is an optional real number. (It is in seconds for time-domain traces, and is a dimensionless index 0 to Npoints - 1, for frequency-domain traces). It defines how much data will be compressed into one value. This parameter has a default value equal to the current trace length.

<roffset> - repeat offset is an optional real number. (It is in seconds for time-domain traces, and is a dimensionless index 0 to Npoints - 1, for frequency-domain traces). It defines the beginning of the next field of trace elements to be compressed. This is relative to the beginning of the previous field. This parameter has a default value equal to the <length> variable. Note that this parameter is used for a completely different purpose when curve fitting (see CFIT above).

<rlimit> - repeat limit is an optional integer. It specifies the number of data items that you want returned. It will ignore any additional items beyond that number. You can use the Start offset and the Repeat limit to pick out exactly what part of the data you want to use. The default value is all the data.

## Calculate Peaks of Trace Data (Remote Command Only)

Returns a list of all the peaks for the currently selected measurement and sub-opcode [n]. The peaks must meet the requirements of the peak threshold and excursion values.

n = any valid sub-opcode for the current measurement. See the MEASure:<measurement> command description of your specific measurement for information on the data that can be returned.

The command can only be used with specific sub-opcodes with measurement results that are trace data. Both real and complex traces can be searched, but complex traces are converted to magnitude in dBm. In many measurements the sub-opcode n=0, is the raw trace data which cannot be searched for peaks. And Sub-opcode n=1, is often calculated results values which also cannot be searched for peaks.

This command uses the data setting specified by the FORMat:BORDER and FORMat:DATA commands and can return real or ASCII data. If the format is set to INT,32, it returns REAL,32 data.

The command has four types of parameters:

- Threshold (in dBm)
- Excursion (in dB)
- Sorting order (amplitude, frequency, time)
- Optional in some measurements: Display line use (all, > display line, < display line)

---

<b>Remote Command</b>	<p>For Swept SA measurement:</p> <pre>:CALCulate:DATA[1] 2 ... 6:PEAKs? &lt;threshold&gt;,&lt;excursion&gt;[,AMPLitude   FREQuency   TIME[,ALL   GTDLLine   LTDLine]]</pre> <p>For most other measurements:</p> <pre>:CALCulate:DATA[1] 2 ... 6:PEAKs? &lt;threshold&gt;,&lt;excursion&gt;[,AMPLitude   FREQuency   TIME]</pre>
-----------------------	---

---

<b>Example</b>	<p>Example for Swept SA measurement in Spectrum Analyzer Mode:</p> <p>CALC:DATA4:PEAK? -40, 10, FREQ, GTDL This will identify the peaks of trace 4 that are above -40 dBm, with excursions of at least 10 dB. The peaks are returned in order of increasing frequency, starting with the lowest frequency. Only the peaks that are above the display line are returned.</p> <p>Query Results 1:</p> <p>With FORMat:DATA REAL, 32 selected, it returns a list of floating-point numbers. The first value in the list is the number of peak points that are in the following list. A peak point consists of two values: a peak amplitude followed by its corresponding frequency (or time).</p> <p>If no peaks are found the peak list will consist of only the number of peaks, (0).</p>
----------------	---

---

<b>Notes</b>	<p>&lt;n&gt; - is the trace that will be used</p> <p>&lt;threshold&gt; - is the level below which trace data peaks are ignored. Note that the threshold value is required and is always used as a peak criterion. To effectively disable the threshold criterion for this command, provide a substantially low threshold value such as -200 dBm. Also note that the threshold value used in this command is independent of and has no effect on the threshold value stored under the Peak Criteria menu.</p> <p>&lt;excursion&gt; - is the minimum amplitude variation (rise and fall) required for a signal to be identified as peak. Note that the excursion value is required and is always used as a peak criterion. To effectively disable the excursion criterion for this command, provide the minimum value of 0.0 dB. Also note that the excursion value used in this command is independent of and has no effect on the</p>
--------------	---

---

excursion value stored under the Peak Criteria menu.

Values must be provided for threshold and excursion. The sorting and display line parameters are optional (defaults are AMPLitude and ALL).

Note that there is always a Y-axis value for the display line, regardless of whether the display line state is on or off. It is the current Y-axis value of the display line which is used by this command to determine whether a peak should be reported

Sorting order:

AMPLitude - lists the peaks in order of descending amplitude, with the highest peak first (default if optional parameter not sent)

FREQUency - lists the peaks in order of occurrence, left to right across the x-axis.

TIME - lists the peaks in order of occurrence, left to right across the x-axis.

Peaks vs. Display Line:

ALL - lists all of the peaks found (default if optional parameter not sent).

GTDLine (greater than display line) - lists all of the peaks found above the display line.

LTDLine (less than display line) - lists all of the peaks found below the display line.

Initial S/W Revision      Prior to A.02.00

### Format Data: Numeric Data (Remote Command Only)

This command specifies the format of the trace data input and output. It specifies the formats used for trace data during data transfer across any remote port. It affects only the data format for setting and querying trace data for the :TRACe[:DATA], TRACe[:DATA]?, :CALCulate:DATA[n]? and FETCh:SANalyzer [n]? commands and queries.

**Remote Command**      :FORMat[:TRACe] [:DATA] ASCii|INTeger,32|REAL,32 |REAL,64  
:FORMat[:TRACe] [:DATA]?

**Notes**      The query response is:  
ASCii: ASC,8  
REAL,32: REAL,32  
REAL,64: REAL,64  
INTeger,32: INT,32

When the numeric data format is REAL or ASCii, data is output in the current Y Axis unit. When the data format is INTeger, data is output in units of m dBm (.001 dBm).

The INT,32 format returns binary 32-bit integer values in internal units (m dBm), in a definite length block.

**Dependencies**      Sending a data format spec with an invalid number (for example, INT,48) generates no error. The analyzer simply uses the default (8 for ASCii, 32 for INTeger, 32 for REAL).

Sending data to the analyzer which does not conform to the current FORMat specified, results in an error. Sending ASCII data when a definite block is expected generates message -161 "Invalid Block Data" and sending a definite block when ASCII data is expected generates message -121 "Invalid Character in Number".

**Preset**      ASCii

**Backwards Compatibility Notes**      Note that the INT,32 format is only applicable to the command, TRACe:DATA. This preserves backwards compatibility for the Swept SA measurement. For all other commands/queries which honor FORMat:DATA, if INT,32 is sent the analyzer will behave as though it were set to REAL,32.

Initial S/W Revision      Prior to A.02.00

The specs for each output type follow:

ASCIi - Amplitude values are in ASCII, in the current Y Axis Unit, one ASCII character per digit, values separated by commas, each value in the form:

SX.YYYYYEsZZ

Where:

S = sign (+ or -)

X = one digit to left of decimal point

Y = 5 digits to right of decimal point

E = E, exponent header

s = sign of exponent (+ or -)

ZZ = two digit exponent

REAL,32 - Binary 32-bit real values in the current Y Axis Unit, in a definite length block.

REAL,64 - Binary 64-bit real values in the current Y Axis Unit, in a definite length block.

### Format Data: Byte Order (Remote Command Only)

This command selects the binary data byte order for data transfer and other queries. It controls whether binary data is transferred in normal or swapped mode. This command affects only the byte order for setting and querying trace data for the :TRACe[:DATA], TRACe[:DATA]? , :CALCulate:DATA[n]? and FETCh:SANalyzer[n]? commands and queries.

By definition any command that says it uses FORMat:DATA uses any format supported by FORMat:DATA.

The NORMal order is a byte sequence that begins with the most significant byte (MSB) first, and ends with the least significant byte (LSB) last in the sequence: 1|2|3|4. SWAPped order is when the byte sequence begins with the LSB first, and ends with the MSB last in the sequence: 4|3|2|1.

---

<b>Remote Command</b>	:FORMat:BORDER NORMal   SWAPped :FORMat:BORDER?
<b>Preset</b>	NORMal
<b>Initial S/W Revision</b>	Prior to A.02.00

---

## Meas Setup

Displays the menu keys that enable you to set up the measurement.

Key Path	Front-panel key
Notes	Front panel only.
Initial S/W Revision	A.07.00

## Select Signal

Specifies the selected signal. The term “Selected signal” is used throughout this document to specify which signal will be affected by the functions.

Key Path	Meas Setup
Notes	Front panel only. When Select Signal is the active function, press UP to go up in the signal list, and press DOWN to go down in the list.
Dependencies	Yes
Couplings	When the signal list is cleared, this value will reset to 0.
Preset	If the signal list is empty, =0 If the signal list is not empty, = number of peaks in signal list table
State Saved	Saved in instrument state.
Min	0
Max	Number of peaks in the signal list table.
Initial S/W Revision	A.07.00

## Meas Setup

Displays the menu keys that enable you to set up the measurement.

Key Path	Front-panel key
Notes	Front panel only.
Initial S/W Revision	A.07.00

## Select Signal

Specifies the selected signal. The term “Selected signal” is used throughout this document to specify which signal will be affected by the functions.

Key Path	Meas Setup
Notes	Front panel only. When Select Signal is the active function, press UP to go up in the signal list, and press DOWN to go down in the list.

Dependencies	Yes
Couplings	When the signal list is cleared, this value will reset to 0.
Preset	If the signal list is empty, =0 If the signal list is not empty, = number of peaks in signal list table
State Saved	Saved in instrument state.
Min	0
Max	Number of peaks in the signal list table.
Initial S/W Revision	A.07.00

## Navigate

This menu enables you to navigate through the signal list without using a mouse.

Key Path	Meas Setup, Signal List
Initial S/W Revision	A.07.00

## Page Up

If the signal list fills more than one page, pressing this key moves the signal list up by one page.

Key Path	Meas Setup, Signal List, Navigate
Notes	Front panel only.
Dependencies	This key is grayed out when a scan sequence is running. If the grayed out key is pressed, an advisory message is generated. If the equivalent SCPI command is sent, this same message is generated as part of a “-221, Settings conflict” warning.
Initial S/W Revision	A.07.00

## Page Down

If the signal list fills more than one page, pressing this key moves the signal list down by one page.

Key Path	Meas Setup, Signal List, Navigate
Notes	Front panel only.
Dependencies	This key is grayed out when a scan sequence is running. If the grayed out key is pressed, an advisory message is generated. If the equivalent SCPI command is sent, this same message is generated as part of a “-221, Settings conflict” warning.
Initial S/W Revision	A.07.00



## Scroll Left

Scroll signal list to the left.

Key Path	Meas Setup, Signal List, Navigate
Notes	Front panel only.
Dependencies	This key is grayed out when a scan sequence is running. If the grayed out key is pressed, an advisory message is generated. If the equivalent SCPI command is sent, this same message is generated as part of a “-221, Settings conflict” warning.
Initial S/W Revision	A.07.00

## Scroll Right

Scroll signal list to the right.

Key Path	Meas Setup, Signal List, Navigate
Notes	Front panel only.
Dependencies	This key is grayed out when a scan sequence is running. If the grayed out key is pressed, an advisory message is generated. If the equivalent SCPI command is sent, this same message is generated as part of a “-221, Settings conflict” warning.
Initial S/W Revision	A.07.00

## Signal → Meters (Move Meters to Current Signal)

Replace Frequency (Meters) with the frequency of the selected signal.

Key Path	Meas Setup, Signal List, Navigate
<b>Remote Command</b>	:CALCulate:FSCan:SLIS:SET:METER <integer>
<b>Example</b>	CALC:FSC:SLIS:SET:MET 12 Set Freq (Meters) to frequency of Signal #12
Notes	If the signal list contains no data, an error is generated and this function cannot be performed. If the selected signal is not in the list, an error is generated and this function cannot be performed.
Dependencies	This key is grayed out when a scan sequence is running. If the grayed out key is pressed, an advisory message is generated. If the equivalent SCPI command is sent, this same message is generated as part of a “-221, Settings conflict” warning.
Initial S/W Revision	A.07.00

## Mark Signals

This menu enables you to mark signals for further processing. A ticked checkbox appears next to the signal number to distinguish them from unmarked signals.

Key Path	Meas Setup, Signal List
Initial S/W Revision	A.07.00

### Select Signal

Specifies the selected signal. The term “Selected signal” is used throughout this document to specify which signal will be affected by the functions.

Key Path	Meas Setup, Signal List, Mark Signals
Notes	Front panel only.
Dependencies	Yes
Couplings	When the signal list is cleared, this value will reset to 0.
Preset	If the signal list is empty, =0 If the signal list is not empty, = number of peaks in signal list table
State Saved	Saved in instrument state.
Min	0
Max	Number of peaks in signal list table.
Initial S/W Revision	A.07.00

### Mark Signal

Marks the checkbox next to the selected signal.

Key Path	Meas Setup, Signal List, Mark Signals
<b>Remote Command</b>	:CALCulate:FSCan:SLIS:MARK:SIGNal <integer>
<b>Example</b>	CALC:FSC:SLIS:MARK:SIGN 4 Mark signal #4.
Notes	If the signal list contains no data, an error is generated and this function cannot be performed. If the selected signal is not in the list, an error is generated and this function cannot be performed.
Dependencies	This key is grayed out when a scan sequence is running. If the grayed out key is pressed, an advisory message is generated. If the equivalent SCPI command is sent, this same message is generated as part of a “-221, Settings conflict” warning.
Initial S/W Revision	A.07.00

### Mark Duplicates

This menu enables you to mark the signals that are duplicates. A signal is considered to be a duplicate if it is within the width of the 3 dB RBW value. Signals cannot be duplicate unless they are measured using the same 3 dB RBW.

Key Path	Meas Setup, Signal List, Mark Signals
Initial S/W Revision	A.13.00

**All**

Marks all duplicate signals.

<b>Key Path</b>	Meas Setup, Signal List, Mark Signals, Mark Duplicates
<b>Remote Command</b>	:CALCulate:FSCan:SLIS:MARK:DUPLicates[:ALL]
<b>Example</b>	CALC:FSC:SLIS:MARK:DUPL
<b>Notes</b>	If the signal list contains no data, an error is generated and this function cannot be performed.
<b>Dependencies</b>	This key is grayed out when a scan sequence is running. If the grayed out key is pressed, an advisory message is generated. If the equivalent SCPI command is sent, this same message is generated as part of a “-221, Settings conflict” warning.
<b>Initial S/W Revision</b>	A.13.00

**Upper**

Marks duplicate signals with higher amplitudes.

<b>Key Path</b>	Meas Setup, Signal List, Mark Signals, Mark Duplicates
<b>Remote Command</b>	:CALCulate:FSCan:SLIS:MARK:DUPLicates:UPPer
<b>Example</b>	CALC:FSC:SLIS:MARK:DUPL:UPP
<b>Notes</b>	If the signal list contains no data, an error is generated and this function cannot be performed.
<b>Dependencies</b>	This key is grayed out when a scan sequence is running. If the grayed out key is pressed, an advisory message is generated. If the equivalent SCPI command is sent, this same message is generated as part of a “-221, Settings conflict” warning.
<b>Initial S/W Revision</b>	A.13.00

**Lower**

Marks duplicate signals with lower amplitudes.

<b>Key Path</b>	Meas Setup, Signal List, Mark Signals, Mark Duplicates
<b>Remote Command</b>	:CALCulate:FSCan:SLIS:MARK:DUPLicates:LOWer
<b>Example</b>	CALC:FSC:SLIS:MARK:DUPL:LOW
<b>Notes</b>	If the signal list contains no data, an error is generated and this function cannot be performed.
<b>Dependencies</b>	This key is grayed out when a scan sequence is running. If the grayed out key is pressed, an advisory message is generated. If the equivalent SCPI command is sent, this same message is generated as part of a “-221, Settings conflict” warning.
<b>Initial S/W Revision</b>	A.13.00

**Clear Mark**

Clears the mark from the selected signal.

Key Path	Meas Setup, Signal List, Mark Signals
Remote Command	:CALCulate:FSCan:SLIS:MARK:CLEar:SIGNal <integer>
Example	CALC:FSC:SLIS:MARK:CLE:SIGN 11 Clear mark from signal #11.
Notes	If the signal list contains no data, an error is generated and this function cannot be performed. If the selected signal is not in the list, an error is generated and this function cannot be performed.
Dependencies	This key is grayed out when a scan sequence is running. If the grayed out key is pressed, an advisory message is generated. If the equivalent SCPI command is sent, this same message is generated as part of a “-221, Settings conflict” warning.
Initial S/W Revision	A.07.00

### Mark All

Marks all signals in the signal list.

Key Path	Meas Setup, Signal List, Mark Signals
Remote Command	:CALCulate:FSCan:SLIS:MARK:ALL
Example	CALC:FSC:SLIS:MARK:ALL
Notes	If the signal list contains no data, an error is generated and this function cannot be performed.
Dependencies	This key is grayed out when a scan sequence is running. If the grayed out key is pressed, an advisory message is generated. If the equivalent SCPI command is sent, this same message is generated as part of a “-221, Settings conflict” warning.
Initial S/W Revision	A.07.00

### Clear All

Clears all the marks from the signal list.

Key Path	Meas Setup, Signal List, Mark Signals
Remote Command	:CALCulate:FSCan:SLIS:MARK:CLEar:ALL
Example	CALC:FSC:SLIS:MARK:CLE:ALL Clear mark from all signals.
Notes	If the signal list contains no data, an error is generated and this function cannot be performed.
Dependencies	This key is grayed out when a scan sequence is running. If the grayed out key is pressed, an advisory message is generated. If the equivalent SCPI command is sent, this same message is generated as part of a “-221, Settings conflict” warning.
Initial S/W Revision	A.07.00

### Delete Signals

This key opens the delete signals option menu.

Key Path	Meas Setup, Signal List
Initial S/W Revision	A.07.00

## Select Signal

Specifies the selected signal. The term “Selected signal” is used throughout this document to specify which signal will be affected by the functions.

Key Path	Meas Setup, Signal List, Delete Signals
Notes	Front panel only.
Dependencies	Yes
Couplings	When the signal list is cleared, this value will reset to 0.
Preset	If the signal list is empty, =0 If the signal list is not empty, = number of peaks in signal list table
State Saved	Saved in instrument state.
Min	0
Max	Number of peaks in signal list table.
Initial S/W Revision	A.07.00

## Delete Signal

Deletes the selected signal. If you accessed this function from the front panel, the following message will prompt you for confirmation to delete the selected signal from the signal list.

This will delete the selected signal. Are you sure you want to do this?

Please press Enter or OK to proceed. Press ESC or Cancel to close this dialog.

Key Path	Meas Setup, Signal List, Delete Signals
<b>Remote Command</b>	:CALCulate:FSCan:SLIS:DElete:SIGNal <integer>
<b>Example</b>	CALC:FSC:SLIS:DEL:SIGN 4 Delete signal #4.
Notes	If the signal list contains no data, an error is generated and this function cannot be performed. When signals in the signal list were successfully deleted, an advisory is generated. If the selected signal is not in the list, an error is generated and this function cannot be performed.
Dependencies	This key is grayed out when a scan sequence is running. If the grayed out key is pressed, an advisory message is generated. If the equivalent SCPI command is sent, this same message is generated as part of a “-221, Settings conflict” warning.
Initial S/W Revision	A.07.00

### Delete All

Marks and deletes all signals in the signal list. If you accessed this function from the front panel, the following message will prompt you for confirmation to delete all signals from the signal list.

This will delete all signals. Are you sure you want to do this?

Please press Enter or OK to proceed. Press ESC or Cancel to close this dialog.

<b>Key Path</b>	Meas Setup, Signal List, Delete Signals
<b>Remote Command</b>	:CALCulate:FSCan:SLIS:DElete:ALL
<b>Example</b>	CALC:FSC:SLIS:DEL:ALL
<b>Notes</b>	If the signal list contains no data, an error is generated and this function cannot be performed. When signals in the signal list were successfully deleted, an advisory is generated.
<b>Dependencies</b>	This key is grayed out when a scan sequence is running. If the grayed out key is pressed, an advisory message is generated. If the equivalent SCPI command is sent, this same message is generated as part of a “-221, Settings conflict” warning.
<b>Initial S/W Revision</b>	A.07.00

### Delete Marked

Deletes all marked signals in the signal list. If you accessed this function from the front panel, the following message will prompt you for confirmation to delete the selected signals from the signal list.

This will delete the marked signals. Are you sure you want to do this?

Please press Enter or OK to proceed. Press ESC or Cancel to close this dialog.

<b>Key Path</b>	Meas Setup, Signal List, Delete Signals
<b>Remote Command</b>	:CALCulate:FSCan:SLIS:DElete:MARKed
<b>Example</b>	CALC:FSC:SLIS:DEL:MARK
<b>Notes</b>	If the signal list contains no data, an error is generated and this function cannot be performed. If no marked signal is found in the signal list, an error is generated and Delete Marked cannot be performed. When signals in the signal list were successfully deleted, an advisory is generated.
<b>Dependencies</b>	This key is grayed out when a scan sequence is running. If the grayed out key is pressed, an advisory message is generated. If the equivalent SCPI command is sent, this same message is generated as part of a “-221, Settings conflict” warning.
<b>Initial S/W Revision</b>	A.07.00

### Delete Unmarked

Deletes all unmarked signals in the signal list. If you accessed this function from the front panel, the following message will prompt you for confirmation to delete the selected signals from the signal list.

This will delete the unmarked signals. Are you sure you want to do this?

Please press Enter or OK to proceed. Press ESC or Cancel to close this dialog.

Key Path	Meas Setup, Signal List, Delete Signals
Remote Command	:CALCulate:FSCan:SLIS:DElete:UNMarked
Example	CALC:FSC:SLIS:DEL:UNM
Notes	If the signal list contains no data, an error is generated and this function cannot be performed. When signals in the signal list were successfully deleted, an advisory is generated.
Dependencies	This key is grayed out when a scan sequence is running. If the grayed out key is pressed, an advisory message is generated. If the equivalent SCPI command is sent, this same message is generated as part of a “-221, Settings conflict” warning.
Initial S/W Revision	A.07.00

## Signal Zoom

Zooms the graticule display at the selected signal to 10% of the current span.

Key Path	Meas Setup, Signal List
Remote Command	:CALCulate:FSCan:SLIS:ZOOM <integer>
Example	CALC:FSC:SLIS:ZOOM 3 Perform signal zoom at Signal 3.
Notes	If the selected signal is parked at a point near to the edge of trace data, the span after zoom will remain at 10% of the span. If the selected signal is parked at a point out of current display, the start/stop frequencies will be set to Auto first to full zoom out before performing Signal Zoom.
Dependencies	This key is grayed out when it has reached full zoom. If the grayed out key is pressed, an advisory message is generated. If the equivalent SCPI command is sent, this same message is generated as part of a “-200, Execution error” warning. This key is grayed out when a scan sequence is running. If the grayed out key is pressed, an advisory message is generated. If the equivalent SCPI command is sent, this same message is generated as part of a “-221, Settings conflict” warning.
Couplings	The Start and Stop Frequency will be changed to accommodate the new span upon a signal zoom. They are set to Manual as a result. To get back the Start/Stop settings prior to signal zoom, you can select Zoom Out, which turns the Start/Stop Frequency into Auto. This will automatically pick up the start/ stop setting for ranges turned on in the Scan table.
Initial S/W Revision	A.07.00

## Zoom Out

Returns the graticule display to its previous display by setting the Start and Stop Frequencies to the previous values set before the current Signal Zoom.

Key Path	Meas Setup, Signal List
Remote Command	:CALCulate:FSCan:SLIS:ZOOM:OUT
Example	CALC:FSC:SLIS:ZOOM:OUT

Dependencies	<p>This key is grayed out before Marker Zoom is performed. If the grayed out key is pressed, an advisory message is generated. If the equivalent SCPI command is sent, this same message is generated as part of a “-200, Execution error” warning.</p> <p>This key is grayed out when a scan sequence is running. If the grayed out key is pressed, an advisory message is generated. If the equivalent SCPI command is sent, this same message is generated as part of a “-221, Settings conflict” warning.</p>
Initial S/W Revision	A.07.00

## Sort Signals

Specifies how the elements in the signal list will be sorted either based on the frequency, detector amplitude, detector vs. limit delta or time in ascending or descending order. During sorting, an advisory message appears at the message bar, “Sorting signal list by <sorting type selected>...”, for example:

Sorting signal list by Frequency...

Sorting signal list by Det 1 Amplitude...

Sorting signal list by Det 3 vs Limit Delta...

Sorting signal list by Det 3 vs TimeStamp...

Key Path	Meas Setup, Signal List, Sort Signals
Remote Command	<pre>:CALCulate:FSCan:SLIS:SORT:TYPE FREQUENCY   DAMPLITUDE   DLDELTA   TIME</pre> <pre>:CALCulate:FSCan:SLIS:SORT:TYPE?</pre>
Example	<pre>CALC:FSC:SLIS:SORT:TYPE FREQ</pre> <pre>CALC:FSC:SLIS:SORT:TYPE?</pre>
Dependencies	This key is grayed out when a scan sequence is running. If the grayed out key is pressed, an advisory message is generated. If the equivalent SCPI command is sent, this same message is generated as part of a “-221, Settings conflict” warning.
Couplings	Selecting a sorting mode (pressing the key or sending the equivalent SCPI command) will turn on the Auto Sort state, even if that sorting mode was already selected.
Preset	FREQUENCY
State Saved	Saved in instrument state.
Range	By Freq By Detector Amptd By ( Detector By Time
Initial S/W Revision	A.07.00

### By Freq

Specifies that the elements in the signal list will be sorted based on the frequency.

Key Path	Meas Setup, Signal List, Signal List, Sort Signals
Example	<pre>CALC:FSC:SLIS:SORT:TYPE FREQ</pre>
Initial S/W Revision	A.07.00



## By Det Amptd Type

Specifies that the elements in the signal list will be sorted based on the detector amplitude type.

Key Path	Meas Setup, Signal List, Sort Signals, By Detector Amplitude
Remote Command	:CALCulate:FSCan:SLIS:SORT:DAMPLitude DET1 DET2 DET3 :CALCulate:FSCan:SLIS:SORT:DAMPLitude ?
Example	CALC:FSC:SLIS:SORT:DAMP DET2 CALC:FSC:SLIS:SORT:DAMP?
Dependencies	This key is grayed out when a scan sequence is running. If the grayed out key is pressed, an advisory message is generated. If the equivalent SCPI command is sent, this same message is generated as part of a “-221, Settings conflict” warning.
Couplings	Selecting the detector amplitude type to be sorted (pressing the key or sending the equivalent SCPI command) will turn on the Auto Sort state, even if that detector amplitude type was already selected.
Preset	DET1
State Saved	Saved in instrument state.
Range	Detector 1 Detector 2 Detector 3
Initial S/W Revision	A.07.00

## By $\Delta$ Detector Type

Specifies that the elements in the signal list will be sorted based on the detector to limit delta type.

Key Path	Meas Setup, Signal List, Sort Signals, By $\Delta$ Detector
Remote Command	:CALCulate:FSCan:SLIS:SORT:DLDelta DET1 DET2 DET3 :CALCulate:FSCan:SLIS:SORT:DLDelta?
Example	CALC:FSC:SLIS:SORT:DLD DET2 CALC:FSC:SLIS:SORT:DLD?
Dependencies	This key is grayed out when a scan sequence is running. If the grayed out key is pressed, an advisory message is generated. If the equivalent SCPI command is sent, this same message is generated as part of a “-221, Settings conflict” warning.
Couplings	Selecting the $\Delta$ Detector type to be sorted (pressing the key or sending the equivalent SCPI command) will turn on the Auto Sort state, even if that $\Delta$ Detector type was already selected.
Preset	DET1
State Saved	Saved in instrument state.
Range	Detector 1 Detector 2 Detector 3
Initial S/W Revision	A.07.00

## By Time

Specifies that the elements in the signal list will be sorted based on time.

Key Path	Meas Setup, Signal List, Sort Signals
<b>Example</b>	CALC:FSC:SLIS:SORT:TYPE TIME
Initial S/W Revision	A.07.00

## Sort Order

Chooses between ascending and descending sort order.

Key Path	Meas Setup, Signal List, Sort Signals
<b>Remote Command</b>	:CALCulate:FSCan:SLIS:SORT:ORDER ASCending  DESCending :CALCulate:FSCan:SLIS:SORT:ORDER?
<b>Example</b>	CALC:FSC:SLIS:SORT:ORD DESC CALC:FSC:SLIS:SORT:ORD
Dependencies	This key is grayed out when a scan sequence is running. If the grayed out key is pressed, an advisory message is generated. If the equivalent SCPI command is sent, this same message is generated as part of a “-221, Settings conflict” warning.
Couplings	Selecting the sort order (pressing the key or sending the equivalent SCPI command) will turn on the Auto Sort state, even if that sort order was already selected.
Preset	ASCending
State Saved	Saved in instrument state.
Initial S/W Revision	A.07.00

## Auto Sort

If this is turned on, the measurement will perform signal sorting based on the sorting order and sorting type selected before each new signal is added. Otherwise, the signal will be added into the signal list in descending order of the trace amplitude level.

Key Path	Meas Setup, Signal List, Sort Signals
<b>Remote Command</b>	:CALCulate:FSCan:SLIS:SORT:AUTO ON OFF 1 0 :CALCulate:FSCan:SLIS:SORT:AUTO?
<b>Example</b>	CALC:FSC:SLIS:SORT:AUTO 1 Turn on auto sorting CALC:FSC:SLIS:SORT:AUTO?
Notes	If Scan Sequence is set to Remeasure, the signal in the list will only be auto sorted when a Remeasure is completed.
Dependencies	This key is grayed out when a scan sequence is running. If the grayed out key is pressed, an advisory message is generated. If the equivalent SCPI command is sent, this same message is generated as part of a “-221, Settings conflict” warning.

Preset	ON
State Saved	Saved in instrument state.
Range	On Off
Initial S/W Revision	A.07.00

## Comment

Sets an ASCII comment field for each signal in list, which will be shown in the “Comment” column of the signal list. This value will be stored in the signal list exported file.

Key Path	Meas Setup, Signal List
<b>Remote Command</b>	[ :SENSe ] :FSCan:SLIS:COMMeNt <integer>, “string” [ :SENSe ] :FSCan:SLIS:COMMeNt? <integer>
<b>Example</b>	:FSC:SLIS:COMM 2,“unknown”
Dependencies	This key is grayed out when a scan sequence is running. If the grayed out key is pressed, an advisory message is generated. If the equivalent SCPI command is sent, this same message is generated as part of a “-221, Settings conflict” warning.
Preset	” (null String), not affected by Mode Preset, preset by Restore Mode Defaults.
State Saved	Saved in instrument state.
Initial S/W Revision	A.07.00

## Step Control

Specifies the step control used for the scan table. If Step Size & Dwell Time is selected, the Step Size and Dwell Time keys will appear in the Scan Table. Otherwise, the Scan Points and Scan Time keys will be shown.

Key Path	Meas Setup
<b>Remote Command</b>	[ :SENSe ] :FSCan:SCAN:CONTRol SDWell STPoints [ :SENSe ] :FSCan:SCAN:CONTRol?
<b>Example</b>	FSC:SCAN:CONT SDW Select Step and Dwell FSC:SCAN:CONT?
Notes	SDWell = Step Size & Dwell Time STPoints = Scan Time & Points
Dependencies	This key is grayed out during multi range scanning. If the grayed out key is pressed, an advisory message is generated. If the equivalent SCPI command is sent, this same message is generated as part of a “-221, Settings conflict; Function not available while running multirange scan” warning. This key is grayed out during final measurement. If the grayed out key is pressed, an advisory message is generated. If the equivalent SCPI command is sent, this same message is generated as part of a “-221, Settings conflict” warning. This key is grayed out during a Time Domain Scan. If the grayed out key is pressed, an advisory

	message is generated. If the equivalent SCPI command is sent, this same message is generated as part of a “-221, Settings conflict; Function not available with time domain scan type” warning.
Couplings	When Time Domain is selected as the Scan Type, the Step Control is automatically set to Step Size & Dwell Time. Changing to another Scan Type from Time Domain does not alter the existing Step Control (i.e. it remains as Step Size and Dwell Time).
Preset	SDWell
State Saved	Saved in instrument state.
Range	Step Size & Dwell Time  Scan Time & Points
Readback	If the Step Control is Step and Dwell, will show “Step Size & Dwell Time” If the Step Control is Scan Time/ Points, will show “Scan Time&Pts”
Initial S/W Revision	A.07.00

## Scan Table

The scan table is used to enter the settings for up to ten ranges.

Key Path	Meas Setup
Initial S/W Revision	A.07.00

## Select Range

Specifies the selected range. The term “selected range” is used throughout this document to specify which range will be affected by the functions. There are a total of 10 ranges.

Key Path	Meas Setup, Scan Table
Notes	Front panel only. The selected range is remembered even when not in the Scan Table Menu.
Preset	Range 5.
State Saved	Saved in instrument state
Initial S/W Revision	A.07.00

## Range State

Sets the state of the selected range. If a Range is turned on, it will be used as part of the measurement. If it is off, it will be excluded.

Key Path	Meas Setup, Scan Table
Remote Command	[ :SENSe ] :FSCan:SCAN[1]   2   . . .   10 :STATe ON OFF 1 0 [ :SENSe ] :FSCan:SCAN[1]   2   . . .   10 :STATe?
Example	FSC:SCAN4:STAT 1 Turn on Range 4. FSC:SCAN4:STAT?

Dependencies	<p>This key is grayed out during multi range scanning. If the grayed out key is pressed, an advisory message is generated. If the equivalent SCPI command is sent, this same message is generated as part of a “-221, Settings conflict; Function not available while running multirange scan” warning.</p> <p>This key is grayed out during final measurement. If the grayed out key is pressed, an advisory message is generated. If the equivalent SCPI command is sent, this same message is generated as part of a “-221, Settings conflict” warning.</p>
Couplings	<p>If you turn on a selected range with a start frequency &lt; the previous range’s stop frequency (where the previous range is turned on), the stop frequency of the previous range will be changed to the selected range’s start frequency.</p> <p>If you turn on a selected range with a stop frequency &gt; the next range’s start frequency (where the previous range is turned on), the next range’s stop frequency will be changed to the start frequency of the selected range.</p> <p>If you turn on a selected range that results in the total range points exceeding 40001, the range state of the specific range will be changed to off. An advisory message is generated. If the equivalent SCPI command is sent, this same message is generated as part of a “-221, Settings conflict” warning.</p>
Preset	OFF OFF OFF OFF ON OFF OFF OFF OFF OFF
State Saved	Saved in instrument state.
Range	On Off
Initial S/W Revision	A.07.00

## Start Freq

Specifies the start frequency of the selected range.

Key Path	Meas Setup, Scan Table
Remote Command	<pre>[ :SENSe ] :FSCan:SCAN[1]   2   . . .   10 :START &lt;freq&gt;</pre> <pre>[ :SENSe ] :FSCan:SCAN[1]   2   . . .   10 :START?</pre>
Example	<pre>FSC:SCAN5:STAR 300e6 Set Start Freq of Range 5 to 300 MHz.</pre> <pre>FSC:SCAN5:STAR?</pre>
Notes	Max values depend on Hardware Options (503, 507, 508, 513, 526)
Dependencies	<p>This key is grayed out during multi range scanning. If the grayed out key is pressed, an advisory message is generated. If the equivalent SCPI command is sent, this same message is generated as part of a “-221, Settings conflict; Function not available while running multirange scan” warning.</p> <p>This key is grayed out during final measurement. If the grayed out key is pressed, an advisory message is generated. If the equivalent SCPI command is sent, this same message is generated as part of a “-221, Settings conflict” warning.</p> <p>By direct entry:</p> <p>You cannot set the Start frequency &gt; Stop frequency. You cannot set the Start frequency = Stop frequency. You cannot select zero span by setting Start = Stop. You cannot set the Start Frequency to a value that would create a span of less than 10 Hz. If you try to do any of these, the Stop Frequency will change to maintain a minimum value of 10 Hz for the difference between Start and Stop.</p> <p>With the knob or step keys:</p> <p>You cannot increment the Start Freq to a value greater than the Stop Freq – 10 Hz. If you are already</p>

	in zero span, you cannot increment at all, and the first decrement will be forced to at least 10 Hz.
Couplings	<p>If you change the start frequency of the selected range to a value &lt; the previous range's stop frequency (where the previous range is turned on), the stop frequency of the previous range will be changed to the same value.</p> <p>If you change the start frequency &lt;=min frequency of the instrument, the start frequency of the selected range will be set to the minimum frequency of the analyzer, and all the previous ranges before the selected range will be turned off.</p> <p>If you change the start frequency &gt;=maximum frequency of the instrument, the start frequency of the selected range will be set to the maximum frequency of the instrument -10 Hz; while the stop frequency of selected range will be set to the maximum frequency of the instrument. All subsequent ranges after the selected range will be turned off.</p>
Preset	9 kHz 150 kHz 30 MHz 300 MHz 30 MHz 1 GHz 1 GHz 1.0001 GHz 1.0002 GHz 1.0003 GHz
State Saved	Saved in instrument state.
Min	If the knob or step keys are being used, depends on the value of the other three interdependent parameters
Max	Depends on the instrument maximum frequency - 10 Hz minimum span. If the knob or step keys are being used, it depends on the value of the other three interdependent parameters
Default Unit	Hz
<b>Backwards Compatibility SCPI</b>	:SENSe1 SENSe2:SCAN[1] 2 ... 10:START [:SENSe]:SCAN[1] 2 ... 10:START
Backwards Compatibility SCPI Notes	This command above is included for ESU compatibility. The suffix 1 2 is irrelevant to the measurement, they are added solely for remote language compatibility.
Initial S/W Revision	A.07.00

## Stop Freq

Specifies the stop frequency of the selected range.

Key Path	Meas Setup, Scan Table
Remote Command	[:SENSe]:FSCan:SCAN[1] 2 ... 10:STOP <freq> [:SENSe]:FSCan:SCAN[1] 2 ... 10:STOP?
Example	FSC:SCAN:STOP 150e3 Set stop freq of Range 1 to 150 kHz. FSC:SCAN:STOP?
Notes	Max values depend on Hardware Options (503, 507, 508, 513, 526)
Dependencies	<p>This key is grayed out during multi range scanning. If the grayed out key is pressed, an advisory message is generated. If the equivalent SCPI command is sent, this same message is generated as part of a "-221, Settings conflict; Function not available while running multirange scan" warning.</p> <p>This key is grayed out during final measurement. If the grayed out key is pressed, an advisory message is generated. If the equivalent SCPI command is sent, this same message is generated as part of a "-221, Settings conflict" warning.</p> <p>By direct entry: You cannot set the Stop frequency &lt; the Start frequency. You cannot set the Start frequency = the</p>

	<p>Stop frequency. You cannot select zero span by setting Start = Stop. You cannot set the Stop Frequency to a value that would create a span of less than 10 Hz. If you try to do any of these, the Start Frequency will change to maintain a minimum value of 10 Hz for the difference between the Start and Stop.</p> <p>With the knob or step keys: You cannot decrement the Stop Freq to a value less than the Start Freq + 10 Hz. If already in zero span, you cannot decrement at all, and the first increment will be forced to at least 10 Hz.</p>
Couplings	<p>If you change the stop frequency of the selected range to a value &gt; the next range's start frequency (where the next range is turned on), the start frequency of the next range will be changed to the same value.</p> <p>If you change the stop frequency &gt;=the maximum frequency of the instrument, the stop frequency of the selected range will be set to the maximum frequency of the instrument, and all the subsequent ranges after the selected range will be turned off.</p> <p>If you change the stop frequency &lt;=the minimum frequency of the instrument, the stop frequency of the selected range will be set to the minimum frequency of the instrument + 10 Hz; while the start frequency of the selected range will be set to the minimum frequency of the instrument, and all the previous ranges before the selected range will be turned off.</p>
Preset	The stop frequency of Range 6 is depends on the maximum frequency, with a maximum of 18 GHz.
State Saved	Saved in instrument state.
Min	-79.999990 MHz If the knob or step keys are being used, depends on the value of the other three interdependent parameters
Max	Depends on the instrument maximum frequency. If the knob or step keys are being used, depends on the value of the other three interdependent parameters
Default Unit	Hz
<b>Backwards Compatibility SCPI</b>	<code>:SENSe1   SENSe2:SCAN[1]   2   ...   10:STOP</code> <code>[ :SENSe ] :SCAN[1]   2   ...   10:STOP</code>
Backwards Compatibility SCPI Notes	This command above is included for ESU compatibility. The suffix 1 2 is irrelevant to the measurement, they are added solely for remote language compatibility.
Initial S/W Revision	A.07.00

## Res BW

Specifies the Res BW of the selected range.

Key Path	Meas Setup, Scan Table
<b>Remote Command</b>	<code>[ :SENSe ] :FSCan:SCAN[1]   2   ...   10:BANDwidth[:RESolution] &lt;freq&gt;</code> <code>[ :SENSe ] :FSCan:SCAN[1]   2   ...   10:BANDwidth[:RESolution] ?</code> <code>[ :SENSe ] :FSCan:SCAN[1]   2   ...   10:BANDwidth[:RESolution]:AUTO ON   OFF   1   0</code> <code>[ :SENSe ] :FSCan:SCAN[1]   2   ...   10:BANDwidth[:RESolution]:AUTO?</code>
<b>Example</b>	FSC:SCAN8:BAND 8e6 Set Res BW of Range 8 to 8 MHz.

	FSC:SCAN8:BAND? FSC:SCAN4:BAND:AUTO 1 ! Turn on Auto Res BW for Range 4. FSC:SCAN4:BAND:AUTO?
Notes	For numeric entries, the RBW chooses the nearest (arithmetically, on a linear scale, rounding up) available RBW to the value entered.
Notes	You are not allowed to select between Auto/ Man RBW in ESU. This key is grayed out when a scan sequence is running except during single range scanning. If the grayed out key is pressed, an advisory message is generated. If the equivalent SCPI command is sent, this same message is generated as part of a “-221, Settings conflict” warning.
Dependencies	This key is grayed out during multi range scanning. If the grayed out key is pressed, an advisory message is generated. If the equivalent SCPI command is sent, this same message is generated as part of a “-221, Settings conflict; Function not available while running multirange scan” warning. This key is grayed out during final measurement. If the grayed out key is pressed, an advisory message is generated. If the equivalent SCPI command is sent, this same message is generated as part of a “-221, Settings conflict” warning. If the combination of the selected RBW and the Points/RBW results in the number of required scan points that is larger than the maximum supported value, the Stop Frequency will be clipped with a “-221, Settings conflict” warning.
Couplings	When a CISPR or MIL EMI Standard is in use, the Res BW is coupled to the Center Frequency and not to Span, and this is true even in Zero Span.
Preset	200 Hz 9.1 kHz 120 kHz 120kHz 120 kHz 1 MHz 1 MHz 1 MHz 1 MHz 1 MHz ON
State Saved	Saved in instrument state.
Min	10 Hz is the minimum value for Time Domain scan.
Max	8 MHz is the maximum equivalent -3 dB RBW, which means that the named RBW (the one shown on the key etc.) can actually exceed 8 MHz if using a filter type other than -3dB. The maximum value for Time Domain scan is 3 MHz.
Default Unit	Hz
<b>Backwards Compatibility SCPI</b>	:SENSe1 SENSe2:SCAN[1] 2 ... 10:BANDwidth[:RESolution] [:SENSe]:SCAN[1] 2 ... 10:BANDwidth[:RESolution]
Backwards Compatibility SCPI Notes	This command above is included for ESU compatibility. The suffix 1 2 is irrelevant to the measurement, they are added solely for remote language compatibility.
Initial S/W Revision	A.07.00

## Display Scan Table

Turns on and off the scan table editor. Once you turn off the scan table display, it will stay off even when you press the Scan table key.

Key Path	Meas Setup, Scan Table
Remote Command	:CALCulate:FSCan:SCAN:DISPlay G1 G2 OFF :CALCulate:FSCan:SCAN:DISPlay?



<b>Example</b>	CALC:FSC:SCAN:DISP OFF Turn off scan table editor. CALC:FSC:SCAN:DISP?
Preset	G1
State Saved	Saved in instrument state.
Range	G1 G2 OFF
Initial S/W Revision	A.07.00

## Dwell Time

Specifies the dwell time for each step size defined in the selected range.

<b>Key Path</b>	Meas Setup, Scan Table															
<b>Remote Command</b>	[ :SENSe ] :FSCan:SCAN[1]  2 ... 10:TIME <time> [ :SENSe ] :FSCan:SCAN[1]  2 ... 10:TIME? [ :SENSe ] :FSCan:SCAN[1]  2 ... 10:TIME:AUTO ON OFF 1 0 [ :SENSe ] :FSCan:SCAN[1]  2 ... 10:TIME:AUTO?															
<b>Example</b>	FSC:SCAN7:TIME 0.5 Set the dwell time of Range 7. FSC:SCAN7:TIME? FSC:SCAN:TIME:AUTO ON ! Turn on Auto Dwell Time in Range 1. FSC:SCAN:TIME:AUTO?															
<b>Dependencies</b>	<p>This key is grayed out when the Step Control is set to “Scan Time &amp; Points”. If the grayed out key is pressed, an advisory message is generated. If the equivalent SCPI command is sent, this same message is generated as part of a “-221, Settings conflict; Function not available while running multirange scan” warning.</p> <p>This key is grayed out during multi range scanning. If the grayed out key is pressed, an advisory message is generated. If the equivalent SCPI command is sent, this same message is generated as part of a “-221, Settings conflict; Function not available while running multirange scan” warning.</p> <p>This key is grayed out during final measurement. If the grayed out key is pressed, an advisory message is generated. If the equivalent SCPI command is sent, this same message is generated as part of a “-221, Settings conflict” warning.</p> <p>When in Discrete (Stepped) Scan, there is no Auto setting for measurement time. The Auto/Man line on the Dwell Time softkey disappears in this case, and if the SCPI command [ :SENSe ] :SCAN[1]  2 3 4 5 6 7 8 9 10:TIME:AUTO ON is sent, it generates an error.</p> <p>In Time Domain Scan, the dwell times are based on the following table:</p> <table border="1"> <tr> <td>10 Hz</td> <td>100 s</td> <td>10 ms</td> </tr> <tr> <td>100 Hz</td> <td>100 s</td> <td>1 ms</td> </tr> <tr> <td>200 Hz</td> <td>100 s</td> <td>1 ms</td> </tr> <tr> <td>1 kHz</td> <td>100 s</td> <td>100 us</td> </tr> <tr> <td>9 kHz</td> <td>100 s</td> <td>100 us</td> </tr> </table>	10 Hz	100 s	10 ms	100 Hz	100 s	1 ms	200 Hz	100 s	1 ms	1 kHz	100 s	100 us	9 kHz	100 s	100 us
10 Hz	100 s	10 ms														
100 Hz	100 s	1 ms														
200 Hz	100 s	1 ms														
1 kHz	100 s	100 us														
9 kHz	100 s	100 us														

	10 kHz	100 s	100 us
	100 kHz	30 s	10 us
	120 kHz	30 s	10 us
	1 MHz	3 s	10 us
Couplings	<p>When you change the value of the dwell time, the scan time of the selected range will be changed accordingly, based on the calculation <math>\text{Scan Time} = \text{Dwell Time} \times (\text{ScanPoints} - 1)</math>.</p> <p>The Dwell Time Auto selection is only available when in Smooth Scan. In Dwell Time Auto, dwell time will be set according to the SA- Normal sweep time rules for the active trace detector.</p> <p>If the calculated auto dwell time is greater than the maximum dwell time, a warning message "Setting Alert; Sweep Rate Unavailable" is displayed, and the dwell time will be set to the maximum value; if the dwell time is set to a value less than the calculated auto dwell time, a warning message "Meas Uncal" is displayed.</p> <p>Auto Dwell Time and Auto Scan Time are always coupled.</p>		
Preset	<p>4.102 ms 108.067 us 6.733 us 6.733 us 6.733 us 1.267 us 1.000 ms 1.000 ms 1.000 ms 1.000 ms</p> <p>ON</p>		
State Saved	Saved in instrument state.		
Min	The allowable min value is dependent on Range Span and Scan Points.		
Max	<p>The Max value depends on the Scan Type and Step Size of the selected range.</p> <p>When in Smooth (Swept) Scan, the max value depends on the number of Scan Points, where the latter is determined by Step Size: <math>\text{Max Dwell time} = \text{Max Scan Time} / (\text{Scan Points} - 1)</math>. The Max Scan Time is 4000 sec.</p> <p>When in Discrete (Stepped) Scan, the max value is fixed to 100 s.</p>		
Default Unit	s		
<b>Backwards Compatibility SCPI</b>	<pre>:SENSe1 SENSe2:SCAN[1] 2 ... 10:TIME</pre> <pre>[ :SENSe ] :SCAN [ 1 ]   2   . . .   10 : TIME</pre>		
Backwards Compatibility SCPI Notes	This command above is included for ESU compatibility. The suffix 1 2 is irrelevant to the measurement, they are added solely for remote language compatibility.		
Initial S/W Revision	A.07.00		

## Step Size

Specifies the Step Size of the selected range.

Key Path	Meas Setup, Scan Table
Remote Command	<pre>[ :SENSe ] :FSCan:SCAN[1] 2 ... 10:STEP &lt;freq&gt;</pre> <pre>[ :SENSe ] :FSCan:SCAN[1] 2 ... 10:STEP?</pre> <pre>[ :SENSe ] :FSCan:SCAN[1] 2 ... 10:STEP:AUTO ON OFF 1 0</pre> <pre>[ :SENSe ] :FSCan:SCAN[1] 2 ... 10:STEP:AUTO?</pre>

<b>Example</b>	<p>FSC:SCAN2:STEP 100kHz Set the step size of Range 2 to 100 kHz.          FSC:SCAN2:STEP?          FSC:SCAN3:STEP:AUTO 1 ! Turn on Auto Step Size in range 3.          FSC:SCAN3:STEP:AUTO?</p>
<b>Notes</b>	<p>When set to auto, the selected Auto Step Size Rules will be used to calculate the step size.</p> <p>Points/ RBW</p> <p>Scan point is calculated based on the number of points for each RBW width, the smallest odd number <math>\geq</math> Number of Points*(Stop Frequency-Start Frequency)/RBW will be used as the scan points. The step size is then calculated based on scan point, using the formula Step Size = (Stop Frequency-Start Frequency)/Scan Point-1.</p> <p>Log % of Freq</p> <p>Step Size is calculated based on the Log % of Freq of the current frequency. E.g. Range Start = 10 MHz, Range Stop= 20 MHz, Log % of Freq = 10. The frequency will step in the following step size:</p> <p>1 MHz          1.1 MHz          1.21 MHz          1.331 MHz          1.4641 MHz          1.61051 MHz          1.771561 MHz          1.9487171 MHz          2.14358881 MHz</p> <p>The first step size will be shown on the Step Size key, where in the example above, the value 1 will be shown. Please take note that Log % of Freq is only available during the Discrete (Stepped) scan.</p>
<b>Dependencies</b>	<p>This key is grayed out when the Step Control is set to "Scan Time &amp; Points". If the grayed out key is pressed, an advisory message is generated. If the equivalent SCPI command is sent, this same message is generated as part of a "-221, Settings conflict; Function not available while running multirange scan" warning.</p> <p>This key is grayed out during multi range scanning. If the grayed out key is pressed, an advisory message is generated. If the equivalent SCPI command is sent, this same message is generated as part of a "-221, Settings conflict; Function not available while running multirange scan" warning.</p> <p>This key is grayed out during final measurement. If the grayed out key is pressed, an advisory message is generated. If the equivalent SCPI command is sent, this same message is generated as part of a "-221, Settings conflict" warning.</p> <p>This key is grayed out during a Time Domain Scan. If the grayed out key is pressed, an advisory message is generated. If the equivalent SCPI command is sent, this same message is generated as part of a "-221, Settings conflict; Function not available with time domain scan type" warning.</p>
<b>Couplings</b>	<p>For numeric entries in Smooth Scan, the step size chooses the nearest step size based on the Sweep Point converted from the step size, where Sweep Point = (Stop Frequency-Start Frequency)/Step Size. The Sweep Point will be rounded to the nearest integer and the actual step size will be calculated using (Stop Frequency-Start Frequency)/Sweep Point. A message is generated as part of a "-221, Settings conflict" warning.</p> <p>For numeric entries in Time Domain Scan, the step size chooses the nearest step size based on the RBW/Step Size ratio, which must be 4.</p>

	<p>No rules for entries during Discrete (Stepped) Scan.</p> <p>If user changes the step size to a value that causing the total range point to exceed 40001, range state of the specific range will be changed to off. An advisory message is generated. If the equivalent SCPI command is sent, this same message is generated as part of a “-221, Settings conflict” warning.</p> <p>Auto Step Size and Auto Scan Points is always coupled.</p>
Preset	100 Hz 4.5 kHz 60 kHz 60.003 kHz 60.003 kHz 500kHz 100 kHz 100 kHz 100 kHz 100 kHz ON
State Saved	Saved in instrument state.
Min	The minimum step size will be limited to a value where the number of points for a range cannot be more than 40001.
Max	<p>Depends on the maximum range of the selected range, but the value is limited by the Max frequency of the instrument.</p> <p>Option 503 (3 GHz models): 3.08 GHz  Option 503 (3.6 GHz models): 3.7 GHz  Option 507 (7 GHz models): 7.1 GHz  Option 507 (7.5 GHz models): 7.58 GHz  Option 508: 8.5 GHz  Option 513: 13.8 GHz  Option 526: 27.0 GHz</p>
Default Unit	Hz
<b>Backwards Compatibility SCPI</b>	<pre>:SENSe1 SENSe2:SCAN[1] 2 ... 10:STEP [:SENSe]:SCAN[1] 2 ... 10:STEP</pre>
Backwards Compatibility SCPI Notes	This command above is included for ESU compatibility. The suffix 1 2 is irrelevant to the measurement, they are added solely for remote language compatibility.
Initial S/W Revision	A.07.00

## Scan Time

Specifies the scan time of the selected range.

Key Path	Meas Setup, Scan Table
<b>Remote Command</b>	<pre>[:SENSe]:FSCan:SCAN[1] 2 ... 10:STIME &lt;time&gt; [:SENSe]:FSCan:SCAN[1] 2 ... 10:STIME? [:SENSe]:FSCan:SCAN[1] 2 ... 10:STIME:AUTO ON OFF 1 0 [:SENSe]:FSCan:SCAN[1] 2 ... 10:STIME:AUTO?</pre>
<b>Example</b>	<pre>FSC:SCAN7:STIM 0.5 Set the dwell time of Range 7. FSC:SCAN7:STIM? FSC:SCAN:STIM:AUTO ON ! Turn on Auto Scan Time in Range 1. FSC:SCAN:STIM:AUTO?</pre>

Dependencies	<p>This key is grayed out when the Step Control is set to “Step Size &amp; Dwell Time”. If the grayed out key is pressed, an advisory message is generated. If the equivalent SCPI command is sent, this same message is generated as part of a “-221, Settings conflict; Function not available while running multirange scan” warning.</p> <p>This key is grayed out during multi range scanning. If the grayed out key is pressed, an advisory message is generated. If the equivalent SCPI command is sent, this same message is generated as part of a “-221, Settings conflict; Function not available while running multirange scan” warning.</p> <p>This key is grayed out during final measurement. If the grayed out key is pressed, an advisory message is generated. If the equivalent SCPI command is sent, this same message is generated as part of a “-221, Settings conflict” warning.</p> <p>This key is grayed out during a Time Domain Scan. If the grayed out key is pressed, an advisory message is generated. If the equivalent SCPI command is sent, this same message is generated as part of a “-221, Settings conflict; Function not available with time domain scan type” warning.</p> <p>When in the Discrete (Stepped) and Time Domain Scan, there is no Auto setting for the scan time. The Auto/Man line on the Dwell Time softkey disappears in this case, and if the SCPI command [:SENSe]:SCAN[1] 2 3 4 5 6 7 8 9 10:TIME:AUTO ON is sent, it generates an error.</p>
Couplings	<p>When you change the value of the scan time, the dwell time of the selected range will be changed accordingly, based on the calculation dwell time = scan time / (scan points-1).</p> <p>The Scan Time Auto selection is only available when in Smooth Scan. In Scan Time Auto, the scan time will be set according to the SA- Normal sweep time rules for the active non EMI trace detector. However, the EMI trace detector will have different sweep time rules.</p> <p>If the calculated auto scan time is greater than the maximum scan time, a warning message “Setting Alert; Sweep Rate Unavailable” is displayed, and the scan time will be set to the maximum value; if the scan time is set to a value less than the calculated auto sweep time, a warning message “Meas Uncal” is displayed.</p> <p>Auto Scan Time and Auto Dwell Time are always coupled.</p>
Preset	<p>5.784 s 716.914 ms 30.300 ms 78.551 ms 108.851 ms 43.067 ms 1.000 ms 1.000 ms 1.000 ms 1.000 ms</p> <p>ON</p>
State Saved	Saved in instrument state.
Min	The allowable min value is dependent on Range Span and Scan Points.
Max	<p>4 ks when Scan Type = Smooth</p> <p>4 Ms when Scan Type = Discrete</p>
Default Unit	s
Initial S/W Revision	A.07.00

## Scan Points

Specifies the Scan Points of the selected range.

Key Path	Meas Setup, Scan Table
Remote Command	<pre>[:SENSe]:FSCan:SCAN[1] 2 ... 10:POINTs &lt;integer&gt;</pre> <pre>[:SENSe]:FSCan:SCAN[1] 2 ... 10:POINTs ?</pre>

	[:SENSe]:FSCan:SCAN[1] 2 ... 10:POINTs:AUTO ON OFF 1 0 [:SENSe]:FSCan:SCAN[1] 2 ... 10:POINTs:AUTO?
<b>Example</b>	FSC:SCAN2:POIN 200 Set Range 2 to have 200 points. FSC:SCAN2:POIN? FSC:SCAN3:POIN:AUTO 1 ! Turn on Auto Scan Points in range 3. FSC:SCAN3:POIN:AUTO?
<b>Notes</b>	When set to auto, the selected Auto Step Size Rules will be used to calculate the scan points. Points/ RBW The Scan point is calculated based on the number of points for each RBW width, the smallest odd number $\geq$ Number of Points*(Stop Frequency-Start Frequency)/RBW will be used as the scan points. Log % of Freq The Step Size is calculated based on the Log % of Freq of the current frequency. The Scan Points will be calculated based on the step size.
<b>Dependencies</b>	This key is grayed out when the Step Control is set to "Step Size & Dwell Time". If the grayed out key is pressed, an advisory message is generated. If the equivalent SCPI command is sent, this same message is generated as part of a "-221, Settings conflict; Function not available while running multirange scan" warning. This key is grayed out during multi range scanning. If the grayed out key is pressed, an advisory message is generated. If the equivalent SCPI command is sent, this same message is generated as part of a "-221, Settings conflict; Function not available while running multirange scan" warning. This key is grayed out during final measurement. If the grayed out key is pressed, an advisory message is generated. If the equivalent SCPI command is sent, this same message is generated as part of a "-221, Settings conflict" warning. This key is grayed out during a Time Domain Scan. If the grayed out key is pressed, an advisory message is generated. If the equivalent SCPI command is sent, this same message is generated as part of a "-221, Settings conflict; Function not available with time domain scan type" warning.
<b>Couplings</b>	If you change the step size to a value that causes the total range point to exceed 40001 the range state of the specific range will be changed to off. An advisory message is generated. If the equivalent SCPI command is sent, this same message is generated as part of a "-221, Settings conflict" warning. The value of Step Size and Scan Points are always coupled. Auto Scan Points and Auto Step Size are always coupled.
<b>Preset</b>	The scan point of Range 6 depends on the maximum frequency, with a maximum of 34001 points.
<b>State Saved</b>	Saved in instrument state.
<b>Min</b>	2
<b>Max</b>	40001
<b>Default Unit</b>	Enter
<b>Initial S/W Revision</b>	A.07.00

## Auto Step Size Rules

Specifies the Auto Step Size Rules of the selected range.

Key Path	Meas Setup, Scan Table
Remote Command	[ :SENSe ] :FSCan:SCAN [1]  2 ... 10:RULes PRBW LPCT [ :SENSe ] :FSCan:SCAN [1]  2 ... 10:RULes?
Example	FSC:SCAN3:RUL LPCT Set Range 3 to use auto rules of Log % of Freq FSC:SCAN3:RUL?
Dependencies	This key is grayed out during multi range scanning. If the grayed out key is pressed, an advisory message is generated. If the equivalent SCPI command is sent, this same message is generated as part of a “-221, Settings conflict; Function not available while running multirange scan” warning. This key is grayed out during final measurement. If the grayed out key is pressed, an advisory message is generated. If the equivalent SCPI command is sent, this same message is generated as part of a “-221, Settings conflict” warning.
Couplings	Changing Auto Step Size Rules will automatically change the step size of the selected range to Auto.
Preset	PRBW
State Saved	Saved in instrument state.
Range	Points/RBW   Log % of Freq
Readback	If Auto Step Size Rules is Points/RBW, [Points/RBW,<int>] If Auto Step Size Rules is Log % of Freq, [Log %,<int>]
Initial S/W Revision	A.07.00

### Points/ RBW

Choose the Step Size to change automatically based on number of Points/ RBW

Key Path	Meas Setup, Scan Table, Auto Step Size Rules
Example	FSC:SCAN:RUL PRBW Selects the Points/RBW Auto Step Rules for range 1.
Couplings	Selecting the points/RBW will cause the step size of the selected range to turn into Auto, even if it was already selected.
Initial S/W Revision	A.07.00

Specifies the value of Point/ RBW for the selected Range.

Key Path	Meas Setup, Scan Table, Auto Step Size Rules
Remote Command	[ :SENSe ] :FSCan:SCAN [1]  2 ... 10:PRBW <integer> [ :SENSe ] :FSCan:SCAN [1]  2 ... 10:PRBW?
Example	FSC:SCAN2:PRBW 2 Set 2 points/ RBW for Range 2. FSC:SCAN2:PRBW?
Dependencies	This key is grayed out during multi range scanning. If the grayed out key is pressed, an advisory message is generated. If the equivalent SCPI command is sent, this same message is generated as part of a “-221, Settings conflict; Function not available while running multirange scan” warning. This key is grayed out during final measurement. If the grayed out key is pressed, an advisory

	<p>message is generated. If the equivalent SCPI command is sent, this same message is generated as part of a “-221, Settings conflict” warning.</p> <p>This key is grayed out during Time Domain Scan. If the grayed out key is pressed, an advisory message is generated. If the equivalent SCPI command is sent, this same message is generated as part of a “-221, Settings conflict; Function not available with time domain scan type” warning. During Time Domain Scan, the value is automatically set to 4. Changing to another Scan Type from Time Domain to another scan type does not restore the previous value.</p>
Preset	2
State Saved	Saved in instrument state.
Min	1
Max	4
Initial S/W Revision	A.07.00

### Log % of Freq

Choose the Step Size to change automatically incremented in % of the current frequency.

Key Path	Meas Setup, Scan Table, Auto Step Size Rules
<b>Example</b>	FSC:SCAN:RUL LPCT Selects the Points/RBW Auto Step Rules for range 1.
Dependencies	This key is grayed out when the Scan type is set to Smooth and Time Domain. If the grayed out key is pressed, an advisory message is generated. If the equivalent SCPI command is sent, this same message is generated as part of a “-221, Settings conflict” warning.
Couplings	Selecting the Log % of Freq will cause the step size of the selected range to turn into Auto, even if it was already selected.
Initial S/W Revision	A.07.00

Key Path	Meas Setup, Scan Table, Step Control, Auto Step Size Rules
<b>Remote Command</b>	[ :SENSe ] :FSCan :SCAN [ 1 ]   2   . . .   10 :LPCT <integer> [ :SENSe ] :FSCan :SCAN [ 1 ]   2   . . .   10 :LPCT ?
<b>Example</b>	FSC:SCAN2:LPCT 2 Set the Range 3 to make log scan using 2% of current frequency. FSC:SCAN2:LPCT?
Dependencies	<p>This key is grayed out when the Scan type is set to Smooth and Time Domain. If the grayed out key is pressed, an advisory message is generated. If the equivalent SCPI command is sent, this same message is generated as part of a “-221, Settings conflict” warning.</p> <p>This key is grayed out during multi range scanning. If the grayed out key is pressed, an advisory message is generated. If the equivalent SCPI command is sent, this same message is generated as part of a “-221, Settings conflict; Function not available while running multirange scan” warning.</p> <p>This key is grayed out during final measurement. If the grayed out key is pressed, an advisory message is generated. If the equivalent SCPI command is sent, this same message is generated as part of a “-221, Settings conflict” warning.</p>



Preset	10
State Saved	Saved in instrument state.
Min	0.1
Max	100
Initial S/W Revision	A.07.00

## Attenuation

Specifies the attenuation of the selected range. Only the mechanical attenuator is available in the Frequency Scan measurement.

Key Path	Meas Setup, Scan Table
<b>Remote Command</b>	<code>[ :SENSe ] :FSCan:SCAN[1]   2   ...   10 :INPut:ATTenuation &lt;rel_ampl&gt;</code> <code>[ :SENSe ] :FSCan:SCAN[1]   2   ...   10 :INPut:ATTenuation?</code>
<b>Example</b>	FSC:SCAN2:INP:ATT 30 Set attenuation of Range 2 to 30dB. FSC:SCAN2:INP:ATT?
Dependencies	This key is grayed out during multi range scanning. If the grayed out key is pressed, an advisory message is generated. If the equivalent SCPI command is sent, this same message is generated as part of a “-221, Settings conflict; Function not available while running multirange scan” warning. This key is grayed out during final measurement. If the grayed out key is pressed, an advisory message is generated. If the equivalent SCPI command is sent, this same message is generated as part of a “-221, Settings conflict” warning.
Preset	10dB
State Saved	Saved in instrument state.
Min	0 dB
Max	50 dB (CXA) 60 dB (EXA) 70 dB (MXA, PXA)
<b>Backwards Compatibility SCPI</b>	<code>:SENSe1   SENSe2 :SCAN[1]   2   ...   10 :INPut:ATTenuation</code> <code>[ :SENSe ] :SCAN[1]   2   ...   10 :INPut:ATTenuation</code>
Backwards Compatibility SCPI Notes	This command above is included for ESU compatibility. The suffix 1 2 is irrelevant to the measurement, they are added solely for remote language compatibility.
Initial S/W Revision	A.07.00

## Int Preamp

Specifies the Internal Preamp state of the selected range.

Key Path	Meas Setup, Scan Table
<b>Remote Command</b>	<code>[ :SENSe ] :FSCan:SCAN[1]   2   ...   10 :POWer:GAIN[:STATE] ON   OFF   1   0</code>

	<code>[ :SENSe ] :FSCan :SCAN [ 1 ]   2   . . .   10 :POWer :GAIN [ :STATe ] ?</code>
<b>Example</b>	FSC:SCAN4:POW:GAIN ON Turn on Internal Preamp of Range 4. FSC:SCAN4:POW:GAIN?
Dependencies	Preamp is not available on all hardware platforms. If the preamp is not present or is unlicensed, the key is not shown.  This key is grayed out during multi range scanning. If the grayed out key is pressed, an advisory message is generated. If the equivalent SCPI command is sent, this same message is generated as part of a “-221, Settings conflict; Function not available while running multirange scan” warning.  This key is grayed out during final measurement. If the grayed out key is pressed, an advisory message is generated. If the equivalent SCPI command is sent, this same message is generated as part of a “-221, Settings conflict” warning.
Preset	OFF
State Saved	Saved in instrument state.
Range	On Off
Initial S/W Revision	A.07.00
<b>Key Path</b>	Meas Setup, Scan Table
<b>Remote Command</b>	<code>[ :SENSe ] :FSCan :SCAN [ 1 ]   2   . . .   10 :POWer :GAIN :BAND LOW   FULL</code> <code>[ :SENSe ] :FSCan :SCAN [ 1 ]   2   . . .   10 :POWer :GAIN :BAND ?</code>
<b>Example</b>	FSC:SCAN3:POW:GAIN:BAND LOW Set Range 3 to Low band Preamp. FSC:SCAN3:POW:GAIN:BAND?
Dependencies	Preamp is not available on all hardware platforms. If the preamp is not present or is unlicensed, the key is not shown.  If a POW:GAIN:BAND FULL command is sent when a low band preamp is available, the preamp band parameter is set to LOW instead of FULL, and an “Option not installed” message is generated.  This key is grayed out during multi range scanning. If the grayed out key is pressed, an advisory message is generated. If the equivalent SCPI command is sent, this same message is generated as part of a “-221, Settings conflict; Function not available while running multirange scan” warning.  This key is grayed out during final measurement. If the grayed out key is pressed, an advisory message is generated. If the equivalent SCPI command is sent, this same message is generated as part of a “-221, Settings conflict” warning.
Preset	LOW
State Saved	Saved in instrument state.
Range	Low Band Full Range
Initial S/W Revision	A.07.00
<b>Remote Command</b>	<code>[ :SENSe ] :SCAN [ 1 ]   2   . . .   10 :INPut :GAIN [ :STATe ] ON   OFF   1   0</code> <code>[ :SENSe ] :SCAN [ 1 ]   2   . . .   10 :INPut :GAIN [ :STATe ] ?</code>
<b>Example</b>	SCAN5:INP:GAIN ON Turn on low band preamp in Range 5.

	SCAN5:INP:GAIN?
Notes	This command is included for ESU compatibility. The suffix [1]2 of SENSE node is irrelevant to the measurement, they are added solely for remote language compatibility. ON is aliased to :SCAN:POW:GAIN ON; :SCAN:POW:GAIN:BAND LOW for the selected range. OFF is aliased to :SCAN:POW:GAIN OFF for the selected range.
Dependencies	This key is grayed out when a scan sequence is running except during single range scanning. If the grayed out key is pressed, an advisory message is generated. If the equivalent SCPI command is sent, this same message is generated as part of a “-221, Settings conflict” warning.
Preset	OFF
State Saved	Saved in instrument state.
<b>Backwards Compatibility SCPI</b>	:SENSe1   SENSe2:SCAN [1]   2   ...   10:INPut:GAIN[:STATe]
Initial S/W Revision	A.07.00

## Autorange

When autorange is set to on, the attenuation will be increased automatically when an overload is detected during a scan.

Key Path	Meas Setup, Scan Table
<b>Remote Command</b>	[ :SENSe ] :FSCan:SCAN [1]   2   ...   10:INPut:ATTenuation:AUTO ON   OFF   1   0 [ :SENSe ] :FSCan:SCAN [1]   2   ...   10:INPut:ATTenuation:AUTO
<b>Example</b>	:FSC:SCAN8:INP:ATT:AUTO 1 Turn on Auto range for Range 8 :FSC:SCAN8:INP:ATT:AUTO?
Dependencies	This key is grayed out when a scan sequence is running. If the grayed out key is pressed, an advisory message is generated. If the equivalent SCPI command is sent, this same message is generated as part of a “-221, Settings conflict” warning.
Preset	OFF
State Saved	Saved in instrument state.
<b>Backwards Compatibility SCPI</b>	:SENSe1   SENSe2:SCAN [1]   2   ...   10:INPut:ATTenuation:AUTO [ :SENSe ] :SCAN [1]   2   ...   10:INPut:ATTenuation:AUTO
Backwards Compatibility SCPI Notes	This command above is included for ESU compatibility. The suffix [1]2 and [1]2...10 are irrelevant to the measurement, they are added solely for remote language compatibility.
Initial S/W Revision	A.07.00

## Auto Preamp

When on, the Int Premp will be considered in the autorange procedure when performing a scan.

Key Path	Meas Setup, Scan Table
----------	------------------------

<b>Remote Command</b>	<code>[ :SENSe ] :FSCan :SCAN [ 1 ]   2   . . .   10 :POWer :GAIN :AUTO ON   OFF   1   0</code> <code>[ :SENSe ] :FSCan :SCAN [ 1 ]   2   . . .   10 :POWer :GAIN :AUTO ?</code>
<b>Example</b>	<code>FSC:SCAN4:POW:GAIN:AUTO ON</code> Turn on Auto preamp for Range 4 <code>FSC:SCAN4:POW:GAIN:AUTO?</code>
<b>Dependencies</b>	This key is grayed out when a scan sequence is running. If the grayed out key is pressed, an advisory message is generated. If the equivalent SCPI command is sent, this same message is generated as part of a “-221, Settings conflict” warning.
<b>Preset</b>	OFF
<b>State Saved</b>	Saved in instrument state.
<b>Backwards Compatibility SCPI</b>	<code>:SENSe1   SENSe2 :SCAN [ 1 ]   2   . . .   10 :INPut :GAIN :AUTO</code> <code>[ :SENSe ] :SCAN [ 1 ]   2   . . .   10 :INPut :GAIN :AUTO</code>
<b>Backwards Compatibility SCPI Notes</b>	This command above is included for ESU compatibility. The suffix [1]2 and [1]2 ... 10 are irrelevant to the measurement, they are added solely for remote language compatibility.
<b>Initial S/W Revision</b>	A.07.00

## RF Input Port

Selects the RF Input of the selected range.

<b>Key Path</b>	Meas Setup, Scan Table
<b>Remote Command</b>	<code>[ :SENSe ] :FSCan :SCAN [ 1 ]   2   . . .   10 :FEED :RF :PORT [ :INPut ] RFIN   RFIN2</code> <code>[ :SENSe ] :FSCan :SCAN [ 1 ]   2   . . .   10 :FEED :RF :PORT [ :INPut ] ?</code>
<b>Example</b>	<code>:FSC:SCAN3:FEED:RF:PORT INP2</code> Set Range 3 to use RF Input port2. <code>:FSC:SCAN3:FEED:RF:PORT?</code>
<b>Dependencies</b>	This key is available only when the measurement is running on a N9038A. This key is grayed out during multi range scanning. If the grayed out key is pressed, an advisory message is generated. If the equivalent SCPI command is sent, this same message is generated as part of a “-221, Settings conflict; Function not available while running multirange scan” warning. This key is grayed out during final measurement. If the grayed out key is pressed, an advisory message is generated. If the equivalent SCPI command is sent, this same message is generated as part of a “-221, Settings conflict” warning.
<b>Preset</b>	RFIN
<b>State Saved</b>	Saved in instrument state.
<b>Range</b>	RF Input RF Input 2
<b>Initial S/W Revision</b>	A.07.00

<b>Remote Command</b>	<code>:SENSe1   SENSe2 :SCAN [ 1 ]   2   . . .   10 :INPut :TYPE INPUT1   INPUT2</code> <code>[ :SENSe ] :SCAN [ 1 ]   2   . . .   10 :INPut :TYPE</code> <code>:SENSe1   SENSe2 :SCAN [ 1 ]   2   . . .   10 :INPut :TYPE ?</code>
-----------------------	---

	<code>[ :SENSE ] :SCAN [ 1 ]   2   . . .   10 :INPut :TYPE ?</code>
<b>Example</b>	SCAN2:INP:TYPE INPUT1
Notes	This command above is included for ESU compatibility. The suffix [1]2 is irrelevant to the measurement, they are added solely for remote language compatibility.

## Range → SA

This key will propagate the setting of the currently selected range to the Swept SA measurement in the Spectrum Analyzer Mode. This functionality will enable you to use the continuous sweep capabilities that are not available in the Frequency Scan measurement. The affected settings are:

- Start Frequency
- Stop Frequency
- RBW
- Sweep Point, which will be converted from the Step Size and Start/Stop Frequency using formula  $\text{Sweep Point} = ((\text{Stop Frequency} - \text{Start Frequency}) / \text{Step Size}) + 1$ .
- Sweep Time, which will be converted from the Dwell Time using formula  $\text{Sweep Time} = \text{Dwell Time} * \text{Sweep Point}$ .
- Mechanical Attenuation
- Internal Preamp
- EMC Standard
- Reference Level

Key Path	Meas Setup, Scan Table
<b>Remote Command</b>	<code>[ :SENSE ] :FSCan :RANGe [ 1 ]   2   . . .   10 :SAnalyzer [ :IMMediate ]</code>
<b>Example</b>	FSC:RANG5:SAN Copies the parameters from range 5 of scan table to Spectrum Analyzer mode.
Dependencies	This key is grayed out during multi range scanning. If the grayed out key is pressed, an advisory message is generated. If the equivalent SCPI command is sent, this same message is generated as part of a “-221, Settings conflict; Function not available while running multirange scan” warning.  This key is grayed out during final measurement. If the grayed out key is pressed, an advisory message is generated. If the equivalent SCPI command is sent, this same message is generated as part of a “-221, Settings conflict” warning.
Couplings	The step size will be converted into sweep point when it switches into SA mode, $\text{Point} = (\text{Range Stop} - \text{Range Start}) / \text{Step Size} + 1$ . Point will be rounded to the nearest integer.
Initial S/W Revision	A.07.00

## Range Presets

Opens a menu that enables presetting of the selected scan range to CISPR or MIL bands.

<b>Key Path</b>	Meas Setup, Scan Table, Range Presets
<b>Remote Command</b>	[[:SENSe]:FSCan:RANGe[1] 2 ... 10:PRESet CISA   CISB   CISC   CISD   CISCD   CISE   MIL1K   MIL10K   MIL150K   MIL30M   MIL1G   MILGT1G
<b>Example</b>	FSC:RANG:PRES CISA Preset Range 1 to CISPR Band A setting. FSC:RANG:PRES CISB Preset Range 1 to CISPR Band B setting. FSC:RANG:PRES CISC Preset Range 1 to CISPR Band C setting. FSC:RANG:PRES CISD Preset Range 1 to CISPR Band D setting. FSC:RANG:PRES CISCD Preset Range 1 to CISPR Band CD setting. FSC:RANG:PRES CISE Preset Range 1 to CISPR Band E setting. FSC:RANG:PRES MIL1K Preset Range 1 to MIL Std 1 kHz setting. FSC:RANG:PRES MIL10K Preset Range 1 to MIL Std 10 kHz setting. FSC:RANG:PRES MIL150K Preset Range 1 to MIL Std 150 kHz setting. FSC:RANG:PRES MIL30M Preset Range 1 to MIL Std 30 MHz setting. FSC:RANG:PRES MIL1G Preset Range 1 to MIL Std 1 GHz setting. FSC:RANG:PRES MILGT1G Preset Range 1 to MIL Std >1 GHz (Greater Than 1GHz) setting.
<b>Dependencies</b>	This key is grayed out during multi range scanning. If the grayed out key is pressed, an advisory message is generated. If the equivalent SCPI command is sent, this same message is generated as part of a “-221, Settings conflict; Function not available while running multirange scan” warning. This key is grayed out during final measurement. If the grayed out key is pressed, an advisory message is generated. If the equivalent SCPI command is sent, this same message is generated as part of a “-221, Settings conflict” warning.
<b>Couplings</b>	Selecting CISPR Range Preset sets the EMI Standard in Mode Setup to CISPR. Selecting MIL Standard Preset sets the EMI Standard to MIL. It will also set the Y Axis Unit to dBμV (unless dBμV is grayed out, in which case it will leave the Y Axis Unit unaffected).
<b>Initial S/W Revision</b>	A.07.00

Selecting a CISPR Preset will set the start/ stop frequencies, step size (according to sweep point), and RBW of the selected range according to the table values shown below. Point/RBW will be set to 2 for Discrete and Smooth scan type.

CISPR Band	A	B	C	D	CD	E
<b>Start Frequency</b>	9 kHz	150 kHz	30 MHz	300 MHz	30 MHz	1 GHz
<b>Stop Frequency</b>	150 kHz	30 MHz	300 MHz	1 GHz	1 GHz	Max freq of analyzer or 18 GHz, whichever is lower
<b>RBW</b>	200 Hz	9 kHz	120 kHz	120 kHz	120 kHz	1 MHz
<b>Sweep Point</b>	1411	6635	4501	11667	16167	Refer below.
<b>Step Size</b>	100 Hz	4.5 kHz	60 kHz	60 kHz	60 kHz	500 kHz

The sweep point is based on two points for each RBW width. It is the smallest odd number  $\geq 2 \times (\text{Stop Frequency} - \text{Start Frequency}) / \text{RBW}$ . However, in this measurement, we are using step size instead of

sweep point. The Step Size is calculated by this formula:  $\text{Step Size} = (\text{Stop Frequency} - \text{Start Frequency}) / (\text{Sweep Point} - 1)$ .

Selecting a MIL Preset will set the start/ stop frequencies, step size (in according to sweep point), and RBW of the selected range according to the table values shown below. Point/RBW will be set to 2 for Discrete and Smooth scan type.

MIL Band	30 Hz - 1 kHz	1 kHz - 10 kHz	10 kHz - 150 kHz	150 kHz - 30 MHz	30 MHz - 1 GHz	Above 1 GHz
<b>Start Frequency</b>	30 Hz	1 kHz	10 kHz	150 kHz	30 MHz	1GHz
<b>Stop Frequency</b>	1 kHz	10 kHz	150 kHz	30 MHz	1 GHz	Max freq of analyzer or 18 GHz, whichever is lower
<b>RBW</b>	10 Hz	100 Hz	1 kHz	10 kHz	100 kHz	1 MHz
<b>Sweep Point</b>	195	181	281	5971	19401	Refer below.
<b>Dwell Time</b>	150 ms	15 ms	15 ms	15 ms	15 ms	15 ms
<b>Step Size</b>	5 Hz	50 Hz	500 Hz	5 kHz	50 kHz	500 kHz

The stop frequency of Band E depends on the maximum frequency, with a maximum of 18 GHz. The number of points in Band E is as below:

Option	Max Freq	Sweep Points
<b>503 (3.0 GHz Models)</b>	3.0 GHz	4001
<b>503 (3.6 GHz Models)</b>	3.6 GHz	5201
<b>507 (7 GHz Models)</b>	7.0 GHz	12001
<b>507 (7.5 GHz Models)</b>	7.5 GHz	13001
<b>508</b>	8.4 GHz	14801
<b>513</b>	13.2 GHz	24401
<b>526</b>	18 GHz	34001

## Scan Sequence

Displays the menu keys that enable you to control the measurement sequence. You need to select the Start key to start the selected measurement sequence. When Frequency Scan runs, some or all of the following steps are included:

### Scan:

If Scan is part of the current Scan Sequence, any hold or average trace will be reset. The Scan goes through all of the range tables that are currently on, and scans the specified range using the range table parameters. The detector(s) used for the scan are those specified in the Detectors menu under **Trace/Det.** Each trace whose display and update state are not Off is displayed as it is being built. A maximum of 3 traces can be running simultaneously. All setting changes are locked during the scan, but you are still able

to move the marker around on the trace(s). You may Pause or Stop the scan from the Sweep/ Control menu.

If there are no ranges turned on in scan table, an error is generated and the scan cannot be performed.

**Search:**

If Search is part of the current Scan Sequence, once the scan is complete, the measurement searches for peaks on the trace(s). The search is based on the current Search Criteria (set under the Meas Setup→ Limits key). At any given point, if any peak meets the search criteria, a frequency zoom is performed on the peak to determine the exact frequency of the peak. Next, the frequency will be added to the Signal List and the amplitude value is added into the detector column of that scan. A cross mark is added for each peak signal found on the trace. If there are multiple traces in the scan, the Search function applies to all traces. You may pause or stop the search from the Sweep/ Control menu.

If there is no valid trace data, an error is generated and a Search cannot be performed.

If no signal peak was added from the Search to Signal List because there are no signal peaks found within the defined parameters of the search criteria, an error is generated.

If the number of signals in the list reaches 2000, any trial to add additional peaks into the list will get an execution error.

If the signal peaks found are more than can fit in the signal list, you will be prompted by the following message that asks whether to continue or not:

WARNING! There is not enough free space in Signal List. Would you like to clear the Signal list before adding signals? Press ENTER to continue or ESC to Cancel.

**Measure:**

If Measure is part of the current Scan Sequence, the final measurement is performed on the signals in the signal list. This consists of making a zero span measurement on each peak using the specified final measurement detectors and dwell times. If there are multiple ranges selected in the scan table and the selected signal frequency falls into the range, the setting in the scan table will be used. Otherwise, for signals in the list that are outside the scan table range, the following Resolution BW, attenuation and preamp values will be used.

Resolution BW

- When the standard is “None”:

For frequencies above the scan table range, use the maximum RBW in the selected range(s). For frequencies below the scan table range, use the minimum RBW in the selected range(s).

- When the standard is “CISPR”:

Frequency	Resolution BW
Freq < 150 kHz	200 Hz
150 kHz ≤ Freq < 30 MHz	9 kHz
30 kHz ≤ Freq < 1 GHz	120 kHz
Freq > 1GHz	1 MHz

- When the standard is “MIL”:



Frequency	Resolution BW
Freq < 1 kHz	10 Hz
1 kHz ≤ Freq < 10 kHz	100 Hz
10 kHz ≤ Freq < 150 kHz	1 kHz
150 kHz ≤ Freq < 30 MHz	10 kHz
30 MHz ≤ Freq < 1GHz	100 kHz
Freq > 1GHz	1 MHz

#### Attenuation/ Preamp

- For frequencies above the displayed scan, use the attenuation and preamp settings for the highest frequency range used
- For frequencies below the displayed scan, use the attenuation and preamp settings for the lowest frequency range used

The amplitude and limit delta for the signals added in the signal list during peak search will be updated accordingly. Any positive limit value is shown in red. All setting changes will be locked, but you are still able to move the marker around. You may pause or stop the final measurement from the Sweep/ Control menu.

Key Path	Meas Setup
<b>Remote Command</b>	[ :SENSe ] :FSCan:SEquence SCAN   SEARCh   SSAMeasure   SASearch   SAMeasure   REMeasure  [ :SENSe ] :FSCan:SEquence?
<b>Example</b>	FSC:SEQ SCAN Select Scan as the scan sequence.
Notes	If an alignment is initiated while scan is running, the scan will be aborted and it will start over after the alignment concludes.  If an alignment is initiated while measure is running, the measure sequence will be paused and it will resume after the alignment concludes.  If a user switches out from Frequency Scan measurement, the current running scan sequence will be aborted.
Dependencies	This key is grayed out when a scan sequence is running. If the grayed out key is pressed, an advisory message is generated. If the equivalent SCPI command is sent, this same message is generated as part of a “-221, Settings conflict” warning.
Preset	SCAN
State Saved	Saved in instrument state.
Range	Scan Only Search Only Scan, Search and Measure Scan and Search Search and Measure Remeasure
Readback	Scan Search Scan-Srch-Meas Scan-Search Search-Meas [Remeas,Curr] [Remeas,All] [Remeas,Marked]
Initial S/W Revision	A.07.00

## Continuous

The scan will run continuously until you stop it by pressing the Stop key in the Sweep Control menu.

Key Path	Meas Setup, Scan Sequence
<b>Example</b>	FSC:SEQ SCAN
Dependencies	This key is grayed out when a scan sequence is running. If the grayed out key is pressed, an advisory message is generated. If the equivalent SCPI command is sent, this same message is generated as part of a “-221, Settings conflict” warning.
Initial S/W Revision	A.07.00

## Search Only

When this key is selected, pressing Start performs a search. See Section ["Scan Sequence" on page 471](#). If there are no valid peak signals found, an error is generated saying “No peak signals found”.

Key Path	Meas Setup, Scan Sequence
<b>Example</b>	FSC:SEQ SEAR
Dependencies	This key is grayed out when a scan sequence is running. If the grayed out key is pressed, an advisory message is generated. If the equivalent SCPI command is sent, this same message is generated as part of a “-221, Settings conflict” warning.
Initial S/W Revision	A.07.00

<b>Remote Command</b>	:CALCulate[1]   2:PEAKsearch PSEarch[:IMMEDIATE]
<b>Example</b>	CALC:PEAK
Notes	This command is included for ESU compatibility. The suffix [1]2 is irrelevant to the measurement, they are added solely for remote language compatibility This ESU Command is alias to FSC:SEAR:PEAK:COUN:STAT ON; FSC:SEQ SEAR;INIT.

## Scan, Search and Measure

When this key is selected, pressing Start performs a scan, search, and a final measurement. The scan will stop automatically and continue to search when the specified # of scans is complete regardless of Single/Continuous scan setting. See Section ["Scan Sequence" on page 471](#) for more information.

Key Path	Meas Setup, Scan Sequence
<b>Example</b>	FSC:SEQ SSAM
Dependencies	This key is grayed out when a scan sequence is running. If the grayed out key is pressed, an advisory message is generated. If the equivalent SCPI command is sent, this same message is generated as part of a “-221, Settings conflict” warning.
Initial S/W Revision	A.07.00

<b>Remote Command</b>	INITiate[1] 2:EMITest
<b>Example</b>	INIT:EMIT
<b>Notes</b>	This command is included for ESU compatibility. The suffix [1] 2 is irrelevant to the measurement, they are added solely for remote language compatibility This ESU Command is alias to FSC:SEQ SSAM;INIT

## Scan and Search

When this key is selected, pressing Start performs a scan and search. See Section ["Scan Sequence" on page 471](#) for more information.

<b>Key Path</b>	Meas Setup, Scan Sequence
<b>Example</b>	FSC:SEQ SAS
<b>Dependencies</b>	This key is grayed out when a scan sequence is running. If the grayed out key is pressed, an advisory message is generated. If the equivalent SCPI command is sent, this same message is generated as part of a "-221, Settings conflict" warning.
<b>Initial S/W Revision</b>	A.07.00

## Search and Measure

When this key is selected, pressing Start performs a search and a final measurement,. See Section ["Scan Sequence" on page 471](#).

<b>Key Path</b>	Meas Setup, Scan Sequence
<b>Example</b>	FSC:SEQ SAM
<b>Dependencies</b>	This key is grayed out when a scan sequence is running. If the grayed out key is pressed, an advisory message is generated. If the equivalent SCPI command is sent, this same message is generated as part of a "-221, Settings conflict" warning.
<b>Initial S/W Revision</b>	A.07.00

## Remeasure Type

Specifies the remeasure type, either on all signals, a current signal, or the marked signal in the peak list.

<b>Key Path</b>	Meas Setup, Scan Sequence, Remeasure
<b>Remote Command</b>	[ :SENSe ] :FSCan:SEquence:REMeasure CURRent MARKed ALL [ :SENSe ] :FSCan:SEquence:REMeasure?
<b>Example</b>	FSC:SEQ:REM MARK
<b>Notes</b>	If "Marked" is selected but no marked signal is found in the signal list, an error is generated and Remeasure cannot be performed.

Dependencies	This key is grayed out when a scan sequence is running. If the grayed out key is pressed, an advisory message is generated. If the equivalent SCPI command is sent, this same message is generated as part of a “-221, Settings conflict” warning.
Preset	CURRent
State Saved	Saved in instrument state.
Range	Curr Signal All Signals Marked Signals
Initial S/W Revision	A.07.00

<b>Remote Command</b>	:CONFigure:EMI:SLISt CURRent MARKed ALL
<b>Example</b>	CONF:EMI:SLIS MARK Perform remeasure on all marked signal.
Notes	CURRent aliases to :FSC:SEQ:REM CURR; :FSC:SEQ REMMARKed aliases to :FSC:SEQ:REM MARK; :FSC:SEQ REMALL aliases to :FSC:SEQ:REM ALL; :FSC:SEQ REM
Dependencies	This key is grayed out when a scan sequence is running. If the grayed out key is pressed, an advisory message is generated. If the equivalent SCPI command is sent, this same message is generated as part of a “-221, Settings conflict” warning.
Initial S/W Revision	A.07.00

## Detectors (Measure)

This key opens a menu that allows you to configure the detectors to be used for the Final Measurement and Measure at Marker reading. The same menu can be accessed from the Detectors key under the Marker Function menu. Any of the instrument’s detectors can be used for each of the three detectors, or any of the three can be turned off. The dwell time for each detector is also settable.

When performing a Final Measurement or Measure at Marker, the dwell time settings that you select will depend on the characteristics of the emission you are measuring. The default dwell time (200 ms) should work well for typical EUT emissions, but sometimes you will encounter emissions for which the defaults are not optimal. This is especially the case for emissions that vary slowly over time or have a slow repetition rate. By lengthening the dwell times you can increase the likelihood of accurately measuring these low repetition rate signals.

When a Final Measurement or Measure at Marker is activated, the receiver makes a zero span measurement for each of the (up to) three detectors selected, using the Dwell Time set for each detector. If the signal’s repetition period is greater than 200 ms (the default setting), the dwell time should be increased to capture at least two and preferably more repetitions of the signal. Additionally, if you do not need or do not wish to use a detector to make a measurement, that specific detector may be turned off.

Key Path	Meas Setup
Initial S/W Revision	A.07.00

## Select Detector

Specifies the selected detector. The “selected detector” is the detector that other parameters under the Final Measurement and Measure at Marker Detector menu will apply to.

Key Path	Meas Setup, Detectors (Measure)
Notes	Front panel only. The selected final detector is remembered even when not in the Detector Menu.
Preset	Detector 1, not affected by Mode Preset, preset by Restore Mode Defaults.
State Saved	Saved in instrument state.
Initial S/W Revision	A.07.00

## Dwell Time

Sets the dwell time for detectors

Key Path	Meas Setup, Detectors (Measure)												
<b>Remote Command</b>	<code>[ :SENSe ] :FSCan:FINal:DETEctor[1]   2   3 :DWELl &lt;dwell Time&gt;</code> <code>[ :SENSe ] :FSCan:FINal:DETEctor[1]   2   3 :DWELl?</code>												
<b>Example</b>	FSC:FIN:DET3:DWEL 300ms Set dwell time of detector 3 to 300 ms. FSC:FIN:DET3:DWEL?												
Notes	Not affected by a Mode Preset, preset by a Restore Mode Defaults. The minimum Dwell Time is coupled to the detector type:- a) When the Quasi Peak detector is selected, the minimum Dwell Time is 0.5 ms. b) When the EMI Average/ RMS Average detector is selected, the minimum Dwell Time is 0.1 ms. c) When the Peak/ Negative Peak detector is selected, the minimum Dwell Time is depends on the smallest RBW among ranges turned on in the Scan Table.												
	<table border="1"> <tr> <td>RBW ≤ 10 Hz</td> <td>10 ms</td> </tr> <tr> <td>10 Hz &lt; RBW &lt; 100 Hz</td> <td>1 ms</td> </tr> <tr> <td>100 Hz &lt; RBW &lt; 200 Hz</td> <td>1 ms</td> </tr> <tr> <td>200 Hz &lt; RBW &lt; 1 kHz</td> <td>0.1 ms</td> </tr> <tr> <td>1 kHz &lt; RBW &lt; 100 kHz</td> <td>0.1 ms</td> </tr> <tr> <td>≥ 100 kHz</td> <td>50 us</td> </tr> </table>	RBW ≤ 10 Hz	10 ms	10 Hz < RBW < 100 Hz	1 ms	100 Hz < RBW < 200 Hz	1 ms	200 Hz < RBW < 1 kHz	0.1 ms	1 kHz < RBW < 100 kHz	0.1 ms	≥ 100 kHz	50 us
RBW ≤ 10 Hz	10 ms												
10 Hz < RBW < 100 Hz	1 ms												
100 Hz < RBW < 200 Hz	1 ms												
200 Hz < RBW < 1 kHz	0.1 ms												
1 kHz < RBW < 100 kHz	0.1 ms												
≥ 100 kHz	50 us												
Dependencies	This key is grayed out during final measurement. If the grayed out key is pressed, an advisory message is generated. If the equivalent SCPI command is sent, this same message is generated as part of a “-221, Settings conflict” warning.												
Couplings	If “Off” is selected for detector 1, this key is grayed out and shows 200 ms.												
Preset	200 ms 1 s 1 s												
State Saved	Saved in instrument state.												
Min	1 ms 1 s 1 s												

Max	60 s
Default Unit	s
Initial S/W Revision	A.07.00

## Detector

Specifies the selected detector to be used for the Final Measurement and Measure at Marker, or to turn the selected Detector off. If you use the front panel to change the detector type, the following message will appear to remind you that the change of the detector will cause the data of the particular detector type column to be discarded.

Changing detector type will discard the detector values in the signal list, are you sure you want to do this?

Please press ENTER or OK to proceed. Press ESC or Cancel to close this dialog.

Key Path	Meas Setup, Detectors (Measure)
Remote Command	[ :SENSe ] :FSCan:FINal:DETEctor[1]   2   3 POSitive   QPEak   EAverage   RAverage   AVERAGE   NEGative   OFF  [ :SENSe ] :FSCan:FINal:DETEctor[1]   2   3 ?
Example	FSC:FIN:DET3 EAV Set detector 3 to EMI Average. FSC:FIN:DET3?
Notes	Not affected by Mode Preset, preset by Restore Mode Defaults.
Dependencies	The Average and EMI detectors are mutually exclusive. If the Average detector is selected, the other three EMI Detectors are grayed out, and vice versa. If the grayed out key is pressed, an advisory message is generated. If the equivalent remote command is sent, this same message is generated as part of a “-221, Settings conflict” warning.  This key is grayed out during final measurement. If the grayed out key is pressed, an advisory message is generated. If the equivalent SCPI command is sent, this same message is generated as part of a “-221, Settings conflict” warning.
Couplings	If the Measure at Marker window is being displayed, and one of the detectors is changed, any value being displayed for that detector changes to “---” until the next successful reading from that detector.  Any change of detector type will not be reflected on the signal list, until the next Final Measurement or Measure at Marker → List operation. Any values being displayed for that detector changes to “---”, until you perform a remeasure function for all the frequency values.
Preset	POSitive QPEak EAverage
State Saved	Saved in instrument state.
Range	Peak Quasi Peak EMI Average RMS Average Average Negative Peak Off
Initial S/W Revision	A.07.00

## Limit for $\Delta$

Selects the limit used by each final detector or measure at marker to get the limit delta value that goes in the Signal List. If you use the front panel to change the detector type, the following message will appear to remind you that the change of detector will cause the data of the particular detector type column to be discarded.

Changing limit for delta will discard the delta values, are you sure you want to do this?

Please press ENTER or OK to proceed. Press ESC or Cancel to close this dialog.

Key Path	Meas Setup, Detectors (Measure)
Remote Command	<code>[ :SENSe ] :FSCan:FINal:DETEctor[1]  2 3:LDELta &lt;limit Num&gt;</code> <code>[ :SENSe ] :FSCan:FINal:DETEctor[1]  2 3:LDELta?</code>
Example	<code>:FSC:FIN:DET3:LDEL 2</code> Set limit line 2 to be used by detector 3.
Notes	Not affected by Mode Preset, preset by Restore Mode Defaults.
Dependencies	This key is grayed out during final measurement. If the grayed out key is pressed, an advisory message is generated. If the equivalent SCPI command is sent, this same message is generated as part of a “-221, Settings conflict” warning.
Preset	1 1 1
State Saved	Saved in instrument state.
Range	1 2 3 4 5 6
Initial S/W Revision	A.07.00

## Autorange (Measure)

Accesses a menu that lets you decide whether or not to turn on the Autorange feature during the final measurement.

Key Path	Meas Setup
Readback	In square brackets, the state of Autorange then the state of Auto Preamp, separated by commas, as <code>[Rng:On, Pre:Off]</code>
Initial S/W Revision	A.07.00

## Autorange

When autorange is selected, the attenuation will be increased automatically when an overload is detected during the final measurement.

Key Path	Meas Setup, Autorange
Remote Command	<code>[ :SENSe ] :FSCan:FINal:ATTenuation:AUTO ON OFF 1 0</code> <code>[ :SENSe ] :FSCan:FINal:ATTenuation:AUTO?</code>
Example	<code>:FSC:FIN:ATT:AUTO 0</code>

	:FSC:FIN:ATT:AUTO?
Dependencies	This key is grayed out during final measurement. If the grayed out key is pressed, an advisory message is generated. If the equivalent SCPI command is sent, this same message is generated as part of a “-221, Settings conflict” warning.
Preset	OFF
State Saved	Saved in instrument state.
<b>Backwards Compatibility SCPI</b>	:SENSe1 SENSe2:SCAN[1] 2 ... 10:INPut:ATTenuation:AUTO [:SENSe]:SCAN[1] 2 ... 10:INPut:ATTenuation:AUTO
Backwards Compatibility SCPI Notes	This command above is included for ESU compatibility. The suffix [1]2 and [1]2 ... 10 are irrelevant to the measurement, they are added solely for remote language compatibility.
Initial S/W Revision	A.07.00

### Auto Preamp

When ON, Int Preamp will be considered in the autorange procedure to perform the final measurement. The internal preamp becomes active when the attenuation is reduced to the minimum settable value.

Key Path	Meas Setup, Autorange
<b>Remote Command</b>	[:SENSe]:FSCan:FINal:GAIN:AUTO ON OFF 1 0 [:SENSe]:FSCan:FINal:GAIN:AUTO?
<b>Example</b>	FSC:FINal:GAIN:AUTO ON FSC:FINal:GAIN:AUTO?
Dependencies	This key is grayed out during final measurement. If the grayed out key is pressed, an advisory message is generated. If the equivalent SCPI command is sent, this same message is generated as part of a “-221, Settings conflict” warning.
Couplings	When ON, Int Preamp (Meters) key will be unavailable.
Preset	OFF
State Saved	Saved in instrument state.
<b>Backwards Compatibility SCPI</b>	:SENSe1 SENSe2:SCAN[1] 2 ... 10:INPut:GAIN:AUTO [:SENSe]:SCAN[1] 2 ... 10:INPut:GAIN:AUTO
Backwards Compatibility SCPI Notes	This command above is included for ESU compatibility. The suffix [1]2 and [1]2 ... 10 are irrelevant to the measurement, they are added solely for remote language compatibility.
Initial S/W Revision	A.07.00

### # of Scans (Avg Number)

Determines how many scans to take before stopping (in Single) or moving on to the next step, depending on the current Scan Sequence. If in Continuous, and the Scan Sequence is Scan Only, this number is used as the Average/Hold number for Average, Max Hold and Min Hold trace types.

The equation for trace averaging is:



$$\text{New avg} = ((K-1)\text{Old avg} + \text{New data})/K,$$

where K is the number of averages accumulated. (In continuous mode, once K has reached the # of Scans, K stays at that value, providing a continuous running average.)

Key Path	Meas Setup
<b>Remote Command</b>	[ :SENSe ] :FSCan:SWEep:COUNT <integer> [ :SENSe ] :FSCan:SWEep:COUNT?
<b>Example</b>	FSC:SWE:COUN 10 FSC:SWE:COUN?
Dependencies	This key is grayed out when a scan sequence is running. If the grayed out key is pressed, an advisory message is generated. If the equivalent SCPI command is sent, this same message is generated as part of a “-221, Settings conflict” warning.
Preset	1
State Saved	Saved in instrument state.
Min	1
Max	999
<b>Backwards Compatibility SCPI</b>	:SENSe1   SENSe2 :SWEep:COUNT [ :SENSe ] :SWEep:COUNT
Backwards Compatibility SCPI Notes	This command above is included for ESU compatibility. The suffix 1 2 is irrelevant to the measurement, they are added solely for remote language compatibility.
Initial S/W Revision	A.07.00

## Scan Type

Specifies the scan type, either as Smooth, Discrete (Stepped) or Time Domain The scan will go through all of the range tables that are currently on, and scans the specified range using the range table parameters.

Key Path	Meas Setup
<b>Remote Command</b>	[ :SENSe ] :FSCan:SCAN:TYPE SMOoth   DISCrete   TDOMain [ :SENSe ] :FSCan:SCAN:TYPE?
<b>Example</b>	FSC:SCAN:TYPE SMO FSC:SCAN:TYPE?
Dependencies	This key is grayed out when scan sequence is running. If the grayed out key is pressed, an advisory message is generated. If the equivalent SCPI command is sent, this same message is generated as part of a “-221, Settings conflict” warning.  Discrete Scan Type does not appear in CXA. The key is gray out and sending the SCPI command will return Illegal Parameter Error.  Time Domain appears in models that have a DP2 or B40 license and the TDS license installed. The key is grayed out in all other models, and sending the SCPI command will return an Illegal Parameter Error.
Preset	SMOoth

State Saved	Saved in instrument state
Range	Smooth Discrete Time Domain
Readback Text	Smooth Discrete Time Domain
Initial S/W Revision	A.07.00
<b>Remote Command</b>	[ :SENSe ] :FREQuency:MODE CW FIXed SWEep SCAN TDOMain [ :SENSe ] :FREQuency:MODE?
<b>Example</b>	FREQ:MODE SCAN FREQ:MODE?
Notes	This command is included for ESU compatibility. The suffix [1]2 of SENSE node is irrelevant to the measurement, they are added solely for remote language compatibility. CW, FIX and SWEep alias to Smooth. SCAN aliases to Stepped. For CXA, SCAN aliases to Smooth. TDOMain alias to Time Domain. For models that is not supporting Time Domain Scan, TDOM aliases to Smooth. The query will return:- SWEep when Smooth is selected. SCAN when Discrete is selected.
Preset	SWEep
State Saved	Saved in instrument state.
<b>Backwards Compatibility SCPI</b>	[ :SENSe ] :FSCan:SCAN:TYPE STEPped SWEpt TDOMain :SENSe1 SENSe2:FREQuency:MODE STEPped SWEpt TDOMain
Initial S/W Revision	A.07.00

## Time Domain Setup

Pressing this key, when it is not selected, selects Time Domain as the Scan Type. Pressing this key, when it is already selected, accesses the Time Domain setup options. The two possible Time Domain scan types are “Impulse” (suitable for pulsed and continuous signals) and “CW” (optimized for continuous signals).

Key Path	Meas Setup
<b>Remote Command</b>	[ :SENSe ] :FSCan:SCAN:TDOMain:TYPE IMPulse CWave [ :SENSe ] :FSCan:SCAN:TDOMain:TYPE?
<b>Example</b>	FSCan:SCAN:TDOMain:TYPE IMPulse FSCan:SCAN:TDOMain:TYPE?
Preset	IMPulse
State Saved	Saved in instrument state
Initial S/W Revision	A.13.50

## Limits

Opens the Limit Lines menu that contains keys to control limit lines of the current measurement. Only the upper limit is used in the Frequency Scan measurement.

Key Path	Meas Setup
State Saved	Saved in instrument state.
Initial S/W Revision	A.07.00

## Select Limit

Specifies the selected limit. The term “selected limit” is used throughout this document to specify which limit will be affected by the functions.

Key Path	Meas Setup, Limits
Notes	Front panel only. The selected limit is remembered even when not in the Limit Menu.
Preset	Limit 1
State Saved	Saved in instrument state.
Initial S/W Revision	A.07.00

## Limit On/Off

Selects whether the limit and margin are displayed. If Test Limits is on, this also determines whether the test trace (see ["Test Trace" on page 484](#)) will be tested against the limit. If Limit On/Off is On, the following occurs:

- The limit line is displayed, in the same color, but paler, as the limited trace. Portions of traces that fail the limits will be displayed in red.
- The margin line is displayed if Margin is on and the Margin Value is non-zero (see ["Margin" on page 489](#)). The margin line is displayed in the same color as the limit line, but paler still and dashed. Portions of traces that pass the limits but fail the margin will be displayed in amber.
- The trace is tested for the purpose of the “Trace Pass/Fail” indication in the graticule if, in addition to Limit On/Off being On, the trace is displayed and Test Limits (All Limits) is on (see ["Test Limits \(All Limits\)" on page 496](#)). If the trace is not tested, no report of the trace passing or failing is seen on the graticule. Note that the SCPI queries of Limit Pass/Fail are independent of these conditions. The test is always performed when queried over SCPI.

The PASS/FAIL box in the corner of the Meas Bar is only displayed if there is at least one “Trace Pass/Fail” indication displayed in the graticule.

Note that the red and amber coloring of traces that fail the limits and/or margins only applies to traces whose X-axis corresponds to the current analyzer X-axis. Traces that are not updating (in View, for example) will not change color if the analyzer X-axis settings (e.g., start and stop frequency) do not match those of the trace, for example if they have been changed since the trace stopped updating. In this case, the Invalid Data indicator (\*) will appear in the upper right corner.

When the limits are frequency limits but the trace is a zero-span trace, the limit trace is drawn at the limit amplitude of the center frequency. When the limits are time limits but the trace is a frequency domain trace, the limit trace is drawn according to the current time axis, with the left of the screen being 0 and the right being equal to sweep time.

Key Path	Meas Setup, Limits
Remote Command	:CALCulate:FSCan:LLINe[1] 2 ... 6:DISPlay ON OFF 1 0 :CALCulate:FSCan:LLINe[1] 2 ... 6:DISPlay?
Example	CALC:FSC:LLIN2:DISP ON CALC:FSC:LLIN2:DISP?
Couplings	Limit display ON selects the limit. Testing is done on all displayed limits if Test Limits (All Limits) is ON. Entering the limit menu from the GUI turns on the selected limit.
Preset	OFF
State Saved	Saved in instrument state.
Range	On Off
Backwards Compatibility SCPI	:CALCulate[1] 2:LIMit[1] 2 ... 6:STATe
Backwards Compatibility SCPI Notes	This command above is included for ESU compatibility. The suffix [1]2 is irrelevant to the measurement, they are added solely for remote language compatibility.
Initial S/W Revision	A.07.00

## Properties

Accesses a menu that lets you set the properties of the selected limit.

Key Path	Meas Setup, Limits
Initial S/W Revision	A.07.00

## Select Limit

Specifies the selected limit. The term “selected limit” is used throughout this document to specify which limit will be affected by the functions.

Key Path	Meas Setup, Limits
Notes	Front panel only. The selected limit is remembered even when not in the Limit Menu.
Preset	Limit 1, not affected by Mode Preset, preset by Restore Mode Defaults.
State Saved	Saved in instrument state.
Initial S/W Revision	A.07.00

## Test Trace

Selects the trace that you want the limit to test. A limit is applied to one and only one trace.

A trace can have multiple limit lines simultaneously; in that case, only one upper limit line will affect the color of the trace. Other limit lines will be displayed, and will affect the pass/fail status, but the trace will not turn red if it crosses a secondary limit line.

Key Path	Meas Setup, Limits, Properties
Remote Command	:CALCulate:FSCan:LLINE[1] 2 ... 6:TRACe 1 2 3 :CALCulate:FSCan:LLINE[1] 2 ... 6:TRACe?
Example	CALC:FSC:LLIN3:TRAC 2 Applies limit 3 to trace 2.
Notes	When the trace display is off, the trace is not tested. The trace is tested only when the trace display is on and Test Limits (see "Test Limits (All Limits)" on page 496) is on.
Couplings	This matters when testing a trace or limit line for failure, via :CALC:FSC:LLIN3:FAIL? or :CALC:FSC:TRAC2:FAIL?
Preset	1 1 2 2 3 3
State Saved	Saved in instrument state.
Range	1 2 3
Initial S/W Revision	A.07.00

## Interpolation

Accesses a menu that lets you set the frequency and amplitude interpolation of the selected limit.

Key Path	Meas Setup, Limits, Properties
Readback	In square brackets, the state of Frequency Interpolation then the state of Amplitude Interpolation, separated by commas, as [Lin Frequency, Log Amplitude]
Initial S/W Revision	A.07.00

## Frequency Interpolation

Sets the interpolation between frequency points, allowing you to determine how limit trace values are computed between points in a limit table. The available interpolation modes are linear and logarithmic. If frequency interpolation is logarithmic (Log), frequency values between limit points are computed by first taking the logarithm of both the table values and the intermediate value. A linear interpolation is then performed in this logarithmic frequency space. An exactly analogous manipulation is done for logarithmic amplitude interpolation.

Note that the native representation of amplitude is in dB.

For linear amplitude interpolation and linear frequency interpolation, the interpolation is computed as:

$$y = 20 \log \left( \frac{10^{\frac{y_{i+1}}{20}} - 10^{\frac{y_i}{20}}}{f_{i+1} - f_i} (f - f_i) + 10^{\frac{y_i}{20}} \right)$$

For linear amplitude interpolation and log frequency interpolation, the interpolation is computed as:

$$y = 20 \log \left( \frac{10^{\frac{y_{i+1}}{20}} - 10^{\frac{y_i}{20}}}{\log f_{i+1} - \log f_i} (\log f - \log f_i) + 10^{\frac{y_i}{20}} \right)$$

For log amplitude interpolation and linear frequency interpolation, the interpolation is computed as:

$$y = \frac{y_{i+1} - y_i}{f_{i+1} - f_i} (f - f_i) + y_i$$

For log amplitude interpolation and log frequency interpolation, the interpolation is computed as:

$$y = \frac{y_{i+1} - y_i}{\log f_{i+1} - \log f_i} (\log f - \log f_i) + y_i$$

Note that Interpolation modes determine how limit values are computed between points in the limit table. The appearance of a limit trace is also affected by the amplitude scale, which may be linear or logarithmic.

Key Path	Meas Setup, Limits, Properties, Interpolation
Remote Command	:CALCulate:FSCan:LLINe[1] 2 ... 6:CONTRol:INTerpolate:TYPE LOGarithmic   LINear  :CALCulate:FSCan:LLINe[1] 2 ... 6:CONTRol:INTerpolate:TYPE?
Example	CALC:FSC:LLIN4:CONT:INT:TYPE LIN Sets limit line 4 frequency interpolation to linear.
Dependencies	This key is grayed out if Time is the selected X Axis Units.
Preset	Linear, not affected by Mode Preset, preset by Restore Mode Defaults.
State Saved	Saved in instrument state.
Range	Log Lin
Initial S/W Revision	A.07.00

### Amplitude Interpolation

Sets the interpolation to linear or logarithmic for the specified limiting points set, allowing you to determine how limit trace values are computed between points in a limit table. See "[Frequency Interpolation](#)" on page 485 for the equations used to calculate limit values between points.

Key Path	Meas Setup, Limits, Properties, Interpolation
Remote Command	:CALCulate:FSCan:LLINe[1] 2 ... 6:AMPLitude:INTerpolate:TYPE LOGarithmic   LINear  :CALCulate:FSCan:LLINe[1] 2 ... 6:AMPLitude:INTerpolate:TYPE?
Example	CALC:FSC:LLIN:AMPL:INT:TYPE LIN Sets limit line 1 amplitude interpolation to linear.
Preset	Linear, not affected by Mode Preset, preset by Restore Mode Defaults.
State Saved	Saved in instrument state.
Range	Log Lin
Initial S/W Revision	A.07.00

## Fixed/ Relative

Accesses a menu that enables you to specify that the selected limit is relative to either the Center Frequency or the Reference level.

Key Path	Meas Setup, Limits, Properties
Readback	[Fixed] – if both Relative to CF and RL set to OFF. [Rel to RL] – if only RL set to ON. [Rel to CF] – if only CF set to ON. [Rel to CF + RL] – if both Relative to CF and RL set to ON.
Initial S/W Revision	A.07.00

## Relative to CF

Chooses whether the limit line frequency points are coupled to the instrument center frequency, and whether the frequency points are expressed as an offset from the instrument center frequency. If the limit lines are specified with time, this has no effect. The limit table must in this case support negative frequencies.

For example, assume you have a frequency limit line, and the analyzer center frequency is at 1 GHz. If Relative to CF is “Off”, entering a limit line segment with a frequency coordinate of 300 MHz displays the limit line segment at 300 MHz, and the limit line segment will not change frequency if the center frequency changes. If Relative to CF is “On”, entering a limit line segment with a frequency coordinate of 300 MHz displays the limit line segment at CF + 300 MHz, or 1.3 GHz. Furthermore, if the center frequency changes to 2 GHz, the limit line segment will be displayed at CF + 300 MHz, or 2.3 GHz.

It is possible to change this setting after a limit line has been entered. When changing from On to Off or vice-versa, the frequency values in the limit line table change so that the limit line remains in the same position for the current frequency settings of the analyzer.

Key Path	Meas Setup, Limits, Properties, Fixed/Relative
Remote Command	:CALCulate:FSCan:LLINE[1] 2 ... 6:FREQUENCY:CMODE:RELative ON   OFF   1   0 :CALCulate:FSCan:LLINE[1] 2 ... 6:FREQUENCY:CMODE:RELative?
Example	CALC:FSC:LLIN:FREQ:CMOD:REL ON Makes limit line 1 relative to the Center freq.
Notes	If the Trace Domain is changed to Time (:CALCulate:LLINE:CONTROL:DOMAIN TIME), the SCPI command : :CALCulate:LLINE[1] 2 3 4 5 6:FREQUENCY:CMODE:RELative ON OFF 1 0 will have no effect.
Couplings	Pressing this button makes Center Frequency the active function.
Preset	Off, not affected by Mode Preset, preset by Restore Mode Defaults.
State Saved	Saved in instrument state.
Range	On Off
Initial S/W Revision	A.07.00

### Relative to RL

Chooses whether the limit line amplitude points are coupled to the instrument reference level, and whether the amplitude points are expressed as an offset from the instrument reference level.

For example, assume you have a limit line, and the reference level at  $-10$  dBm. If Relative to RL is “Off”, entering a limit line segment with an amplitude coordinate of  $-20$  dB displays the limit line segment at  $-20$  dBm, and the limit line segment will not change amplitude if the reference level amplitude changes. If Relative to RL is “On”, entering a limit line segment with an amplitude coordinate of  $-20$  dB displays the limit line segment at  $RL - 20$  dB, or  $-30$  dBm. Furthermore, if the reference level amplitude changes to  $-30$  dBm, the limit line segment will be displayed at  $RL - 20$  dB, or  $-50$  dBm.

It is possible to change this setting after a limit line has been entered. When changing from On to Off or vice-versa, the amplitude values in the limit line table change so that the limit line remains in the same position for the current reference level settings of the analyzer.

Key Path	Meas Setup, Limits, Properties, Fixed/Relative
Remote Command	:CALCulate:FSCan:LLINe[1] 2 ... 6:AMPLitude:CMODE:RELative ON   OFF   1   0  :CALCulate:FSCan:LLINe[1] 2 ... 6:AMPLitude:CMODE:RELative?
Example	CALC:FSC:LLIN:AMPL:CMOD:REL ON Makes limit line 1 relative to the reference level amplitude.
Couplings	Pressing this button makes Reference level the active function.
Preset	Off, not affected by Mode Preset, preset by Restore Mode Defaults.
State Saved	Saved in instrument state.
Range	On Off
Initial S/W Revision	A.07.00

### Description

Provides a description of up to 60 characters by which you can easily identify the limit. The descriptions will be stored in the exported file and can be displayed in the active function area by selecting them as the active function, if desired to be in a screen dump.

Key Path	Meas Setup, Limits, Properties
Remote Command	:CALCulate:FSCan:LLINe[1] 2 ... 6:DESCription "string" :CALCulate:FSCan:LLINe[1] 2 ... 6:DESCription?
Example	CALC:FSC:LLIN:DESC "European Emissions"
Preset	"" (null String), not affected by Mode Preset, preset by Restore Mode Defaults.
State Saved	Saved in instrument state.
Backwards Compatibility SCPI	:CALCulate[1] 2:LIMit[1] 2 ... 6:NAME
Backwards Compatibility SCPI Notes	The suffix [1]2 is irrelevant to the measurement, they are added solely for remote language compatibility.
Initial S/W Revision	A.07.00



## Comment

Sets an ASCII comment field, which will be stored in an exported file. The comment can be displayed in the active function area by selecting it as the active function, if desired to be in a screen dump. The Limits .csv file supports this field.

Key Path	Meas Setup, Limits, Properties
Remote Command	:CALCulate:FSCan:LLINe[1] 2 ... 6:COMMeNt "string" :CALCulate:FSCan:LLINe[1] 2 ... 6:COMMeNt ?
Example	CALC:FSC:LLIN:COMM "European Emissions"
Preset	"" (null String), not affected by Mode Preset, preset by Restore Mode Defaults.
State Saved	Saved in instrument state.
Backwards Compatibility SCPI	:CALCulate[1] 2:LIMit[1] 2 ... 6:COMMeNt
Backwards Compatibility SCPI Notes	This command above is included for ESU compatibility. The suffix [1]2 is irrelevant to the measurement, they are added solely for remote language compatibility.
Initial S/W Revision	A.07.00

## Margin

Selects a margin for this limit, which will cause a trace to Fail Margin when the trace is between the limit line and the margin line. Portions of the traces that pass the limit but fail the margin will be displayed in an amber color. .

A margin is always specified in dB relative to a limit. Since there is only an upper limit in the Frequency Scan measurement, the margin is always negative. If a value is entered with the incorrect sign, the system will automatically take the negative of the entered value.

When the Margin is selected, it may be turned off by pressing the Margin key until Off is underlined. This may also be done by performing a preset. Margin is the default active function whenever the margin is on, and it is not the active function whenever the margin is off.

The margin lines are displayed in the same color, but paler, as limit lines. If the limited trace is blanked then the limit line and the margin line will be blanked as well.

Key Path	Meas Setup, Limits
Remote Command	:CALCulate:FSCan:LLINe[1] 2 ... 6:MARGIn <rel_ampl> :CALCulate:FSCan:LLINe[1] 2 ... 6:MARGIn? :CALCulate:FSCan:LLINe[1] 2 ... 6:MARGIn:STATe ON OFF 1 0 :CALCulate:FSCan:LLINe[1] 2 ... 6:MARGIn:STATe?
Example	CALC:FSC:LLIN6:MARG -4dB Set Limit line 6's margin to -4 dB. CALC:FSC:LLIN2:MARG:STAT OFF ! Turns off the margin for limit line 2 and removes any tests associated with that margin line.
Notes	The queries "Limit Line Fail?" :CALCulate:FSCan:LLINe[1]2 3 4 5 6:FAIL? will return 1 if the margin fails.

Preset	Not affected by Mode Preset, set to 0 dB for all Limits by Restore Mode Defaults.
State Saved	Saved in instrument state.
Min	-40 dB
Max	0 dB
Default Unit	dB
Initial S/W Revision	A.07.00

### Edit Limit

Opens the Table Editor for the selected limit line. We use the same table editor as Amplitude Correction; see the Input/Output chapter of the Mode Common PD for a full description of the Table Editor.

Key Path	Meas Setup
Initial S/W Revision	A.07.00

### Navigate

Enables you to move through the table to edit the desired point

Key Path	Meas Setup, Limits, Edit
Notes	There is no value readback on the key
Min	1
Max	2000
Initial S/W Revision	A.02.00

### Frequency

Enables you to edit the frequency of the current row.

Key Path	Meas Setup, Limits, Edit
Notes	There is no value readback on the key
Min	0
Max	1 THz
Initial S/W Revision	A.02.00

### Amplitude

Enables you to edit the Amplitude of the current row.

Key Path	Meas Setup, Limits, Edit
Notes	There is no value readback on the key
Min	-1000 dBm
Max	1000 dBm
Initial S/W Revision	A.02.00

### Insert Point Below

Pressing this key inserts a point below the current point. The new point is a copy of the current point. And becomes the current point. The new point is not yet entered into the underlying table, and the data in the row is displayed in light gray.

Key Path	Meas Setup, Limits, Edit
Initial S/W Revision	A.02.00

### Delete Point

This is an immediate action key. It will immediately delete the currently-selected point, whether or not that point is being edited, and select Navigate. The point following the currently-selected point (or the point preceding if there is none) will be selected.

Key Path	Meas Setup, Limits, Edit
Initial S/W Revision	A.02.00

### Copy from Limit

Copies an existing limit into the current limit, including all secondary parameters (Description, Associated Trace, Type, Margin, Interpolation, Relative to CF/RL).

Key Path	Meas Setup, Limits, Edit
<b>Remote Command</b>	:CALCulate:FSCan:LLINE[1] 2 ... 6:COPY LLINE1   LLINE2   LLINE3   LLINE4   LLINE5   LLINE6
<b>Example</b>	CALC:FSC:LLINE2:COPY LLINE1 Copies the data from limit 1 into limit 2.
Notes	Auto return to the Edit menu.
<b>Backwards Compatibility SCPI</b>	:CALCulate[1] 2:LIMit[1] 2 ... 6:COPY
Backwards Compatibility SCPI Notes	This command above is included for ESU compatibility. The suffix [1]2 is irrelevant to the measurement, they are added solely for remote language compatibility.
Initial S/W Revision	A.07.00

### Build From Trace

Builds a limit using an existing trace. This command will overwrite all data in the limit. Since a straight copy would typically have hundreds or thousands of segments, the data will be approximated to better represent a limit line; small excursions whose width is less than 10 trace buckets will sometimes not be captured. Secondary parameters that are not associated with traces (Description, Associated Trace, Type, Margin, Interpolation, Relative to CF/RL) will be unchanged.

When taking a trace in order to build a limit, it will often work well to take the trace with a resolution bandwidth wider than the expected measurement, a video bandwidth lower than the expected measurement, and with the detector set to Max Hold or Min Hold.

The limit will be built above the trace. If the trace is constant, the limit should pass after being built.

Key Path	Meas Setup, Limits, Edit
Remote Command	:CALCulate:FSCan:LLINe[1] 2 ... 6:BUILd TRACE1 TRACE2 TRACE3
Example	CALC:FSC:LLIN2:BUIL TRACE1 Builds limit line 2 based on the data in trace 1. This will overwrite the data in the table editor.
Notes	Auto return to Edit menu.
Initial S/W Revision	A.07.00

### Offset

Enters a menu that allows you to offset the limit trace by a specified frequency, time, or amplitude. The offsets will be immediately applied to the limit trace for display and failure calculation. The offset can also be applied to the points in the limit line.

Key Path	Meas Setup, Limits, Edit
Initial S/W Revision	A.07.00

### X Offset

Offsets the limit trace by some specified frequency (for Frequency-based limit lines) or a time (for time-based limit lines).

Key Path	Meas Setup, Limits, Edit, Offset
Remote Command	:CALCulate:FSCan:LLINe[1] 2 ... 6:OFFSet:X <freq> :CALCulate:FSCan:LLINe[1] 2 ... 6:OFFSet:X?
Example	CALC:FSC:LLIN:OFFS:X -50MHZ Sets the X axis offset to -50 MHz. CALC:FSC:LLIN:OFFS:UPD Applies the X axis offset to all points in the limit line, then reset the X axis offset to zero.
Preset	0 Hz if Limit X-Axis Unit is Frequency 0 S if Limit X-Axis Unit is Time
State Saved	Saved in instrument state.

Min	-500 GHz
Max	500 GHz
Default Unit	Determined by X axis scale.
Initial S/W Revision	A.07.00

### Y Offset

Offsets all segments in the limit line by some specified amplitude.

Key Path	Meas Setup, Limits, Edit, Offset
<b>Remote Command</b>	:CALCulate:FSCan:LLINE[1] 2 ... 6:OFFSet:Y <rel_ampl> :CALCulate:FSCan:LLINE[1] 2 ... 6:OFFSet:Y?
<b>Example</b>	CALC:FSC:LLIN:OFFS:Y -3 dB Sets the Y axis offset to -3 dB. CALC:FSC:LLIN:OFFS:UPD Applies the Y axis offset to all points in the limit line, then reset the Y axis offset to zero.
Preset	0 dB
State Saved	Saved in instrument state.
Min	-9.9E+37
Max	9.9E+37
Default Unit	dB
Initial S/W Revision	A.07.00

### Apply Offset to Limit Table

Adds the X and Y offsets to each point in the limit table, then resets the X and Y offset values to zero. This has no effect on the position of the limit trace.

For example, if the X offset is -10 MHz and the Y offset is 1 dB, the values in the limit table will be updated as follows: 10 MHz will be subtracted from each X value, 1 dB will be added to each Y value. The offset values will then be reset to zero. The limit trace will not be moved and the limit table will be updated to accurately reflect the currently displayed limit trace.

Key Path	Meas Setup, Limits, Edit, Offset
<b>Remote Command</b>	:CALCulate:FSCan:LLINE[1] 2 ... 6:OFFSet:UPDate
<b>Example</b>	CALC:FSC:LLIN3:OFFS:UPD Updates the limit table 3 to reflect the X and Y offsets, then resets the offsets to zero.
Initial S/W Revision	A.07.00

### Scale X Axis

Matches the X Axis to the selected Limit, as close as possible.

For frequency limits and a frequency-domain X-axis, sets the Start and Stop Frequency to contain the minimum and maximum Frequency of the selected Limit. The range between Start Frequency and Stop Frequency is 12.5% above the range between the minimum and maximum Frequency so that the span exceeds this range by one graticule division on either side.

For time limits and a time-domain X-axis, sets the sweep time to match the maximum Time of the selected Limit.

If the domain of the selected limit does not match the domain of the X Axis, no action is taken. Standard clipping rules apply, if the value in the table is outside the allowable range for the X axis.

Key Path	Meas Setup, Limits, Edit
Initial S/W Revision	A.07.00

### Search Criteria

This menu lets you decide the Search mode.

When Peak Criteria Only is selected, performing a Search finds the peaks that met the Excursion and Threshold under the Next Peak Criteria menu under the Peak Search key.

If Peak Criteria and Limits is selected, the search is also forced to consider the Limits and Margin if any of them are turned on.

When Subranges and Limits is selected, the whole span from Start Frequency to Stop Frequency is divided into equal width of subranges in log or linear based on frequency scale. The number of subranges depends on the value of # of Subranges. Performing a search finds the peaks for each subrange, and the peaks that exceed the Limits and Margin (if any of them are turn on) will be added into signal list.

Key Path	Meas Setup, Limits
Remote Command	[ :SENSe ] :FSCan:SEARch:MODE PONLy PLIMits SLIMits [ :SENSe ] :FSCan:SEARch:MODE?
Example	FSC:SEAR:MODE PONL
Notes	PONLy= Peak Criteria Only PLIMits= Peak Criteria and Limits SLIMits= Subranges and Limits
Preset	PLIMits
State Saved	Saved in instrument state.
Range	Peak Criteria Only Peak Criteria and Limits Subranges and Limits
Readback Text	Current state
Initial S/W Revision	A.07.00

### Peak Criteria Only

When this key is selected, performing search or issuing the equivalent remote command will add peaks into the signal list, subject to the peak-criteria qualifications defined in section "[Peak Criteria](#)" on page 516

Key Path	Meas Setup, Limits, Search Criteria
<b>Example</b>	FSC:SEAR:MODE PONL
Readback Text	Peak Criteria Only
Initial S/W Revision	A.07.00

### Peak Criteria and Limits

When this key is selected, performing a search or issuing the equivalent remote command will add peaks that meet the limits and margin that is turned on into the signal list. The search is also subject to the peak-criteria qualifications defined in section "[Peak Criteria](#)" on page 516.

Key Path	Meas Setup, Limits, Search Criteria
<b>Example</b>	FSC:SEAR:MODE PLIM
Readback Text	Pk Crit and Limits
Initial S/W Revision	A.07.00

### Subranges and Limits

When this key is selected, performing a search or issuing the equivalent remote command will divide the whole frequency range into equal width subranges. The peak will be determined for each subranges and peaks that exceed the limits and margin that is turned on will be added into the signal list.

Key Path	Meas Setup, Limits, Search Criteria
<b>Example</b>	FSC:SEAR:MODE SLIM
Readback Text	Subranges & Limits
Initial S/W Revision	A.11.00

### # of Peaks

When turned on, determines how many peaks to find during Search when Search Criteria is set to "Peak Criteria Only" or "Peak Criteria and Limits".

Key Path	Meas Setup, Limits, Search Criteria
<b>Remote Command</b>	[ :SENSe ] :FSCan:SEARch:PEAK:COUNt <integer> [ :SENSe ] :FSCan:SEARch:PEAK:COUNt? [ :SENSe ] :FSCan:SEARch:PEAK:COUNt:STATe ON OFF 1 0 [ :SENSe ] :FSCan:SEARch:PEAK:COUNt:STATe?

<b>Example</b>	FSC:SEAR:PEAK:COUN 10 FSC:SEAR:PEAK:COUN? FSC:SEAR:PEAK:COUN:STAT OFF ! Turns off # of Peaks.
Preset	25 OFF
State Saved	Saved in instrument state.
Min	1
Max	500
Initial S/W Revision	A.11.00

### # of Subranges

Determines how many ranges that the whole span from Start Frequency to Stop Frequency will be divided to when Search Criteria is set to “Subranges and Limits”.

<b>Key Path</b>	Meas Setup, Limits, Search Criteria
<b>Remote Command</b>	[ :SENSe ] :FSCan :SEARch :SUBRange :COUNT <integer> [ :SENSe ] :FSCan :SEARch :SUBRange :COUNT?
<b>Example</b>	FSC:SEAR:SUBR:COUN 10 FSC:SEAR:SUBR:COUN?
Preset	25
State Saved	Saved in instrument state.
Min	1
Max	500
Initial S/W Revision	A.11.00

### Test Limits (All Limits)

Selects whether displayed traces are tested against displayed limits (i.e. those for which Limit On/Off is set to On).

For each displayed trace for which a Limit is turned on, a message will be displayed in the upper-left corner of the graticule to notify whether the trace passes or fails the limits.

If the trace is at or within the bounds of all applicable limits and margins, the text “Trace x Pass” will be displayed in green, where x is the trace number. A separate line is used for each reported trace.

If the trace is at or within the bounds of all applicable limits, but outside the bounds of some applicable margin, the text “Trace x Fail Margin” will be displayed in amber, where x is the trace number. A separate line is used for each reported trace.

If the trace is outside the bounds of some applicable limits, the text “Trace x Fail” will be displayed in red, where x is the trace number. A separate line is used for each reported trace.



If the trace has no enabled limits, or the trace itself is not displayed, no message is displayed for that trace. The PASS/FAIL box in the corner of the Meas Bar is only displayed if there is at least one “Trace Pass/Fail” indication displayed in the graticule.

If two amplitude values are entered for the same frequency, a single vertical line is the result. In this case, if an upper line is chosen, the lesser amplitude is tested. If a lower line is chosen, the greater amplitude is tested.

This command only affects the display, and has no impact on remote behavior. Limit queries over SCPI test the trace against the limit regardless of whether the trace or the limit is turned on (exception: the query :CALCulate:FSCan:TRACe[1]|2|3|4|5|6:FAIL? tests only the limits that are turned on for that trace).

The test limits button is global to all displayed limits, to prevent the failing case wherein someone intends to turn on two limit tests, but accidentally forgets. If someone really wants a limit to not apply, they can set it to a non-displaying trace.

Key Path	Meas Setup, Limits
<b>Remote Command</b>	:CALCulate:FSCan:LLINe:TEST ON OFF 1 0 :CALCulate:FSCan:LLINe:TEST?
<b>Example</b>	CALC:FSC:LLIN:TEST ON CALC:FSC:LLIN:TEST?
Preset	On, not affected by Mode Preset, preset by Restore Mode Defaults.
State Saved	Saved in instrument state.
Range	On Off
Initial S/W Revision	A.07.00

## Update $\Delta$ Limits

Pressing this key will updates the detector  $\Delta$  limit columns in signal list to the current limit lines. This only applies to a signal added from trace, which has a valid trace number under trace column. The limits associated for the trace will be used for each signals.

Key Path	Meas Setup, Limits
<b>Remote Command</b>	:CALCulate:FSCan:SLIS:LDELta:UPDate
<b>Example</b>	CALC:FSC:SLIS:LDEL:UPD
Initial S/W Revision	A.07.00

## Delete Limit

Deletes the currently selected limit line. Pressing Delete Limit purges the data from the limit line tables.

Limit data, including secondary parameters such as description, margin value, etc., will be cleared and returned to factory preset settings.

When this key is pressed a prompt is placed on the screen that says “Please press Enter or OK key to delete limit. Press ESC or Cancel to close this dialog.” The deletion is only performed if you press OK or Enter; if so, after the deletion, the informational message “Limit deleted” appears in the MSG line.

Key Path	Meas Setup, Limits
Remote Command	:CALCulate:FSCan:LLINe[1] 2 ... 6:DElete
Example	CALC:FSC:LLIN3:DEL Deletes all data for limit line 3
Backwards Compatibility SCPI	:CALCulate[1] 2:LIMit[1] 2 ... 6:DElete
Backwards Compatibility SCPI Notes	This command above is included for ESU compatibility. The suffix [1]2 is irrelevant to the measurement, they are added solely for remote language compatibility.
Initial S/W Revision	A.07.00

### Delete All Limits

Deletes all limit lines. Pressing Delete All Limits purges the data from all limit line tables.

All limit data will be cleared and returned to factory preset settings.

When this key is pressed a prompt is placed on the screen that says “Please press Enter or OK key to delete all limits. Press ESC or Cancel to close this dialog.” The deletion is only performed if you press OK or Enter. After a deletion, the informational message “All Limits deleted” appears in the MSG line.

Key Path	Meas Setup, Limits
Remote Command	:CALCulate:FSCan:LLINe:ALL:DElete
Example	CALC:FSC:LLIN:ALL:DEL
Initial S/W Revision	A.07.00

### Limit Line Fail? (Remote Command Only)

Tests a limit line against its associated trace. Returns a 0 if the trace is within the limit and margin, a 1 if the trace exceeds either the limit or the margin.

Note that this command only tests one limit line – other limit lines are not tested when executing this command. To see whether a trace passed all limits, use :CALCulate:FSCan:TRACE:FAIL?.

Note this command performs the test regardless of whether the trace or the limit is turned on, on the display.

Remote Command	:CALCulate:FSCan:LLINe[1] 2 ... 6:FAIL?
Example	CALC:FSCan:LLIN:FAIL? Returns a zero if limit line 1’s associated trace has no failure, 1 if there is a margin or limit failure.
Backwards Compatibility SCPI	:CALCulate[1] 2:LIMit[1] 2 ... 6:FAIL?
Backwards Compatibility	This command above is included for ESU compatibility. The suffix [1]2 is irrelevant to the

SCPI Notes	measurement, they are added solely for remote language compatibility.
Initial S/W Revision	A.07.00

### Trace Fail? (Remote Command Only)

Tests a trace against all associated limit lines. Returns a 0 if the trace is within all limits and margins, a 1 if the trace exceed either the limit or the margin. If no limits apply to the selected trace, this will automatically return a 0.

Only applies to limits that are turned on, if a Limit is off it will not be tested. If a Trace is not displaying it will still be tested, and if Test Limits (All Limits) is off the Trace will still be tested.

This command ignores limit lines that are assigned to other traces.

<b>Remote Command</b>	:CALCulate:FSCan:TRACe[1] 2 3:FAIL?
<b>Example</b>	CALC:FSC:TRAC3:FAIL? returns a zero if there is no failure, 1 if the trace exceeds either the limit or the margin.
Initial S/W Revision	A.07.00

### Limit Line Control (Remote Command Only)

Defines a list of limit line control (frequency or time) values for a given limit line. Up to 2000 points may be defined for each limit using the following parameters.

<x> Frequency or time values as specified by :Calculate:FSC:LLINe:CONTrol:DOMain. Units default to Hz (for frequency) and seconds (for time).

Range: -30 Gs to +30 Gs for time limits, -3 kHz to +1200 GHz for frequency limits.

<b>Remote Command</b>	:CALCulate:FSCan:LLINe[1] 2 ... 6:CONTrol[:DATA] <x>, <x>, ... :CALCulate:FSCan:LLINe[1] 2 ... 6:CONTrol[:DATA]?
<b>Example</b>	CALC:FSC:LLIN:CONT 1GHz, 2GHz, 2GHz, 3GHz Describes the X values of a stair-stepped limit line. CALC:FSC:LLIN:CONT?
Preset	Unaffected by Preset
State Saved	Saved in instrument state.
<b>Backwards Compatibility SCPI</b>	:CALCulate[1] 2:LIMit[1] 2 ... 6:CONTrol[:DATA]
Backwards Compatibility SCPI Notes	This command above is included for ESU compatibility. The suffix 1 2 is irrelevant to the measurement, they are added solely for remote language compatibility.
Initial S/W Revision	A.07.00

<b>Remote Command</b>	:CALCulate:FSCan:LLINe[1] 2 ... 6:CONTrol:POINTs?
-----------------------	---

<b>Example</b>	CALC:FSC:LLIN:CONT:POIN? Returns the number of points in the limit line.
Preset	1
State Saved	Saved in instrument state.
Initial S/W Revision	A.07.00

### Limit Line Upper (Remote Command Only, SCPI standard compatibility)

Defines a list of amplitude values for a given limit line. Changing the number of elements in the list spectrum will automatically turn the limit line off. Using the “UPP” syntax defines an upper limit line. There is no lower limit line in Frequency Scan measurement. Up to 200 points may be defined for each limit using the following parameters.

<ampl>Amplitude values units default to dBm.

Range: -200 dBm to +100 dBm

The points query returns the number of points in the amplitude list. It will not be possible to turn on the limit line unless the number of points in the control matches the number of points in the amplitude.

The points query returns the number of points in the amplitude list. It should match the number of points in the control, that is, the number of values for the CONTROL axis and for the corresponding limit lines must be identical. If one array is larger than the other, the limit trace is built using only as much data as is contained in the smaller array.

An empty array returns the system error “list is empty” to a data query, 0 to a POINTs query.

<b>Remote Command</b>	:CALCulate:FSCan:LLINe[1] 2 ... 6:UPPer[:DATA] <ampl>, <ampl>, ... :CALCulate:FSCan:LLINe[1] 2 ... 6:UPPer[:DATA]?
<b>Example</b>	:CALC:FSC:LLIN:UPP -10, -10, -20, -20 describes the amplitude values of an upper limit line
Preset	Limit line data is cleared by Restore Mode Defaults.
State Saved	Saved in instrument state.
<b>Backwards Compatibility SCPI</b>	:CALCulate:LIMit[1] 2 ... 6:UPPer[:DATA]
Initial S/W Revision	A.07.00

<b>Remote Command</b>	:CALCulate:FSCan:LLINe[1] 2 ... 6:UPPer:POINTs?
<b>Example</b>	:CALC:FSC:LLIN:UPP:POIN? returns the number of points in the upper limit line.
Preset	Upper Limit line data/points is cleared by Restore Mode Defaults.
State Saved	Saved in instrument state.
Initial S/W Revision	A.07.00

## Analog Demod Tune and Listen

The Analog Demod Tune and Listen key opens the Analog Demod menu that contains keys to turn the demod function on and off and select modulation type.

When the function is on (set to AM, FM, or  $\Phi$ M), the demodulated signal is fed to the analyzer's speaker. Muting and volume control functions are done through the standard Windows speaker volume control interface.

Key Path	Meas Setup
Remote Command	[ :SENSe ] :FSCan:DEMod AM FM PM OFF [ :SENSe ] :FSCan:DEMod?
Example	FSC:DEM AM Turns ON amplitude demodulation function. FSC:DEM?
Dependencies	Tune & Listen is only for Meters, which means that there will be no tune & Listen if any of the scan sequences are running. When Tune & Listen is turned on, only Meter 1 will return the valid measurement result. Meter 2 & 3 will return -1000dBm. Meter 2 & 3 will return valid measurement results when Turn & Listen is turned off.
Couplings	This key is grayed out when a scan sequence is running. If the grayed out key is pressed, an advisory message is generated. If the equivalent SCPI command is sent, this same message is generated as part of a "-221, Settings conflict" warning.
Preset	OFF
State Saved	Saved in instrument state.
Range	AM FM PM Off
Readback Text	AM FM PM Off
Backwards Compatibility SCPI	:SENSe1   SENSe2 :DEMod [ :SENSe ] :DEMod
Backwards Compatibility SCPI Notes	This command above is included for ESU compatibility. The suffix 1 2 is irrelevant to the measurement, they are added solely for remote language compatibility. This SCPI is Meas Local and Context Sensitive.
Initial S/W Revision	A.07.00

## AM

Pressing this key, when it is not selected, selects and activates the AM demodulation function. Pressing it a second time branches to the AM Demod menu where AM demodulation settings can be adjusted.

Key Path	Meas Setup, Analog Demod
Example	FSC:DEM AM Turns AM demodulation function ON.
State Saved	Saved in instrument state.
Initial S/W Revision	A.07.00

## FM

Pressing this key, when it is not selected, selects and activates the FM demodulation function. Pressing it a second time branches to the FM Demod menu where FM demodulation settings can be adjusted.

Key Path	Meas Setup, Analog Demod
<b>Example</b>	FSC:DEM FM Turns FM demodulation function ON.
State Saved	Saved in instrument state.
Initial S/W Revision	A.07.00

## De-emphasis (FM Demod Only)

The De-emphasis setting controls a single-pole filter (6 dB/octave roll off), usually to counter intentional pre-emphasis in the transmitter. When De-emphasis state is OFF the hardware digital filter is bypassed, otherwise the setting is applied.

Key Path	Meas Setup, Analog Demod, FM
<b>Remote Command</b>	[ :SENSe ] :FSCan:DEMod:FM:DEEMphasis OFF US25 US50 US75 US750 [ :SENSe ] :FSCan:DEMod:FM:DEEMphasis?
<b>Example</b>	FSC:DEM:FM:DEEM US75 FSC:DEM:FM:DEEM?
Dependencies	This key is grayed out when a scan sequence is running. If the grayed out key is pressed, an advisory message is generated. If the equivalent SCPI command is sent, this same message is generated as part of a “-221, Settings conflict” warning. Only available in FM. Grayed out for AM and PM.
Preset	US75 (recommended for US commercial FM 75 $\mu$ s pre-emphasis)
State Saved	Saved in instrument state.
Range	Off 25(s) 50(s) 75(s) 750(s)
Initial S/W Revision	A.07.00

## Off

This setting bypasses the De-emphasis filter.

Key Path	Meas Setup, Analog Demod, FM, De-emphasis
<b>Example</b>	FSC:DEM:FM:DEEM OFF
Readback	Off
Initial S/W Revision	A.07.00

## 25 $\mu$ s

Sets the De-emphasis time constant to 25 $\mu$ s.

Key Path	Meas Setup, Analog Demod, FM, De-emphasis
<b>Example</b>	FSC:DEM:FM:DEEM US25
Readback	25 ∞s
Initial S/W Revision	A.07.00

50 μs

Sets the De-emphasis time constant to 50 μs.

Key Path	Meas Setup, Analog Demod, FM, De-emphasis
<b>Example</b>	FSC:DEM:FM:DEEM US50
Readback	50 ∞s
Initial S/W Revision	A.07.00

75 μs

Sets the De-emphasis time constant to 75 μs.

Key Path	Meas Setup, Analog Demod, FM, De-emphasis
<b>Example</b>	FSC:DEM:FM:DEEM US75
Readback	75 ∞s
Initial S/W Revision	A.07.00

750 μs

Sets the De-emphasis time constant to 750 μsec.

Key Path	Meas Setup, Analog Demod, FM, De-emphasis
<b>Example</b>	FSC:DEM:FM:DEEM US750
Readback	750 ∞s
Initial S/W Revision	A.07.00

## ΦM

Pressing this key, when it is not selected, selects and activates the PM demodulation function. Pressing it a second time branches to the PM Demod menu where PM demodulation settings can be adjusted.

Key Path	Meas Setup, Analog Demod
<b>Example</b>	FSC:DEM PM Turns PM demodulation function ON.
State Saved	Saved in instrument state.
Initial S/W Revision	A.07.00

## Off

Pressing this key, turns the demodulation function off.

Key Path	Meas Setup, Analog Demod
<b>Example</b>	:FSC:DEM OFF Turns off demodulation function.
State Saved	Saved in instrument state.
Initial S/W Revision	A.07.00

## LISN Control (Measure)

This menu enables you to access LISN related functions. LISN control is only available in the MXE with option LSN, which indicates the availability of IO board. Otherwise, the key will not be shown.

Key Path	Meas Setup
Initial S/W Revision	A.13.50

## V-network

This key enables you to select the V-network that is controlled via the AUX IO port in a final measurement.

Key Path	Meas Setup, LISN Control
<b>Remote Command</b>	:SENSe1 SENSe2 [SENSe]:FMEasurement:LISN[:TYPE] FOURphase   ESH2Z5   ENV216   OFF  :SENSe1 SENSe2 [SENSe]:FMEasurement:LISN[:TYPE]?
<b>Example</b>	FME:LISN FOUR
Notes	FOURPhase and ESH2-Z5: R&S ESH2-Z5 (four phases and protective earth are controllable) ENV216: R&S ENV216 (two phases and highpass are controllable) OFF: Remote control deactivated
Dependencies	This key is grayed out when a scan sequence is running. If the grayed out key is pressed, an advisory message is generated. If the equivalent SCPI command is sent, this same message is generated as part of a “-221, Settings conflict” warning.
Preset	OFF
State Saved	Saved in instrument state
Initial S/W Revision	A.13.50



## Settings

This menu enables you to access the LISN control menu.

Key Path	Meas Setup, LISN Control
ReadBack	[<Phase>, <HighPass>, <ProtectiveEarth>] in the format of [N L1 L2 L3,HP,GRO FLO] HP would be shown when the 150KHz HighPass is turn on. GRO stands for is for grounded and FLO stands for floating.
Initial S/W Revision	A.13.50

## Phase

Selects the phases of the V-network.

Key Path	Meas Setup, LISN Control, Settings
<b>Remote Command</b>	:SENSe1 SENSe2 [SENSe]:FMEasurement:LISN:PHASe L1   L2   L3   N[ [,L1   L2   L3   N], . ] :SENSe1 SENSe2 [SENSe]:FMEasurement:LISN:PHASe L1   L2   L3   N[ [,L1   L2   L3   N], . ]
<b>Example</b>	FME:LISN:PHAS L1
Notes	L2 and L3 are only available in ESH2Z5 (or set to FOURphase)
Dependencies	Phase N L1 L2 L3 are grayed out with OFF whereas Phase L2 L3 are grayed out with ENV216. If the grayed out key is pressed, an advisory message is generated. If the equivalent SCPI command is sent, this same message is generated as part of a “-221, Setting Conflict; Function not available with current LISN Type” warning. This key is grayed out when a scan sequence is running. If the grayed out key is pressed, an advisory message is generated. If the equivalent SCPI command is sent, this same message is generated as part of a “-221, Settings conflict” warning.
Couplings	If users try to turn off all available phases from front panel, an advisory message is generated as “At least one Phase must be turned on”.
Preset	ON
State Saved	Saved in instrument state
Range	ON OFF ON is selected when the specific phase is selected. User can select different phase at the same time.
Initial S/W Revision	A.13.50

## 150 kHz Highpass

Toggles highpass of the V-network.

Key Path	Meas Setup, LISN Control, Settings
<b>Remote Command</b>	:SENSe1 SENSe2 [:SENSe]:FMEasurement:LISN:FILTeR:HPAS[:StAtE] ON   OFF   1   0

	:SENSe1 SENSe2 [:SENSe]:FMEasurement:LISN:FILTer:HPAS[:STAtE]?
<b>Example</b>	:FME:LISN:FILT:HPAS ON
Notes	This key is only available when ENV216 V-network is selected.
Dependencies	This key is grayed out when V-network other than ENV216 is selected. If the grayed out key is pressed, an advisory message is generated. If the equivalent SCPI command is sent, this same message is generated as part of a “-221, Setting Conflict; Function not available with current LISN Type” warning.
Couplings	This key is coupled to 150kHz Highpass of LISN Control in Mode Setup panel, and vice versa.
Preset	OFF
State Saved	Saved in instrument state
Range	ON OFF
Initial S/W Revision	A.13.50

### Protective Earth

Selects the ground settings of the V-network.

Key Path	Meas Setup, LISN Control, Settings
<b>Remote Command</b>	:SENSe1 SENSe2 [:SENSe]:FMEasurement:LISN:PEARth GROunded   FLOating, [GROunded   FLOating] :SENSe1 SENSe2 [:SENSe]:FMEasurement:LISN:PEARth?
<b>Example</b>	:FME:LISN:PEAR GRO,FLO
Notes	This key is only available when ESH2Z5 V-network is selected.
Dependencies	This key is grayed out V-networks other than ESH2Z5 is selected. If the equivalent SCPI command is sent, this same message is generated as part of a “-221, Setting Conflict; Function not available with current LISN Type” warning.
Couplings	If users try to turn off both protective earth from front panel, an advisory message is generated as “At least one Protective Earth must be turned on”.
Preset	Grounded
State Saved	Saved in instrument state
Range	GRO FLO
Initial S/W Revision	A.13.50

### Meas Preset

Returns the measurement local variables in the current measurement to their preset values.

<b>Remote Command</b>	:CONFIgure:FSCan
<b>Example</b>	CONF:FSC
Initial S/W Revision	A.07.00

### Mark Signal (Remote Command Only)

Marks signals based on the selected parameter, either current, duplicate or all.

<b>Remote Command</b>	:CALCulate:EMI:SLIS:MARK CURRent DUPLicate ALL
<b>Example</b>	CALC:EMI:SLIS:MARK DUPL Marks duplicated signals.
<b>Notes</b>	CURRent aliases to :CALC:FSC:SLIS:MARK <integer> where integer is the currently selected signal. DUPLicate aliases to :CALC:FSC:SLIS:MARK:DUPL ALL aliases to :CALC:FSC:SLIS:MARK:ALL
<b>Initial S/W Revision</b>	A.07.00

### Clear Mark (Remote Command Only)

Clears marks on all or the current signal.

<b>Remote Command</b>	:CALCulate:EMI:SLIS:CLEAr ALL CURRent
<b>Example</b>	CALC:EMI:SLIS:CLE ALL Clear mark from all signals.
<b>Notes</b>	ALL aliases to :CALC:FSC:SLIS:CLE:ALL CURRent aliases to :CALC:FSC:SLIS:CLE <integer> where integer is the currently selected signal.
<b>Initial S/W Revision</b>	A.07.00

### Delete Signal (Remote Command Only)

Deletes a signal in the signal list.

<b>Remote Command</b>	:CALCulate:EMI:SLIS:DELeTe ALL CURRent MARKed UNMarked
<b>Example</b>	CALC:EMI:SLIS:DEL ALL Delete all signals.
<b>Notes</b>	ALL aliases to :CALC:FSC:SLIS:DEL:ALL CURRent aliases to :CALC:FSC:SLIS:DEL <int> where integer is the selected signal MARKed aliases to :CALC:FSC:SLIS:DEL:MARK UNMarked aliases to :CALC:FSC:SLIS:DEL:UNM
<b>Initial S/W Revision</b>	A.07.00

### Range Count (Remote Command Only)

This command specifies the number of ranges to turn on beginning with range 1 in ascending order.

<b>Remote Command</b>	[ :SENSe ] :SCAN:RANGes [ :COUNT ] <integer> [ :SENSe ] :SCAN:RANGes [ :COUNT ] ?
<b>Example</b>	SCAN:RANG 4 Turn on Range 1 to 4.
<b>Notes</b>	This command is included for ESU compatibility. The suffix [1]2 is irrelevant to the measurement,

	they are added solely for remote language compatibility.
Dependencies	This function is not available when a scan sequence is running. If the SCPI command is sent, the message is generated as part of a “-221, Settings conflict” warning.
Couplings	When 0, all ranges will be turned off.
Preset	1
Min	0
Max	10
<b>Backwards Compatibility SCPI</b>	SENSe1   SENSe2 :SCAN:RANGes [ :COUNT ]
Initial S/W Revision	A.07.00

### Final Measurement (Remote Command Only)

This command performs a Final Measurement for all signals in the peak list.

<b>Remote Command</b>	INITiate [1]   2 :FMEasurement
<b>Example</b>	INIT:FME
Notes	This command above is included for ESU compatibility. The suffix [1]2 is irrelevant to the measurement, they are added solely for remote language compatibility. This command is alias to :FSC:SEQ:REM ALL; :FSC:SEQ REM; :INIT.
Dependencies	This key is grayed out when a scan sequence is running. If the grayed out key is pressed, an advisory message is generated. If the equivalent SCPI command is sent, this same message is generated as part of a “-221, Settings conflict” warning.
Initial S/W Revision	A.07.00

### Search Method (Remote Command Only)

This command defines the search method with which maxima are searched for within a scan.

<b>Remote Command</b>	CALCulate [1]   2 :PEAKsearch   PSEarch:METHOD SUBRange   PEAK CALCulate [1]   2 :PEAKsearch   PSEarch:METHOD
<b>Example</b>	CALC:PEAK:METH SUBR Selects subrange method.
Notes	SUBRange aliases to :FSCan:SEARch:MODE SLIM; CALC:FSC:MARK:PEAK:SEAR:MODE MAX, which actually set Search Criteria = “Subrange and Limits” and Peak Criteria = “Highest Peak”. PEAK aliases to :FSCan:SEARch:MODE PLIM; CALC:FSC:MARK:PEAK:SEAR:MODE MAX; FSC:SEAR:PEAK:COUN:STAT OFF, which actually set Search Criteria = “Peak Criteria and Limits”, Peak Criteria = “Highest Peak” and # of Peaks State = ON.
Initial S/W Revision	A.11.00

## No of Peaks (Remote Command Only)

This command defines the number of subranges or peaks for the determination of the peak list.

<b>Remote Command</b>	CALCulate[1] 2:PEAKsearch PSEarch:SUBRanges <integer> CALCulate[1] 2:PEAKsearch PSEarch:SUBRanges?
<b>Example</b>	CALC:PEAK:SUBR 10 CALC:PEAK:SUBR?
<b>Notes</b>	This command is alias to FSC:SEAR:PEAK:COUN; FSC:SEAR:SUBR:COUN, which actually set # of peaks and # of subranges.
<b>Preset</b>	25
<b>Min</b>	1
<b>Max</b>	500
<b>Initial S/W Revision</b>	A.11.00

## Insert Signal (Remote Command Only)

This command adds a frequency value to the signal list. Only frequencies in the currently displayed frequency range of the receiver scan are allowed.

<b>Remote Command</b>	CALCulate[1] 2:PEAKsearch PSEarch:ADD <Numeric Value>
<b>Example</b>	CALC:PEAK:ADD 13MHz Add 13MHz to the signal list.
<b>Notes</b>	When this command is sent, # of peaks State will be set to ON, this is equivalent to FSC:SEAR:PEAK:COUN:STAT ON command.
<b>Initial S/W Revision</b>	A.11.00

## Clear All Signals (Remote Command Only)

This command clears all peaks in signal list.

<b>Remote Command</b>	CALCulate[1] 2:PEAKsearch PSEarch:CLEar[:IMMediate]
<b>Example</b>	CALC:PEAK:CLE
<b>Notes</b>	This command is alias to FSC:SEAR:PEAK:COUN:STAT; CALC:FSC:SLIS:DEL:ALL, which actually set # of peaks State = ON and delete all signals.
<b>Initial S/W Revision</b>	A.11.00

8 Frequency Scan Measurement  
Mode

Mode

See "[Mode](#)" on page 222

## Mode Preset

Returns the active mode to a known state.

Mode Preset does the following for the currently active mode:

- Aborts the currently running measurement.
- Brings up the default menu for the mode, with no active function.
- Sets measurement Global settings to their preset values for the active mode only.
- Activates the default measurement.
- Brings up the default menu for the mode.
- Clears the input and output buffers.
- Sets Status Byte to 0.

Mode Preset does not:

- Cause a mode switch
- Affect mode persistent settings
- Affect system settings

See "[How-To Preset](#)" on page 512 for more information.

Key Path	Front-panel key
<b>Remote Command</b>	:SYSTem:PRESet
<b>Example</b>	:SYST:PRES
Notes	*RST is preferred over :SYST:PRES for remote operation. *RST does a Mode Preset, as done by the :SYST:PRES command, and it sets the measurement mode to Single measurement rather than Continuous for optimal remote control throughput. Clears all pending OPC bits. The Status Byte is set to 0.
Couplings	A Mode Preset aborts the currently running measurement, activates the default measurement, and gets the mode to a consistent state with all of the default couplings set.
Backwards Compatibility Notes	In the X-Series, the legacy "Factory Preset" has been replaced with Mode Preset, which only presets the currently active mode, not the entire instrument. In the X-Series, the way to preset the entire instrument is by using System, Restore System Defaults All, which behaves essentially the same way as restore System Defaults does on ESA and PSA. There is also no "Preset Type" as there is on the PSA. There is a green Mode Preset front-panel key that does a Mode Preset and a white-with-green-letters User Preset front-panel key that does a User Preset. The old PRESet:TYPE command is ignored (without generating an error), and SYST:PRES without a parameter does a Mode Preset, which should cover most backward code compatibility issues. The settings and correction data under the Input/Output front-panel key (examples: Input Z Corr, Ext Amp Gain, etc.) are no longer part of any Mode, so they will not be preset by a Mode Preset. They are preset using Restore Input/Output Defaults, Restore System Defaults All. Note that because User Preset does a Recall State, and all of these settings are saved in State, they ARE recalled when using

	User Preset.
Initial S/W Revision	Prior to A.02.00

## How-To Preset

The table below shows all possible presets, their corresponding SCPI commands and front-panel access (key paths). Instrument settings depend on the current measurement context. Some settings are local to the current measurement, some are global (common) across all the measurements in the current mode, and some are global to all the available modes. In a similar way, restoring the settings to their preset state can be done within the different contexts.

Auto Couple - is a measurement local key. It sets all Auto/Man parameter couplings in the measurement to Auto. Any Auto/Man selection that is local to other measurements in the mode will not be affected.

Meas Preset - is a measurement local key. Meas Preset resets all the variables local to the current measurement except the persistent ones.

Mode Preset - resets all the current mode's measurement local and measurement global variables except the persistent ones.

Restore Mode Defaults - resets ALL the Mode variables (and all the Meas global and Meas local variables), including the persistent ones.

Type Of Preset	SCPI Command	Front Panel Access
Auto Couple	:COUPle ALL	Auto Couple front-panel key
Meas Preset	:CONFigure:<Measurement>	Meas Setup Menu
Mode Preset	:SYSTem:PRESet	Mode Preset (green key)
Restore Mode Defaults	:INSTrument:DEFault	Mode Setup Menu
Restore All Mode Defaults	:SYSTem:DEFault MODes	System Menu; Restore System Default Menu
*RST	*RST	not possible (Mode Preset with Single)
Restore Input/Output Defaults	:SYSTem:DEFault INPUt	System Menu; Restore System Default Menu
Restore Power On Defaults	:SYSTem:DEFault PON	System Menu; Restore System Default Menu
Restore Alignment Defaults	:SYSTem:DEFault ALIGN	System Menu; Restore System Default Menu
Restore Miscellaneous Defaults	:SYSTem:DEFault MISC	System Menu; Restore System Default Menu
Restore All System Defaults	:SYSTem:DEFault [ALL] :SYSTem:PRESet:PERsistent	System Menu; Restore System Default Menu
User Preset	:SYSTem:PRESet:USER	User Preset Menu
User Preset All Modes	:SYSTem:PRESet:USER:ALL	User Preset Menu



Power On Mode Preset	:SYSTem:PON:TYPE MODE	System Menu
Power On User Preset	:SYSTem:PON:TYPE USER	System Menu
Power On Last State	:SYSTem:PON:TYPE LAST	System Menu

## Mode Setup

See "[Mode Setup](#)" on page 246

## Peak Search

Accesses Peak Search settings and performs a peak search. If no peak is found, an error is generated and this function cannot be performed.

Key Path	Front-panel key
Remote Command	:CALCulate:FSCan:MARKer[1] 2 ... 12:MAXimum
Example	CALC:FSC:MARK2:MAX Performs a peak search using marker 2. CALC:FSC:MARK2:Y? Queries the marker amplitude (Y-axis) value for marker 2. CALC:FSC:MARK2:X? Queries the marker frequency or time (X-axis) value for marker 2. SYST:ERR? Queries the errors to determine if a peak is found. The error -200 will be returned after an unsuccessful search.
Notes	Sending this command selects the subopcoded marker.
Initial S/W Revision	A.07.00

### Next Peak

Moves the selected marker to the peak that has the next highest amplitude that is less than the marker's current value. Only peaks that meet all enabled peak criteria are considered (See "[Peak Criteria](#)" on page 516). If there is no valid peak lower than the current marker position, an error is generated and the marker is not moved. S

If the selected marker was off, then it is turned on as a normal marker and a peak search is performed.

Key Path	Peak Search
Remote Command	:CALCulate:FSCan:MARKer[1] 2 ... 12:MAXimum:NEXT
Example	CALC:FSC:MARK2:MAX:NEXT Selects marker 2 and moves it to the peak that is closest in amplitude to the current peak, but the next lower value.
Notes	Sending this command selects the subopcoded marker
Initial S/W Revision	A.07.00

### Next Peak Right

Moves the selected marker to the nearest peak to the right of the current marker that meets all enabled peak criteria. If there is no valid peak to the right of the current marker position, an error is generated and the marker is not moved.

If the selected marker was off, then it is turned on as a normal marker and a peak search is performed.

Key Path	Peak Search
Remote Command	:CALCulate:FSCan:MARKer[1] 2 ... 12:MAXimum:RIGHT
Example	CALC:FSC:MARK2:MAX:RIGH
Initial S/W Revision	A.07.00

### Next Peak Left

Moves the selected marker to the nearest peak to the left of the current marker that meets all enabled peak criteria. If there is no valid peak to the left of the current marker position, an error is generated and the marker is not moved.

If the selected marker was off, then it is turned on as a normal marker and a peak search is performed.

Key Path	Peak Search
<b>Remote Command</b>	:CALCulate:FSCan:MARKer[1] 2 ... 12:MAXimum:LEFT
<b>Example</b>	CALC:FSC:MARK2:MAX:LEFT
Initial S/W Revision	A.07.00

### Min Search

Moves the selected marker to the minimum y-axis value on the current trace. Minimum (negative) peak searches do not have to meet the peak search criteria. It just looks for the lowest y-axis value. If the selected marker is Off, it is turned on before the minimum search is performed.

Key Path	Peak Search
<b>Remote Command</b>	:CALCulate:FSCan:MARKer[1] 2 ... 12:MINimum
<b>Example</b>	CALC:FSC:MARK:MIN selects marker 1 and moves it to the minimum amplitude value.
Notes	Sending this command selects the subopcoded marker
Initial S/W Revision	A.07.00

### Peak Criteria

Pressing this key opens the Peak Criteria menu and allows you to adjust the Pk Threshold and Pk Excursion parameters used for peak search functions.

For a signal to be identified as a peak it must meet certain criteria. Signals in the negative frequency range and signals very close to 0 Hz are ignored. If either the peak excursion or peak threshold functions are on, then the signal must satisfy those criteria before being identified as a peak.

When peak excursion and peak threshold are both off:

- Peak Search, Continuous Peak Search, and maximum part of Pk-Pk Search will search the trace for the point with the highest y-axis value that does not violate the LO feedthrough rules. A rising and falling slope are not required for these three peak search functions.
- The remaining search functions Next Peak, Next Pk Right, etc. will only consider trace points that have a rising and falling slope on the left and right respectively.

Key Path	Peak Search
State Saved	Saved in instrument state.
Initial S/W Revision	A.07.00

## Peak Search Criteria

This menu lets you decide the mode of Peak Search. When Highest Peak is selected, pressing Peak Search finds the highest peak on the marker's trace. If Same as "Next Peak" Criteria is selected, then the search is also forced to consider the Excursion and Threshold found under the "Next Peak" Criteria menu.

Key Path	Peak Search, Peak Criteria
Remote Command	:CALCulate:FSCan:MARKer:PEAK:SEARch:MODE MAXimum PARAmeter :CALCulate:FSCan:MARKer:PEAK:SEARch:MODE?
Example	CALC:FSC:MARK:PEAK:SEAR:MODE MAX
Notes	MAXimum corresponds to the Highest Peak setting PARAmeter corresponds to the Same as "Next Peak" Criteria setting
Preset	MAXimum
State Saved	Saved in instrument state.
Range	Highest Peak  Same as "Next Peak" Criteria (Exc & Threshold)
Readback Text	Current state
Initial S/W Revision	A.07.00

## Highest Peak

When this key is selected, pressing the Peak Search key or issuing the equivalent remote command finds the maximum point on the trace, subject to the peak-search qualifications.

Key Path	Peak Search, Peak Criteria, "Peak Search" Criteria
Example	CALC:FSC:MARK:PEAK:SEAR:MODE MAX
Readback Text	Highest Peak
Initial S/W Revision	A.07.00

## Same as "Next Peak" Criteria

When this key is selected, pressing the Peak Search key or issuing the equivalent remote command finds the maximum point on the trace, but subject to the Excursion and Threshold set under the Next Peak Criteria menu. The search is also subject to the peak-search qualifications. This also affects the Continuous Peak Search.

Key Path	Peak Search, Peak Criteria, "Peak Search" Criteria
Example	CALC:FSC:MARK:PEAK:SEAR:MODE PAR
Readback Text	Same as Next Pk
Initial S/W Revision	A.07.00

## Next Peak Criteria

This key opens a menu that allows you to independently set the Peak Excursion and Peak Threshold and turn them on and off.

Key Path	Peak Search, Peak Criteria
Initial S/W Revision	A.07.00

## Pk Excursion On/Off

Turns the peak excursion requirement on/off and sets the excursion value. The value defines the minimum amplitude variation (rise and fall) required for a signal to be identified as peak. For example, if a value of 6 dB is selected, peak search functions like the marker Next Pk Right function move only to peaks that rise and fall 6 dB or more.

When both Pk Excursion and Pk Threshold are on, a signal must rise above the Pk Threshold value by at least the Peak Excursion value and then fall back from its local maximum by at least the Peak Excursion value to be considered a peak.

Note that in the event that a sequence of trace points with precisely the same values represents the maximum, the leftmost point is found.

Key Path	Peak Search, Next Peak Criteria
<b>Remote Command</b>	:CALCulate:FSCan:MARKer:PEAK:EXCursion <rel_ampl> :CALCulate:FSCan:MARKer:PEAK:EXCursion? :CALCulate:FSCan:MARKer:PEAK:EXCursion:STATe ON OFF 1 0 :CALCulate:FSCan:MARKer:PEAK:EXCursion:STATe?
<b>Example</b>	CALC:FSC:MARK:PEAK:EXC:STAT ON CALC:FSC:MARK:PEAK:EXC 30 DB Sets the minimum peak excursion requirement to 30 dB.
Couplings	Whenever you adjust the value of Pk Excursion (with the knob, step keys, or by completing a numeric entry), and Peak Threshold is turned ON, the Peak Threshold Line and the Peak Excursion Region are displayed. See Section " <a href="#">Pk Threshold Line On/Off</a> " on page 519.
Preset	6.0 dB ON
State Saved	Saved in instrument state.
Min	0.0 dB
Max	100.0 dB
Default Unit	dB
Initial S/W Revision	A.07.00

### Pk Threshold On/Off

Turns the peak threshold requirement on/off and sets the threshold value. The peak threshold value defines the minimum signal level (or min threshold) that the peak identification algorithm uses to recognize a peak.

When both Pk Excursion and Pk Threshold are on, a signal must rise above the Pk Threshold value by at least the Peak Excursion value and then fall back from its local maximum by at least the Peak Excursion value to be considered a peak.

Key Path	Peak Search, Next Peak Criteria
Remote Command	:CALCulate:FSCan:MARKer:PEAK:THReshold <ampl> :CALCulate:FSCan:MARKer:PEAK:THReshold? :CALCulate:FSCan:MARKer:PEAK:THReshold:STATe ON OFF 1 0 :CALCulate:FSCan:MARKer:PEAK:THReshold:STATe?
Example	CALC:FSC:MARK:PEAK:THR:STAT ON Turns on the threshold criterion. CALC:FSC:MARK:PEAK:THR -60 dBm Sets the threshold to -60 dBm.
Couplings	When Ref Level Offset changes, Peak Threshold must change by the same amount. Whenever you adjust the value of Pk Excursion (with the knob, step keys, or by completing a numeric entry), and Peak Threshold is turned ON, the Peak Threshold Line and the Peak Excursion Region are displayed
Preset	-90.0 dBm ON
State Saved	Saved in instrument state.
Min	-200 dBm
Max	+0 dBm
Default Unit	Depends on the current selected Y axis unit
Initial S/W Revision	A.07.00

### Pk Threshold Line On/Off

Turns the peak threshold line on or off.

Key Path	Peak Search, Next Peak Criteria
Notes	Front panel only.
Couplings	If Peak Threshold is Off and the Peak Threshold line is turned on, it should turn on Peak Threshold.
Preset	OFF
State Saved	Saved in instrument state.
Initial S/W Revision	A.07.00

8 Frequency Scan Measurement  
Print

Print

See "Print" on page 271



## Quick Save

The Quick Save front-panel key repeats the most recent save that was performed from the Save menu, with the following exceptions:

- Register saves are not remembered as Saves for the purpose of the Quick Save function
- If the current measurement does not support the last non-register save that was performed, an informational message is generated, “File type not supported for this measurement”

Quick Save repeats the last type of qualified save (that is, a save qualified by the above criteria) in the last save directory by creating a unique filename using the Auto File Naming algorithm described below.

If Quick Save is pressed after startup and before any qualified Save has been performed, the Quick Save function performs a Screen Image save using the current settings for Screen Image saves (current theme, current directory), which then becomes the “last save” for the purpose of subsequent Quick Saves.

The Auto File Naming feature automatically generates a file name for use when saving a file. The filename consists of a prefix and suffix separated by a dot, as is standard for the Windows® file system. A default prefix exists for each of the available file types:

Type	Default Prefix	Menu
State	State_	(Save/Recall)
Trace + State	State_	(Save/Recall)
Screen	Screen_	(Save/Recall)
Amplitude Corrections	Ampcor_	(Import/Export)
Traces	Trace_	(Import/Export)
Limit Lines	LLine_	(Import/Export)
Measurement Result	MeasR_	(Import/Export)
Capture Buffer	CapBuf_	(Import/Export)

A four digit number is appended to the prefix to create a unique file name. The numbering sequence starts at 0000 within each Mode for each file type and updates incrementally to 9999, then wraps to 0000 again. It remembers where it was through a Mode Preset and when leaving and returning to the Mode. It is reset by Restore Misc Defaults and Restore System Defaults and subsequent running of the instrument application. So, for example, the first auto file name generated for State files is State\_0000.state. The next is State\_0001, and so forth.

One of the key features of Auto File Name is that we guarantee that the Auto File Name will never conflict with an existing file. The algorithm looks for the next available number. If it gets to 9999, then it looks for holes. If it find no holes, that is no more numbers are available, it gives an error.

For example, if when we get to State\_0010.state there is already a State\_0010.state file in the current directory, it advances the counter to State\_0011.state to ensure that no conflict will exist (and then it verifies that State\_0011.state also does not exist in the current directory and advances again if it does, and so forth).

If you enter a file name for a given file type, then the prefix becomes the filename you entered instead of the default prefix, followed by an underscore. The last four letters (the suffix) are the 4-digit number.

For example, if you save a measurement results file as “fred.csv”, then the next auto file name chosen for a measurement results save will be fred\_0000.csv.

**NOTE**

Although 0000 is used in the example above, the number that is used is actually the current number in the Meas Results sequence, that is, the number that would have been used if you had not entered your own file name.

---

**NOTE**

If the filename you entered ends with \_dddd, where d=any number, making it look just like an auto file name, then the next auto file name picks up where you left off with the suffix being dddd + 1.

---

Key Path	Front-panel key
Notes	No remote command for this key specifically.
Initial S/W Revision	Prior to A.02.00

## Recall

The recall key accesses the menu that allows you to load a measurement state and data from external files or registers.

Key Path	Front-panel key
Initial S/W Revision	A.07.00

## State

The Recall State menu lets you choose a register or file from which to recall the state.

The content of a state file includes all of the settings and data required to return the analyzer as closely as possible to the Mode it was in, with the exact settings that were in place, when the save occurred. The Mode settings in each state file include the settings that are affected by Mode Preset, as well as the additional settings affected by Restore Mode Defaults; all of the Mode's settings. In addition, all of the settings of the Input/Output system are included, even though they are outside of the Mode's state, because they are needed to restore the complete setup. Persistent System settings (for example, GPIB address) are not affected by either a Mode Preset or Restore Mode Defaults, nor are they included in a saved State file.

Since each state file is only for one Mode, the settings for other Modes are unaffected when it is loaded. Recall State will cause a mode switch if the state being recalled is not from the current active mode.

After the recall completes, the message "File <filename> recalled" or "Recalled State Register <register number>" is displayed.

For rapid recalls, the State menu lists 16 registers that you can choose from to recall. Pressing a Register key initiates the recall. You can also select a file from which to recall.

The default path for all State Files is:

My Documents\`<mode name>`\state

where `<mode name>` is the parameter used to select the mode with the INST:SEL command (for example, SA for the Spectrum Analyzer).

See ["More Information" on page 524](#).

Key Path	Recall
Mode	All
<b>Remote Command</b>	:MMEMory:LOAD:STATe <filename>
<b>Example</b>	:MMEM:LOAD:STAT "myState.state" This recalls the file myState.state on the default path
<b>Example</b>	MMEM:LOAD:STAT "MyStateFile.state" This loads the state file data (on the default file directory path) into the instrument state.
Notes	When you pick a file to recall, the analyzer first verifies that the file is recallable in the current instrument by checking the software version and model number of the instrument. If everything

matches, a full recall proceeds by aborting the currently running measurement, clearing any pending operations, and then loading the State from the saved state file. You can open state files from any mode, so recalling a State file switches to the mode that was active when the save occurred. After switching to the mode of the saved state file, mode settings and data (if any for the mode) are loaded with values from the saved file. The saved measurement of the mode becomes the newly active measurement and the data relevant to the measurement (if there is any) is recalled.

If there is a mismatch between file version or model number or instrument version or model number, the recall function tries to recall as much as possible and returns a warning message. It may limit settings that differ based on model number, licensing or version number.

After recalling the state, the Recall State function does the following:

- Makes the saved measurement for the mode the active measurement.
- Clears the input and output buffers.
- Status Byte is set to 0.
- Executes a \*CLS

If the file specified is empty an error is generated. If the specified file does not exist, another error is generated. If there is a mismatch between the file and the proper file type, an error is generated. If there is a mismatch between file version or model number or instrument version or model number, a warning is displayed. Then it returns to the State menu and File Open dialog goes away.

After the Recall, the analyzer exits the Recall menu and returns to the previous menu.

<b>Backwards Compatibility SCPI</b>	:MMEMory:LOAD:STATe 1,<filename>
Initial S/W Revision	Prior to A.02.00

## More Information

In measurements that support saving Traces, for example, Swept SA, the Trace data is saved along with the State in the State file. When recalling the State, the Trace data is recalled as well. Traces are recalled exactly as they were stored, including the writing mode and update and display modes. If a Trace was updating and visible when the State was saved, it will come back updating and visible, and its data will be rewritten right away. When you use State to save and recall traces, any trace whose data must be preserved should be placed in View or Blank mode before saving.

The following table describes the Trace Save and Recall possibilities:

You want to recall state and one trace's data, leaving other traces unaffected.	Save Trace+State from 1 trace. Make sure that no other traces are updating (they should all be in View or Blank mode) when the save is performed.	On Recall, specify the trace you want to load the one trace's data into. This trace will load in View. All other traces' data will be unaffected, although their trace mode will be as it was when the state save was performed.
You want to recall all traces	Save Trace+State from ALL traces.	On Recall, all traces will come back in View (or Blank if they were in Blank or Background when saved)

You want all traces to load exactly as they were when saved.

Save State

On recall, all traces' mode and data will be exactly as they were when saved. Any traces that were updating will have their data immediately overwritten.

## From File...

When you press “From File”, the analyzer brings up a Windows dialog and a menu entitled “File Open.” This menu allows you to navigate to the various fields in the Windows dialog without using a keyboard or mouse. The Tab and Arrow keys can also be used for dialog navigation.

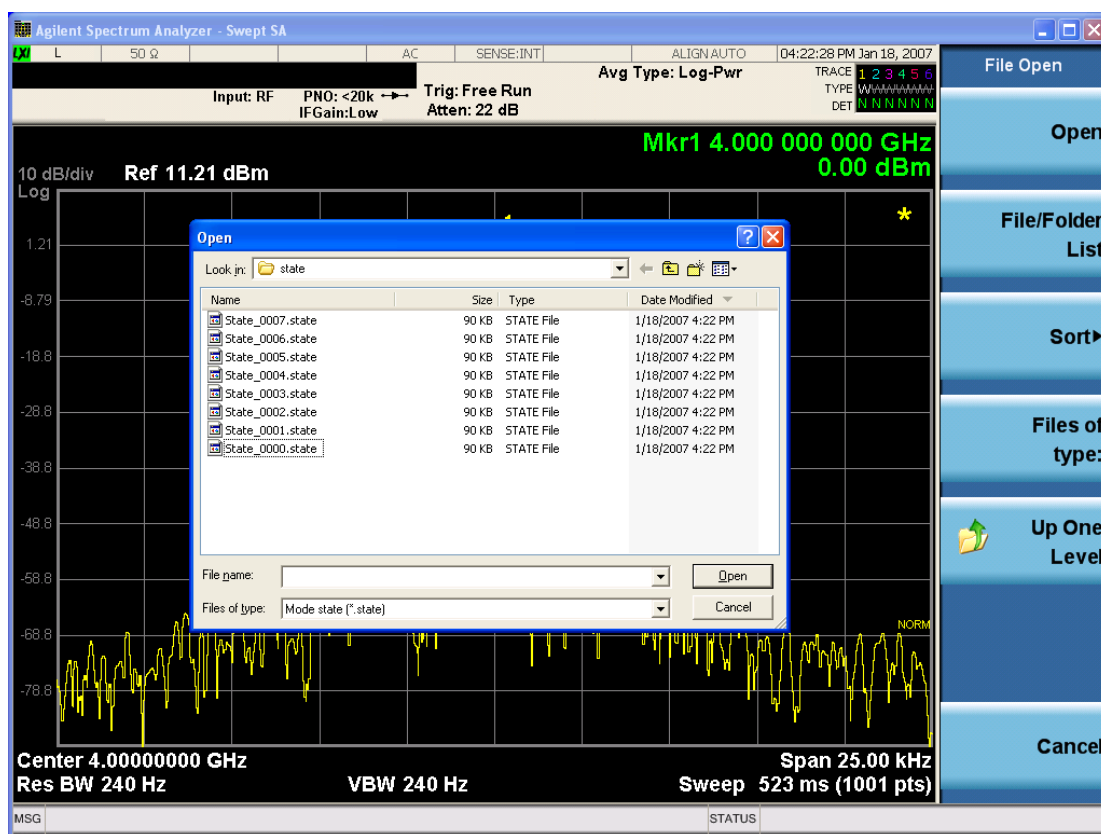

Listed below are the functions of the various fields in the dialog, and the corresponding softkeys:

### Open

Performs the recall of the specified file. While the recall is being performed, the floppy icon appears briefly in the Meas bar.

### File/Folder List

Enables you to navigate to the center of the dialog that contains the list of files and folders. Once here you can get information about the file and use the tab keys to navigate to the other fields in the dialog, such as Look In.

### Look In

The Look In field shows the path from which the file will be recalled and allows you to change the path using the up and down arrow keys to navigate to other paths; the Enter key to open a directory; and the Backspace key to go back one directory. The **Look In field** first uses the last path from the Save As dialog **Save In:** path for that same file type. There is no softkey for directly navigating to the Look In field, but you can use the left tab to get here from the File/Folder List.

User specified paths are remembered when you leave and return to a Mode and are reset back to the default using Restore Mode Defaults.

### Sort

Accesses a menu that enables you to sort the files within the File Open dialog. Only one sorting type can be selected at a time and the sorting happens immediately. The sorting types are By Date, By Name, By extension, and By Size.

### Files of Type

This field shows the file suffix for the type of file you have selected to recall. For example, if you navigated here while recalling State, "Mode state (\*.state)" is in the field. If you navigated here while recalling Trace, ""Mode state (\*.trace)" is in the field. If you navigated here while importing a trace data file, "Trace Data (\*.csv)" is in the field. For some file types, there is more than one choice in the dropdown menu, which you can select by using the up and down arrow keys and Enter.

### Up One Level

This key corresponds to the icon of a folder with the up arrow that is in the tool bar of the dialog. When pressed, it causes the file and folder list to navigate up one level in the directory structure. The Backspace key does the same thing.

### Cancel

This key corresponds to the Cancel selection in the dialog. It causes the current **Open** request to be cancelled. The ESC key does the same thing.

Key Path	Recall, State
Notes	Brings up the Open dialog for recalling a State Save Type
Initial S/W Revision	Prior to A.02.00

## Edit Register Names

You may enter a custom name on any of the Register keys, to help you remember what you are using that state to save. To do this, press the Edit Register Names key, choose the register whose name you wish to edit, and then enter the desired label using the Alpha Editor or an external PC keyboard.

The maximum number of characters that can be added is 30. In most cases, 30 characters will fit on two lines of the key.

For more information and the SCPI command, see Edit Register Names under the Save, State function.

Key Path	Recall, State
Mode	All
Dependencies	N9060A-7FP or N9060B-2FP license required to edit the register names. When the feature is not licensed, sending the SCPI command generates an error, -221, "Settings conflict;Option not available"
Initial S/W Revision	A.11.00

### Register 1 thru Register 16

Selecting any one of these register keys causes the State of the mode from the specified Register to be recalled. Each of the register keys annotates whether it is empty or at what date and time it was last modified. In addition, you can use the Edit Register Names key under Save, State to enter custom names for each register.

Registers are shared by all modes, so recalling from any one of the registers will cause a mode switch to the mode that was active when the save to the Register occurred.

Although these 16 registers are the only registers available from the front panel, there are 128 state registers available in the instrument. Registers 17–128 are only available from the SCPI interface, using the \*RCL command.

After the recall completes, the message "Register <register number> recalled" appears in the message bar. If you are in the Spectrum Analyzer Mode, and you are recalling a register that was saved in the Spectrum Analyzer Mode, then after the recall, you will still be in the Recall Register menu. If the Recall causes you to switch modes, then after the Recall, you will be in the Frequency menu.

If a requested register is empty an error is generated.

Key Path	Recall, State
<b>Example</b>	*RCL 1
Range	1-16 from front panel, 1-128 from SCPI
Readback	Date and time with seconds resolution are displayed on the key OR A custom name of up to 30 characters entered using the Save, State,Edit Register Names key OR “(empty)” if no prior save operation has been performed to this register.
Initial S/W Revision	Prior to A.02.00
Modified at S/W Revision	Prior to A.11.00

### Register 1 thru Register 16

Selecting any one of these register keys causes the State of the mode from the specified Register to be recalled. Each of the register keys annotates whether it is empty or at what date and time it was last

modified. In addition, you can use the Edit Register Names key under Save, State to enter custom names for each register.

Registers are shared by all modes, so recalling from any one of the registers will cause a mode switch to the mode that was active when the save to the Register occurred.

Although these 16 registers are the only registers available from the front panel, there are 128 state registers available in the instrument. Registers 17–128 are only available from the SCPI interface, using the \*RCL command.

After the recall completes, the message "Register <register number> recalled" appears in the message bar. If you are in the Spectrum Analyzer Mode, and you are recalling a register that was saved in the Spectrum Analyzer Mode, then after the recall, you will still be in the Recall Register menu. If the Recall causes you to switch modes, then after the Recall, you will be in the Frequency menu.

If a requested register is empty an error is generated.

Key Path	Recall, State
Example	*RCL 1
Range	1–16 from front panel, 1–128 from SCPI
Readback	Date and time with seconds resolution are displayed on the key OR A custom name of up to 30 characters entered using the Save, State, Edit Register Names key OR “(empty)” if no prior save operation has been performed to this register.
Initial S/W Revision	Prior to A.02.00
Modified at S/W Revision	Prior to A.11.00

## Data (Import)

Importing a data file loads data that was previously saved from the current measurement or from other measurements and/or modes that produce compatible data files. The Import Menu only contains Data Types that are supported by the current measurement.

Since the commonly exported data files are in .csv format, the data can be edited by the user prior to importing. This allows you to export a data file, manipulate the data in Excel (the most common PC Application for manipulating .csv files) and then import it.

Importing Data loads measurement data from the specified file into the specified or default destination, depending on the data type selected. Selecting an Import Data menu key will not actually cause the importing to occur, since the analyzer still needs to know from where to get the data. Pressing the Open key in this menu brings up the Open dialog and Open menu that provides you with the options from where to recall the data. Once a filename has been selected or entered in the Open menu, the recall occurs as soon as the Open button is pressed.

Key Path	Recall
Mode	All



Notes	The menu is built from whatever data types are available for the mode. Some keys will be missing completely, so the key locations in the sub-menu will vary. No SCPI command directly controls the Data Type that this key controls. The Data Type is included in the MMEM:LOAD commands.
Dependencies	If a file type is not used by a certain measurement, it is grayed out for that measurement. The key for a file type will not show at all if there are no measurements in the Mode that support it.
Preset	Is not affected by Preset or shutdown, but is reset during Restore Mode Defaults
Readback	The data type that is currently selected
Initial S/W Revision	Prior to A.02.00

## Amplitude Correction

This key selects the Amplitude Corrections as the data type to be imported. When pressed a second time, it brings up the Select Menu, which lets you select the Correction into which the data will be imported.

Amplitude Corrections are fully discussed in the documentation of the Input/Output key, under the Corrections key.

A set of preloaded Corrections files can be found in the directory

/My Documents/ EMC Limits and Ampcor.

When the Amplitude Correction is an Antenna correction and the Antenna Unit in the file is not None, the Y Axis Unit setting will change to match the Antenna Unit in the file.

Key Path	Recall
Mode	SA EDGE GSM PN
Remote Command	:MMEMory:LOAD:CORRection 1 2 3 4 5 6 7 8, <filename>
Example	:MMEM:LOAD:CORR 2, "myAmpcor.csv" recalls the Amplitude Correction data from the file myAmpcor.csv in the current directory to the 2nd Amplitude Correction table, and turns on Correction 2. The default path is D:\User_My_Documents\Instrument\My Documents\amplitudeCorrections\
Dependencies	Only the first correction array (Correction 1) supports antenna units. This means that a correction file with an Antenna Unit can only be loaded into the Corrections 1 register. Consequently only for Correction 1 does the dropdown in the Recall dialog include.ant, and if an attempt is made to load a correction file into any other Correction register which DOES contain an antenna unit, a Mass Storage error is generated. Corrections are not supported by all Measurements. If in a Mode in which some Measurements support it, this key will be grayed out in measurements that do not. The key will not show at all if no measurements in the Mode support it. Errors are reported if the file is empty or missing, or if the file type does not match, or if there is a mismatch between the file type and the destination data type. If any of these occur during manual operation, the analyzer returns to the Import Data menu and the File Open dialog goes away. This key does not appear unless you have the proper option installed in your instrument. This command will generate an "Option not available" error unless you have the proper option installed in your instrument.

<b>Couplings</b>	When a correction file is loaded from mass storage, it is automatically turned on ( <b>Correction ON</b> ) and <b>ApplyCorrections</b> is set to On. This allows you to see its effect, thus confirming the load.
<b>Readback</b>	selected Correction
<b>Backwards Compatibility SCPI</b>	:MMEMory:LOAD:CORRection ANTenna   CABLe   OTHer   USER, <filename> For backwards compatibility, ANTenna maps to 1, CABLe maps to 2, OTHer maps to 3 and USER maps to 4
<b>Initial S/W Revision</b>	A.02.00

### Default Directory

Specifies the default directory used for loading of Amplitude Correction. If user is selected, the default recall directory is the default (My Documents\amplitudeCorrections) or the last directory you saved the amplitude correction data to. Otherwise, the default recall directory is My Documents\EMC Limits and Ampcor\Ampcor, which contains a set of preloaded amplitude correction files in the directory called Ampcor.

<b>Key Path</b>	Recall, Export Data, Amplitude Correction
<b>Remote Command</b>	:MMEMory:LOAD:CORRection:DDIRectory USER PRELoaded
<b>Example</b>	:MMEM:LOAD:CORR:DDIR USER Select user :MMEM:LOAD:CORR:DDIR?
<b>Notes</b>	USER = User PRELoaded = Preloaded
<b>Preset</b>	PRELoaded
<b>State Saved</b>	Saved in instrument state.
<b>Range</b>	User  Preloaded
<b>Readback</b>	"User"  "Preloaded"
<b>Initial S/W Revision</b>	A.13.00

### Trace

This key selects Trace as the data type to be imported. When pressed a second time, it brings up the Trace Menu, which lets you select the Trace into which the data will be imported.

The trace file contains "meta" data which describes the state of the analyzer when the trace was exported (see ). If the meta data in the file does not match the current SA state, the "invalid data indicator" (\*) is displayed.

<b>Key Path</b>	Recall, Data
<b>Remote Command</b>	:MMEMory:LOAD:TRACe:DATA TRACE1 TRACE2 TRACE3,<filename>
<b>Example</b>	:MMEM:LOAD:TRAC DATA TRACE2, "myTrace2.csv" imports the 2nd trace from the file

	myTrace2.csv in the current path. The default path is My Documents\EMI\data\xxx\traces where xxx is the measurement name.
Dependencies	A trace cannot be recalled from a trace file that was exported with ALL traces selected. A trace cannot be imported if the number of trace points in the file do not match the number of sweep points currently set for the measurement. If this happens, an error message is generated. Errors are reported if the file is empty or missing, or if the file type does not match, or if there is a mismatch between the file type and the destination data type. If any error occurs while trying to load a file manually (as opposed to during remote operation), the analyzer returns to the Import Data menu and the File Open dialog goes away.
Couplings	When a trace is imported, <b>Trace Update</b> is always turned OFF for that trace and <b>Trace Display</b> is always turned ON.
Readback	1 2 3
Status Bits/OPC dependencies	Sequential - aborts the current measurement.
Initial S/W Revision	Prior to A.02.00

## Limit

This key selects Limit Lines as the data type to be imported. When pressed a second time, it brings up the Limits Menu, which lets you select into which Limit the data will be imported.

Key Path	Recall, Data
Remote Command	:MMEMory:LOAD:LIMit LLINE1   LLINE2   LLINE3   LLINE4   LLINE5   LLINE6,<filename>
Example	:MMEM:LOAD:LIM LLINE2, "myLimitLine2.csv" imports the 2nd Limit Line from the file myLimitLine2.csv in the current path. The default path is depending on the Limit Default Directory selection.
Dependencies	Errors are reported if the file is empty or missing, or if the file type does not match, or if there is a mismatch between the file type and the destination data type. If any of these occur during manual operation, the analyzer returns to the Import Data menu and the File Open dialog goes away. This key will only appear if you have the proper option installed in your instrument.
Couplings	When a limit line is loaded from mass storage, it is automatically turned on. This allows you to see it, thus confirming the load. The Margin settings will match those set when the limit was saved
Readback	1 2 3 4 5 6
Status Bits/OPC dependencies	Sequential - aborts the current measurement
Initial S/W Revision	A.02.00

## Default Directory

Specifies the default directory used for loading of Limit. If user is selected, the default recall directory is the default (My Documents\EMI\data\xxx\Limits where xxx is the measurement name) or the last directory you

saved the limit line data to. Otherwise, the default recall directory is My Documents\EMC Limits and Ampcor\Limits, which contains a set of preloaded limit files.

Key Path	Recall, Export Data, Limit
Remote Command	:MMEMory:LOAD:LIMit:DDIRectory USER PRELoaded
Example	:MMEM:LOAD:LIM:DDIR USER Select user :MMEM:LOAD:LIM:DDIR?
Notes	USER = User PRELoaded = Preloaded
Preset	PRELoaded
State Saved	Saved in instrument state.
Range	User  Preloaded
Readback	"User"  "Preloaded"
Initial S/W Revision	A.13.00

### Signal List

Selects the signal list as the data type to be imported. The next step is to select the Open key in the Import Data menu. If there is signal in signal list, and you accessed this function from the front panel, the following message will prompt you for confirmation to delete all signals from the signal list. Importing a Signal List always replaces the data with the data that is already in the signal list.

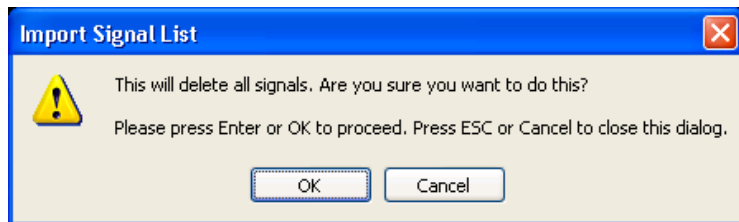

When recalling a signal list, the current value of the Y-axis unit will be used to display the data. The limit to delta values will be imported, you have to perform Update  $\Delta$  limit in order to see the updated limit delta based on current limit setting.

Key Path	Recall, Data
Remote Command	:MMEMory:LOAD:SLISt <filename>
Example	MMEM:LOAD:SLIS "mySignalList2.csv" Imports the Signal List from the file mySignalList2.csv in the default path.
Notes	If the file is empty, error -250.3005 is reported. If the file does not exist error -256 is reported. If there is a mismatch between the file and the destination data type, an error is reported. -250.3003. Then return to the Import Data menu and File Open dialog goes away. Before loading a signal list file, any running scan sequence will be stopped unless it is in Scan Only.
Status Bits/OPC Dependencies	Sequential - aborts the current measurement
Initial S/W Revision	A.07.00

## Scan Table

Selects the scan table as the data type to be imported.

Key Path	Recall, Data
Remote Command	:MMEMory:LOAD:SCAN <filename>
Example	MMEM:LOAD:SCAN "myScanTable1.csv" Imports the Scan Table from the file myScanTable1.csv in the default path.
Notes	If the file is empty, error -250.3005 is reported. If the file does not exist error -256 is reported. If there is a mismatch between the file and the destination data type, an error is reported. -250.3003. Then return to the Import Data menu and File Open dialog goes away. Before loading a signal list file, any running scan sequence will be stopped.
Couplings	No
Status Bits/OPC Dependencies	Sequential - aborts the current measurement
Initial S/W Revision	A.07.00

## Open...

When you press "Open", the analyzer brings up a Windows dialog and a menu entitled "**File Open.**" This menu allows you to navigate to the various fields in the Windows dialog without using a keyboard or mouse. The Tab and Arrow keys can also be used for dialog navigation.

See "[From File...](#)" on page 1083 in Recall, State, for a full description of this dialog and menu.

Key Path	Recall, Data
Notes	The key location is mode-dependent and will vary. Brings up Open dialog for recalling a <mode specific> Save Type
Initial S/W Revision	Prior to A.02.00

## State

Most of the functions under this key work the same way in many measurements, so they are documented in the Utility Functions section. For details about this key, see "[State](#)" on page 1081.

## Data (Import)

Most of the functions under this key work the same way in many measurements, so they are documented in the Utility Functions section. For details about this key, see "[Data \(Import\)](#)" on page 1086.

## Amplitude Correction

Most of the functions under this key work the same way in many measurements. For details about this key, see "[Amplitude Correction](#)" on page 1087.

### Default Directory

Specifies the default directory used for loading of Amplitude Correction. If user is selected, the default recall directory is the default (My Documents\amplitudeCorrections) or the last directory you saved the amplitude correction data to. Otherwise, the default recall directory is My Documents\EMC Limits and Ampcor\Ampcor, which contains a set of preloaded amplitude correction files in the directory called Ampcor.

Key Path	Recall, Export Data, Amplitude Correction
Remote Command	:MMEMory:LOAD:CORRection:DDIRectory USER PRELoaded
Example	:MMEM:LOAD:CORR:DDIR USER Select user :MMEM:LOAD:CORR:DDIR?
Notes	USER = User PRELoaded = Preloaded
Preset	PRELoaded
State Saved	Saved in instrument state.
Range	User  Preloaded
Readback	"User" "Preloaded"
Initial S/W Revision	A.13.00

### Trace

This key selects Trace as the data type to be imported. When pressed a second time, it brings up the Trace Menu, which lets you select the Trace into which the data will be imported.

The trace file contains "meta" data which describes the state of the analyzer when the trace was exported (see ). If the meta data in the file does not match the current SA state, the "invalid data indicator" (\*) is displayed.

Key Path	Recall, Data
Remote Command	:MMEMory:LOAD:TRACe:DATA TRACE1 TRACE2 TRACE3,<filename>
Example	:MMEM:LOAD:TRAC DATA TRACE2, "myTrace2.csv" imports the 2nd trace from the file myTrace2.csv in the current path. The default path is My Documents\EMI\data\xxx\traces where xxx is the measurement name.
Dependencies	A trace cannot be recalled from a trace file that was exported with ALL traces selected. A trace cannot be imported if the number of trace points in the file do not match the number of sweep points currently set for the measurement. If this happens, an error message is generated. Errors are reported if the file is empty or missing, or if the file type does not match, or if there is a mismatch between the file type and the destination data type. If any error occurs while trying to load a file manually (as opposed to during remote operation), the analyzer returns to the Import Data menu and the File Open dialog goes away.
Couplings	When a trace is imported, <b>Trace Update</b> is always turned OFF for that trace and <b>Trace Display</b> is always turned ON.

Readback	1 2 3
Status Bits/OPC dependencies	Sequential - aborts the current measurement.
Initial S/W Revision	Prior to A.02.00

## Limit

This key selects Limit Lines as the data type to be imported. When pressed a second time, it brings up the Limits Menu, which lets you select into which Limit the data will be imported.

Key Path	Recall, Data
<b>Remote Command</b>	:MMEMory:LOAD:LIMit LLINE1   LLINE2   LLINE3   LLINE4   LLINE5   LLINE6, <filename>
<b>Example</b>	:MMEM:LOAD:LIM LLINE2, "myLimitLine2.csv" imports the 2nd Limit Line from the file myLimitLine2.csv in the current path. The default path is depending on the Limit Default Directory selection.
Dependencies	Errors are reported if the file is empty or missing, or if the file type does not match, or if there is a mismatch between the file type and the destination data type. If any of these occur during manual operation, the analyzer returns to the Import Data menu and the File Open dialog goes away. This key will only appear if you have the proper option installed in your instrument.
Couplings	When a limit line is loaded from mass storage, it is automatically turned on. This allows you to see it, thus confirming the load. The Margin settings will match those set when the limit was saved
Readback	1 2 3 4 5 6
Status Bits/OPC dependencies	Sequential - aborts the current measurement
Initial S/W Revision	A.02.00

## Default Directory

Specifies the default directory used for loading of Limit. If user is selected, the default recall directory is the default (My Documents\EMI\data\xxx\Limits where xxx is the measurement name) or the last directory you saved the limit line data to. Otherwise, the default recall directory is My Documents\EMC Limits and Ampcor\Limits, which contains a set of preloaded limit files.

Key Path	Recall, Export Data, Limit
<b>Remote Command</b>	:MMEMory:LOAD:LIMit:DDIRectory USER PRELoaded
<b>Example</b>	:MMEM:LOAD:LIM:DDIR USER Select user :MMEM:LOAD:LIM:DDIR?
Notes	USER = User PRELoaded = Preloaded
Preset	PRELoaded

State Saved	Saved in instrument state.
Range	User  Preloaded
Readback	"User"  "Preloaded"
Initial S/W Revision	A.13.00

## Open

Most of the functions under this key work the same way in many measurements. For details about this key, see ["Open..." on page 1089](#).



## Restart

The Restart function restarts the current sweep, or measurement, or set of averaged/held sweeps or measurements. If you are Paused, pressing Restart does a Resume.

The Restart function is accessed in several ways:

- Pressing the Restart key
- Sending the remote command INIT:IMMEDIATE
- Sending the remote command INIT:RESTART

See "[More Information](#)" on page 537

Key Path	Front-panel key
Remote Command	:INITiate[:IMMEDIATE] :INITiate:RESTART
Example	:INIT:IMM :INIT:REST
Notes	:INITiate:RESTART and :INITiate:IMMEDIATE perform exactly the same function.
Couplings	Resets average/hold count k. For the first sweep overwrites all active (update=on) traces with new current data. For application modes, it resets other parameters as required by the measurement.
Status Bits/OPC dependencies	This is an Overlapped command. The STATUS:OPERation register bits 0 through 8 are cleared. The STATUS:QUESTIONable register bit 9 (INTEgrity sum) is cleared. The SWEEPING bit is set. The MEASURING bit is set.
Backwards Compatibility Notes	For Spectrum Analysis mode in ESA and PSA, the Restart hardkey and the INITiate:RESTART command restart trace averages (displayed average count reset to 1) for a trace in Clear Write, but did not restart Max Hold and Min Hold. In the X-Series, the Restart hardkey and the INITiate:RESTART command restart not only Trace Average, but MaxHold and MinHold traces as well. For wireless comms modes in ESA and PSA, the Restart hardkey and the INITiate:RESTART command restart every measurement, which includes all traces and numeric results. There is no change to this operation.
Initial S/W Revision	Prior to A.02.00

### More Information

The **Restart** function first aborts the current sweep/measurement as quickly as possible. It then resets the sweep and trigger systems, sets up the measurement and initiates a new data measurement sequence with a new data acquisition (sweep) taken once the trigger condition is met.

If the analyzer is in the process of aligning when **Restart** is executed, the alignment finishes before the restart function is performed.

Even when set for Single operation, multiple sweeps may be taken when Restart is pressed (for example, when averaging/holding is on). Thus when we say that **Restart** "restarts a measurement," we may mean:

- It restarts the current sweep
- It restarts the current measurement
- It restarts the current set of sweeps if any trace is in Trace Average, Max Hold or Min Hold
- It restarts the current set of measurements if Averaging, or Max Hold, or Min Hold is on for the measurement
- depending on the current settings.

With **Average/Hold Number** (in **Meas Setup** menu) set to 1, or Averaging off, or no trace in Trace Average or Hold, a single sweep is equivalent to a single measurement. A single sweep is taken after the trigger condition is met; and the analyzer stops sweeping once that sweep has completed. However, with **Average/Hold Number** >1 and at least one trace set to **Trace Average, Max Hold, or Min Hold (SA Measurement)** or **Averaging on (most other measurements)**, multiple sweeps/data acquisitions are taken for a single measurement. The trigger condition must be met prior to each sweep. The sweep is stopped when the average count  $k$  equals the number  $N$  set for **Average/Hold Number**. A measurement average usually applies to all traces, marker results, and numeric results; but sometimes it only applies to the numeric results.

Once the full set of sweeps has been taken, the analyzer will go to idle state. To take one more sweep without resetting the average count, increment the average count by 1, by pressing the step up key while **Average/Hold Number** is the active function, or sending the remote command **CALC:AVER:TCON UP**.

## Save

The Save menu lets you choose what you want to save and where you want to save it. Among the types of files you can save are **States**, **Traces**, and **Screen Images**. In addition, an Export (Data) option lets you save a number of data types as CSV files for easy import into Excel and other spreadsheet programs.

Key Path	Front-panel key
Mode	All
Notes	No remote command for this key specifically, but the :MMEM:STORe command is available for specific file types. An example is :MMEM:STOR:STATe <filename>.
Initial S/W Revision	Prior to A.02.00

## State

The Save State menu lets you choose a register or file for saving the state.

The content of a state file includes all of the settings and data required to return the analyzer as closely as possible to the Mode it was in, with the exact settings which were in place, when the save occurred. The Mode settings in each state file include the settings that are affected by Mode Preset, as well as the additional settings affected by Restore Mode Defaults; all of the Mode's settings. In addition, all of the settings of the Input/Output system are included, even though they are outside of the Mode's state, because they are needed to restore the complete setup. Persistent System settings (for example, Verbose SCPI) are not affected by either Mode Preset or Restore Mode Defaults, nor are they included in a saved State file.

After the save completes, the message "File <filename> saved" or "State Register <register number> saved" is displayed.

For rapid saving, the State menu lists 16 registers to save to. Pressing a Register key initiates the save. You can also select a file to save to.

The default path for all State Files is:

My Documents\<>mode name>\state

where <mode name> is the parameter used to select the mode with the INST:SEL command (for example, SA for the Spectrum Analyzer).

Key Path	Save
Mode	All
Remote Command	:MMEMory:STORe:STATe <filename>
Example	MMEM:STOR:STATe "MyStateFile.state" This stores the current instrument state data in the file MyStateFile.state in the default directory.
Notes	Both single and double quotes are supported for any filename parameter over remote. After saving to a register, that register's menu key is updated with the date the time, unless a custom label has been entered for that key. After saving to a register, you remain in the Save State menu, so that you can see the Register key

	update. After saving to a file, the analyzer automatically returns to the previous menu and any Save As dialog goes away.
<b>Backwards Compatibility SCPI</b>	:MMEMory:STORe:STATe 1,<filename> For backwards compatibility, the above syntax is supported. The "1" is simply ignored. The command is sequential.
Initial S/W Revision	Prior to A.02.00

### To File . . .

When you press “To File”, the analyzer brings up a Windows dialog and a menu entitled “Save As.” This menu allows you to navigate to the various fields in the Windows dialog without using a keyboard or mouse. The Tab and Arrow keys can also be used for dialog navigation.

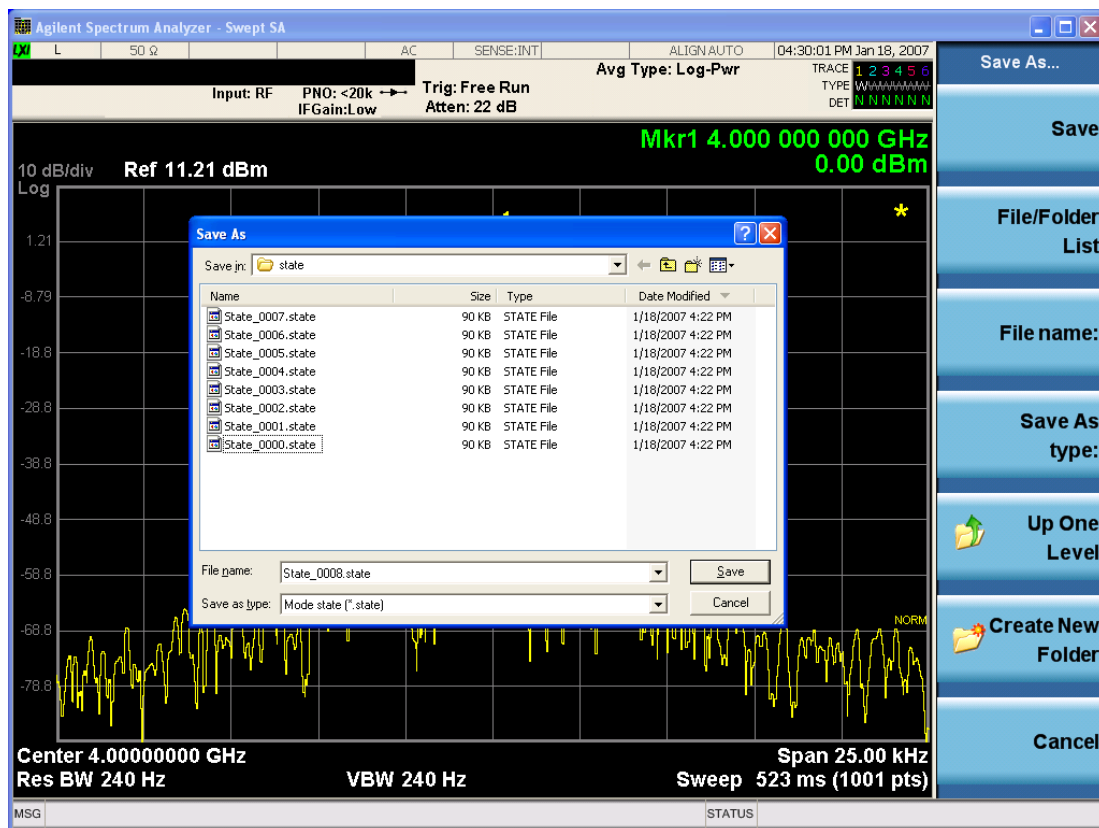

The Listed below

are the functions of the various fields in the dialog, and the corresponding softkeys:

#### Save

Performs the save to the specified file of the selected type. If the file already exists, a dialog will appear that allows you to replace the existing file by selecting OK, or you can Cancel the request. If you select OK, the file will be overwritten. Using the C: drive is strongly discouraged, since it runs the risk of being overwritten during an instrument software upgrade.

While the save is being performed, the floppy icon appears briefly in the Meas bar.

### File/Folder List

Enables you to navigate to the center of the dialog that contains the list of files and folders. Once here you can get information about the file and use the tab keys to navigate to the other fields in the dialog, such as Save In.

### Save In

The Save In field shows the path to which the file will be saved and allows you to change the path using the up and down arrow keys to navigate to other paths; the Enter key to open a directory; and the Backspace key to go back one directory. The **Save In field** defaults to the default path for this type of file and remembers the last path you used to save this type of file. There is no softkey for directly navigating to the Save In field but you can use left tab to get here from the File/Folder List.

User specified paths are remembered when you leave and return to a Mode and are reset back to the default using Restore Mode Defaults.

### File Name

The File Name field is initially loaded with an automatically generated filename specific to the appropriate Save Type. The automatically generated filename is guaranteed not to conflict with any filename currently in the directory. You may replace or modify this filename using the File Name key. See the ["Quick Save " on page 1079](#) documentation for more on the automatic file naming algorithm.

When you press the File Name key the analyzer displays the Alpha Editor. Use the knob to choose the letter to add and the front-panel Enter key to add the letter to the file name. The BK character moves you back and the FW character moves you forward in the filename. The Select key on the front panel generates a space character. When you are done entering the filename press the Done softkey. This returns back to the **File Open** dialog and menu, but does not cause the save to occur.

### Save As Type

This field shows the file suffix for the type of file you have selected to save. For example, if you navigated here while saving State, "Mode state (\*.state)" is in the field. If you navigated here from saving Trace, ""Mode state (\*.trace)" is in the field. If you navigated here while exporting a trace data file, "Trace Data (\*.csv)" is in the field. For some file types, there is more than one choice in the dropdown, which you can select by using the up and down arrow keys and Enter.

### Up One Level

This key corresponds to the icon of a folder with the up arrow that is in the tool bar of the dialog. When pressed, it causes the file and folder list to navigate up one level in the directory structure. The Backspace key does the same thing.

### Create New Folder

This key corresponds to the icon of a folder with the "\*" that is in the tool bar of the dialog. When pressed, a new folder is created in the current directory with the name **New Folder** and you can enter a new folder name using the Alpha Editor.

### Cancel

This key corresponds to the Cancel selection in the dialog. It causes the current **Save As** request to be cancelled. The ESC key does the same thing.

Key Path	Save, State
Mode	All
Notes	Brings up Save As dialog for saving a State Save Type
Initial S/W Revision	Prior to A.02.00

## Edit Register Names

You may enter a custom name on any of the Register keys, to help you remember what you are using that state to save. To do this, press the Edit Register Names key, choose the register whose name you wish to edit, and then enter the desired label using the Alpha Editor or an external PC keyboard.

The maximum number of characters that can be added is 30. In most cases, 30 characters will fit on two lines of the key.

See ["More Information" on page 542](#)

Key Path	Save, State
Mode	All
<b>Remote Command</b>	:MMEMory:REGister:STATe:LABel <reg number>,"label" :MMEMory:REGister:STATe:LABel? <reg number>
<b>Example</b>	:MMEM:REG:STAT:LAB 1,"my label"
Notes	<reg number> is an integer from 1 to 16. If the SCPI specifies an invalid register number an error message is generated, -222,"Data out of range;Invalid register label number" "label" is a string from 0 to 30 characters in length. If a label exceeds 30 characters, an error message is generated, -150,"String data error;Label clipped to 30 characters" "label" of length 0 erases the custom label and restores the default (time and date) label. E.g.: :MMEM:REG:STAT:LAB 1,""
Dependencies	N9060A-7FP or N9060B-2FP license required to edit the register names. When the feature is not licensed, sending this command generates an error, -221,"Settings conflict;Option not available"
Preset	The names are unaffected by Preset or power cycle but are set to the default label (time and date) on a "Restore System Defaults->Misc"
Initial S/W Revision	A.11.00

## More Information

When you edit one of the register names, the time and date field will be replaced by the custom name.

If you delete all the characters in the custom name, it restores the default (time and date).

The register names are stored within the state files, but they are not part of the instrument state; that is, once you have edited a register name, loading a new state will not change that register name. Another consequence of this is that the names will be persistent through a power cycle. Also, if a named state file is transferred to another analyzer, it will bring its custom name along with it.

If you try to edit the name of an empty register, the analyzer will first save the state to have a file to put the name in. If you load a named state file into an analyzer with older firmware it will ignore the metadata.

The \*SAV and \*RCL commands will not be affected by the custom register names, nor will the MMEM commands.

### Register 1 thru Register 16

Selecting any one of these register menu keys causes the State of the currently active mode to be saved to the specified Register. The registers are provided for rapid saving and recalling, since you do not need to specify a filename or navigate to a file. Each of the register menu keys annotates whether it is empty or at what date and time it was last modified. In addition, you can use the Edit Register Names key to enter custom names for each register.

Although these 16 registers are the only registers available from the front panel, there are 128 state registers available in the instrument. Registers 17–128 are only available from the SCPI interface, using the \*SAV command.

There is one set of 128 state registers in the instrument, not one set for each Mode. When a state is saved, the Mode it was saved from is saved with it; then when it is recalled, the instrument switches to that Mode.

After the save completes, the corresponding register menu key annotation is updated with the date and time and the message "Register <register number> saved" is displayed.

Key Path	Save, State
Mode	All
<b>Example</b>	*SAV 1
Range	1–16 from front panel, 1–128 from SCPI
Readback	Date and time with seconds resolution are displayed on the key OR A custom name of up to 30 characters entered using the Edit Register Names key OR “(empty)” if no prior save operation has been performed to this register.
Initial S/W Revision	Prior to A.02.00
Modified at S/W Revision	A.11.00

### Register 1 thru Register 16

Selecting any one of these register menu keys causes the State of the currently active mode to be saved to the specified Register. The registers are provided for rapid saving and recalling, since you do not need to specify a filename or navigate to a file. Each of the register menu keys annotates whether it is empty or at what date and time it was last modified. In addition, you can use the Edit Register Names key to enter custom names for each register.

Although these 16 registers are the only registers available from the front panel, there are 128 state registers available in the instrument. Registers 17–128 are only available from the SCPI interface, using the \*SAV command.

There is one set of 128 state registers in the instrument, not one set for each Mode. When a state is saved, the Mode it was saved from is saved with it; then when it is recalled, the instrument switches to that Mode.

After the save completes, the corresponding register menu key annotation is updated with the date and time and the message "Register <register number> saved" is displayed.

Key Path	Save, State
Mode	All
Example	*SAV 1
Range	1-16 from front panel, 1-128 from SCPI
Readback	Date and time with seconds resolution are displayed on the key OR A custom name of up to 30 characters entered using the Edit Register Names key OR “(empty)” if no prior save operation has been performed to this register.
Initial S/W Revision	Prior to A.02.00
Modified at S/W Revision	A.11.00

### Save As . . .

When you press “Save As”, the analyzer brings up a Windows dialog and a menu entitled “**Save As.**” This menu allows you to navigate to the various fields in the Windows dialog without using a keyboard or mouse. The Tab and Arrow keys can also be used for dialog navigation.

See "[To File . . .](#)" on page 1096 in Save, State for a full description of this dialog and menu.

The default path for saving files is:

For all of the Trace Data Files:

My Documents\<<mode name>\data\traces

For all of the Limit Data Files:

My Documents\<<mode name>\data\limits

For all of the Measurement Results Data Files:

My Documents\<<mode name>\data\<<measurement name>\results

For all of the Capture Buffer Data Files:

My Documents\<<mode name>\data\captureBuffer

Key Path	Save, Data
Mode	All
Notes	The key location is mode-dependent and will vary. Brings up the Save As dialog for saving a <mode specific> Save Type. The save is performed immediately and does not wait until the measurement is complete.
Initial S/W Revision	Prior to A.02.00



## Data (Export)

Exporting a data file stores data from the current measurement to mass storage files. The Export Menu only contains data types that are supported by the current measurement.

Since the commonly exported data files are in .csv format, the data can be edited by you prior to importing. This allows you to export a data file, manipulate the data in Excel (the most common PC Application for manipulating .csv files) and then import it.

Selecting an Export Data menu key will not actually cause the exporting to occur, since the analyzer still needs to know where you wish to save the data. Pressing the Save As key in this menu brings up the Save As dialog and Save As menu that allows you to specify the destination file and directory. Once a filename has been selected or entered in the Open menu, the export will occur as soon as the Save key is pressed.

Key Path	Save
Mode	All
Notes	The menu is built from whatever data types are available for the mode. So the key locations in the sub menu will vary.  No SCPI command directly controls the Data Type that this key controls. The Data Type is included in the MMEM:STORe commands.
Dependencies	If a file type is not used by a certain measurement, that type is grayed out for that measurement. The key for a file type will not show at all if there are no measurements in the Mode that support it.
Preset	Is not affected by a Preset or shutdown, but is reset during Restore Mode Defaults
Readback	The data type that is currently selected
Initial S/W Revision	Prior to A.02.00

## Amplitude Correction

Pressing this key selects **Amplitude Corrections** as the data type to be exported. Pressing this key again brings up the Select Menu, which allows the user to select which **Amplitude Correction** to save.

Amplitude Corrections are fully discussed in the documentation of the Input/Output key, under the Corrections softkey.

See "[Correction Data File](#)" on page 546

Key Path	Save
Remote Command	:MMEMory:STORe:CORRection 1 2 3 4 5 6, <filename>
Example	:MMEM:STOR:CORR 2 "myAmpcor.csv" saves Correction 2 to the file myAmpcor.csv on the current path.  The default path is My Documents\amplitudeCorrections.
Notes	If the save is initiated via SCPI, and the file already exists, the file will be overwritten.  Using the C: drive is strongly discouraged, since it runs the risk of being overwritten during an instrument software upgrade.  Both single and double quotes are supported for any filename parameter over SCPI.

Dependencies	Corrections are not supported by all Measurements. If in a Mode in which some Measurements support it, this key will be grayed out in measurements that do not. The key will not show at all if no measurements in the Mode support it.  This key will not appear unless you have the proper option installed in your instrument.
Readback	Selected Correction
<b>Backwards Compatibility SCPI</b>	:MMEMory:STORe:CORRection ANTenna   CABLe   OTHer   USER, <filename>  For backwards compatibility, ANTenna maps to 1, CABLe maps to 2, OTHer maps to 3 and USER maps to 4
Initial S/W Revision	A.02.00

### Correction Data File

A Corrections Data File contains a copy of one of the analyzer correction tables. Corrections provide a way to adjust the trace display for predetermined gain curves (such as for cable loss).

Corrections files are text files in .csv (comma separated values) form, to make them importable into Excel or other spreadsheet programs. The format for Corrections files is as follows.

Line #	Type of field	Example	Notes
1	File type, must be "Amplitude Correction"	Amplitude Correction	May not be omitted
2	File Description (in quotes)	"Correction Factors for 11966E"	60 characters max; may be empty but may not be omitted. If exceeds 60 characters, error -233 Too much data reported
3	Comment (in quotes)	"Class B Radiated"	60 characters max; may be empty but may not be omitted. . If exceeds 60 characters, error -233 Too much data reported
4	Instrument Version, Model #	A.02.06,N9020A	May be empty but may not be omitted
5	Option List, File Format Version	K03 LFE EXM ,01	May be empty but may not be omitted
6	Freq Unit to be used for all frequency values in the file	Frequency Unit,MHz	assumed to be Hz if omitted
7	Antenna Unit	Antenna Unit,None	If omitted leaves the Antenna unit unchanged. The amplitude unit in the Antenna Unit field is a conversion factor that is used to adjust the Y Axis Units of the current mode, if the mode supports Antenna Units. For more details on antenna correction data, refer to the Input/Output,Corrections key description. Allowable values: dBuV/m, dBuA/m, dBG, dBpT, None

Line #	Type of field	Example	Notes
8	Freq Interpolation	Frequency Interpolation,Linear	if omitted leaves the Freq Interpolation unchanged. Allowable values: Linear, Logarithmic
9	Bias value in mA	Bias,0.00	If omitted leaves the Bias value unchanged (added as of A.08.50)
10	Bias State	Bias State,On	If omitted leaves the Bias State unchanged. Allowable values: On, Off (added as of A.08.50)
11	Overlap, two values, Freq1 and Freq2, separated by commas.	Overlap,33500,40000	Uses Freq Unit from line 6. Thus, in this example Freq1=33.5 GHz, Freq2= 40.0 GHz (see note below). If omitted leaves the overlap unchanged (added as of A.08.50)
12	DATA marker	DATA	Corrections data begins in the next line

Lines 2 through 5 can be empty but must appear in the file. Lines 6 through 11 are optional, the lines can be left out of the file altogether.

The Overlap row and the two Bias rows apply only to external mixing. Both are read-only, they are never written by the analyzer. The only way to insert or modify these rows is to edit the file with a text editor or a spreadsheet editor. These rows are intended for use by mixer manufacturers, as they allow the manufacturer to insert data about how the mixer corrections were generated and how they should be applied. The Bias rows allow you to specify whether to turn Bias on or off when the Correction is turned on and to specify a Bias value (turning off the Correction does not change the Bias, but turning it back on again sets it to the value specified in the file). The Overlap row allows you to specify an overlap region in which two different corrections may be applied. It is expected that in the corrections data itself, there will be TWO corrections values exactly at Max Freq, otherwise Overlap is ignored. The way the overlap is processed is as follows: if at any given time the current analyzer Start Freq is greater than Freq 1 and lower than Freq 2, and the current Stop Freq is greater than Freq 2, extend the first correction point at or above Freq 2 down to Freq 1, rather than using the correction data between Freq1 and Freq2.

The Antenna Unit row can only be used in Correction register 1, because there can only be one setting for Antenna Unit at any given time. If a Correction whose Antenna Unit is set to anything but None is loaded into any Correction register but 1, an error is generated (Mass storage error; Can only load an Antenna Unit into Correction 1). When a correction file is saved from any Correction register but 1, Antenna Unit is always written as None.

Similarly, the Bias rows can only be used in Correction register 1, because there can only be one setting for Bias at any given time. If a Correction file with a Bias or Bias State row is loaded into any Correction register but 1, an error is generated: Mass storage error; Can only load Bias Settings into Correction 1

The data follows the DATA row, as comma separated X, Y pairs; one pair per line.

For example, suppose you have an Antenna to correct for on an N9020A version A.02.06 and the correction data is:

- 0 dB at 200 MHz

- 17 dB at 210 MHz
- 14.8 dB at 225 MHz

Then the file will look like:

- Amplitude Correction
- "Correction Factors for 11966E"
- "Class B Radiated"
- A.02.06,N9020A
- P13 EA3 UK6,01
- Frequency Unit,MHz
- Antenna Unit,dBuV/m
- Frequency Interpolation,Linear
- DATA
- 200.000000,0.00
- 210.000000,17.00
- 225.000000,14.80

The choices for the 1 of N fields in the metadata are as follows:

- Frequency Unit: Hz, kHz, MHz, GHz
- Antenna Unit: dBuV/m, dBuA/m, DBG, dBpT, None
- Frequency Interpolation: Logarithmic, Linear

## Trace

Pressing this key selects Traces as the data type to be exported. Pressing this key when it is already selected brings up the Trace Menu, which allows you to select which Trace to save.

The trace file contains “meta” data which describes the current setting of the analyzer, but it is not eh full state of the analyzer. The trace file content is detailed in:

["Frequency Scan Trace File Content" on page 549](#)

["Strip Chart Trace File Content" on page 550](#)

["Monitor Spectrum Trace File Content" on page 551](#)

Key Path	Save, Data
<b>Remote Command</b>	:MMEMory:STORe:TRACe:DATA TRACE1   TRACE2   TRACE3   ALL,<filename>
<b>Example</b>	:MMEM:STOR:TRAC:DATA TRACE2, "myTrace2.csv" exports the 2nd trace to the file myTrace2.csv in the current path. The default path is My Documents\EMI\data\xxx\Traces where xxx is the measurement name.
<b>Notes</b>	If the save is initiated via SCPI, and the file already exists, the file will be overwritten.

	Using the C: drive is strongly discouraged, since it runs the risk of being overwritten during an instrument software upgrade. Both single and double quotes are supported for any filename parameter over SCPI.
Dependencies	Traces cannot be recalled from a trace file that was saved with ALL traces selected.
Readback	1 2 3 All
Status Bits/OPC dependencies	Sequential - waits for previous measurement to complete
Initial S/W Revision	Prior to A.02.00

### Frequency Scan Trace File Content

The following file example shows the Trace file content in Excel for one trace.

Trace	
EMI:FSCAN	
A.07.00	N9020A
526 EA3 B25 P26 PFR	1
Preselector	
	On
Scan Type	
	Smooth
Number of scans	
	1
Y Axis Unit	
	dBuV
Ref Level Offset	
	0 dB
Coupling	
	AC
Input Z Correction	
	50 ohm
Data	
Trace	1
Detector	
	Peak
30000000	-91.67179747
30060002.47	-91.73843172
30120004.95	-88.07746798
30180007.42	-90.05428387
30240009.9	-86.55925246
30300012.37	-87.6724363
30360014.85	-93.18478677
30420017.32	-95.06361113
30480019.79	-91.02766645

30540022.27	-90.66836416
30600024.74	-87.10931161

### Strip Chart Trace File Content

The following file example shows the Trace file content in Excel.

AllTrace			
EMI:Schart			
A.07.00_R0009	N9020A		
526 EA3 B25 P26 PFR	1		
Frequency	600000000		
Freq Offset	0		
Attenuation	10		
Y Axis Unit	dBuV		
Ref Level Offset	0		
Internal Preamp State	Off		
Internal Preamp Band	Low		
Resolution Bandwidth	120000		
Dwell Time	0.05		
Peak Hold	Infinite		
Peak Hold Time	2		
Max Duration	500		
Data			
Trace	1	2	3
Detector	Peak	QuasiPeak	EmiAverage
Max	25.4396633	20.242876	12.356569
0	23.7515958	20.173686	12.282337
-0.05	24.6648769	20.194918	12.262222
-0.1	23.3178199	20.213507	12.253423
-0.15	23.5216423	20.221337	12.258119
-0.2	23.4602343	20.220859	12.262763
-0.25	23.5765176	20.212508	12.297994
-0.3	23.7032533	20.197088	12.325791
-0.35	24.825583	20.185434	12.332104

-0.4	23.6549108	20.186032	12.352822
-0.45	23.1558073	20.184001	12.356569
-0.5	23.8378283	20.171481	12.352344
-0.55	24.0481835	20.148553	12.329247
-0.6	23.7659679	20.165786	12.308906
-0.65	23.6379256	20.191835	12.330754
-0.7	23.1793252	20.20728	12.316628
-0.75	23.7241582	20.208026	12.324215
-0.8	24.0573294	20.205218	12.343919

### Monitor Spectrum Trace File Content

The following file example shows the Trace file content in Excel.

Trace	
EMI:MON	
A.13.00	N9038A
526 DP2 EMC LSN	1
Preselector	
	On
Y Axis Unit	
	dBuV
Ref Level Offset	
	0 dB
Coupling	
	AC
Input Z Correction	
	50 ohm
DATA	
Trace	1
Detector	
	Peak
29740009.9	9.302139008
29741009.9	9.609657014
29742009.9	9.945373261
29743009.9	10.28534671
29744009.9	10.59982272
29745009.9	10.84645816
29746009.9	10.97216769
29747009.9	10.93370792
29748009.9	10.70057651

29749009.9	10.21771213
29750009.9	9.474250519
29751009.9	8.374183381
29752009.9	6.909049714
29753009.9	4.86714145
29754009.9	2.253837311
29755009.9	-0.937874114
29756009.9	-4.154472625

## Limit

Pressing this key selects Limit Lines as the data type to be exported. Pressing the key a second time brings up the Limit Menu that allows you to select which **Limit Line** to save.

See "[Limits File Contents](#)" on page 552.

See "[.csv file format](#)" on page 553

See "[.lim file format](#)" on page 554

Key Path	Save, Data
<b>Remote Command</b>	:MMEMory:StORe:LIMit LLINE1   LLINE2   LLINE3   LLINE4   LLINE5   LLINE6,<filename>
<b>Example</b>	:MMEM:StOR:LIM LLINE2, "myLimitLine2.csv" saves the 2nd Limit Line to the file myLimitLine2.csv in the current path. The default path is My Documents\EMI\data\xxx\limits where xxx is the measurement name.
<b>Notes</b>	If the save is initiated via SCPI, and the file already exists, the file will be overwritten. Using the C: drive is strongly discouraged, since it runs the risk of being overwritten during an instrument software upgrade. Both single and double quotes are supported for any filename parameter over SCPI.
<b>Dependencies</b>	This key will only appear if you have the proper option installed in your instrument.
<b>Preset</b>	1; not part of Preset, but is reset by Restore Mode Defaults and survives power cycles
<b>State Saved</b>	The selected Limit number is saved in instrument state.
<b>Readback</b>	1 2 3 4 5 6
<b>Status Bits/OPC dependencies</b>	Sequential - waits for previous measurement to complete
<b>Initial S/W Revision</b>	A.02.00

## Limits File Contents

Limits may be exported into a data file with a .csv extension. They may be imported from that data file; they may also be imported from a legacy limit file with a .lim extension. The .lim files meet the specification for



limit files contained in the EMI measurement guide, HP E7415A.

### .csv file format

Except for information in quotes, limit line files are not case sensitive. Information in bold is required verbatim; other text is example text, and italic text is commentary which should not be present in the file.

The first five lines are system-required header lines, and must be in the correct order.

<b>Limit</b>	<i>Data file type name</i>
<b>"FCC Part 15"</b>	<i>File Description</i>
<b>"Class B Radiated"</b>	<i>Comment</i>
<b>A.01.00.R0001.N9020A</b>	<i>Instrument Version, Model Number</i>
<b>P13 EA3 UK6 .01</b>	<i>Option List, File Format Version</i>

The next few lines describe the parameters; on export they will be in the order shown, on import they can be in any order. If some parameters are missing, they will revert to the default.

<b>Type, Upper</b>	<i>Upper Lower</i>
<b>X Axis Unit, MHz</b>	<i>MHz S; other units should be converted; this also specifies the domain</i>
<b>Amplitude Unit, dBm</b>	<i>dBm V; all other units should be converted appropriately</i>
<b>Frequency Interpolation, Linear</b>	<i>Logarithmic Linear</i>
<b>Amplitude Interpolation, Logarithmic</b>	<i>Logarithmic Linear</i>
<b>X Control, Fixed</b>	<i>Fixed Relative; on input we consider only the first three characters</i>
<b>Y Control, Fixed</b>	<i>Fixed Relative; on input we consider only the first three characters</i>
<b>Margin, 0</b>	<i>Always in dB. A 0 margin is equivalent to margin off</i>
<b>X Offset, 10</b>	<i>Expressed in the X axis units</i>
<b>Y Offset, 5</b>	<i>Expressed in the Amplitude units</i>

The Amplitude Unit line in the limits file may contain an antenna factor unit, for example:

Amplitude Unit=dBuV/m

Antenna factor units are dBuV/m, dBuA/m, dBpT, and dBG. In this case, the unit is treated exactly as though it were dBuV, meaning that all of the limits are interpreted to have units of dBuV. The box does NOT change Y Axis Units when such a limit is loaded in.

The X axis unit also specifies the domain (time or frequency). It is not possible to have both time-domain lines and frequency-domain lines at the same time; if a time-domain line is imported while the other lines are in the frequency domain (or vice-versa), all limit lines will be deleted prior to import.

If the sign of the margin is inappropriate for the limit type (for example a positive margin for an upper limit), the sign of the margin will be changed internally so that it is appropriate.

The remaining lines describe the data. Each line in the file represents an X-Y pair. The X values should be monotonically non-decreasing, although adjacent lines in the file can have the same X value as an aid to building a stair-stepped limit line. To specify a region over which there is no limit, use +1000 dBm for upper limits or -1000 dBm for lower limits.

The data region begins with the keyword DATA:

<b>DATA</b>
200.000000,-10.00
300.000000,-10.00
300.000000,-20.00
500.000000,-20.00

### .lim file format

This is a legacy format which allows files saved from older analyzers to be loaded into the X-Series. Design of files in this format is not recommended.

### Signal List

Pressing this key selects Signal List as the data type to be exported with a save request. The next step is to select the Save As key in the Save Data menu.

See "[Signal List File](#)" on page 554 for an example of data contained in the list.

Key Path	Save, Data
Remote Command	:MMEMory:STORe:SLISt <filename>
Example	MMEM:STOR:SLIS "C:\My Documents\EMI\data\mySignalList2.csv" exports the Signal List to the file mySignalList2.csv in the default path.
Notes	The default path is at "My Documents\EMI\data\FSCAN\SignalList\SignalL_###.csv" If the save is initiated via SCPI, and the file already exists, the file will be overwritten. Using the C: drive is strongly discouraged, since it runs the risk of being overwritten during an instrument software upgrade. Both single and double quotes are supported for any filename parameter over SCPI.
Initial S/W Revision	A.07.00

### Signal List File

A Signal List file contains a copy of one of the signal lists obtained during measurement. The first four lines are system required header lines, and must be in the correct order.

SignalList	DataFileTypeName
EMI:FSCAN	Mode Name: Measurement Name
A.01.05N9020A	InstrumentVersion ModelNumber
K03 EMC SEC BBA P13 P08 BAB 5031	OptionList FileFormatVersion

The data follows as comma separated values. A keyword "DATA" precedes the data. Here is an example of signal list file with five signals on it:

SignalList
EMI:FSCAN
A.01.05,N9020A
B1X P13 EA3 BBA B2X ERC UK6 BAB EMC K03 B25 503 P08 526 508 513 S40 P26 B1C HBA P03 PFR ,01
Detector Limit,1,2,3
Final Detector,Peak,Sample,Average
Y Axis Unit,DecibelMicrovolt
DATA

---

```
SIG,MRK,TRC,FREQ,PEAK AMPL,QPD AMPL,EAVG AMPL,PEAK LL1 DELTA,QPD LL1 DELTA,EAVG LL1 DELTA,RBW,RBW
TYPE,TIMESTAMP,USE ANTENNA UNIT
1,False,0,200000000,21.8061675469286,16.2303531188485,8.41938906470973,-35.1935324964316,-
40.7693469245116,-48.5803109786505,120000,CISPR,2013/03/14 14:41:56,False
2,False,0,300000000,21.3482238148031,16.1882461755239,8.36820889147891,-35.651476228557,-
40.8114538678362,-48.6314911518813,120000,CISPR,2013/03/14 14:42:00,False
3,False,0,450000000,22.1630365302133,16.9299290135531,9.05807786531506,-34.8366635131469,-
40.0697710298071,-47.9416221780451,120000,CISPR,2013/03/14 14:42:04,False
4,False,1,771510577.7557838,23.3461676746558,17.551852007441,9.67230424390617,-33.6535323687044,-
39.4478480359192,-47.327395799454,120000,CISPR,2013/03/14 14:42:08,False
```

---

## Scan Table

Selects Signal List as the data type to be exported with a save request. The next step is to select the Save As key in the Save Data menu.

See "[Scan Table File](#)" on page 555 for an example of the data contained in a file.

Key Path	Save, Data
Remote Command	:MMEMory:STORe:SCAN <filename>
Example	MMEM:STOR:SCAN "C:\My Documents\EMI\data\ScanTable.csv" exports the Signal List to the file mySignalList2.csv in the default path.
Notes	The default path is at "My Documents\EMI\data\FSCAN\ScanTable\ScanT_xxxx.csv" If the save is initiated via SCPI, and the file already exists, the file will be overwritten. Using the C: drive is strongly discouraged, since it runs the risk of being overwritten during an instrument software upgrade. Both single and double quotes are supported for any filename parameter over SCPI. If the file is empty, "File <filename> not found" is reported. If there is a mismatch between the file and the destination data type, the error "Mismatch between File <filename> and the destination <data type and number>". Then return to the Import Data menu and File Open dialog goes away.
Initial S/W Revision	A.07.00

## Scan Table File

A Scan Table file contains a copy of one of the files obtained during a measurement. The first four lines are system required header lines, and must be in the correct order.

---

```
ScanTable                               DataFileName
EMI:FSCAN                               Mode Name: Measurement Name
A.01.05N9020A                           InstrumentVersion ModelNumber
K03 EMC SEC BBA P13 P08 BAB 5031 OptionList FileFormatVersion
```

---

- Attenuation

- Int Preamp Band
- Int Preamp State
- Log Percentage
- Meas Time
- Meas Time Mode
- Point/RBW
- RBW
- RBW Mode
- RF Input
- Scan Points
- Scan Points Mode
- Scan Time
- Scan Time Mode
- Start Freq
- State
- Step Auto Mode
- Step Size
- Step Size Mode
- Step Time Control
- Stop Freq

Here is an example of scan table file:

---

```
ScanTable
EMI:FSCAN
A.12.08,N9030A
526 ALV B25 B40 CR3 CRP DP2 EA3 EMC EP1 FSA LFE LNP MPB NFE NUL P26 PFR RTL YAV ,01
Step Time Control,Step Size & Dwell Time
State,OFF,OFF,OFF,OFF,ON,OFF,OFF,OFF,OFF,OFF
Start
Freq,9000,150000,30000000,300000000,300000000,1000000000,1000000000,1000100000,1000200000,1000300000
Stop
Freq,150000,30000000,300000000,1000000000,1000000000,1800000000,1000100000,1000200000,1000300000,1
000400000
RBW,200,9000,120000,120000,120000,1000000,1000000,1000000,1000000,1000000
RBW Mode,AUTO,AUTO,AUTO,AUTO,AUTO,AUTO,AUTO,AUTO,AUTO,AUTO
```

---

---

Dwell Time,0.0041021333333333,0.000108066666666717,6.73333333333333E-06,6.73333333336191E-06,6.73333333335395E-06,1.26666666667647E-06,0.001,0.001,0.001,0.001  
Dwell Time Mode,AUTO,AUTO,AUTO,AUTO,AUTO,AUTO,AUTO,AUTO,AUTO,AUTO,AUTO  
Step  
Size,100,4499.5477841423,60000,60003.4287673581,60002.4743288383,500000,100000,100000,100000,100000  
Step Size Mode,AUTO,AUTO,AUTO,AUTO,AUTO,AUTO,AUTO,AUTO,AUTO,AUTO,AUTO  
Scan Points,1411,6635,4501,11667,16167,34001,2,2,2,2  
Scan Points Mode,AUTO,AUTO,AUTO,AUTO,AUTO,AUTO,AUTO,AUTO,AUTO,AUTO,AUTO  
Scan  
Time,5.784008,0.716914266667,0.0303,0.078551066667,0.108851066667,0.043066666667,0.001,0.001,0.001,0.001  
Scan Time Mode,AUTO,AUTO,AUTO,AUTO,AUTO,AUTO,AUTO,AUTO,AUTO,AUTO,AUTO  
Auto Step Size Rules,Points per RBW,Points per RBW,Points per RBW,Points per RBW,Points per RBW,Points per RBW,Points per RBW,Points per RBW,Points per RBW,Points per RBW,Points per RBW,Points per RBW  
Pts/RBW,2,2,2,2,2,2,2,2,2,2,2,2  
Log %,10,10,10,10,10,10,10,10,10,10,10  
Atten,10,10,10,10,10,10,10,10,10,10,10  
Int Preamp,OFF,OFF,OFF,OFF,OFF,OFF,OFF,OFF,OFF,OFF,OFF  
RF Input,Input1,Input1,Input1,Input1,Input1,Input1,Input1,Input1,Input1,Input1

---

## Meas Results

Pressing this key selects Meas Result as the data type to be exported with a save request. The next step is to select the Save As key in the Save Data menu. You are given the flexibility to choose what to display in the report.

Key Path	Save, Data
<b>Remote Command</b>	:MMEMory:STORe:RESults <filename>
<b>Example</b>	:MMEM:STOR:RES "C:\My Documents\EMI\data\report1.html" exports the measurement result to the file report1.html
Notes	The default path is at "My Documents\EMI\data\FSCAN\Results\ If the save is initiated via SCPI, and the file already exists, the file and the directory will be overwritten. Using the C: drive is strongly discouraged, since it runs the risk of being overwritten during an instrument software upgrade. Both single and double quotes are supported for any filename parameter over SCPI.
Initial S/W Revision	A.10.00

## Trace

Enables you to customize the trace related information to be added into the report.

Key Path	Save, Data, Meas Result
Initial S/W Revision	A.10.00

### Header On/Off

Enables you to choose whether or not to show Trace Header information in the report.

Key Path	Save, Data, Meas Result, Trace
<b>Remote Command</b>	:MMEMory:RESults:TRACe:HEADer ON OFF 0 1 :MMEMory:RESults:TRACe:HEADer?
<b>Example</b>	:MMEM:RES:TRAC:HEAD ON
Preset	Not part of Preset, but is reset to ON by Restore Mode Defaults; survives Shutdown.
State Saved	Saved in instrument state
Range	On Off
Initial S/W Revision	A.10.00

### Setting On/Off

Enables you to choose whether or not to show trace setting in the report.

Key Path	Save, Data, Meas Result, Trace
<b>Remote Command</b>	:MMEMory:RESults:TRACe:SETTing ON OFF 0 1 :MMEMory:RESults:TRACe:SETTing?
<b>Example</b>	:MMEM:RES:TRAC:SETT ON
Preset	Not part of Preset, but is reset to ON by Restore Mode Defaults; survives Shutdown.
State Saved	Saved in instrument state
Range	On Off
Initial S/W Revision	A.10.00

### Trace Data On/Off

Enables you to choose whether or not to show trace data in the report.

Key Path	Save, Data, Meas Result, Trace
<b>Remote Command</b>	:MMEMory:RESults:TRACe:DATA ON OFF 0 1 :MMEMory:RESults:TRACe:DATA?
<b>Example</b>	:MMEM:RES:TRAC:DATA ON
Preset	Not part of Preset, but is reset to OFF by Restore Mode Defaults; survives Shutdown.
State Saved	Saved in instrument state
Range	On Off
Initial S/W Revision	A.10.00

## Edit Header

This key enables you to edit the trace file header information.

Key Path	Save, Export Data, Meas Result, Trace
Initial S/W Revision	A.10.00

## Title

Provides a title of up to 200 characters by which you can easily identify the Trace. The descriptions will be stored in the exported Trace file as a title and can be displayed in the active function area by selecting them as the active function, if desired to be in a screen capture.

Key Path	Save, Export Data, Meas Result, Trace, Edit Header
<b>Remote Command</b>	:MMEMory:TRACe:TITLe "string" :MMEMory:TRACe:TITLe? :MMEMory:TRACe:TITLe:STATe ON OFF 1 0 :MMEMory:TRACe:TITLe:STATe?
<b>Example</b>	:MMEM:TRAC:TITL "Advanced Company EMC Report" :MMEM:TRAC:TITL:STAT ON
Preset	"" (null String), not affected by Mode Preset, preset by Restore Mode Defaults.
State Saved	Saved in instrument state
Initial S/W Revision	A.10.00

## Client

Provides the Client information of up to 100 characters. The descriptions will be stored in the exported Trace file as a Client field and can be displayed in the active function area by selecting them as the active function, if desired to be in a screen capture.

Key Path	Save, Export Data, Meas Result, Trace, Edit Header
<b>Remote Command</b>	:MMEMory:TRACe:CLient "string" :MMEMory:TRACe:CLient? :MMEMory:TRACe:CLient:STATe ON OFF 1 0 :MMEMory:TRACe:CLient:STATe?
<b>Example</b>	:MMEM:TRAC:CLI "XYZ Corp Limited" :MMEM:TRAC:CLI:STAT ON
Preset	"" (null String), not affected by Mode Preset, preset by Restore Mode Defaults.
State Saved	Saved in instrument state
Initial S/W Revision	A.10.00

### Operator

Provides the Operator information of up to 100 characters. The descriptions will be stored in the exported Trace file as an Operator field and can be displayed in the active function area by selecting them as the active function, if desired to be in a screen capture.

<b>Key Path</b>	Save, Export Data, Meas Result, Trace, Edit Header
<b>Remote Command</b>	:MMEMory:TRACe:OPERator "string" :MMEMory:TRACe:OPERator? :MMEMory:TRACe:OPERator:STATe ON OFF 1 0 :MMEMory:TRACe:OPERator:STATe?
<b>Example</b>	:MMEM:TRAC:OPER "XYZ" :MMEM:TRAC:OPER:STAT ON
<b>Preset</b>	"" (null String), not affected by Mode Preset, preset by Restore Mode Defaults.
<b>State Saved</b>	Saved in instrument state
<b>Initial S/W Revision</b>	A.10.00

### Product Description

Provides the Product Description information of up to 100 characters. The descriptions will be stored in the exported Trace file as a Product Description field and can be displayed in the active function area by selecting them as the active function, if desired to be in a screen capture.

<b>Key Path</b>	Save, Export Data, Meas Result, Trace, Edit Header
<b>Remote Command</b>	:MMEMory:TRACe:PDEscription "string" :MMEMory:TRACe:PDEscription? :MMEMory:TRACe:PDEscription:STATe ON OFF 1 0 :MMEMory:TRACe:PDEscription:STATe?
<b>Example</b>	:MMEM:TRAC:PDES "Model ABC" :MMEM:TRAC:PDES:STAT ON
<b>Preset</b>	"" (null String), not affected by Mode Preset, preset by Restore Mode Defaults.
<b>State Saved</b>	Saved in instrument state
<b>Initial S/W Revision</b>	A.10.00

### Amplitude Correction Display

Enables you to choose whether to show only the file name and description or the complete data.

<b>Key Path</b>	Save, Data, Meas Result
<b>Remote Command</b>	:MMEMory:RESults:CORRection:MODE OFF DESCription DATA :MMEMory:RESults:CORRection:MODE?



<b>Example</b>	:MMEM:RES:CORR:MODE DATA
Notes	OFF= Off DESCRiption= Description and comment only DATA= Full data
Preset	Not part of Preset, but is reset to DESCRiption by Restore Mode Defaults; survives shutdown.
State Saved	Saved in instrument state
Range	Off Description and comment only Full Data
Readback Text	Off Desc & Comment Full Data
Initial S/W Revision	A.10.00

### Limits Display State

Enables you to choose whether to show only the file name and description or the complete data.

Key Path	Save, Data, Meas Result, Amp Corr
<b>Remote Command</b>	:MMEMory:RESults:LIMits:MODE OFF DESCRiption DATA :MMEMory:RESults:LIMits:MODE?
<b>Example</b>	:MMEM:RES:LIM:MODE DATA
Notes	OFF= Off DESCRiption= Description and comment only DATA= Full data
Preset	Not part of Preset, but is reset to DESCRiption by Restore Mode Defaults; survives shutdown.
State Saved	Saved in instrument state
Range	Off Description and comment only Full Data
Readback Text	Off Desc & Comment Full Data
Initial S/W Revision	A.10.00

### Screen State

Enables you to choose the color theme of screen image in report. You are given the option to turn this On/Off.

Key Path	Save, Data, Meas Result, Screen
<b>Remote Command</b>	:MMEMory:RESults:SCReen:THEME OFF FCOLOR TDCOLOR :MMEMory:RESults:SCReen:THEME?
<b>Example</b>	:MMEM:RES:SCR:THEM FCOL :MMEM:RES:SCR:THEM?
Preset	Not part of Preset, but is reset to FCOLOR by Restore Mode Defaults; survives shutdown.

State Saved	Saved in instrument state
Range	Off Flat Color 3D Color
Initial S/W Revision	A.10.00

### Scan Table On/Off

Enables you to choose whether or not to show Scan Table information in the report.

Key Path	Save, Data, Meas Result, Scan Table
<b>Remote Command</b>	:MMEMory:RESults:SCAN ON OFF 0 1 :MMEMory:RESults:SCAN?
<b>Example</b>	:MMEM:RES:SCAN ON
Preset	Not part of Preset, but is reset to ON or by Restore Mode Defaults; survives shutdown.
State Saved	Saved in instrument state
Range	On Off
Initial S/W Revision	A.10.00

### Signal List On/Off

Enables you to choose whether or not to show Signal List information in the report.

Key Path	Save, Data, Meas Result, Signal List
<b>Remote Command</b>	:MMEMory:RESults:SLISt ON OFF 0 1 :MMEMory:RESults:SLISt?
<b>Example</b>	:MMEM:RES:SLIS ON
Preset	Not part of Preset, but is reset to ON or by Restore Mode Defaults; survives shutdown.
State Saved	Saved in instrument state
Range	On Off
Initial S/W Revision	A.10.00

### Output Format

Enables user to select the output format of Meas Result. If the Output Format is set to HTML, a .html file will be saved and a directory that contains the .png file for the screen image will be created. If the Output Format is set to PDF, a .pdf file will be saved.

Key Path	Save, Data, Meas Result
<b>Remote Command</b>	:MMEMory:RESults:OUTPut HTML PDF :MMEMory:RESults:OUTP?

<b>Example</b>	:MMEM:RES:OUTP PDF
Preset	Not part of Preset, but is reset to HTML by Restore Mode Defaults; survives shutdown.
State Saved	Saved in instrument state
Range	HTML PDF
Readback Text	HTML PDF
Initial S/W Revision	A.13.00

## Save As . . .

When you press “Save As”, the analyzer brings up a Windows dialog and a menu entitled “**Save As.**” This menu allows you to navigate to the various fields in the Windows dialog without using a keyboard or mouse. The Tab and Arrow keys can also be used for dialog navigation.

See ["To File . . ." on page 1096](#) in Save, State for a full description of this dialog and menu.

The default path for saving files is:

For all of the Trace Data Files:

My Documents\`<mode name>`\data\traces

For all of the Limit Data Files:

My Documents\`<mode name>`\data\limits

For all of the Measurement Results Data Files:

My Documents\`<mode name>`\data\`<measurement name>`\results

For all of the Capture Buffer Data Files:

My Documents\`<mode name>`\data\captureBuffer

<b>Key Path</b>	Save, Data
Mode	All
Notes	The key location is mode-dependent and will vary. Brings up the Save As dialog for saving a <code>&lt;mode specific&gt;</code> Save Type. The save is performed immediately and does not wait until the measurement is complete.
Initial S/W Revision	Prior to A.02.00

## Screen Image

Pressing Screen Image accesses a menu of functions that enable you to specify a format and location for the saved screen image. It brings up a menu that allows you to specify the color scheme of the Screen Image (Themes) or navigate to the Save As dialog to perform the actual save.

Screen Image files contain an exact representation of the analyzer display. They cannot be loaded back onto the analyzer, but they can be loaded into your PC for use in many popular applications.

## 8 Frequency Scan Measurement

### Save

The image to be saved is actually captured when the Save front panel key is pressed, and kept in temporary storage to be used if you ask for a Screen Image save. When the Screen Image key is pressed, a "thumbnail" of the captured image is displayed, as shown below:

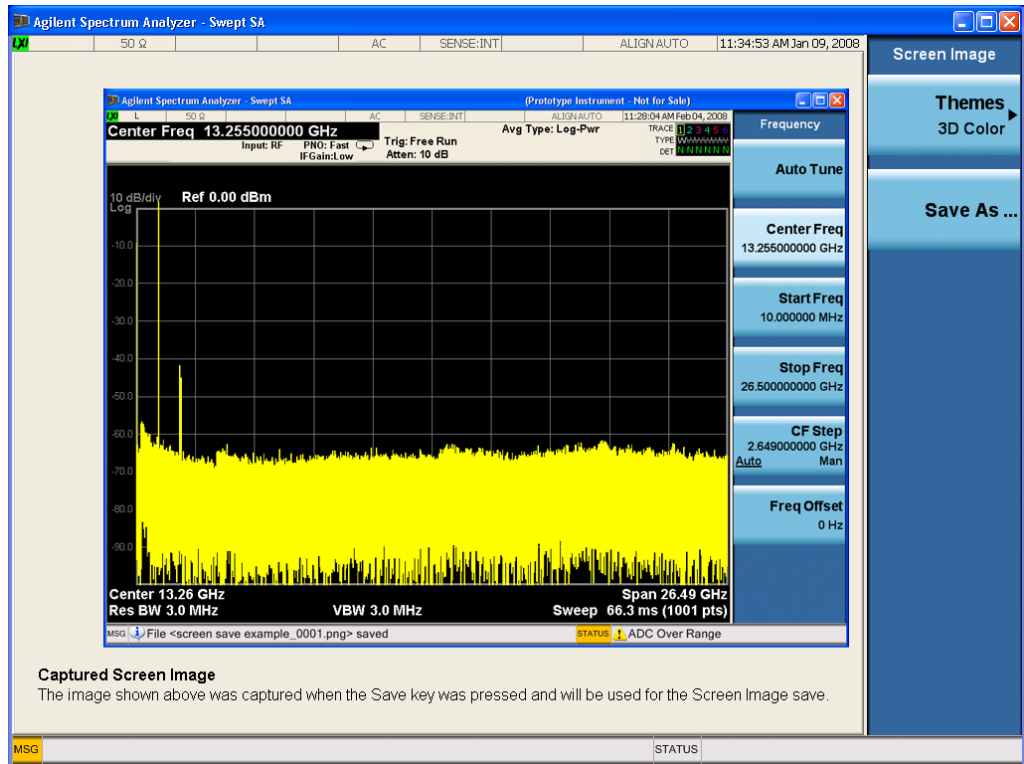

When you continue on into the Save As menu and complete the Screen Image save, the image depicted in the thumbnail is the one that gets saved, showing the menus that were on the screen before going into the Save menus. The save is performed immediately and does not wait until the measurement is complete.

After you have completed the save, the Quick Save front-panel key lets you quickly repeat the last save performed, using an auto-named file, with the current screen data.

#### NOTE

For versions previous to A.01.55, if you initiate a screen image save by navigating through the Save menus, the image that is saved will contain the Save menu softkeys, not the menus and the active function that were on the screen when you first pressed the Save front panel key.

Key Path	Save
Mode	All
Remote Command	:MMEMory:STORe:SCReen <filename>
Example	:MMEM:STOR:SCR "myScreen.png" This stores the current screen image in the file MyScreenFile.png in the default directory.
Initial S/W Revision	Prior to A.02.00

## Themes

Accesses a menu of functions that enable you to choose the theme to be used when saving the screen image.

The **Themes** option is the same as the **Themes** option under the **Display** and **Page Setup** dialogs. It allows you to choose between themes to be used when saving the screen image.

<b>Key Path</b>	Save, Screen Image
<b>Remote Command</b>	:MMEMory:STORe:SCReen:THEMe TDColor   TDMonochrome   FCOlor   FMONochrome  :MMEMory:STORe:SCReen:THEMe?
<b>Example</b>	:MMEM:STOR:SCR:THEM TDM
<b>Preset</b>	3D Color; Is not part of Preset, but is reset by Restore Misc Defaults or Restore System Defaults All and survives subsequent running of the modes.
<b>Readback</b>	3D Color   3D Mono   Flat Color   Flat Mono
<b>Backwards Compatibility Notes</b>	In ESA and PSA we offer the choice of "Reverse Bitmap" or "Reverse Metafile" when saving screen images. This is much like the "Flat Color" theme available in X-Series. Also, if you selected Reverse Bitmap AND a black & white screen image, that would be much like "Flat Monochrome". In other words, each of the X-Series themes has a similar screen image type in ESA/PSA. But they are not identical.
<b>Initial S/W Revision</b>	Prior to A.02.00

### 3D Color

Selects a standard color theme with each object filled, shaded and colored as designed.

<b>Key Path</b>	Save, Screen Image, Themes
<b>Example</b>	MMEM:STOR:SCR:THEM TDC
<b>Readback</b>	3D Color
<b>Initial S/W Revision</b>	Prior to A.02.00

### 3D Monochrome

Selects a format that is like 3D color but shades of gray are used instead of colors.

<b>Key Path</b>	Save, Screen Image, Themes
<b>Example</b>	MMEM:STOR:SCR:THEM TDM
<b>Readback</b>	3D Mono
<b>Initial S/W Revision</b>	Prior to A.02.00

### Flat Color

Selects a format that is best when the screen is to be printed on an ink printer.

Key Path	Save, Screen Image, Themes
<b>Example</b>	MMEM:STOR:SCR:THEM FCOL
Readback	Flat Color
Initial S/W Revision	Prior to A.02.00

### Flat Monochrome

Selects a format that is like Flat Color. But only black is used (no colors, not even gray), and no fill.

Key Path	Save, Screen Image, Themes
<b>Example</b>	MMEM:STOR:SCR:THEM FMON
Readback	Flat Mono
Initial S/W Revision	Prior to A.02.00

### Save As...

When you press "Save As", the analyzer brings up a Windows dialog and a menu entitled "Save As." This menu allows you to navigate to the various fields in the Windows dialog without using a keyboard or mouse. The Tab and Arrow keys can also be used for dialog navigation.

See "To File . . ." on page 1096 in Save, State for a full description of this dialog and menu.

The default path for Screen Images is

My Documents\`<mode name>`\screen.

where `<mode name>` is the parameter used to select the mode with the INST:SEL command (for example, SA for the Spectrum Analyzer).

Key Path	Save, Screen Image
Notes	Brings up Save As dialog for saving a Screen Image Save Type
Initial S/W Revision	Prior to A.02.00

### Mass Storage Catalog (Remote Command Only)

Key path	SCPI Only
<b>Remote Command</b>	:MMEMory:CATalog? [ <code>&lt;directory_name&gt;</code> ]
Notes	The string must be a valid logical path. Queries disk usage information (drive capacity, free space available) and obtains a list of files and directories in a specified directory in the following format: <code>&lt;numeric_value&gt;,&lt;numeric_value&gt;,{&lt;file_entry&gt;}</code> It returns two numeric parameters and as many strings as there are files and directories. The first

parameter indicates the total amount of storage currently used in bytes. The second parameter indicates the total amount of storage available, also in bytes. The <file\_entry> is a string. Each <file\_entry> indicates the name, type, and size of one file in the directory list:

<file\_name>,<file\_type>,<file\_size>

As the windows file system has an extension that indicates file type, <file\_type> is always empty. <file\_size> provides the size of the file in bytes. For directories, <file\_entry> is surrounded by square brackets and both <file\_type> and <file\_size> are empty

---

Initial S/W Revision      Prior to A.02.00

---

### Mass Storage Change Directory (Remote Command Only)

---

Key path                      SCPI Only

**Remote Command**        :MMEMory:CDIRectory [<directory\_name>]  
                                  :MMEMory:CDIRectory?

**Notes**                      The string must be a valid logical path.  
  
Changes the default directory for a mass memory file system. The <directory\_name> parameter is a string. If no parameter is specified, the directory is set to the \*RST value.  
At \*RST, this value is set to the default user data storage area, that is defined as System.Environment.SpecialFolder.Personal.  
Query returns full path of the default directory.

---

Initial S/W Revision      Prior to A.02.00

---

### Mass Storage Copy (Remote Command Only)

---

Key path                      SCPI Only

**Remote Command**        :MMEMory:COPY <string>,<string> [,<string>,<string>]

**Notes**                      The string must be a valid logical path.  
  
Copies an existing file to a new file or an existing directory to a new directory.  
Two forms of parameters are allowed. The first form has two parameters. In this form, the first parameter specifies the source, and the second parameter specifies the destination.  
The second form has four parameters. In this form, the first and third parameters specify the source. The second and fourth parameters specify the directories. The first pair of parameters specifies the source. The second pair specifies the destination. An error is generated if the source doesn't exist or the destination file already exists.  
  
This command will generate an "access denied" error if the destination is a restricted folder (e.g., C:\Windows) and the current user does not have Power User or Administrator privileges.

### Mass Storage Device Copy (Remote Command Only)

This command transfers data to/from a file and a peripheral device.

Key path	SCPI Only
<b>Remote Command</b>	:MMEMory:COpy:DEvice <source_string>,<dest_string>
Notes	<p>The strings must be a valid logical path or a valid device keyword. If the dest_string is a device keyword, the data is copied from the source file to the device. If the source_string is a device keyword, the data is copied to the source file from the device.</p> <p>Valid device keywords are: SNS (smart noise source)</p> <p>An error is generated if the file or device is not found.</p>

### Mass Storage Delete (Remote Command Only)

Key path	SCPI Only
<b>Remote Command</b>	:MMEMory:DELeTe <file_name>[,<directory_name>]
Notes	<p>The string must be a valid logical path.</p> <p>Removes a file from the specified directory. The &lt;file_name&gt; parameter specifies the file name to be removed. This command will generate an “access denied” error if the file is in a restricted folder (e.g., C:\Windows) and the current user does not have Power User or Administrator privileges.</p>
Initial S/W Revision	Prior to A.02.00

### Mass Storage Data (Remote Command Only)

Creates a file containing the specified data OR queries the data from an existing file.

Key path	SCPI Only
<b>Remote Command</b>	:MMEMory:DATA <file_name>, <data> :MMEMory:DATA? <file_name>
Notes	<p>The string must be a valid logical path.</p> <p>The command form is MMEMory:DATA &lt;file_name&gt;,&lt;data&gt;. It loads &lt;data&gt; into the file &lt;file_name&gt;. &lt;data&gt; is in 488.2 block format. &lt;file_name&gt; is string data.</p> <p>The query form is MMEMory:DATA? &lt;file_name&gt; with the response being the associated &lt;data&gt; in block format.</p>
Initial S/W Revision	Prior to A.02.00

### Mass Storage Make Directory (Remote Command Only)

Key path	SCPI Only
<b>Remote Command</b>	:MMEMory:MDIRectory <directory_name>
Notes	<p>The string must be a valid logical path.</p> <p>Creates a new directory. The &lt;directory_name&gt; parameter specifies the name to be created.</p>



	This command will generate an “access denied” error if the new directory would be in a restricted folder (e.g., C:\Windows) and the current user does not have Power User or Administrator privileges.
Initial S/W Revision	Prior to A.02.00

### Mass Storage Move (Remote Command Only)

Key path	SCPI Only
<b>Remote Command</b>	:MMEMory:MOVE <string>,<string>[,<string>,<string>]
Notes	<p>The string must be a valid logical path.</p> <p>Moves an existing file to a new file or an existing directory to a new directory.</p> <p>Two forms of parameters are allowed. The first form has two parameters. In this form, the first parameter specifies the source, and the second parameter specifies the destination.</p> <p>The second form has four parameters. In this form, the first and third parameters specify the source. The second and fourth parameters specify the directories. The first pair of parameters specifies the source. The second pair specifies the destination. An error is generated if the source doesn't exist or the destination file already exists.</p> <p>This command will generate an “access denied” error if the destination is a restricted folder (e.g., C:\Windows) and the current user does not have Power User or Administrator privileges.</p>
Initial S/W Revision	Prior to A.02.00

### Mass Storage Remove Directory (Remote Command Only)

Key path	SCPI Only
<b>Remote Command</b>	:MMEMory:RDIRECTory <directory_name>
Notes	<p>The string must be a valid logical path.</p> <p>Removes a directory. The &lt;directory_name&gt; parameter specifies the directory name to be removed. All files and directories under the specified directory shall also be removed.</p> <p>This command will generate an “access denied” error if the folder is a restricted folder (e.g., C:\Windows) or is in a restricted folder and the current user does not have Power User or Administrator privileges.</p>
Initial S/W Revision	Prior to A.02.00

## Single

Sets the Frequency Scan for single operation. See "[Continuous/ Single Scan](#) " on page 573 for more information.

If you are already in single scan, pressing Single key has no effect.

If a scan sequence is in Scan only and no active scan is running, pressing the Single key starts a new scan.

Key Path	Front-panel key
Initial S/W Revision	A.07.00

## Source

There is no Source control functionality for this measurement. When this key is pressed, the screen either displays a blank menu, or the previously-selected menu remains unchanged.

---

Key Path	Front-panel key
----------	-----------------

---

## SPAN X Scale

Displays the menu keys that enable you to control the span parameters. The only function in this menu is Span, which controls the Span of the display.

Key Path	Front-panel key
Notes	Front panel only.
Initial S/W Revision	A.07.00

### Span

Sets the span of the graticule display.

Key Path	SPAN X Scale
<b>Remote Command</b>	[ :SENSe ] :FREQuency:SPAN <frequency> [ :SENSe ] :FREQuency:SPAN?
<b>Example</b>	FREQ:SPAN 140 MHZ FREQ:SPAN?
Notes	Max values are depending on Hardware Options (503, 507, 508, 513, 526)
Dependencies	TheSpan can be limited by Start or Stop Freq limits, if the Midscreen Frequency is such that Start or Stop hit their limit.
Preset	970 MHz
State Saved	Saved in instrument state.
Min	10 Hz
Max	Depends on the instrument maximum frequency – 10 Hz minimum span. If the knob or step keys are being used, it depends on the value of other three interdependent parameters Mid-screen Frequency, Start Frequency and Stop Frequency.
Default Unit	Hz
Status Bits/OPC dependencies	non-overlapped
Initial S/W Revision	A.08.00

## Sweep/ Control

Displays the menu of keys that enable you to control the sweep parameters.

Key Path	Front-panel key
Notes	Front panel only.
Initial S/W Revision	A.07.00

### Continuous/ Single Scan

This key determines whether the scan is continuous or single. The scan will not start until you manually initiate the scanning through the Start or Clear List and Start key.

Key Path	Sweep/Control
<b>Remote Command</b>	INITiate2:CONTInuous ON OFF 1 0 INITiate2:CONTInuous?
<b>Example</b>	INIT2:CONT ON
Dependencies	When a Scan Only scan is running, changing this parameter to single will finish the current scan and stop. When the scan sequence = Scan Only, and no scan is running, changing this parameter will start a scan.  When a scan sequence other than Scan Only is running, changing this parameter will have no impact on the measurement. The scan will always be single in this case
Couplings	For single scanning: When the specified # of scans is complete, the scan will stop. Any parameter change before the scans complete will restart the scans (Scan number recount from zero). Any parameter change after the scans complete will NOT restart the scans. You need to manually start the scan.  For continues scanning: When the specified # of scans completes, it continues to scan with exponential averaging/ holds. Any parameter change after the scans complete will NOT restart the scans. You need to manually start the scan.
Preset	ON
State Saved	Saved in instrument state.
Range	ON OFF
Initial S/W Revision	A.07.00

### Pause / Resume

Allows you to pause the scan, search or final measurement. When paused, the label on the key changes to Resume. Pressing the Resume key resumes the scan at the point it was at when paused. A scan can only be paused between ranges.

Key Path	Sweep/ Control
----------	----------------

<b>Remote Command</b>	:INITiate:PAUSE
<b>Example</b>	INIT:PAUS
<b>Couplings</b>	When paused, the label on the key changes to "Resume".
<b>Backwards Compatibility SCPI</b>	:HOLD
<b>Backwards Compatibility SCPI Notes</b>	The command above is included for ESU compatibility.
<b>Initial S/W Revision</b>	A.07.00

<b>Key Path</b>	Sweep/ Control
<b>Remote Command</b>	:INITiate:RESume
<b>Example</b>	INIT:RES
<b>Couplings</b>	When resumed, the label on the key changes to "Pause".
<b>Backwards Compatibility SCPI</b>	:INITiate[1] 2:CONMeas.
<b>Backwards Compatibility SCPI Notes</b>	This command is included for ESU compatibility. The suffix [1]2 is irrelevant to the measurement, they are added solely for remote language compatibility.
<b>Initial S/W Revision</b>	A.07.00

## Start/ Stop

Allows you to start the scan, search or final measurement depending on the scan sequence selected. When started, the label on the key changes to Stop. The meters display would turn off during scanning and a final measurement. Pressing Stop will stop the current scan sequence and meters detector will be started automatically.

<b>Key Path</b>	Softkey: Sweep/ControlHardkey: Restart
<b>Remote Command</b>	INITiate2:IMMediate INITiate2:REStart
<b>Example</b>	INIT2:IMMINIT2:REST
<b>Notes</b>	This command is remote language compatible with ESU.
<b>Couplings</b>	When started, the label on the key changes to Stop.
<b>Initial S/W Revision</b>	A.07.00

<b>Key Path</b>	Sweep/ Control
<b>Remote Command</b>	[ :SENSe] :FSCan:SCAN:ABORt
<b>Example</b>	FSC:SCAN:ABOR

Couplings	When stopped, the label on the key changes to Start.
<b>Backwards Compatibility SCPI</b>	:ABORt
Backwards Compatibility SCPI Notes	This SCPI is remote language compatible with ESU.
Initial S/W Revision	A.07.00

## Clear List and Start

This key will perform the following when pressed:

1. Prompt you for confirmation to delete all signals in signal list with the following message:

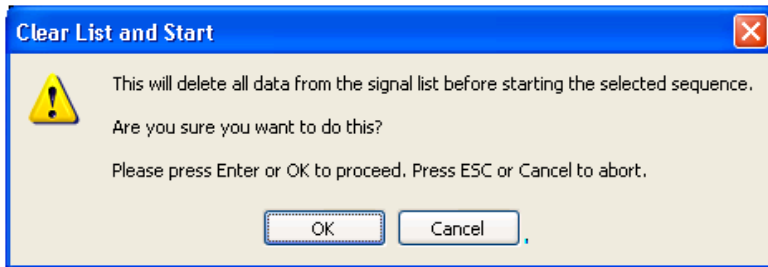

2. After confirmation, performs the selected scan sequence. This will turn the label on the Start key to Stop. If the selected Scan Sequence is Scan, and the scan is set to continuous, you need to stop the measurement with the Stop key. For all other cases, the scan sequence will stop when the measurement has completed.

Key Path	Sweep/Control
<b>Remote Command</b>	INITiate:FSCan:CLEar:IMMediate
<b>Example</b>	INIT:FSC:CLE:IMM
Dependencies	This key is disabled in two conditions: 1.A Scan sequence is running. If the grayed out key is pressed, an advisory message is generated. If the equivalent SCPI command is sent, this same message is generated as part of a “-221, Settings conflict” warning. 2.A Scan Sequence is set to Remeasure. If the grayed out key is pressed, an advisory message is generated. If the equivalent SCPI command is sent, this same message is generated as part of a “-221, Settings conflict” warning.
Initial S/W Revision	A.07.00

## Single (Meters)

Performs a single measurement at meters.

Key Path	Sweep/Control
----------	---------------

<b>Remote Command</b>	INITiate[1]:CONTinuous OFF
<b>Example</b>	INIT:CONT 0; INIT:IMM
<b>Dependencies</b>	This key is grayed out when a scan sequence is running. If the grayed out key is pressed, an advisory message is generated. If the equivalent SCPI command is sent, this same message is generated as part of a “-221, Settings conflict” warning.
<b>Couplings</b>	Meters will do a single measurement and stop. You can start the meters by changing the setting to continuous, or by sending the remote command INIT:IMM .
<b>Initial S/W Revision</b>	A.07.00

### Continuous (Meters)

Performs a continuous measurement at meters.

<b>Key Path</b>	Sweep/Control
<b>Remote Command</b>	INITiate[1]:CONTinuous ON
<b>Example</b>	INIT:CONT 1
<b>Dependencies</b>	This key is grayed out when a scan sequence is running. If the grayed out key is pressed, an advisory message is generated. If the equivalent SCPI command is sent, this same message is generated as part of a “-221, Settings conflict” warning.
<b>Couplings</b>	Meters will do measurements continuously, until you change the setting to single or a scan sequence is started.
<b>Initial S/W Revision</b>	A.07.00

### Restart Meters (Remote Command Only)

Allows you to restart the meters measurement when set to single.

<b>Remote Command</b>	INITiate[1]:IMMEDIATE INITiate[1]:RESTART
<b>Example</b>	INIT:IMMINIT:REST
<b>Notes</b>	This command is remote language compatible with ESU.
<b>Initial S/W Revision</b>	A.07.00



## System

See "System" on page 272

## Trace/ Detector

Displays the menu keys that enable you to control the trace setting.

Key Path	Front-panel key
Notes	Front panel only.
Initial S/W Revision	A.07.00

### Select Trace

Specifies the selected trace. The “selected trace” is the trace that other parameters under the Trace/Detector menu will apply to.

Key Path	Trace/ Detector
Notes	Front panel only. The selected trace is remembered even when not in the Trace/ Det Menu.
Preset	Trace 1.
State Saved	Saved in instrument state.
Initial S/W Revision	A.07.00

### Clear Write

In Clear Write type each trace update replaces the old data in the trace with new data. When Clear Write is pressed for one trace, the data for that trace will be cleared.

Key Path	Trace/Detector
<b>Example</b>	TRAC:FSC:TYPE WRIT
Dependencies	This key is grayed out when a scan sequence is running except during single range scanning. If the grayed out key is pressed, an advisory message is generated. If the equivalent SCPI command is sent, this same message is generated as part of a “-221, Settings conflict” warning.
Couplings	Whenever you press Clear Write or send the equivalent remote command, Update is set to On and Display is set to On.
Preset	After a Preset, any trace that is in Trace Average is cleared (all trace points set to mintracevalue).
State Saved	Saved in instrument state.
Initial S/W Revision	A.07.00

### Trace Average

In Trace Average type the analyzer maintains and displays an average trace, which represents the cumulative average on a point-by-point basis of the new trace data and previous averaged trace data.

Key Path	Trace/Detector
<b>Example</b>	TRAC:FSC:TYPE AVER
Dependencies	This key is grayed out when a scan sequence is running except during single range scanning. If the grayed out key is pressed, an advisory message is generated. If the equivalent remote command is sent, this same message is generated as part of a “-221, Settings conflict” warning.
Couplings	Affected by # of Scans (Avg Number). Whenever you press Average or send the equivalent remote command, Update is set to On and Display is set to On.
Preset	After a Preset, any trace that is in Trace Average is cleared (all trace points set to mintracevalue).
State Saved	Saved in instrument state.
Initial S/W Revision	A.07.00

## Max Hold

In Max Hold type the analyzer maintains and displays a max hold trace, which represents the maximum data value on a point-by-point basis of the new trace data and previous trace data.

Key Path	Trace/Detector
<b>Example</b>	TRAC:FSC:TYPE MAX
Dependencies	This key is grayed out when a scan sequence is running except during single range scanning. If the grayed out key is pressed, an advisory message is generated. If the equivalent remote command is sent, this same message is generated as part of a “-221, Settings conflict” warning.
Couplings	Affected by # of Scans (Avg Number). Whenever you press Max Hold or send the equivalent remote command, Update is set to On and Display is set to On.
Preset	After a Preset, any trace that is in Max Hold is cleared (all trace points set to mintracevalue).
State Saved	Saved in instrument state.
Initial S/W Revision	A.07.00

## Min Hold

In Min Hold type the analyzer maintains and displays a min hold trace, which represents the minimum data value on a point-by-point basis of the new trace data and previous trace data.

Key Path	Trace/Detector
<b>Example</b>	TRAC:FSC:TYPE MIN
Dependencies	This key is grayed out when a scan sequence is running except during single range scanning. If the grayed out key is pressed, an advisory message is generated. If the equivalent remote command is sent, this same message is generated as part of a “-221, Settings conflict” warning.

Couplings	Affected by # of Scans (Avg Number). Whenever you press Min Hold or send the equivalent remote command, Update is set to On and Display is set to On.
Preset	After a Preset, any trace that is in Min Hold is cleared (all trace points set to mintracevalue).
State Saved	Saved in instrument state.
Initial S/W Revision	A.07.00

<b>Remote Command</b>	:DISPlay[:WINDow]:TRACe[1] 2 3:MODE WRITe   VIEW   MAXHold   MINHold
<b>Example</b>	DISP:TRAC3:MODE MAXH Turn on trace 3, and set it to max hold.
Notes	WRITe alias TRAC:FSC:TYPE WRIT VIEW alias TRAC:FSC:DISP ON MAXHold alias TRAC:FSC:TYPE MAX MINHold alias TRAC:FSC:TYPE MIN This SCPI is Meas Local and Context Sensitive.
<b>Backwards Compatibility SCPI</b>	:DISPlay:WINDow1 WINDow2:TRACe[1] 2 3:MODE
Initial S/W Revision	A.07.00

<b>Remote Command</b>	:DISPlay[:WINDow]:TRACe[1] 2 3:MODE?
<b>Example</b>	DISP:TRAC3:MODE?
Notes	The query will be supported but will return WRITe = Clear Write AVERage = Trace Average MAXHold = Maximum Hold MINHold = Minimum Hold
<b>Backwards Compatibility SCPI</b>	:DISPlay:WINDow1 WINDow2:TRACe[1] 2 3:MODE?
Initial S/W Revision	A.07.00

## View/Blank

This key enables you to set the state of the two trace variables, Update and Display. The four choices available in this 1-of-N menu are:

- Trace On: Update and Display both On
- View: Update Off and Display On
- Blank: Update Off and Display Off

- Background: Update On, Display Off (this allows a trace to be blanked and continue to update “in the background”)

Key Path	Trace/Detector
Notes	<p>The four states of this 1-of-N actually set two variables, Update and Display, to their four possible combinations:</p> <p>Trace On: Update and Display both On View: Update Off and Display On Blank: Update Off and Display Off Background: Update On, Display Off</p> <p>See the following tables, "<a href="#">Trace Update State (Remote Command Only)</a>" on page 581 and "<a href="#">Trace Display State (Remote Command Only)</a>" on page 581, for details on the SCPI to control these two variables.</p>
Couplings	<p>Selecting a trace type (Clear Write, Trace Average, Max Hold, Min Hold) for a trace (pressing the key or sending the equivalent remote command) puts the trace in Trace On (Update On and Display On), even if that trace type was already selected.</p> <p>Selecting a detector for a trace (pressing the key or sending a [:SENS]:DET:TRAC command) puts the trace in Trace On (Update On and Display On), even if that detector was already selected.</p> <p>Loading a trace from a file puts that trace in View regardless of the state it was in when it was saved; as does being the target of a Copy or a participant in an Exchange.</p> <p>When a View/ Blank selection is made, the menu returns to the previous menu.</p>
Readback Text	Trace On View Blank Background
Initial S/W Revision	A.07.00

### Trace Update State (Remote Command Only)

Toggles the trace update state.

<b>Remote Command</b>	:TRACe [1]   2   3 :FSCan:UPDate ON OFF 1 0 :TRACe [1]   2   3 :FSCan:UPDate?
<b>Example</b>	FSC:TRAC2:UPD 0 Makes trace 2 inactive (stops updating). FSC:TRAC2:UPD Query update state of trace 2.
Couplings	Whenever you set Update to On for any trace, the Display is set to On for that trace.
Preset	1 0 0 (On for Trace 1; Off for 2-3)
State Saved	Saved in instrument state
Initial S/W Revision	A.07.00

### Trace Display State (Remote Command Only)

Toggle the trace display state.

<b>Remote Command</b>	:TRACe [1]   2   3 :FSCan:DISPlay ON OFF 1 0
-----------------------	--

	:TRACe[1] 2 3:FSCan:DISPlay ?
<b>Example</b>	FSC:TRAC2:DISP Makes trace 2 visible. FSC:TRAC:DISP Query display state of trace 1.
<b>Notes</b>	This function could have been implemented as an On/Off function, but we wanted to preserve the legacy “blank” nomenclature. The remote command is implemented as Display on/off.
<b>Couplings</b>	Whenever you set Update to On for any trace, the Display is set to On for that trace.
<b>Preset</b>	1 0 0 (On for Trace 1; Off for 2–3)
<b>State Saved</b>	Saved in instrument state.
<b>Initial S/W Revision</b>	A.07.00

## Detector (Trace)

Chooses detector type for the selected trace.

<b>Key Path</b>	Trace/Detector												
<b>Remote Command</b>	[[:SENSe]:FSCan:DETECTOR:TRACe[1]   2   3 POSitive   QPEak   EAverage   RAVerage   AVERage   NEGative [:SENSe]:FSCan:DETECTOR:TRACe[1] 2 3?												
<b>Example</b>	:FSC:DET:TRAC2 EAV Set Trace 2 to use EMI Average detector. :FSC:DET:TRAC3? Query detector type of trace 3.												
<b>Notes</b>	When Analog Out for Output Config is set to Screen Video/ Demod Audio, only Trace 1 will return the valid measurement result. Trace 2 & 3 will return -1000dBm if they are turned on. When a detector selection is made, the menu returns to the previous menu. The query returns a name that corresponds to the detector type as shown below, and indicates the setting for Trace 1.												
	<table border="1"> <tr> <td>POS</td> <td>Positive peak</td> </tr> <tr> <td>QPE</td> <td>Quasi Peak</td> </tr> <tr> <td>EAV</td> <td>EMI Average</td> </tr> <tr> <td>RAV</td> <td>RMS Average</td> </tr> <tr> <td>AVER</td> <td>Average</td> </tr> <tr> <td>NEG</td> <td>Negative peak</td> </tr> </table>	POS	Positive peak	QPE	Quasi Peak	EAV	EMI Average	RAV	RMS Average	AVER	Average	NEG	Negative peak
POS	Positive peak												
QPE	Quasi Peak												
EAV	EMI Average												
RAV	RMS Average												
AVER	Average												
NEG	Negative peak												
<b>Dependencies</b>	This key is grayed out during multi range scanning. If the grayed out key is pressed, an advisory message is generated. If the equivalent SCPI command is sent, this same message is generated as part of a “-221, Settings conflict; Function not available while running multirange scan” warning. This key is grayed out during final measurement. If the grayed out key is pressed, an advisory message is generated. If the equivalent SCPI command is sent, this same message is generated as part of a “-221, Settings conflict” warning. If an EMI detector (QPD or EMI Average or RMS Average) is already selected for two of the detectors, then the other EMI detector is grayed out. For example, if Detector 1 is QPD and Detector 2 is EMI												

Average, then for Detector 3, RMS Average is grayed out. If the grayed out key is pressed, an advisory message is generated. If the equivalent remote command is sent, this same message is generated as part of a “-221, Settings conflict” warning.

The Average detector and EMI detector are mutual exclusive. If an Average detector is selected, the other three EMI Detectors are grayed out on the other two traces, and vice visa. If an EMI Detector has been selected on another trace that is turned off when the Average detector is selected, the detector for that trace will be changed to Peak detector automatically. If the grayed out key is pressed, an advisory message is generated. If the equivalent remote command is sent, this same message is generated as part of a “-221, Settings conflict” warning.

Couplings	Selecting any CISPR detector on any active trace sets the EMI Standard to CISPR. Voltage averaging will be used.
Preset	POSitive
State Saved	Saved in instrument state.
Range	POSitive Quasi Peak EMI Average RMS Average Average Negative
Initial S/W Revision	A.07.00

## Peak

This sets the detector for the currently selected trace to Peak. For each bucket (interval) in the trace, Peak detection displays the highest amplitude within the bucket.

Key Path	Trace/Detector, Detector
<b>Example</b>	FSC:DET:TRAC2 POS Sets the detector to peak for trace 2.
Couplings	Selecting a detector for a trace (pressing the key or sending a [:SENS]:FSC:DET:TRAC command) puts Update On and Display On for that trace, even if that detector was already selected.
Initial S/W Revision	A.07.00

## Quasi Peak

This sets the detector for the currently selected trace to Quasi Peak. This is a fast-rise, slow-fall detector used in making CISPR compliant EMI measurements and defined by CISPR Publication 16-1-1. Quasi-peak detection displays a weighted, sample-detected amplitude using specific, charge, discharge, and meter time constants derived from the legacy behaviors of analog detectors and meters. It is used for EMI measurements to provide a specific and consistent response to EMI-like signals.

Key Path	Trace/Detector, Detector
<b>Example</b>	FSC:DET:TRAC3 QPE Selects the quasi-peak detector for trace 3.
Couplings	If the you select this detector on any active trace, the EMI Standard will be set to CISPR. If any inactive trace with this detector selected goes active, the EMI Standard is set to CISPR. Selecting a detector for a trace (pressing the key or sending a [:SENS]:FSC:DET:TRAC command) puts Update On and Display On for that trace, even if that detector was already selected.
Initial S/W Revision	A.07.00

## EMI Average

This sets the detector for the currently selected trace to EMI Average. Unlike the regular Average detector, the EMI Average detection displays the average value of the amplitude envelope, rather than the average value of the

sample-detected amplitude. It is defined for EMI measurements by the CISPR 16-1-1 standard and, in the X-series,

uses a sophisticated algorithm to implement a lowpass filter that conforms to the latest CISPR standard.

<b>Key Path</b>	Trace/Detector, Detector
<b>Example</b>	FSC:DET:TRAC3 EAV Selects the EMI average detector for trace 3.
<b>Couplings</b>	If the you select this detector on any active trace, the EMI Standard will be set to CISPR. If any inactive trace with this detector selected goes active, the EMI Standard is set to CISPR. Selecting a detector for a trace (pressing the key or sending a [:SENS]:FSC:DET:TRAC command) puts Update On and Display On for that trace, even if that detector was already selected.
<b>Initial S/W Revision</b>	A.07.00

## RMS Average

This sets the detector for the currently selected trace to RMS Average, a frequency dependent RMS/Averaging filter, used in making CISPR compliant EMI measurements. This filter conforms to the 2007 revision of the CISPR 16-1-1 standard.

This detector does one averaging process (in the VBW hardware) on the power (RMS) scale and another process on the voltage scale using a meter movement simulator similar to the one used in the QPD filter.

<b>Key Path</b>	Trace/Detector, Detector
<b>Example</b>	FSC:DET:TRAC3:RAV Selects the RMS Average detector for trace 3.
<b>Couplings</b>	If the user selects this detector on any active trace, the EMI Standard will be set to CISPR. If any inactive trace with this detector selected goes active, the EMI Standard is set to CISPR. Selecting a detector for a trace (pressing the key or sending a [:SENS]:FSC:DET:TRAC command) puts Update On and Display On for that trace, even if that detector was already selected.
<b>Initial S/W Revision</b>	A.07.00

## Average

This sets the detector for the currently selected trace to Average. For each bucket (interval) in the trace, Average detection displays the average of the amplitude within the bucket using Voltage envelope.

<b>Key Path</b>	Trace/Detector, Detector
<b>Example</b>	FSC:DET:TRAC2 AVER Sets the detector to peak for trace 2.



Couplings	Selecting a detector for a trace (pressing the key or sending a [:SENS]:FSC:DET:TRAC command) puts Update On and Display On for that trace, even if that detector was already selected.
Initial S/W Revision	A.07.00

## Negative Peak

This sets the detector for the currently selected trace to Negative Peak. For each bucket (interval) in the trace, Negative Peak detection displays the lowest sample within the bucket. The Negative peak detection is similar to peak detection, but selects the minimum video signal.

Key Path	Trace/Detector, Detector
<b>Example</b>	FSC:DET:TRAC2 NEG Sets the detector to peak for trace 2.
Couplings	Selecting a detector for a trace (pressing the key or sending a [:SENS]:FSC:DET:TRAC command) puts Update On and Display On for that trace, even if that detector was already selected.
Initial S/W Revision	A.07.00

## Copy/Exchange

This menu lets you copy any trace to any other trace, or exchange any trace with any other trace.

The X Axis settings and domain of a trace go with it when it is copied or exchanged.

Key Path	Trace/Detector
Initial S/W Revision	A.07.00

## From Trace

Selects the trace to be copied to or exchanged with the To Trace.

Key Path	Trace/Detector, Copy/Exchange
Preset	1
State Saved	Saved in instrument state.
Initial S/W Revision	A.07.00

## To Trace

Selects the trace to be copied from or exchanged with the From Trace.

Key Path	Trace/Detector, Copy/Exchange
Preset	2

State Saved	Saved in instrument state.
Initial S/W Revision	A.07.00

## Copy Now

Executes the Copy operation and puts the destination trace in Update=Off, Display=On.

Key Path	Trace/Detector, Copy/Exchange
Remote Command	:TRACe:FSCan:COpy TRACE1   TRACE2   TRACE3, TRACE1   TRACE2   TRACE3
Example	TRAC:FSC:COpy TRACE1, TRACE3 Copies Trace 1 to Trace 3 and puts Trace 3 in Update=Off, Display=On.
Notes	The TRACe:FSCan:COpy command is of the form: :TRACe:FSCan:COpy <source_trace>,<dest_trace> In the case of a Copy, the destination trace is put in Update=Off, Display=On after the copy. In the case of an Exchange, both traces are put into Update=Off, Display=On after the exchange.
Dependencies	This key is grayed out when a scan sequence is running. If the grayed out key is pressed, an advisory message is generated. If the equivalent SCPI command is sent, this same message is generated as part of a “-221, Settings conflict” warning.
Initial S/W Revision	A.07.00

## Exchange Now

Executes the Exchange operation and puts both traces in Update=Off, Display=On.

Key Path	Trace/Detector, Copy/Exchange
Remote Command	:TRACe:FSCan:EXCHange TRACE1   TRACE2   TRACE3, TRACE1   TRACE2   TRACE3
Example	TRAC:FSC:EXCH TRACE1, TRACE2 Exchanges Trace 1 and Trace 2 and puts both traces in Update=Off, Display=On.
Notes	The TRACe:FSCan:EXCHange command is of the form: :TRACe:FSCan:EXCHange <trace_1>,<trace_2>
Dependencies	This key is grayed out when a scan sequence is running. If the grayed out key is pressed, an advisory message is generated. If the equivalent SCPI command is sent, this same message is generated as part of a “-221, Settings conflict” warning.
Initial S/W Revision	A.07.00

## Send/Query Trace Data (Remote Command Only)

This command allows trace data to be sent to the instrument or queried from the instrument. The response to the query is a list of amplitude points that comprise the requested trace in the current Y Axis Unit of the analyzer. The X Axis Unit is that of the destination trace (for send) or the source trace (for query).

<b>Remote Command</b>	:TRACe:FSCan[:DATA] TRACE1   TRACE2   TRACE3, <data>
<b>Example</b>	TRAC:FSC TRACE1, -1, -2, -3, -4, -5 Sends five points to Trace 1. Assuming that FORMat:DATA is set to ASCII, Y Axis Unit is set to dBm, and sweep points is set to 5, this will result in Trace 1 consisting of the five points -1 dBm, -2 dBm, -3 dBm, -4 dBm, and -5 dBm.
Remote Command Notes	The TRACe[:DATA] command is of the form: :TRACe:DATA <trace>,<data> where <trace> can be one of the following parameters: TRACE1,TRACE2,TRACE3 and where <data> can be - ASCII data, which consists of a string of values separated by comma or - REAL or INTeger sent as a definite length block, with a header describing the data to follow.
Couplings	Sweep points will affect the amount of data The FORMat:DATA command describes the different types of data formats that can be used with trace data. Use the FORMat:BORDER command to set the byte order.
<b>Backwards Compatibility SCPI</b>	:TRACe[:DATA]
Backwards Compatibility SCPI Notes	This command is included for ESU compatibility. The command is Meas Local and Context Sensitive.
Initial S/W Revision	A.07.00

## Query Trace Data

<b>Remote Command</b>	:TRACe:FSCan[:DATA]? TRACE1   TRACE2   TRACE3  SCAN SINGle
<b>Example</b>	TRAC:FSC? TRACE2 Queries the analyzer for the contents of trace 2.
Remote Command Notes	When TRACE1, the latest contents of trace 1 will be returned. When TRACE2, the latest contents of trace 2 will be returned. When TRACE3, the latest contents of trace 3 will be returned. When SINGle, the current power values of all activated meters are returned separated by commas in the order meters number. When SCAN, the scan measurement result will be returned block by block depends on the scan settings. In order to use this query, user needs to send command TRACe:FEED:CONTRol ALWays. The structure of transmitted data:- 4 bytes: trace status where bit 12- last block 4 bytes: number n of the transmitted result for a trace (n depends on scan time) 4 bytes: Trace 1 update status (0 or 1) 4 bytes: Trace 2 update status (0 or 1) 4 bytes: Trace 3 update status (0 or 1) 4 bytes: 0 n* 4 bytes measurement results of trace 1 if trace 1 update is true; else return 0

	n* 4 bytes measurement results of trace 2 if trace 2 update is true; else return 0 n* 4 bytes measurement results of trace 3 if trace 3 update is true; else return 0
<b>Backwards Compatibility SCPI</b>	:TRACe[:DATA]?
Backwards Compatibility SCPI Notes	This command is included for ESU compatibility. The SCPI is Meas Local and Context Sensitive.
Initial S/W Revision	A.07.00

<b>Remote Command</b>	TRACe:FEED:CONTRol ALWays NEVer TRACe:FEED:CONTRol?
<b>Example</b>	TRAC:FEED:CONT ALW Allow block data transmission
Notes	This ESU command switches block data transmission during a scan on and off. The availability of data is reported in the bit 9 of STATus:OPERation-Register. The block size depends on scan time.
Preset	NEVer

### Backwards Compatibility SCPI commands

"Trace Display (Remote Command Only)" on page 588

"Detector Type (Remote Command Only)" on page 588

### Trace Display (Remote Command Only)

This SCPI sets the trace's Update state.

<b>Remote Command</b>	DISPlay[:WINDow]:TRACe[1] 2 3[:STATe] ON OFF 1 0 DISPlay[:WINDow]:TRACe[1] 2 3[:STATe]?
<b>Example</b>	DISP:TRAC OFF DISP:TRAC?
Notes	This command is included for ESU compatibility. The suffix [1]2 and [1]2 3 are irrelevant to the measurement, they are added solely for remote language compatibility. This SCPI alias to :TRACe[1] 2 3:FSCan:UPDate ON OFF 1 0.
<b>Backwards Compatibility SCPI</b>	DISPlay:WINDow[1] 2:TRACe[1] 2 3[:STATe]
Initial S/W Revision	A.07.00

### Detector Type (Remote Command Only)

Select the detector used for the selected trace.

<b>Remote Command</b>	[:SENSe]:DETector[1] 2 3[:FUNction] APEak   NEGative   POSitive   SAMPle   RMS   AVERage   QPEak   CAVerage   CRMS
-----------------------	---

[[:SENSe]:DETEctor[1]|2|3[:FUNction] ?

**Example** DET3 APE Set trace 3 to use Peak Detector.

**Notes** This command is included for ESU compatibility. The suffix [1]2 is irrelevant to the measurement, they are added solely for remote language compatibility.  
This command is alias to [:SENSe]:FSCan:DETEctor:TRACe[1]2|3 <DectectorTye>.

APEak/ POSitive/SAMPlE	Peak
NEGative	Negative
QPEak	Quasi Peak
AVERage	Average
CAVerage	EMI Average
RMS/ CRMS	RMS Average

The query will return:-  
 POSitive when Peak Trace Detector is selected.  
 AVER when Average is selected.  
 CAV when EMI Average is selected.  
 CRMS when RMS Average is selected.

**Preset** POSitive

**Backwards Compatibility SCPI** :SENSe1|SENSe2:DETEctor[1]|2|3[:FUNction]

**Initial S/W Revision** A.07.00

## Trigger

See ["Trigger" on page 358](#)

### Free Run

See ["Free Run " on page 365](#)

### Video

See ["Video \(IF Envelope\) " on page 366](#)

### Trigger Level

See ["Trigger Level " on page 366](#)

### Trig Slope

See ["Trig Slope " on page 367](#)

### Trig Delay

See ["Trig Delay " on page 368](#)

### External 1

See ["External 1 " on page 369](#)

### Trigger Level

See ["Trigger Level " on page 370](#)

### Trig Slope

See ["Trig Slope " on page 370](#)

### Trig Delay

See ["Trig Delay " on page 371](#)

### Zero Span Delay Comp

See ["Zero Span Delay Comp On/Off" on page 372](#)

### External 2

See ["External 2 " on page 372](#)

### Trigger Level

See ["Trigger Level " on page 373](#)

### Trig Slope

See ["Trig Slope " on page 373](#)

### **Trig Delay**

See "Trig Delay " on page 374

### **Zero Span Delay Comp**

See "Zero Span Delay Comp On/Off" on page 374

### **Auto/Holdoff**

See "Auto/Holdoff " on page 375

### **Auto Trig**

See "Auto Trig " on page 375

### **Trig Holdoff**

See "Trig Holdoff " on page 376

## User Preset

Accesses a menu that gives you the following three choices:

- User Preset – recalls a state previously saved using the Save User Preset function.
- User Preset All Modes – presets all of the modes in the analyzer
- Save User Preset– saves the current state for the current mode

Key Path	Front-panel key
Backwards Compatibility Notes	<p>User Preset is actually loading a state, and in legacy analyzers, it was possible to load a state without affecting the trace data, limit lines or correction data. Similarly it was possible to do a User Preset without affecting the trace data, limit lines or correction data.</p> <p>In the X-Series, “state” always includes all of this data; so whenever state is loaded, or User Preset is executed, all of the traces, limit lines and corrections are affected. Although this differs from previous behavior, it is desirable behavior, and should not cause adverse issues for users.</p> <p>On ESA and PSA, User Preset affected the entire instrument’s state. In the X-Series, User Preset only recalls the state for the active mode. There is a User Preset file for each mode. User Preset can never cause a mode switch as it can in legacy analyzers. If you want to recall all modes to their user preset file state, you will need to do a User Preset after mode switching into each mode.</p> <p>User Preset recalls mode state which can now include data like traces; whereas on ESA and PSA, User Preset did not affect data.</p>
Initial S/W Revision	Prior to A.02.00

## User Preset

User Preset sets the state of the currently active mode back to the state that was previously saved for this mode using the Save User Preset menu key or the SCPI command, SYST:PRES:USER:SAV. It not only recalls the Mode Preset settings, but it also recalls all of the mode persistent settings, and the Input/Output system setting that existed at the time Save User Preset was executed.

If a Save User Preset has not been done at any time, User Preset recalls the default user preset file for the currently active mode. The default user preset files are created if, at power-on, a mode detects there is no user preset file. There will never be a scenario when there is no user preset file to restore. For each mode, the default user preset state is the same state that would be saved if a Save User Preset is performed in each mode right after doing a Restore Mode Default and after a Restore Input/Output Defaults.

The User Preset function does the following:

- Aborts the currently running measurement.
- Sets the mode State to the values defined by Save User Preset.
- Makes the saved measurement for the currently running mode the active measurement.
- Brings up the saved menu for the power-on mode.
- Clears the input and output buffers.
- Sets the Status Byte to 0.



Key Path	User Preset
Remote Command	:SYSTem:PRESet:USER
Example	:SYST:PRES:USER:SAVE:SYST:PRES:USER
Notes	:SYST:PRES:USER:SAVE is used to save the current state as the user preset state. Clears all pending OPC bits. The Status Byte is set to 0. Pressing the User Preset front-panel key while already in the User Preset menu will cause the User Preset to get executed
Couplings	A user preset will cause the currently running measurement to be aborted and cause the saved measurement to be active. Recalling a User Preset file has the same issues that recalling a Save State file has. Some settings may need to be limited and therefore re-coupled, since the capabilities of the mode may have changes when the User Preset file was last saved.
Initial S/W Revision	Prior to A.02.00

## User Preset All Modes

Recalls all of the User Preset files for each mode, switches to the power-on mode, and activates the saved measurement from the power-on mode User Preset file.

### NOTE

When the instrument is secured, all of the user preset files are converted back to their default user preset files.

The User Preset function does the following:

- Aborts the currently running measurement.
- Switches the Mode to the power-on mode.
- Restores the User Preset files for each mode.
- Makes the saved measurement for the power-on mode the active measurement.
- Brings up the saved menu for the power-on mode.
- Clears the input and output buffers.
- Sets the Status Byte to 0.

Key Path	User Preset
Remote Command	:SYSTem:PRESet:USER:ALL
Example	:SYST:PRES:USER:SAVE:SYST:PRES:USER:ALL
Notes	Clears all pending OPC bits. The Status Byte is set to 0. :SYST:PRES:USER:SAVE is used to save the current state as the user preset state.
Couplings	A user preset will cause the currently running measurement to be aborted, cause a mode switch to the power-on mode, and cause the saved measurement to be active in the power-on mode. Recalling a User Preset file has the same issues that recalling a Save State file has. Some settings may need to be limited and therefore re-coupled, since the capabilities of the mode may have changes when the User Preset file was last saved.
Initial S/W Revision	Prior to A.02.00

## Save User Preset

Saves the currently active mode and its State. You can recall this User Preset file by pressing the User Preset menu key or sending the SYST:PRES:USER remote command. This same state is also saved by the Save State function.

Key Path	User Preset
Remote Command	:SYSTem:PRESet:USER:SAVE
Example	:SYST:PRES:USER:SAVE
Notes	:SYST:PRES:SAVE creates the same file as if the user requested a *SAV or a MMEM:STOR:STAT, except User Preset Save does not allow the user to specify the filename or the location of the file.
Initial S/W Revision	Prior to A.02.00

## View/ Display

Displays the menu keys that enable you to select the measurement view.

Key Path	Front-panel key
Notes	Front panel only.
Initial S/W Revision	A.07.00

## Display

The Display menu is common to most measurements, and is used for configuring items on the display. Some Display menu settings apply to all the measurements in a mode, and some only to the current measurement. Those under the System Display Settings key apply to all measurements in all modes.

Key Path	Display
Key Path	View/Display
Initial S/W Revision	Prior to A.02.00

## Annotation

Turns on and off various parts of the display annotation. The annotation is divided up into four categories:

1. Meas Bar: This is the measurement bar at the top of the screen. It does not include the settings panel or the Active Function. Turning off the Meas Bar turns off the settings panel and the Active Function. When the Meas Bar is off, the graticule area expands to fill the area formerly occupied by the Meas Bar.
2. Screen Annotation: this is the annotation and annunciation around the graticule, including any annotation on lines (such as the display line, the threshold line, etc.) This does NOT include the marker number or the N dB result. When off, the graticule expands to fill the entire graticule area.
3. Trace annotation: these are the labels on the traces, showing their detector (or their math mode).
4. Active Function annotation: this is the active function display in the meas bar, and all of the active function values displayed on softkeys.

See the figure below. Each type of annotation can be turned on and off individually.

8 Frequency Scan Measurement  
View/ Display

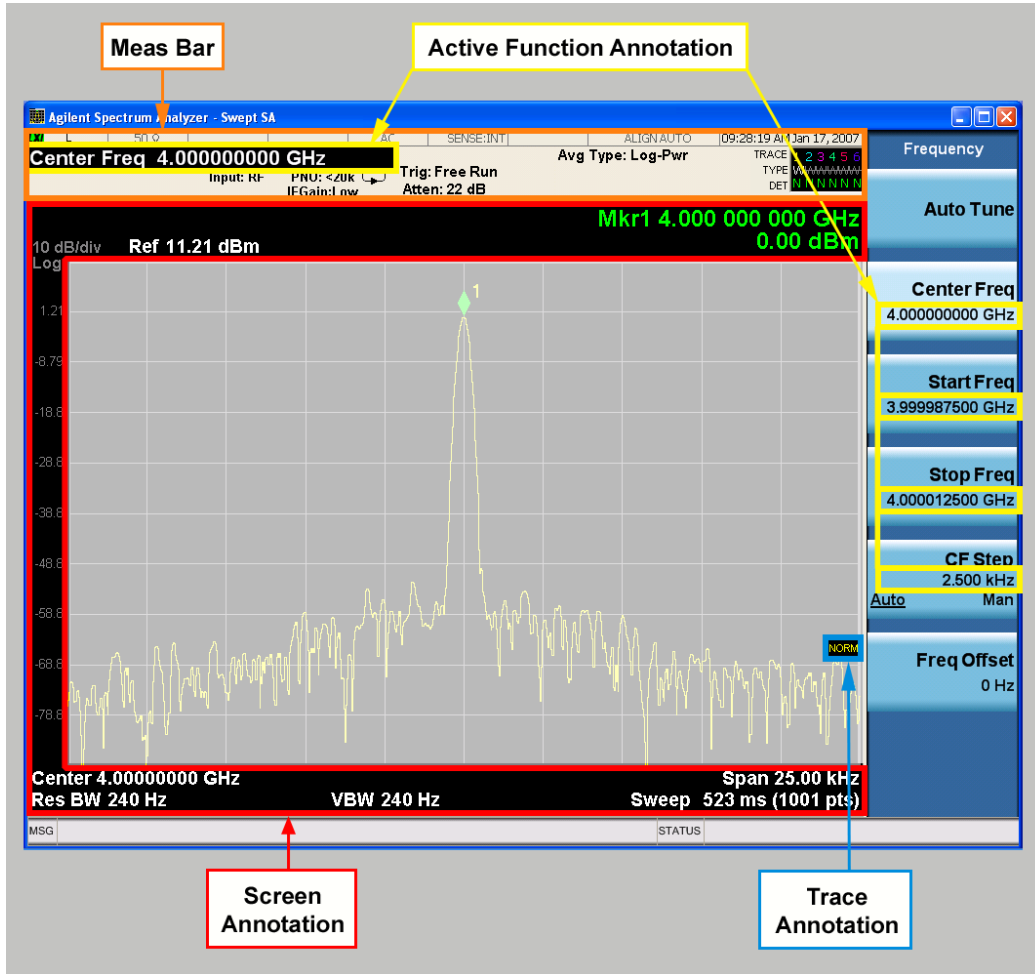

Key Path	View/Display, Display
Initial S/W Revision	Prior to A.02.00

Meas Bar On/Off

This function turns the Measurement Bar on and off, including the settings panel. When off, the graticule area expands to fill the area formerly occupied by the Measurement Bar.

Key Path	View/Display, Display, Annotation
Remote Command	:DISPlay:ANNOtation:MBAR[:STATe] OFF ON 0 1 :DISPlay:ANNOtation:MBAR[:STATe]?
Example	DISP:ANN:MBAR OFF
Dependencies	Grayed out and forced to OFF when System Display Settings, Annotation is set to Off.
Preset	On This should remain Off through a Preset when System DisplaySettings, Annotation is set to Off.
State Saved	Saved in instrument state.
Initial S/W Revision	Prior to A.02.00

## Screen

This controls the display of the annunciation and annotation around the graticule, including any annotation on lines (such as the display line, the threshold line, etc.) and the y-axis annotation. This does NOT include marker annotation (or the N dB result). When off, the graticule expands to fill the entire graticule area, leaving only the 1.5% gap above the graticule as described in the Trace/Detector chapter.

Key Path	View/Display, Display, Annotation
<b>Remote Command</b>	:DISPlay:ANNotation:SCReen[:STATe] OFF ON 0 1 :DISPlay:ANNotation:SCReen[:STATe]?
<b>Example</b>	DISP:ANN:SCR OFF
Dependencies	Grayed-out and forced to OFF when System Display Settings, Annotation is set to Off.
Preset	On This should remain Off through a Preset when System DisplaySettings, Annotation is set to Off
State Saved	Saved in instrument state.
Initial S/W Revision	Prior to A.02.00

## Trace

Turns on and off the labels on the traces, showing their detector (or their math mode) as described in the Trace/Detector section.

If trace math is being performed with a trace, then the trace math annotation will replace the detector annotation.

Key Path	View/Display, Display, Annotation
<b>Remote Command</b>	:DISPlay:ANNotation:TRACe[:STATe] ON OFF 1 0 :DISPlay:ANNotation:TRACe[:STATe]?
<b>Example</b>	DISP:ANN:TRAC OFF
Preset	Off
State Saved	Saved in instrument state.
Initial S/W Revision	Prior to A.02.00

## Active Function Values On/Off

Turns on and off the active function display in the Meas Bar, and all of the active function values displayed on the softkeys.

Note that all of the softkeys that have active functions have these numeric values blanked when this function is on. This is a security feature..

8 Frequency Scan Measurement  
View/ Display

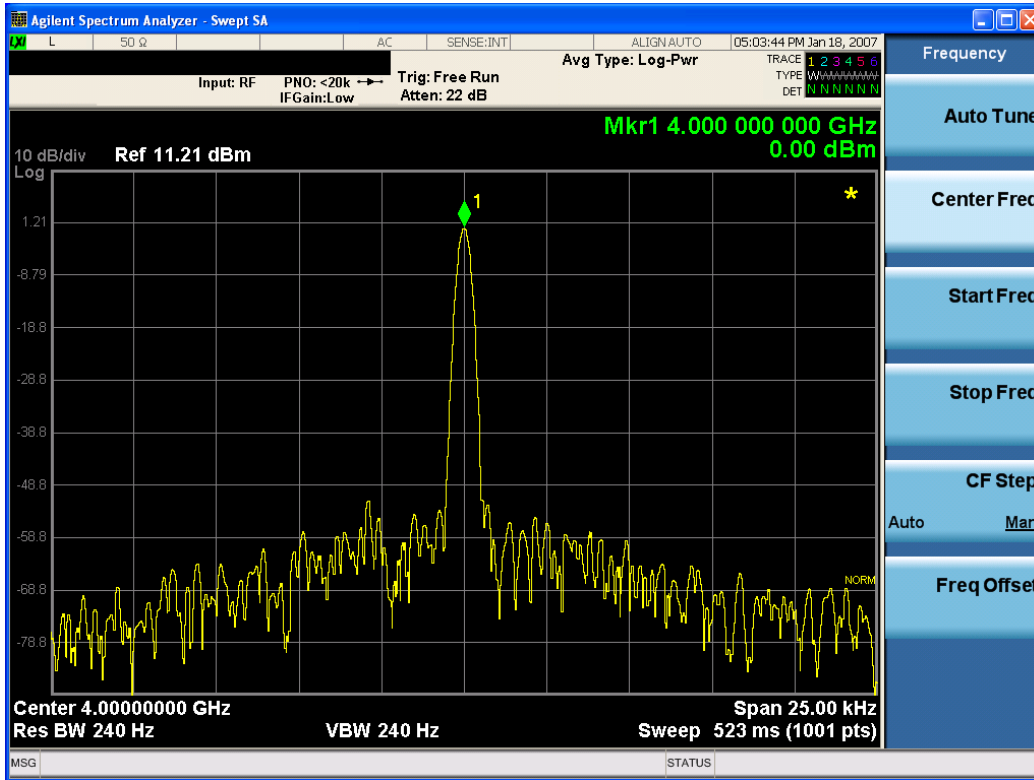

Key Path	View/Display, Display, Annotation
Remote Command	:DISPlay:ACTivefunc[:STATE] ON OFF 1 0 :DISPlay:ACTivefunc[:STATE]?
Example	DISP:ACT OFF
Dependencies	Grayed out and forced to OFF when System Display Settings, Annotation is set to Off.
Preset	On This should remain Off through a Preset when System DisplaySettings, Annotation is set to Off
State Saved	Saved in instrument state.
Initial S/W Revision	Prior to A.02.00

Title

Displays menu keys that enable you to change or clear a title on your display.

Key Path	View/Display, Display
Initial S/W Revision	Prior to A.02.00

Change Title

Writes a title into the "measurement name" field in the banner, for example, "Swept SA".

Press Change Title to enter a new title through the alpha editor. Press Enter or Return to complete the entry. Press ESC to cancel the entry and preserve your existing title.

The display title will replace the measurement name. It remains for this measurement until you press Change Title again, or you recall a state, or a Preset is performed. A title can also be cleared by pressing Title, Clear Title.

**NOTE**

Notice the inclusion of the <measurement> parameter in the command below. Because each measurement remembers the Display Title, the command must be qualified with the measurement name. For the Swept SA measurement this is not the case; no <measurement> parameter is used when changing the Display Title for the Swept SA measurement.

Key Path	View/Display, Display, Title
Mode	All
<b>Remote Command</b>	:DISPlay:<measurement>:ANNotation:TITLe:DATA <string> :DISPlay:<measurement>:ANNotation:TITLe:DATA?
<b>Example</b>	DISP:ANN:TITL:DATA "This Is My Title" This example is for the Swept SA measurement in the Spectrum Analyzer mode. The SANalyzer <measurement> name is not used. DISP:ACP:ANN:TITL:DATA "This Is My Title" This example is for Measurements other than Swept SA. Both set the title to: This Is My Title
Notes	Pressing this key cancels any active function. When a title is edited the previous title remains intact (it is not cleared) and the cursor goes at the end so that characters can be added or BKSP can be used to go back over previous characters.
Preset	No title (measurement name instead)
State Saved	Saved in instrument state.
Initial S/W Revision	Prior to A.02.00

**Clear Title**

Clears a title from the front-panel display. Once cleared, the title cannot be retrieved. After the title is cleared, the current Measurement Name replaces it in the title bar.

Key Path	View/Display, Display, Title
<b>Example</b>	The following commands clear the title and restore the measurement's original title: DISP:ANN:TITL:DATA "" This example is for the Swept SA measurement in the Spectrum Analyzer mode. The SANalyzer <measurement> name is not used. DISP:ACP:ANN:TITL:DATA "" This example is for ACP; in measurements other than Swept SA the measurement name is required.
Notes	Uses the :DISPlay:<measurement>:ANNotation:TITLe:DATA <string> command with an empty string (in the Swept SA, the <measurement> is omitted).
Preset	Performed on Preset.
Initial S/W Revision	Prior to A.02.00

## Graticule

Pressing Graticule turns the display graticule On or Off. It also turns the graticule y-axis annotation on and off.

Key Path	View/Display, Display
Remote Command	:DISPlay:WINDow[1]:TRACe:GRATicule:GRID[:STATe] OFF ON 0 1 :DISPlay:WINDow[1]:TRACe:GRATicule:GRID[:STATe]?
Example	DISP:WIND:TRAC:GRAT:GRID OFF
Notes	The graticule is the set of horizontal and vertical lines that make up the grid/divisions for the x-axis and y-axis.
Preset	On
State Saved	Saved in instrument state
Initial S/W Revision	Prior to A.02.00

## Display Line

Activates an adjustable horizontal line that is used as a visual reference line. The line's vertical position corresponds to its amplitude value. The value of the display line (for example, "-20.3 dBm") appears above the line itself on the right side of the display in the appropriate font.

The display line can be adjusted using the step keys, knob, or numeric keypad. The unit of the Display Line is determined by the **Y axis unit** setting under **Amplitude**. If more than one window has a display line, the display line of the selected window is controlled.

If the display line is off the screen, it shows as a line at the top/bottom of the screen with an arrow pointing up or down. As with all such lines (Pk Thresh, Trigger Level, etc.) it is drawn on top of all traces.

The display line is unaffected by Auto Couple.

Key Path	View/Display, Display
Remote Command	:DISPlay:WINDow[1]:TRACe:Y:DLINe <ampl> :DISPlay:WINDow[1]:TRACe:Y:DLINe? :DISPlay:WINDow[1]:TRACe:Y:DLINe:STATe OFF ON 0 1 :DISPlay:WINDow[1]:TRACe:Y:DLINe:STATe?
Example	DISP:WIND:TRAC:Y:DLIN:STAT ON DISP:WIND:TRAC:Y:DLIN:STAT -32 dBm
Preset	Set the Display Line to Off and -25 dBm on Preset. When the Display Line goes from Off to On, if it is off screen, set it to either the top or bottom of screen, depending on which direction off screen it was. The Display Line's value does not change when it is turned off.
State Saved	Saved in instrument state.
Min	-∞ (minus infinity) in current units
Max	+∞ (plus infinity) in current units



Default Unit	Depends on the current selected Y axis unit
Initial S/W Revision	Prior to A.02.00

## System Display Settings

These settings are "Mode Global" – they affect all modes and measurements and are reset only by Restore Misc Defaults or Restore System Defaults under System.

Key Path	View/Display, Display
Initial S/W Revision	Prior to A.02.00

## Annotation Local Settings

This is a Mode Global override of the meas local annotation settings. When it is All Off, it forces ScreenAnnotation, Meas Bar, Trace, and Active Function Values settings to be OFF for all measurements in all modes. This provides the security based "annotation off" function of previous analyzers; hence it uses the legacy SCPI command.

When it is All Off, the Screen, Meas Bar, Trace, and Active Function Values keys under the Display, Annotation menu are grayed out and forced to Off. When Local Settings is selected, you are able to set the local annotation settings on a measurement by measurement basis.

Key Path	View/Display, Display, System Display Settings
Remote Command	:DISPlay:WINDow[1]:ANNotation[:ALL] OFF ON 0 1 :DISPlay:WINDow[1]:ANNotation[:ALL]?
Example	:DISP:WIND:ANN OFF
Preset	On (Set by Restore Misc Defaults)
State Saved	Not saved in instrument state.
Backwards Compatibility Notes	The WINDow parameter and optional subopcode is included for backwards compatibility but ignored – all windows are equally affected.
Initial S/W Revision	Prior to A.02.00

## Themes

Accesses a menu of functions that enable you to choose the theme to be used when saving the screen image.

The **Themes** option is the same as the **Themes** option under the **Display** and **Page Setup** dialogs. It allows you to choose between themes to be used when saving the screen image.

Key Path	Save, Screen Image
Remote Command	:MMEMory:STORe:SCReen:THEMe TDColor   TDMonochrome   FColor   FMONochrome

	:MMEMory:STORe:SCR:THEMe?
<b>Example</b>	:MMEM:STOR:SCR:THEM TDM
Preset	3D Color; Is not part of Preset, but is reset by Restore Misc Defaults or Restore System Defaults All and survives subsequent running of the modes.
Readback	3D Color   3D Mono   Flat Color   Flat Mono
Backwards Compatibility Notes	In ESA and PSA we offer the choice of "Reverse Bitmap" or "Reverse Metafile" when saving screen images. This is much like the "Flat Color" theme available in X-Series. Also, if you selected Reverse Bitmap AND a black & white screen image, that would be much like "Flat Monochrome". In other words, each of the X-Series themes has a similar screen image type in ESA/PSA. But they are not identical.
Initial S/W Revision	Prior to A.02.00

### 3D Color

Selects a standard color theme with each object filled, shaded and colored as designed.

Key Path	Save, Screen Image, Themes
<b>Example</b>	MMEM:STOR:SCR:THEM TDC
Readback	3D Color
Initial S/W Revision	Prior to A.02.00

### 3D Monochrome

Selects a format that is like 3D color but shades of gray are used instead of colors.

Key Path	Save, Screen Image, Themes
<b>Example</b>	MMEM:STOR:SCR:THEM TDM
Readback	3D Mono
Initial S/W Revision	Prior to A.02.00

### Flat Color

Selects a format that is best when the screen is to be printed on an ink printer.

Key Path	Save, Screen Image, Themes
<b>Example</b>	MMEM:STOR:SCR:THEM FCOL
Readback	Flat Color
Initial S/W Revision	Prior to A.02.00

## Flat Monochrome

Selects a format that is like Flat Color. But only black is used (no colors, not even gray), and no fill.

Key Path	Save, Screen Image, Themes
<b>Example</b>	MMEM:STOR:SCR:THEM FMON
Readback	Flat Mono
Initial S/W Revision	Prior to A.02.00

## Backlight

Accesses the display backlight on/off keys. This setting may interact with settings under the Windows "Power" menu.

When the backlight is off, pressing ESC, TAB, SPACE, ENTER, UP, DOWN, LEFT, RIGHT, DEL, BKSP, CTRL, or ALT turns the backlight on without affecting the application. Pressing any other key will turn backlight on and could potentially perform the action as well.

Key Path	View/Display, Display, System Display Settings
<b>Remote Command</b>	:DISPlay:BACKlight ON OFF :DISPlay:BACKlight?
Preset	ON (Set by Restore Misc Defaults)
Initial S/W Revision	Prior to A.02.00

## Backlight Intensity

An active function used to set the backlight intensity. It goes from 0 to 100 where 100 is full on and 0 is off. This value is independent of the values set under the Backlight on/off key.

Key Path	View/Display, Display, System Display Settings
<b>Remote Command</b>	:DISPlay:BACKlight:INTensity <integer> :DISPlay:BACKlight:INTensity?
<b>Example</b>	DISP:BACK:INT 50
Preset	100 (Set by Restore Misc Defaults)
Min	0
Max	100
Initial S/W Revision	Prior to A.02.00

## Meters Display

Enables you to turn on/off the meters display. When ON and no scan or final measurement is running, the meters will take up the right side of the display. When OFF, the frequency scan expands to fill the entire

display area.

<b>Key Path</b>	View/ Display
<b>Remote Command</b>	:DISPlay:FSCan:VIEW:METer[:STATe] ON OFF 1 0 :DISPlay:FSCan:VIEW:METer[:STATe]?
<b>Example</b>	:DISP:FSC:VIEW:MET 1 :DISP:FSC:VIEW:MET?
<b>Preset</b>	ON
<b>State Saved</b>	Saved in instrument state.
<b>Initial S/W Revision</b>	A.07.00

### Meters Freq Line

When on, a blue vertical line showing the location of the meters frequency will appear on the frequency scan graph. In the signal list, the signal number is the same color as the Meters Freq Line when the Meters Freq is matched with the signal's frequency. Otherwise, the signal number is in white.

<b>Key Path</b>	View/ Display
<b>Remote Command</b>	:DISPlay:FSCan:VIEW:METer:FLINe ON OFF 1 0 :DISPlay:FSCan:VIEW:METer:FLINe?
<b>Example</b>	:DISP:FSC:VIEW:MET:FLIN 1 :DISP:FSC:VIEW:MET:FLIN?
<b>Dependencies</b>	The Frequency Line will only be shown if Meters Display is set to on and when a scan is not running.
<b>Preset</b>	ON
<b>State Saved</b>	Saved in instrument state.
<b>Initial S/W Revision</b>	A.07.00

### Next Range

This key allows you to switch across ranges on the scan trace to see the setting of the RBW, VBW, Attenuation, Int Preamp, Dwell Time, Step Size, Scan Time and Scan Points on the graph annotation and meas bars. The green color outline will be moved as you switch across the ranges on the trace. This key will do nothing for a single range scan, where the green outline will not be shown.

<b>Key Path</b>	View/ Display
<b>Notes</b>	Front panel only.

## 9 Strip Chart Measurement

The Strip Chart measurement is an EMI measurement for the X-Series platform that can be used for troubleshooting in CISPR pre-compliance and compliance test. The Strip Chart measurement is capable of measuring a signal in real time with three EMI detectors simultaneously. The Strip Chart measurement displays the real time measurement results in meters in a strip chart. The update rate for the Strip Chart measurement in both views is:

- Minimum 10 times per second
- Maximum 30 times per second

This topic contains the following sections:

["Measurement Commands for Strip Chart" on page 606](#)

["Remote Command Results " on page 607](#)

INITiate:Schart

CONFigure:Schart

CONFigure?

FETCh:Schart [n]?

MEASure:Schart [n]?

READ:Schart [n]?

## Measurement Commands for Strip Chart

The following commands are used to retrieve the measurement results:

---

<b>Remote Command</b>	:MEASure READ FETCh:SCHart[1] 2?
<b>Example</b>	MEAS:SCH? FETCh:SCH? READ:SCH?

---

## Remote Command Results

Command	N	Results Returned
INITiate:SCHart	n/a	n/a
CONFigure?	n/a	name of current measurement: " SCHart "
CONFigure:SCHart	n/a	n/a (selects Strip Chart measurement in Meas Preset state)
INITiate:SCHart	n/a	n/a (selects Strip Chart measurement without affecting settings)
FETCh:SCHart [n]? MEASure:SCHart [n]? READ:SCHart [n]?	Not specified or n=1	Return the following comma-separated scalar results: 1. Current measurement result of Meter 1 2. Current measurement result of Meter 2 3. Current measurement result of Meter 3 Note : Return NaN (9.91E37) if the Meter is not available.
	n=2	Return the following comma-separated scalar results: 1. Max measurement result of Meter 1 2. Max measurement result of Meter 2 3. Max measurement result of Meter 3 Note : Return NaN (9.91E37) if the Meter is not available.
	n=3	This query returns Trace 1 data as a list of x,y pairs. The y-values are in the current Y-Axis Unit of the analyzer. The x-axis values are the values of the trace, in the x-axis scale units of the trace (Hz for frequency domain traces, seconds for time domain traces).
	n=4	Returns Trace 2 data as a series of x,y pairs
	n=5	Returns Trace 3 data as a series of x,y pairs
Key Path	Meas	
Initial S/W Revision	A.07.00	

## AMPTD Y Scale

Displays the menu keys that enable you to control the amplitude parameters.

Key Path	Front-panel key
Notes	Front panel only.
Initial S/W Revision	A.07.00

### Reference Level

Specifies the amplitude represented by the topmost graticule line.

Key Path	AMPTD Y Scale
<b>Remote Command</b>	:DISPlay:Schart:VIEW[1]:WINDow[1]:TRACe:Y[:SCALe]:RLEVel <real> :DISPlay:Schart:VIEW[1]:WINDow[1]:TRACe:Y[:SCALe]:RLEVel?
<b>Example</b>	DISP:SCH:VIEW:WIND:TRAC:Y:RLEV 80 dBuV DISP:SCH:VIEW:WIND:TRAC:Y:RLEV?
Preset	106.99 dBuV
State Saved	Saved in instrument state.
Min	RefLevelMin = -63.01 dBuV + RefLevelOffset - ExtGain.
Max	RefLevelMax = 206.99 dBuV + RefLevelOffset - ExtGain
Default Unit	Depends on the current selected Y-axis unit
Initial S/W Revision	A.07.00

### Attenuation

Sets the value of Attenuation. Only the mechanical attenuator is available. For details about this key, see ["Attenuation" on page 896](#).

### Presel Center

For details about this key, see ["Presel Center" on page 897](#)

### Presel Adjust

For details about this key, see ["Preselector Adjust" on page 899](#)

### Y Axis Unit

Display the menu keys that enable you to change the vertical (Y) axis amplitude unit. For details about this key, see [Y Axis Unit@32002](#)



## Internal Preamp

This key works the same way in this and many other measurements, so it is documented in the Common Measurement Functions section. For more details on this key, see ["Internal Preamp" on page 905](#)

## Attenuation

Enables you to set the value of the Attenuation parameter. This key only affects the Mechanical Attenuator in the EMI Receiver mode and has no Auto setting.

For the Frequency Scan measurement, this key only affects the attenuation used for meters.

The following amplitude parameters are not settable by the user and therefore do not appear in any menus:

Elec Attenuator	Disabled
Elec Attenuation	0dB
Meas Atten Step	2dB
Max Mixer Level	-10dBm

Key Path	AMPTD Y Scale
<b>Remote Command</b>	<code>[ :SENSe ] :POWer [ :RF ] :ATTenuation &lt;rel_ampl&gt;</code> <code>[ :SENSe ] :POWer [ :RF ] :ATTenuation?</code>
<b>Example</b>	POW:ATT 10 POW:ATT?
Preset	10 dB
State Saved	Saved in instrument state.
Min	0 dB
Max	50 dB (CXA) 60 dB (EXA) 70 dB (MXA, PXA& N9038A)
Default Unit	dB
<b>Backwards Compatibility SCPI</b>	<code>:INPut [1]   2 :ATTenuation</code>
Backwards Compatibility SCPI Notes	This command above is included for ESU compatibility. The suffix [1] 2 is irrelevant to the measurement, they are added solely for remote language compatibility. This SCPI is Meas Local and Context Sensitive.
Initial S/W Revision	A.07.00

## Scale/ Div

Sets the units per division of the vertical scale in the logarithmic display.

Key Path	AMPTD Y Scale
Remote Command	:DISPlay:SCHart:VIEW[1]:WINDow[1]:TRACe:Y[:SCALe]:PDIVision <rel_ampl> :DISPlay:SCHart:VIEW[1]:WINDow[1]:TRACe:Y[:SCALe]:PDIVision?
Example	DISP:SCH:VIEW:WIND:TRAC:Y:PDIV 5 dB DISP:SCH:VIEW:WIND:TRAC:Y:PDIV?
Preset	10.00 dB
State Saved	Saved in instrument state
Min	0.10 dB
Max	20.00 dB
Initial S/W Revision	A.07.00

### Presel Center

When this key is pressed, the centering of the preselector filter is adjusted to optimize the amplitude accuracy at the frequency of the selected marker. If the selected marker is not on when Presel Center is pressed, the analyzer will turn on the selected marker, perform a peak search, and then perform centering on the marker's center frequency. If the selected marker is already on and between the start and stop frequencies of the analyzer, the analyzer performs the preselector calibration on that marker's frequency. If the selected marker is already on, but outside the frequency range between Start Freq and Stop Freq, the analyzer will first perform a peak search, and then perform centering on the marker's center frequency.

The value displayed on the Presel Adjust key will change to reflect the new preselector tuning (see Presel Adjust).

A number of considerations should be observed to ensure proper operation. See ["Proper Preselector Operation" on page 611](#).

Key Path	AMPTD Y Scale
Remote Command	[:SENSe]:POWer[:RF]:PCENter
Example	POW:PCEN
Notes	Note that the rules outlined above under the key description apply for the remote command as well as the key. The result of the command is dependent on marker position, and so forth. Any message shown by the key press is also shown in response to the remote command.
Dependencies	<ul style="list-style-type: none"> <li>• Grayed out if the microwave preselector is off. )</li> <li>• If the selected marker's frequency is below Band 1, advisory message 0.5001 is generated and no action is taken.</li> <li>• Grayed out if entirely in Band 0.</li> <li>• Blank in models that do not include a preselector, such as option 503. If the SCPI is sent in these instruments, it is accepted without error, and the query always returns 0.</li> <li>• Grayed out in the Spectrogram View.</li> </ul>
Couplings	The active marker position determines where the centering will be attempted.

	If the analyzer is in a measurement such as averaging when centering is initiated, the act of centering the preselector will restart averaging but the first average trace will not be taken until the centering is completed.
Status Bits/OPC dependencies	When centering the preselector, *OPC will not return true until the process is complete and a subsequent measurement has completed, nor will results be returned to a READ or MEASure command.  The Measuring bit should remain set while this command is operating and should not go false until the subsequent sweep/measurement has completed.
Initial S/W Revision	Prior to A.02.00
Modified at S/W Revision	A.03.00

### Proper Preselector Operation

A number of considerations should be observed to ensure proper operation:

1. If the selected marker is off, the analyzer will turn on a marker, perform a peak search, and adjust the preselector using the selected marker's frequency. It uses the "highest peak" peak search method unqualified by threshold or excursion, so that there is no chance of a 'no peak found' error. It continues with that peak, even if it is the peak of just noise. Therefore, for this operation to work properly, there should be a signal on screen in a preselected range for the peak search to find.
2. If the selected marker is already on, the analyzer will attempt the centering at that marker's frequency. There is no preselector for signals below about 3.6 GHz, therefore if the marker is on a signal below 3.6 GHz, no centering will be attempted and an advisory message generated
3. In some models, the preselector can be bypassed. If it is bypassed, no centering will be attempted in that range and a message will be generated.

### Preselector Adjust

Allows you to manually adjust the preselector filter frequency to optimize its response to the signal of interest. This function is only available when "[Presel Center](#)" on page 897 is available.

For general purpose signal analysis, using Presel Center is recommended. Centering the filter minimizes the impact of long-term preselector drift. Presel Adjust can be used instead to manually optimize the preselector. One application of manual optimization would be to peak the preselector response, which both optimizes the signal-to-noise ratio and minimizes amplitude variations due to small (short-term) preselector drifting.

Key Path	AMPTD Y Scale
Scope	Meas Global
Remote Command	<code>[ :SENSe ] :POWer [ :RF ] :PADJust &lt;freq&gt;</code> <code>[ :SENSe ] :POWer [ :RF ] :PADJust?</code>
Example	<code>POW:PADJ 100KHz</code> <code>POW:PADJ?</code>

Notes	The value on the key reads out to 0.1 MHz resolution.
Dependencies	<ul style="list-style-type: none"> <li>• Grayed out if microwave preselector is off. )</li> <li>• Grayed out if entirely in Band 0.</li> <li>• Blank in models that do not include a preselector, such as option 503. If the SCPI is sent in these instruments, it is accepted without error, and the query always returns 0.</li> <li>• Grayed out in the Spectrogram View.</li> </ul>
Preset	0 MHz
State Saved	The Presel Adjust value set by Presel Center, or by manually adjusting Presel Adjust, is not saved in instrument state, and does not survive a Preset or power cycle.
Min	-500 MHz
Max	500 MHz
Default Unit	Hz
<b>Backwards Compatibility SCPI</b>	<pre>[ :SENSe ] : POWer [ :RF ] : MW : PADJust</pre> <pre>[ :SENSe ] : POWer [ :RF ] : MMW : PADJust</pre> <p>PSA had multiple preselectors, but the X-Series has only one. These commands simply alias to [ :SENSe ] : POWer [ :RF ] : PADJust</p>
Initial S/W Revision	Prior to A.02.00
Modified at S/W Revision	A.03.00

<b>Remote Command</b>	<pre>[ :SENSe ] : POWer [ :RF ] : PADJust : PRESelector MWAVE   MMWave   EXTERNAL</pre> <pre>[ :SENSe ] : POWer [ :RF ] : PADJust : PRESelector?</pre>
Notes	<p>PSA had multiple preselectors, and you could select which preselector to adjust. Since the X-Series has only one mm/uW preselector, the preselector selection softkey is no longer available. However, to provide backward compatibility, we accept the legacy remote commands.</p> <p>The command form has no effect, the query always returns MWAVE</p>
Initial S/W Revision	Prior to A.02.00

## Y Axis Unit

Displays the menu keys that enable you to change the vertical (Y) axis amplitude unit. The analyzer retains the entered Y Axis Unit separately for both Log and Lin amplitude scale types. For example, if Scale Type has been set to Log, and you set Y Axis Unit to dBm, pressing Scale Type (Log) sets the Y Axis Unit to dBm. If Scale Type has been set to Lin and you set Y Axis Unit to V, pressing Scale Type (Lin) sets the Y Axis Unit to V. Pressing Scale Type (Log) again sets the Y axis unit back to dBm.

**NOTE**

The units of current (A, dBmA, dBuA) are calculated based on 50 ohms input impedance.

All four of the EMI units (dB $\mu$ A/m, dB $\mu$ V/m, dBG, dBpT) are treated by the instrument exactly as though they were dBuV. The user must load an appropriate correction factor using Amplitude Corrections for accurate and meaningful results.

If a SCPI command is sent to the analyzer that uses one of the EMI units as a terminator, the analyzer treats it as though DBUV had been sent as the terminator.

Key Path	AMPTD Y Scale
Mode	SA
Scope	Meas Global
Remote Command	:UNIT:POWer DBM   DBMV   DBMA   V   W   A   DBUV   DBUA   DBPW   DBUVM   DBUAM   DBPT   DBG  :UNIT:POWer?
Example	UNIT:POW dBmV UNIT:POW?
Notes	The Y axis unit has either logarithmic or linear characteristics. The set of units that is logarithmic consists of dBm, dBmV, dBmA, dB $\mu$ V, dB $\mu$ A, dB $\mu$ V/m, dB $\mu$ A/m, dBpT, and dBG. The set of units that are linear consists of V, W, and A. The chosen unit will determine how the reference level and all the amplitude-related outputs like trace data, marker data, etc. read out.
Notes	The settings of Y Axis Unit and Scale Type, affect how the data is read over the remote interface. When using the remote interface no unit is returned, so you must know what the Y axis unit is to interpret the results:  Example 1, set the following: Scale Type (Log) Y Axis Unit, dBm Scale/Div, 1 dB Ref Level, 10 dBm  This sets the top line to 10 dBm with each vertical division representing 1 dB. Thus, if a point on trace 1 is on the fifth graticule line from the top, it represents 5 dBm and will read out remotely as 5.  Example 2, set the following: Scale Type (Lin) Y Axis Unit, Volts Ref Level, 100 mV (10 mV/div)  This sets the top line to 100 mV and the bottom line to 0 V, so each vertical division represents 10 mV. Thus, if a point on trace 1 is on the fifth graticule line from the top, it represents 50 mV and will read out remotely as 50.
Dependencies	If an amplitude correction with an Antenna Unit other than None is applied and enabled, then that antenna unit is forced and the key with that unit is the only Y Axis Unit available. All other Y Axis Unit keys are grayed out.  If an amplitude correction with an Antenna Unit other than None is applied and enabled, and you then turn off that correction or set Apply Corrections to No, the Y Axis Unit that existed before the Antenna Unit was applied is restored.
Couplings	The analyzer retains the entered Y Axis Unit separately for both Log and Lin amplitude scale types

Preset	dBm for log scale, V for linear. The true 'preset' value is dBm, since at preset the Y Scale type is set to logarithmic.
State Saved	Saved in instrument state
Readback line	1-of-N selection
Initial S/W Revision	Prior to A.02.00
Modified at S/W Revision	A.02.00, A.04.00, A.11.00

### dBm

Sets the amplitude unit for the selected amplitude scale (log/lin) to dBm.

Key Path	AMPTD Y Scale, Y Axis Unit
<b>Example</b>	UNIT:POW DBM
Dependencies	Grayed out if an Amplitude Correction with an Antenna Unit is ON.
Readback	dBm
Initial S/W Revision	Prior to A.02.00
Modified at S/W Revision	A.02.00

### dBmV

Sets the amplitude unit for the selected amplitude scale (log/lin) to dBmV.

Key Path	AMPTD Y Scale, Y Axis Unit
<b>Example</b>	UNIT:POW DBMV
Dependencies	Grayed out if an Amplitude Correction with an Antenna Unit is ON.
Readback	dBmV
Initial S/W Revision	Prior to A.02.00
Modified at S/W Revision	A.02.00

### dBmA

Sets the amplitude unit for the selected amplitude scale (log/lin) to dBmA.

Key Path	AMPTD Y Scale, Y Axis Unit
<b>Example</b>	UNIT:POW DBMA
Dependencies	Grayed out if an Amplitude Correction with an Antenna Unit is ON.
Readback	dBmA
Initial S/W Revision	Prior to A.02.00
Modified at S/W Revision	A.02.00

## W

Sets the amplitude unit for the selected amplitude scale (log/lin) to watt.

Key Path	AMPTD Y Scale, Y Axis Unit
<b>Example</b>	UNIT:POW W
Dependencies	Grayed out if an Amplitude Correction with an Antenna Unit is ON.
Readback	W
Initial S/W Revision	Prior to A.02.00
Modified at S/W Revision	A.02.00

## V

Sets the amplitude unit for the selected amplitude scale (log/lin) to volt.

Key Path	AMPTD Y Scale, Y Axis Unit
<b>Example</b>	UNIT:POW V
Dependencies	Grayed out if an Amplitude Correction with an Antenna Unit is ON.
Readback	V
Initial S/W Revision	Prior to A.02.00
Modified at S/W Revision	A.02.00

## A

Sets the amplitude unit for the selected amplitude scale (log/lin) to Ampere.

Key Path	AMPTD Y Scale, Y Axis Unit
<b>Example</b>	UNIT:POW A
Dependencies	Grayed out if an Amplitude Correction with an Antenna Unit is ON.
Readback	A
Initial S/W Revision	Prior to A.02.00
Modified at S/W Revision	A.02.00

## dB $\mu$ V

Sets the amplitude unit for the selected amplitude scale (log/lin) to dB $\mu$ V.

Key Path	AMPTD Y Scale, Y Axis Unit
----------	----------------------------

<b>Example</b>	UNIT:POW DBUV
Dependencies	Grayed out if an Amplitude Correction with an Antenna Unit is ON.
Readback	dB $\mu$ V
Initial S/W Revision	Prior to A.02.00
Modified at S/W Revision	A.02.00

## dB $\mu$ A

Sets the amplitude unit for the selected amplitude scale (log/lin) to dB $\mu$ A.

### NOTE

The unit dBuA can also appear as an Antenna Unit. This will be used by customers using current probes, because current probes are often supplied with conversion tables that provide the transducer factors. When dBuA is used as an Antenna Unit the normal conversion from power to amps for dBuA (based on the analyzer input impedance) is not done, but instead the conversion is based solely on the Correction that contains the transducer factors. This is what distinguishes dBuA as a normal unit from dBuA as an antenna unit. When querying the Y-Axis unit, you can query the Antenna Unit to distinguish between regular dBuA and the dBuA antenna unit. If :CORR:CSET:ANT? returns NOC (for No Conversion), you are using a normal Y Axis dBuA. If it returns UA you are using an Antenna Unit dBuA.

Key Path	AMPTD Y Scale, Y Axis Unit
<b>Example</b>	UNIT:POW DBUA
Dependencies	Grayed out if an Amplitude Correction with an Antenna Unit is ON.
Readback	dB $\mu$ A
Initial S/W Revision	Prior to A.02.00
Modified at S/W Revision	A.02.00

## dBpW

Sets the amplitude unit for the selected amplitude scale (log/lin) to dBpW.

Key Path	AMPTD Y Scale, Y Axis Unit
<b>Example</b>	UNIT:POW DBPW
Dependencies	Grayed out if an Amplitude Correction with an Antenna Unit is ON.
Readback	dB $\mu$ A
Initial S/W Revision	A.11.00



## Antenna Unit

When a Correction is turned on that uses an Antenna Unit, the Y Axis Unit changes to that Antenna Unit. All of the keys in the Y-Axis Unit menu are then greyed out, except the Antenna Unit key. The unit being used is shown on this key and is shown as selected in the submenu.

Key Path	AMPTD Y Scale, Y Axis Unit
Dependencies	Grayed out if no Amplitude Correction with an Antenna Unit is on.
Readback line	Currently selected unit
Initial S/W Revision	A.11.00

### dB $\mu$ V/m

Sets the amplitude unit for the selected amplitude scale (log/lin) to dB $\mu$ V/m. This is an antenna unit, and this key is grayed out unless a Correction with this Antenna Unit selected is ON. If this is the case, all of the other Antenna Units are grayed out.

Key Path	AMPTD Y Scale, Y Axis Unit, Antenna Unit
<b>Example</b>	UNIT:POW DBUVM
Dependencies	Grayed out if no Amplitude Correction with an Antenna Unit is on.
Readback	dB $\mu$ V/m
Initial S/W Revision	A.02.00

### dB $\mu$ A/m

Sets the amplitude unit for the selected amplitude scale (log/lin) to dB $\mu$ A/m. This is an antenna unit, and this key is grayed out unless a Correction with this Antenna Unit selected is ON. If this is the case, all of the other Antenna Units are grayed out.

Key Path	AMPTD Y Scale, Y Axis Unit, Antenna Unit
<b>Example</b>	UNIT:POW DBUAM
Dependencies	Grayed out if no Amplitude Correction with an Antenna Unit is on.
Readback	dB $\mu$ A/m
Initial S/W Revision	A.02.00

### dB $\mu$ A

Sets the amplitude unit for the selected amplitude scale (log/lin) to dB $\mu$ A. This is an antenna unit, and this key is grayed out unless a Correction with this Antenna Unit selected is ON. If this is the case, all of the other Antenna Units are grayed out.

Key Path	AMPTD Y Scale, Y Axis Unit, Antenna Unit
----------	--

<b>Example</b>	UNIT:POW DBUAM
Dependencies	Grayed out if no Amplitude Correction with an Antenna Unit is on.
Readback	dB $\mu$ A
Initial S/W Revision	A.11.00

### dBpT

Sets the amplitude unit for the selected amplitude scale (log/lin) to dBpT. This is an antenna unit, and this key is grayed out unless a Correction with this Antenna Unit selected is ON. If this is the case, all of the other Antenna Units are grayed out.

Key Path	AMPTD Y Scale, Y Axis Unit, Antenna Unit
<b>Example</b>	UNIT:POW DBPT
Dependencies	Grayed out if no Amplitude Correction with an Antenna Unit is on.
Readback	dBpT
Initial S/W Revision	A.02.00

### dBG

Sets the amplitude unit for the selected amplitude scale (log/lin) to dBG. This is an antenna unit, and this key is grayed out unless a Correction with this Antenna Unit selected is ON. If this is the case, all of the other Antenna Units are grayed out.

Key Path	AMPTD Y Scale, Y Axis Unit, Antenna Unit
<b>Example</b>	UNIT:POW DBG
Dependencies	Grayed out if no Amplitude Correction with an Antenna Unit is on.
Readback	dBG
Initial S/W Revision	A.02.00

### None

This is selected if no Antenna Unit is currently on, however you cannot actually set this value, since it is always grayed out. The key is included simply to provide an indication on the Readback line of the Antenna Unit key when there is no Antenna Unit selected.

Key Path	AMPTD Y Scale, Y Axis Unit, Antenna Unit
Readback	"None"
Initial S/W Revision	A.11.00

## Reference Level Offset

Enables you to add an offset value to the displayed reference level. The reference level is the absolute amplitude represented by the top graticule line on the display.

Key Path	AMPTD Y Scale
Remote Command	:DISPlay:SCHart:VIEW[1]:WINDow[1]:TRACe:Y[:SCALe]:RLEVel:OFFSet <rel_ ampl> :DISPlay:SCHart:VIEW[1]:WINDow[1]:TRACe:Y[:SCALe]:RLEVel:OFFSet?
Example	DISP:SCH:VIEW:WIND:TRAC:Y:RLEV:OFFS 12.7
Preset	0 dB
State Saved	Saved in instrument state
Min	The range for Ref Lvl Offset is variable. It is limited to values that keep the reference level within the range of -327.6 dB to 327.6 dB.
Max	327.6 dB
Initial S/W Revision	A.07.00

## Internal Preamp

Accesses a menu of keys that control the internal preamps. Turning on the preamp gives a better noise figure, but a poorer TOI to noise floor dynamic range. You can optimize this setting for your particular measurement.

The instrument takes the preamp gain into account as it sweeps. If you sweep outside of the range of the preamp the instrument will also account for that. The displayed result will always reflect the correct gain.

For some measurements, when the preamp is on and any part of the displayed frequency range is below the lowest frequency for which the preamp has specifications, a warning condition message appears in the status line. For example, for a preamp with a 9 kHz lowest specified frequency: "Preamp: Accy unspec'd below 9 kHz".

Key Path	AMPTD Y Scale
Scope	Meas Global
Remote Command	[:SENSe]:POWer[:RF]:GAIN[:STATe] OFF ON 0 1 [:SENSe]:POWer[:RF]:GAIN[:STATe]?
Dependencies	Preamp is not available on all hardware platforms. If the preamp is not present or is unlicensed, the key is not shown. The preamp is not available when the electronic/soft attenuator is enabled.
Couplings	The act of connecting the U7227A USB Preamplifier to one of the analyzer's USB ports will cause the Internal Preamp to be switched on. When this happens an informational message will be generated: "Internal Preamp turned on for optimal operation with USB Preamp." Note that if the Internal Preamp was already on, there will be no change to the setting, but if it was Off it will be switched On, to Full Range. Note that this same action occurs when the SA mode is selected while the USB Preamp is

	connected to one of the analyzer's USB ports, if it is the first time that the SA mode has run since powerup, or if the last time the SA mode was running the USB Preamp was NOT connected. Subsequently disconnecting the USB Preamp from USB does not change the Internal Preamp setting nor restore the previous setting.
Preset	OFF
State Saved	Saved in instrument state
Initial S/W Revision	Prior to A.02.00
Modified at S/W Revision	A.14.00

Key Path	AMPTD Y Scale, Internal Preamp
Scope	Meas Global
<b>Remote Command</b>	[ :SENSe ] :POWer [ :RF ] :GAIN:BAND LOW FULL [ :SENSe ] :POWer [ :RF ] :GAIN:BAND?
Dependencies	Preamp is not available on all hardware platforms. If the preamp is not present or is unlicensed, the key is not shown. If a POW:GAIN:BAND FULL command is sent when a low band preamp is available, the preamp band parameter is to LOW instead of FULL, and an "Option not installed" message is generated.
Preset	LOW
State Saved	Saved in instrument state
Initial S/W Revision	Prior to A.02.00

## Off

Turns the internal preamp off

Key Path	AMPTD Y Scale, Internal Preamp
<b>Example</b>	:POW:GAIN OFF
Readback	Off
Initial S/W Revision	Prior to A.02.00

## Low Band

Sets the internal preamp to use only the low band.

The frequency range of the installed (optional) low-band preamp is displayed in square brackets on the Low Band key label.

Key Path	AMPTD Y Scale, Internal Preamp
<b>Example</b>	:POW:GAIN ON

	:POW:GAIN:BAND LOW
Readback	Low Band
Initial S/W Revision	Prior to A.02.00

## Full Range

Sets the internal preamp to use its full range. The low band (0–3.6 GHz or 0–3GHz, depending on the model) is supplied by the low band preamp and the frequencies above low band are supplied by the high band preamp.

The frequency range of the installed (optional) preamp is displayed in square brackets on the Full Range key label. If the high band option is not installed the Full Range key does not appear.

Key Path	AMPTD Y Scale, Internal Preamp
<b>Example</b>	:POW:GAIN ON :POW:GAIN:BAND FULL
Readback	Full Range
Initial S/W Revision	Prior to A.02.00

## Auto Couple

The Auto Couple feature provides a quick and convenient way to automatically couple multiple instrument settings. This helps ensure accurate measurements and optimum dynamic range. When the Auto Couple feature is activated, either from the front panel or remotely, all parameters of the current measurement that have an Auto/Manual mode are set to Auto mode and all measurement settings dependent on (or coupled to) the Auto/Man parameters are automatically adjusted for optimal performance.

However, the Auto Couple key actions are confined to the current measurement only. It does not affect other measurements in the mode, and it does not affect markers, marker functions, or trace or display attributes.

See ["More Information" on page 622](#)

<b>Key Path</b>	Front-panel key
<b>Remote Command</b>	:COUPLe ALL NONE
<b>Example</b>	:COUP ALL
<b>Notes</b>	:COUPLe ALL puts all Auto/Man parameters in Auto mode (equivalent to pressing the Auto Couple key). :COUPLE NONE puts all Auto/Man parameters in manual mode. It decouples all the coupled instrument parameters and is not recommended for making measurements.
<b>Initial S/W Revision</b>	Prior to A.02.00

### More Information

There are two types of functions that have Auto/Manual modes.

#### Auto/Man Active Function keys

An Auto/Man toggle key controls the binary state associated with an instrument parameter by toggling between Auto (where the parameter is automatically coupled to the other parameters it is dependent upon) and Man (where the parameter is controlled independent of the other parameters), as well as making the parameter the active function. The current mode is indicated on the softkey with either Auto or Man underlined as illustrated below.



#### Auto/Man 1-of-N keys

An Auto/Man 1-of-N key allows you to manually pick from a list of parameter values, or place the function in Auto, in which case the value is automatically selected (and indicated) as shown below. If in Auto, Auto is underlined on the calling key. If in manual operation, manual is indicated on the calling key. But the calling key does not actually toggle the function, it simply opens the menu.

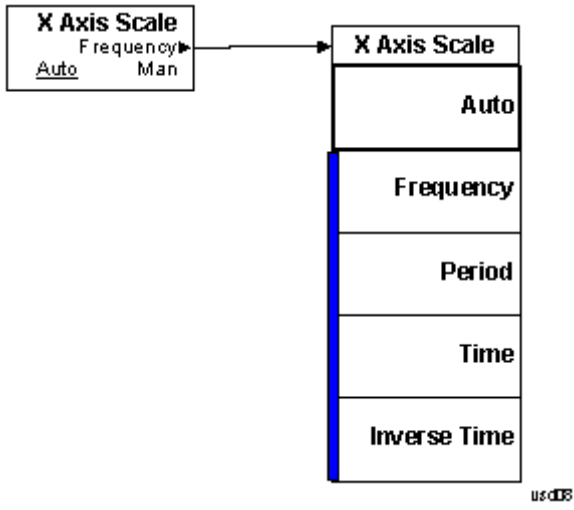

## BW

Displays the menu key that enables you to control the resolution BW.

Key Path	Front-panel key
Notes	Front panel only.
Initial S/W Revision	A.07.00

## Res BW

Activates the Resolution Bandwidth (RBW) action function, which allows you to manually set the RBW.

Key Path	BW								
<b>Remote Command</b>	<pre>[ :SENSe]:BANDwidth BWIDth[:RESolution] &lt;freq&gt; [:SENSe]:BANDwidth BWIDth[:RESolution]? [:SENSe]:BANDwidth BWIDth[:RESolution]:AUTO OFF ON 0 1 [:SENSe]:BANDwidth BWIDth[:RESolution]:AUTO?</pre>								
<b>Example</b>	<pre>BAND 200kHz BAND? FSC:BAND:AUTO 0 FSC:BAND:AUTO?</pre>								
Notes	<p>For Frequency Scan measurements, this key only affects RBWs used for meters.</p> <p>For numeric entries, the RBW chooses the nearest (arithmetically, on a linear scale, rounding up) available RBW to the value entered.</p> <p>The suffix 1 2 is irrelevant to the measurement, they are added solely for remote language compatibility.</p>								
Dependencies	<p>When in zero span and EMC Std is set to None, there is no Auto setting for the Res BW. The Auto/Man line on the Res BW softkey disappears in this case, and if the SCPI command [:SENSe]:BWID[:RESolution]:AUTO ON is sent, it generates an error.</p>								
Couplings	<p>When a CISPR or MIL EMI Standard is in use, the Res BW is coupled to the Center Frequency and not to the Span.</p> <p>When in the CISPR or MIL EMC Standard, selecting Auto will make RBW auto coupled to Center Frequency, in order to comply with EMI specs.</p> <p>When EMC Standard= CISPR,</p> <table border="1" style="width: 100%; border-collapse: collapse;"> <tr> <td style="width: 50%;"><math>&lt;150\text{ kHz}</math></td> <td style="width: 50%; text-align: right;">200 Hz</td> </tr> <tr> <td><math>150\text{ kHz to } &lt;30\text{ MHz}</math></td> <td style="text-align: right;">9 kHz</td> </tr> <tr> <td><math>\geq 30\text{ MHz to } &lt;1\text{ GHz}</math></td> <td style="text-align: right;">120 kHz</td> </tr> <tr> <td><math>\geq 1\text{ GHz}</math></td> <td style="text-align: right;">1 MHz</td> </tr> </table> <p>When EMC Standard= MIL,</p>	$<150\text{ kHz}$	200 Hz	$150\text{ kHz to } <30\text{ MHz}$	9 kHz	$\geq 30\text{ MHz to } <1\text{ GHz}$	120 kHz	$\geq 1\text{ GHz}$	1 MHz
$<150\text{ kHz}$	200 Hz								
$150\text{ kHz to } <30\text{ MHz}$	9 kHz								
$\geq 30\text{ MHz to } <1\text{ GHz}$	120 kHz								
$\geq 1\text{ GHz}$	1 MHz								



	< 1 kHz	10 Hz
	1 kHz to < 10 kHz	100 Hz
	10 kHz to < 150 kHz	1 kHz
	150 kHz to <30 MHz	10 kHz
	30 MHz to <1 GHz	100 kHz
	≥1 GHz	1 MHz
Preset	120 kHz ON	
State Saved	Saved in instrument state	
Min	1 Hz	
Max	8 MHz is the max equivalent -3 dB RBW, which means that the named RBW (the one shown on the key ) can actually exceed 8 MHz if using a filter type other than -3dB.	
Default Unit	Hz	
<b>Backwards Compatibility SCPI</b>	:SENSe1 SENSe2  [SENSe]:BANDwidth BWIDth[:RESolution]	
Backwards Compatibility SCPI Notes	This command above is included for ESU compatibility. The suffix 1 2 is irrelevant to the measurement, they are added solely for remote language compatibility.	
Initial S/W Revision	A.07.00	

## Filter BW

Allows you to choose the filter based on its -3 dB (Normal) bandwidth, its -6 dB bandwidth, its Noise bandwidth, or its Impulse bandwidth.

Key Path	BW
<b>Remote Command</b>	[ :SENSe: ] :BANDwidth BWIDth[:RESolution]:TYPE DB3   DB6   IMPulse   NOISe  [ :SENSe: ] :BANDwidth BWIDth[:RESolution]:TYPE?
<b>Example</b>	BAND:TYPE DB6 BAND:TYPE?
Notes	When NOISe is sent, the Filter BW will only be changed when the EMC Standard is set to None. The Filter BW will be set to Noise when the IDN Model = System IDN Response. For other IDN Models, the Filter BW will be set to DB3. This is for ESU Backwards Compatibility.
Dependencies	DB3 DB6 IMPulse are not available when the EMC Standard is set to CISPR or MIL. See error - 221.1100 in Master Error Messages: X-Series document for exact error text.
Preset	Preset type is based on EMC Standard Preset To key.
State Saved	Saved in instrument state.
Range	DB3 DB6 IMPulse NOISe

Readback Text	The currently selected Filter BW
<b>Backwards Compatibility SCPI</b>	SENSe1   SENSe2   [SENSe] :BANDwidth BWIDth[:RESolution]
Backwards Compatibility SCPI Notes	This command above is included for ESU compatibility. The suffix 1 2 is irrelevant to the measurement; they are added solely for remote language compatibility.
Initial S/W Revision	A.10.00
<b>Remote Command</b>	:SENSe1   SENSe2   [SENSe] :BANDwidth BWIDth[:RESolution]:TYPE NORMal   PULSe  :SENSe1   SENSe2   [SENSe] :BANDwidth BWIDth[:RESolution]:TYPE?
<b>Example</b>	BAND:TYPE PULS BAND:TYPE?
Notes	This command is included for ESU compatibility. The suffix [1]2 is irrelevant to the measurement, they are added solely for the compatibility purpose. "NORMal" is alias to Filter BW "3dB" when the EMC Standard is set to None. Or else, sending this command will not change the Filter BW. "PULSe" is alias to Filter BW "6dB" when the EMC Standard is set to None. Or else, sending this command will not change the Filter BW.
Range	NORMal PULSe

## Cont (Continuous Measurement/Sweep)

Sets the analyzer for Continuous measurement operation. The single/continuous state is Meas Global so the setting will affect all measurements. If you are Paused, pressing Cont does a Resume.

Key Path	Front-panel key
Remote Command	:INITiate:CONTinuous OFF ON 0 1 :INITiate:CONTinuous?
Example	:INIT:CONT 0 puts analyzer in Single measurement operation. :INIT:CONT 1 puts analyzer in Continuous measurement operation
Preset	ON (Note that SYST:PRESet sets INIT:CONT to ON but *RST sets INIT:CONT to OFF)
State Saved	Saved in instrument state
Backwards Compatibility Notes	For Spectrum Analysis mode in ESA and PSA, there is no Cont hardkey, instead there is a Sweep Single/Cont key. In these analyzers, switching the Sweep Single/Cont key from Single to Cont restarts averages (displayed average count reset to 1), but does not restart Max Hold and Min Hold. The X-Series has Single and Cont keys in place of the SweepSingleCont key. In the X-Series, if in single measurement, the Cont key (and INIT:CONT ON ) switches to continuous measurement, but never restarts a measurement and never resets a sweep.
Initial S/W Revision	Prior to A.02.00

In Swept SA Measurement (Spectrum Analysis Mode):

The analyzer takes repetitive sweeps, averages, measurements, etc., when in Continuous mode. When the average count reaches the Average/Hold Number the count stops incrementing, but the analyzer keeps sweeping. See the Trace/Detector section for the averaging formula used both before and after the Average/Hold Number is reached. The trigger condition must be met prior to each sweep. The type of trace processing for multiple sweeps, is set under the Trace/Detector key, with choices of Trace Average, Max Hold, or Min Hold.

In Other Measurements/Modes:

With Avg/Hold Num (in the Meas Setup menu) set to Off or set to On with a value of 1, a sweep is taken after the trigger condition is met; and the analyzer continues to take new sweeps after the current sweep has completed and the trigger condition is again met. However, with Avg/Hold Num set to On with a value >1, multiple sweeps (data acquisitions) are taken for the measurement. The trigger condition must be met prior to each sweep. The sweep is not stopped when the average count k equals the number N set for Avg/Hold Num is reached, but the number k stops incrementing. A measurement average usually applies to all traces, marker results, and numeric results. But sometimes it only applies to the numeric results.

If the analyzer is in Single measurement, pressing the Cont key does not change k and does not cause the sweep to be reset; the only action is to put the analyzer into Continuous measurement operation.

If it is already in continuous sweep:

the INIT:CONT 1 command has no effect

9 Strip Chart Measurement  
Cont (Continuous Measurement/Sweep)

the INIT:CONT 0 command will place the analyzer in Single Sweep but will have no effect on the current sequence until  $k = N$ , at which point the current sequence will stop and the instrument will go to the idle state.

File

See "File" on page 266

## FREQ Channel

Displays the menu keys that enable you to control the frequency parameters and scale type.

Key Path	Front-panel key
Notes	Front panel only.
Initial S/W Revision	A.07.00

### Frequency

Sets the frequency of Meters in the Frequency Scan measurement. For the Strip Chart measurement, this key will set the frequency for both meters and strip chart. For APD measurement, this key is used to set the frequency to perform Amplitude Probability Distribution. For Monitor Spectrum measurement, this key is used to set the Center Frequency.

Key Path	FREQ Channel
<b>Remote Command</b>	<code>[ :SENSe ] :FREQuency:CENTer &lt;frequency&gt;</code> <code>[ :SENSe ] :FREQuency:CENTer ?</code>
<b>Example</b>	FREQ:CENT 3 GHZ FREQ:CENT?
Notes	For the Frequency Scan measurement, when QPD, EMI Average or RMS Average detectors is selected, you will see some delay for meters to reflect the new data due to filtering time. However, if the change in the meters frequency is performed by knob or step keys, there will be no filtering time added unless the change of the meters frequency has triggered other parameter changes.
Preset	515 MHz
State Saved	Saved in instrument state.
Min	For Frequency Scan and Strip Chart measurements, it depends on the instrument minimum frequency.
Max	For Frequency Scan, and Strip Chart measurements, it depends on the instrument maximum frequency.
Default Unit	Hz
Status Bits/OPC dependencies	non-overlapped
<b>Backwards Compatibility SCPI</b>	<code>:SENSe1   SENSe2   [SENSe] :FREQuency:CENTer</code> <code>:SENSe1   SENSe2   [SENSe] :FREQuency:FIXed</code>
Backwards Compatibility SCPI Notes	These commands above are included for ESU compatibility. The suffix 1 2 is irrelevant to the measurement, they are added solely for remote language compatibility.
Initial S/W Revision	A.07.00

## Freq/ Step

Changes the step size for the Frequency.

Key Path	FREQ Channel
<b>Remote Command</b>	<pre>[ :SENSe]:FREQuency:CENTer:STEP[:INCRement] &lt;freq&gt; [ :SENSe]:FREQuency:CENTer:STEP[:INCRement]? [ :SENSe]:FREQuency:CENTer:STEP:AUTO OFF ON 0 1 [ :SENSe]:FREQuency:CENTer:STEP:AUTO?</pre>
<b>Example</b>	<pre>FREQ:CENT:STEP:AUTO ON FREQ:CENT:STEP 500 MHz FREQ:CENT UP increases the current center frequency value by 500 MHz FREQ:CENT:STEP? FREQ:CENT:STEP:AUTO?</pre>
Notes	Preset and Max values are dependent on Hardware Options (503, 508, 513, 526)
Preset	Auto ON
State Saved	Saved in instrument state
Min	- ( the maximum frequency of the instrument). (that is, a 27 GHz max freq instrument has a CF step range of +/- 27 GHz)
Max	The maximum frequency of the instrument. (that is, a 27 GHz max freq instrument has a CF step range of +/- 27 GHz)
Default Unit	Hz
Status Bits/OPC dependencies	non-overlapped
Initial S/W Revision	A.07.00

9 Strip Chart Measurement  
Input/Output

Input/Output

See "[Input/Output](#)" on page 150



## Marker

Accesses the Marker menu. The functions in this menu include a 1-of-N selection of the control mode Normal, Delta or Off for the selected marker. If the selected marker is Off, pressing Marker sets it to Normal and places it at the center of the screen on the trace determined by the Marker Trace rules. At the same time, the reference value of the selected marker appears on the Active Function area.

The marker X axis value entered in the active function area will display the marker value to its full entered precision.

Key Path	Front-panel key
Remote Command	:CALCulate:SCHart:MARKer[1] 2 ...12:MODE Position DELTA OFF :CALCulate:SCHart:MARKer[1] 2 ...12:MODE?
Example	CALC:SCH:MARK:MODE OFF CALC:SCH:MARK:MODE?
Notes	If the selected marker is Off, pressing Marker sets it to Normal and places it at the center of the screen on the trace determined by the Marker Trace rules. At the same time, Marker X Axis Value appears in the Active Function area.  Default Active Function: the active function for the selected marker's current control mode. Note that if the current control mode is Off, there is no active function and the active function is turned off.  Active Function Display: the marker X axis value entered in the active function area will display the marker value to its fully entered precision.
Preset	OFF
State Saved	Saved in instrument state
Initial S/W Revision	A.07.00

### Select Marker

Display a menu with 12 markers available for selection for the current measurement.

Key Path	Marker
Notes	Front panel only. The selected marker is remembered even when not in the Marker menu and is used
Preset	Marker 1
State Saved	Saved in instrument state.
Initial S/W Revision	A.07.00

### Marker X Axis Value (Remote Command Only)

Sets the marker X Axis value in the current marker X Axis Scale unit. It has no effect if the control mode is Off, but is the SCPI equivalent of entering an X value, if the control mode is Normal or Delta.

<b>Key Path</b>	Marker, Select Marker
<b>Remote Command</b>	:CALCulate:SCHart:MARKer[1] 2 ...12:X <real> :CALCulate:SCHart:MARKer[1] 2 ...12:X?
<b>Example</b>	CALC:SCH:MARK3:X 0 CALC:SCH:MARK3:X?
<b>Notes</b>	If no suffix is sent, it will use the fundamental units for the current marker X Axis Scale. If a suffix is sent that does not match the current marker X Axis Scale unit, an "Invalid suffix" error will be generated.  The query returns the marker's absolute X Axis value if the control mode is Normal, or the offset from the marker's reference marker, if the control mode is Delta. The query is returned in the fundamental units for the current marker X Axis scale: seconds. If the marker is off the response is not a number (NAN).
<b>Preset</b>	0
<b>State Saved</b>	No
<b>Min</b>	-9.9E+37
<b>Max</b>	9.9E+37
<b>Initial S/W Revision</b>	A.07.00

### Marker Y Axis Value ( Remote Command Only )

Returns the marker Y Axis value in the current marker Y Axis unit.

<b>Remote Command</b>	:CALCulate:SCHart:MARKer[1] 2 ...12:Y?
<b>Example</b>	CALC:SCH:MARK11:Y 0 CALC:SCH:MARK11:Y?
<b>Notes</b>	The query returns the marker Y-axis result. If the marker is Off the response is not a number (NAN).
<b>State Saved</b>	No
<b>Initial S/W Revision</b>	A.07.00

### Normal

Sets the control mode for the selected marker to Normal and turns on the active function for setting its value. If the selected marker was off, it is placed at the center of the screen on the trace specified by the marker's Trace attribute.

A Normal mode (POSition type) marker can be moved to any point on the X Axis by specifying its X Axis value. Its absolute Y Axis value is then the value of the trace point at that X Axis value.

Key Path	Marker
<b>Example</b>	CALC:SCH:MARK:MODE POS Sets Marker 1 to Normal.
Couplings	The marker addressed by this command becomes the selected marker on the front panel.
State Saved	Saved in instrument state.
Initial S/W Revision	A.07.00

## Delta

Sets the control mode for the selected marker to Delta and turns on the active function for setting its delta value. If the selected marker is off, the marker is placed at the center of the screen on the trace specified by the marker's Trace attribute.

In Delta mode the marker result shows the relative result between the selected (Delta) marker and its reference marker. A delta marker can be moved to any point on the X Axis by specifying its X Axis offset from a reference marker. Its absolute Y Axis value is then the value of the trace point at that X Axis value.

Key Path	Marker
<b>Example</b>	CALC:SCH:MARK:MODE DELT Sets marker 1 to Delta.
Dependencies	The marker addressed by this command becomes the selected marker on the front panel.
State Saved	Saved in instrument state.
Initial S/W Revision	A.07.00

## Off

Turn off the selected marker. Remove marker annunciation from the display. Turn off any active function. Tuning the marker off does not affect which marker is selected.

Key Path	Marker
<b>Example</b>	CALC:SCH:MARK:MODE OFF Sets Marker 1 to Off.
State Saved	Saved in instrument state
Initial S/W Revision	A.07.00

## Marker X Axis Value (Remote Command Only)

Sets the marker X Axis value in the current marker X Axis Scale unit. It has no effect if the control mode is Off, but is the SCPI equivalent of entering an X value, if the control mode is Normal or Delta.

<b>Key Path</b>	Marker, Select Marker
<b>Remote Command</b>	:CALCulate:SCHart:MARKer[1] 2 ...12:X <real> :CALCulate:SCHart:MARKer[1] 2 ...12:X?
<b>Example</b>	CALC:SCH:MARK3:X 0 CALC:SCH:MARK3:X?
<b>Notes</b>	If no suffix is sent, it will use the fundamental units for the current marker X Axis Scale. If a suffix is sent that does not match the current marker X Axis Scale unit, an "Invalid suffix" error will be generated. The query returns the marker's absolute X Axis value if the control mode is Normal, or the offset from the marker's reference marker, if the control mode is Delta. The query is returned in the fundamental units for the current marker X Axis scale: seconds. If the marker is off the response is not a number (NAN).
<b>Preset</b>	0
<b>State Saved</b>	No
<b>Min</b>	-9.9E+37
<b>Max</b>	9.9E+37
<b>Initial S/W Revision</b>	A.07.00

### Marker Y Axis Value ( Remote Command Only )

Returns the marker Y Axis value in the current marker Y Axis unit.

<b>Remote Command</b>	:CALCulate:SCHart:MARKer[1] 2 ...12:Y?
<b>Example</b>	CALC:SCH:MARK11:Y 0 CALC:SCH:MARK11:Y?
<b>Notes</b>	The query returns the marker Y-axis result. If the marker is Off the response is not a number (NAN).
<b>State Saved</b>	No
<b>Initial S/W Revision</b>	A.07.00

### Properties

Accesses a menu that allows you to set marker properties and to access the marker trace menu.

<b>Key Path</b>	Marker
<b>Initial S/W Revision</b>	A.07.00

## Select Marker

Display a menu with 12 markers available for selection for the current measurement.

Key Path	Marker
Notes	Front panel only. The selected marker is remembered even when not in the Marker menu and is used
Preset	Marker 1
State Saved	The number of the selected marker is saved in instrument state.
Initial S/W Revision	A.07.00

## Relative To

Select the reference marker for a marker in Delta mode.

Key Path	Marker, Properties
<b>Remote Command</b>	:CALCulate:Schart:MARKer[1] 2 ...12:REFerence <integer> :CALCulate:Schart:MARKer[1] 2 ...12:REFerence?
<b>Example</b>	CALC:SCH:MARK5:REF 1 CALC:SCH:MARK5:REF?
Notes	A marker cannot be relative to itself so that choice is grayed out, and if sent from SCPI, generates error -221: "Settings conflict; marker cannot be relative to itself." When queried, a single value will be returned - the specified marker number's relative marker.
Preset	2
State Saved	Saved in instrument state
Min	1
Max	12
Initial S/W Revision	A.07.00

## Marker Trace

Assign the specified marker to the designated trace.

Key Path	Marker, Properties
<b>Remote Command</b>	:CALCulate:Schart:MARKer[1] 2 ...12:TRACe 1 2 3 :CALCulate:Schart:MARKer[1] 2 ...12:TRACe?
<b>Example</b>	CALC:SCH:MARK1:TRAC 2 places marker 1 on trace 2.

Notes	A marker may be placed on a blanked and/or inactive trace, even though the trace is not visible and/or updating. An application may register a trace name to be displayed on the key instead of a trace number.
Couplings	The state of Marker Trace is not affected by the Auto Couple key. If a Marker Trace is chosen manually, Auto Init goes to Off for that marker. Sending the remote command causes the addressed marker to become selected.
Preset	1
State Saved	The Marker Trace and state of Auto Init for each marker is saved in instrument state.
Min	1
Max	3
Readback line	Trace N where N is the trace number to which the marker is currently assigned.
Initial S/W Revision	A.07.00

## Couple Marker

When this function is invoked, moving any marker causes an “equal X Axis movement” of every other marker which is active. By “equal X Axis movement” we mean that the difference between each marker’s X Axis value (in the fundamental x-axis units of the trace that marker is on) is preserved, as is the X Axis value of the marker being moved (in the same fundamental X-axis units).

**NOTE** This may result in markers going off screen.

Key Path	Marker
Remote Command	:CALCulate:SCHart:MARKer:COUPle[:STATe] ON OFF 1 0 :CALCulate:SCHart:MARKer:COUPle[:STATe]?
Example	CALC:SCH:MARK:COUP ON CALC:SCH:MARK:COUP?
Preset	OFF
State Saved	Saved in instrument state
Initial S/W Revision	A.07.00

## All Marker Off

Turns all markers Off.

Key Path	Marker
Remote Command	:CALCulate:SCHart:MARKer:AOff

---

<b>Example</b>	:CALC:SCH:MARK:AOFF
Couplings	Sets the selected marker to 1.
Initial S/W Revision	A.07.00

---

## Marker Function

Accesses a menu keys that allows you to do marker zoom related function.

Key Path	Front-panel key
Notes	Front panel only.
Initial S/W Revision	A.07.00

## Marker Zoom

The window will display the strip chart at current selected marker at the center of strip chart with the span of 10% of the previous span of strip chart.

Key Path	Marker Function
<b>Remote Command</b>	CALCulate:SCHart:MARKer[1] 2 ...12:FUNCTION:ZOOM
<b>Example</b>	CALC:SCH:MARK1:FUNC:ZOOM
Dependencies	Marker Zoom function is not available when the new span of strip chart is less than the Min of value x-scale/div
Initial S/W Revision	A.07.00

## Marker Zoom Out

Marker Zoom Out will display the strip chart with previous span of strip chart.

Key Path	Marker Function
<b>Remote Command</b>	CALCulate:SCHart:MARKer[1] 2 ...12:FUNCTION:ZOOM:OUT
<b>Example</b>	CALC:SCH:MARK1:FUNC:ZOOM:OUT
Dependencies	Marker Zoom Out key is not available if Marker Zoom didn't executed before
<b>Backwards Compatibility SCPI</b>	CALCulate:SCHart:MARKer[1] 2 ...12:FUNCTION:PREVIOUS:ZOOM
Initial S/W Revision	A.07.00

## Marker Zoom Out Full

Marker Zoom Out Full will display the strip chart with the span of strip chart that existed before a Marker Zoom was performed.



Key Path	Marker Function
<b>Remote Command</b>	CALCulate:SCHart:MARKer[1] 2 ...12:FUNction:ZOOM:CLEar
<b>Example</b>	CALC:SCH:MARK1:FUNC:ZOOM:CLE
Notes	You must be in the mode that includes Strip Chart measurement to use this command. Use INSTRument:SElect to set the mode.
Dependencies	Marker Zoom Out Full key is not available if Marker Zoom was not executed previously.
Initial S/W Revision	A.07.00

## Marker To

Displays a menu that enables you to access the Marker To function.

Key Path	Front-panel key
Notes	Front panel only.
Initial S/W Revision	A.07.00

## Mkr $\Delta$ -> Span

Sets the display range to the values of the delta markers.

Key Path	Marker ->
<b>Remote Command</b>	:CALCulate:SCHart:MARKer[1] 2 ...12[:SET]:DELta:SPAN
<b>Example</b>	CALC:SCH:MARK2:DELT:SPAN
Dependencies	This function is only available when the selected marker is a delta marker. Otherwise the key is grayed out.
Initial S/W Revision	A.07.00

## Meas

The information in this section is common to all measurements. For key and remote command information for a specific measurement, refer to the section that describes the measurement of interest.

Measurements available under the Meas key are specific to the current Mode.

When viewing Help for measurements, note the following:

**NOTE**

Operation for some keys differs between measurements. The information displayed in Help pertains to the current measurement. To see how a key operates in a different measurement, exit Help (press the Cancel Esc key), select the measurement, then reenter Help (press the Help key) and press that key.

---

Key Path	Front-panel key
Initial S/W Revision	Prior to A.02.00

---

### Remote Measurement Functions

This section contains the following topics:

"Measurement Group of Commands" on page 1048

"Current Measurement Query (Remote Command Only)" on page 1050

"Limit Test Current Results (Remote Command Only)" on page 1050

"Data Query (Remote Command Only)" on page 1050

"Calculate/Compress Trace Data Query (Remote Command Only)" on page 1051

"Calculate Peaks of Trace Data (Remote Command Only)" on page 1056

Hardware-Accelerated Fast Power Measurement (Remote Command Only)

"Format Data: Numeric Data (Remote Command Only)" on page 1057

"Format Data: Byte Order (Remote Command Only)" on page 1058

---

Initial S/W Revision	Prior to A.02.00
----------------------	------------------

---

## Measurement Group of Commands

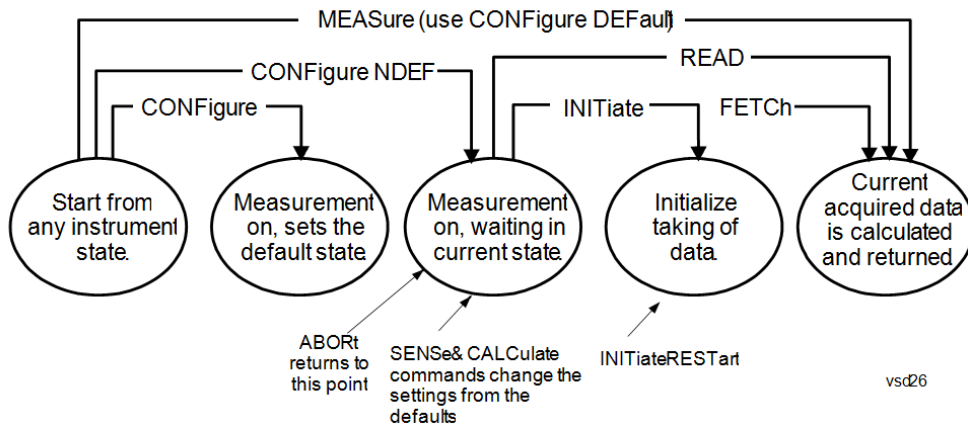

---

### Measure Commands:

:MEASure:<measurement>[n]?

This is a fast single-command way to make a measurement using the factory default instrument settings. These are the settings and units that conform to the Mode Setup settings (e.g. radio standard) that you have currently selected.

- Stops the current measurement (if any) and sets up the instrument for the specified measurement using the factory defaults
- Initiates the data acquisition for the measurement
- Blocks other SCPI communication, waiting until the measurement is complete before returning results.
- If the function does averaging, it is turned on and the number of averages is set to 10.
- After the data is valid it returns the scalar results, or the trace data, for the specified measurement. The type of data returned may be defined by an [n] value that is sent with the command.
- The scalar measurement results will be returned if the optional [n] value is not included, or is set to 1. If the [n] value is set to a value other than 1, the selected trace data results will be returned. See each command for details of what types of scalar results or trace data results are available.
- ASCII is the default format for the data output. (Older versions of Spectrum Analysis and Phase Noise mode measurements only use ASCII.) The binary data formats should be used for handling large blocks of data since they are smaller and faster than the ASCII format. Refer to the FORMat:DATA command for more information.

If you need to change some of the measurement parameters from the factory default settings you can set up the measurement with the CONFIgure command. Use the commands in the SENSe:<measurement> and CALCulate:<measurement> subsystems to change the settings. Then you can use the READ? command to initiate the measurement and query the results.

If you need to repeatedly make a given measurement with settings other than the factory defaults, you can use the commands in the SENSe:<measurement> and CALCulate:<measurement> subsystems to set up the measurement. Then use the READ? command to initiate the measurement and query results.

Measurement settings persist if you initiate a different measurement and then return to a previous one. Use READ:<measurement>? if you want to use those persistent settings. If you want to go back to the default settings, use MEASure:<measurement>?.

---

### Configure Commands:

:CONFIgure:<measurement>

This command stops the current measurement (if any) and sets up the instrument for the specified measurement using

---

---

the factory default instrument settings. It does not initiate the taking of measurement data unless INIT:CONTInuous is ON. If you change any measurement settings after using the CONFigure command, the READ command can be used to initiate a measurement without changing the settings back to their defaults.

In the Swept SA measurement in Spectrum Analyzer mode the CONFigure command also turns the averaging function on and sets the number of averages to 10 for all measurements.

:CONFigure: <measurement>: NDEFault stops the current measurement and changes to the specified measurement. It does not change the settings to the defaults. It does not initiate the taking of measurement data unless INIT:CONTInuous is ON.

The CONFigure? query returns the current measurement name.

The CONFigure:CATalog? query returns a quoted string of all licensed measurement names in the current mode. For example, "SAN, CHP, OBW, ACP, PST, TXP, SPUR, SEM, LIST".

---

#### Fetch Commands:

:FETCh:<measurement>[n]?

This command puts selected data from the most recent measurement into the output buffer. Use FETCh if you have already made a good measurement and you want to return several types of data (different [n] values, for example, both scalars and trace data) from a single measurement. FETCh saves you the time of re-making the measurement. You can only FETCh results from the measurement that is currently active, it will not change to a different measurement. An error message is reported if a measurement other than the current one is specified.

If you need to get new measurement data, use the READ command, which is equivalent to an INITiate followed by a FETCh.

The scalar measurement results will be returned if the optional [n] value is not included, or is set to 1. If the [n] value is set to a value other than 1, the selected trace data results will be returned. See each command for details of what types of scalar results or trace data results are available. The binary data formats should be used for handling large blocks of data since they are smaller and transfer faster than the ASCII format. (FORMat:DATA)

FETCh may be used to return results other than those specified with the original READ or MEASure command that you sent.

---

#### INITiate Commands:

:INITiate:<measurement>

This command is not available for measurements in all the instrument modes:

- Initiates a trigger cycle for the specified measurement, but does not output any data. You must then use the FETCh<meas> command to return data. If a measurement other than the current one is specified, the instrument will switch to that measurement and then initiate it.
- For example, suppose you have previously initiated the ACP measurement, but now you are running the channel power measurement. If you send INIT:ACP? it will change from channel power to ACP and will initiate an ACP measurement.
- Does not change any of the measurement settings. For example, if you have previously started the ACP measurement and you send INIT:ACP? it will initiate a new ACP measurement using the same instrument settings as the last time ACP was run.
- If your selected measurement is currently active (in the idle state) it triggers the measurement, assuming the trigger conditions are met. Then it completes one trigger cycle. Depending upon the measurement and the number of averages, there may be multiple data acquisitions, with multiple trigger events, for one full trigger cycle. It also holds off additional commands on GPIB until the acquisition is complete.

---

#### READ Commands:

:READ:<measurement>[n]?

- Does not preset the measurement to the factory default settings. For example, if you have previously initiated the ACP
-

---

measurement and you send READ:ACP? it will initiate a new measurement using the same instrument settings.

- Initiates the measurement and puts valid data into the output buffer. If a measurement other than the current one is specified, the instrument will switch to that measurement before it initiates the measurement and returns results.
  - For example, suppose you have previously initiated the ACP measurement, but now you are running the channel power measurement. Then you send READ:ACP? It will change from channel power back to ACP and, using the previous ACP settings, will initiate the measurement and return results.
  - Blocks other SCPI communication, waiting until the measurement is complete before returning the results
  - If the optional [n] value is not included, or is set to 1, the scalar measurement results will be returned. If the [n] value is set to a value other than 1, the selected trace data results will be returned. See each command for details of what types of scalar results or trace data results are available. The binary data formats should be used when handling large blocks of data since they are smaller and faster than the ASCII format. (FORMat:DATA)
- 

---

Initial S/W Revision	Prior to A.02.00
----------------------	------------------

---

### Current Measurement Query (Remote Command Only)

This command returns the name of the measurement that is currently running.

---

<b>Remote Command</b>	:CONFigure?
-----------------------	-------------

---

<b>Example</b>	CONF?
----------------	-------

---

Initial S/W Revision	Prior to A.02.00
----------------------	------------------

---

### Limit Test Current Results (Remote Command Only)

Queries the status of the current measurement limit testing. It returns a 0 if the measured results pass when compared with the current limits. It returns a 1 if the measured results fail any limit tests.

---

<b>Remote Command</b>	:CALCulate:CLIMits:FAIL?
-----------------------	--------------------------

---

<b>Example</b>	CALC:CLIM:FAIL? queries the current measurement to see if it fails the defined limits. Returns a 0 or 1: 0 it passes, 1 it fails.
----------------	--

---

Initial S/W Revision	Prior to A.02.00
----------------------	------------------

---

### Data Query (Remote Command Only)

Returns the designated measurement data for the currently selected measurement and subopcode.

n = any valid subopcode for the current measurement. See the measurement command results table for your current measurement, for information about what data is returned for the subopcodes.

This command uses the data setting specified by the FORMat:BORDER and FORMat:DATA commands and can return real or ASCII data. (See the format command descriptions under Input/Output in the Analyzer Setup section.)

<b>Remote Command</b>	:CALCulate:DATA[n]?
<b>Notes</b>	The return trace depends on the measurement. In CALCulate:<meas>:DATA[n], n is any valid subopcode for the current measurement. It returns the same data as the FETCH:<measurement>? query where <measurement> is the current measurement.
<b>Initial S/W Revision</b>	Prior to A.02.00

### Calculate/Compress Trace Data Query (Remote Command Only)

Returns compressed data for the currently selected measurement and sub-opcode [n].

n = any valid sub-opcode for that measurement. See the MEASure:<measurement>? command description of your specific measurement for information on the data that can be returned.

The data is returned in the current Y Axis Unit of the analyzer. The command is used with a sub-opcode <n> (default=1) to specify the trace. With trace queries, it is best if the analyzer is not sweeping during the query. Therefore, it is generally advisable to be in Single Sweep, or Update=Off.

This command is used to compress or decimate a long trace to extract and return only the desired data. A typical example would be to acquire N frames of GSM data and return the mean power of the first burst in each frame. The command can also be used to identify the best curve fit for the data.

<b>Remote Command</b>	:CALCulate:DATA<n>:COMPRESS? BLOCK   CFIT   MAXimum   MINimum   MEAN   DMEan   RMS   RMSCubed   SAMPLE   SDEVIation   PPHase [,<soffset> [,<length>[,<roffset>[,<rlimit>]]]]
<b>Example</b>	To query the mean power of a set of GSM bursts: Supply a signal that is a set of GSM bursts. Select the IQ Waveform measurement (in IQ Analyzer Mode). Set the sweep time to acquire at least one burst. Set the triggers such that acquisition happens at a known position relative to a burst. Then query the mean burst levels using, CALC:DATA2:COMP? MEAN, 24e-6, 526e-6 (These parameter values correspond to GSM signals, where 526e-6 is the length of the burst in the slot and you just want 1 burst.)
<b>Notes</b>	The command supports 5 parameters. Note that the last 4 (<soffset>, <length>, <roffset>, <rlimit>) are optional. But these optional parameters must be entered in the specified order. For example, if you want to specify <length>, then you must also specify <soffset>. See details below for a definition of each of these parameters. This command uses the data in the format specified by FORMat:DATA, returning either binary or ASCII data.
<b>Initial S/W Revision</b>	Prior to A.02.00

- BLOCK or block data - returns all the data points from the region of the trace data that you specify. For example, it could be used to return the data points of an input signal over several timeslots, excluding the portions of the trace data that you do not want. (This is x,y pairs for trace data and I,Q pairs for complex data.)

- CFIT or curve fit - applies curve fitting routines to the data. <soffset> and <length> are required to define the data that you want. <roffset> is an optional parameter for the desired order of the curve equation. The query will return the following values: the x-offset (in seconds) and the curve coefficients ((order + 1) values).

MIN, MAX, MEAN, DME, RMS, RMSC, SAMP, SDEV and PPH return one data value for each specified region (or <length>) of trace data, for as many regions as possible until you run out of trace data (using <roffset> to specify regions). Or they return the number of regions you specify (using <rlimit>) ignoring any data beyond that.

- MINimum - returns the minimum data point (y value) for the specified region(s) of trace data. For I/Q trace data, the minimum magnitude of the I/Q pairs is returned.
- MAXimum - returns the maximum data point (y value) for the specified region(s) of trace data. For I/Q trace data, the maximum magnitude of the I/Q pairs is returned.
- MEAN - returns a single value that is the arithmetic mean of the data point values (in dB/ dBm) for the specified region(s) of trace data. For I/Q trace data, the mean of the magnitudes of the I/Q pairs is returned. See the following equations.

**NOTE** If the original trace data is in dB, this function returns the arithmetic mean of those log values, not log of the mean power which is a more useful value. The mean of the log is the better measurement technique when measuring CW signals in the presence of noise. The mean of the power, expressed in dB, is useful in power measurements such as Channel Power. To achieve the mean of the power, use the RMS option.

Equation 1

Mean Value of Data Points for Specified Region(s)

$$MEAN = \frac{1}{n} \sum_{X_i \in \text{region}(s)} X_i$$

where  $X_i$  is a data point value, and  $n$  is the number of data points in the specified region(s).

Equation 2

Mean Value of I/Q Data Pairs for Specified Region(s)

$$MEAN = \frac{1}{n} \sum_{X_i \in \text{region}(s)} |X_i|$$

where  $|X_i|$  is the magnitude of an I/Q pair, and  $n$  is the number of I/Q pairs in the specified region(s).

- DMEan - returns a single value that is the mean power (in dB/ dBm) of the data point values for the specified region(s) of trace data. See the following equation:

Equation 3

DMEan Value of Data Points for Specified Region(s)



$$\text{DME} = 10 \times \log_{10} \left( \frac{1}{n} \sum_{X_i \in \text{region}(s)} 10^{\frac{X_i}{10}} \right)$$

- RMS - returns a single value that is the average power on a root-mean-squared voltage scale (arithmetic rms) of the data point values for the specified region(s) of trace data. See the following equation.

**NOTE**

For I/Q trace data, the rms of the magnitudes of the I/Q pairs is returned. See the following equation. This function is very useful for I/Q trace data. However, if the original trace data is in dB, this function returns the rms of the log values which is not usually needed.

Equation 4

RMS Value of Data Points for Specified Region(s)

$$\text{RMS} = \sqrt{\frac{1}{n} \sum_{X_i \in \text{region}(s)} X_i^2}$$

where  $X_i$  is a data point value, and  $n$  is the number of data points in the specified region(s).

Equation 5

RMS Value of I/Q Data Pairs for Specified Region(s)

$$\text{RMS} = \sqrt{\frac{1}{n} \sum_{X_i \in \text{region}(s)} X_i X_i^*}$$

where  $X_i$  is the complex value representation of an I/Q pair,  $X_i^*$  its conjugate complex number, and  $n$  is the number of I/Q pairs in the specified region(s).

Once you have the rms value for a region of trace data (linear or I/Q), you may want to calculate the mean power. You must convert this rms value (peak volts) to power in dBm:

$$10 \times \log[10 \times (\text{rms value})^2]$$

- SAMPLe - returns the first data value (x,y pair) for the specified region(s) of trace data. For I/Q trace data, the first I/Q pair is returned.
- SDEViation - returns a single value that is the arithmetic standard deviation for the data point values for the specified region(s) of trace data. See the following equation.
- For I/Q trace data, the standard deviation of the magnitudes of the I/Q pairs is returned. See the following equation.

Equation 6

Standard Deviation of Data Point Values for Specified Region(s)

$$\text{SDEV} = \sqrt{\frac{1}{n} \sum_{X_i \in \text{region}(s)} (X_i - \bar{X})^2}$$

where  $X_i$  is a data point value,  $\bar{X}$  is the arithmetic mean of the data point values for the specified region (s), and  $n$  is the number of data points in the specified region(s).

$$\text{SDEV} = \sqrt{\frac{1}{n} \sum_{X_i \in \text{region}(s)} (|X_i| - \bar{X})^2}$$

where  $|X_i|$  is the magnitude of an I/Q pair,  $\bar{X}$  is the mean of the magnitudes for the specified region(s), and  $n$  is the number of data points in the specified region(s).

- PPHase - returns the x,y pairs of both rms power (dBm) and arithmetic mean phase (radian) for every specified region and frequency offset (Hz). The number of pairs is defined by the specified number of regions. This parameter can be used for I/Q vector ( $n=0$ ) in Waveform (time domain) measurement and all parameters are specified by data point in PPHase.

The rms power of the specified region may be expressed as:

$$\text{Power} = 10 \times \log [10 \times (\text{RMS I/Q value})] + 10.$$

The RMS I/Q value (peak volts) is:

$$\sqrt{\frac{1}{n} \sum_{X_i \in \text{region}} X_i X_i^*}$$

where  $X_i$  is the complex value representation of an I/Q pair,  $X_i^*$  its conjugate complex number, and  $n$  is the number of I/Q pairs in the specified region.

The arithmetic mean phase of the specified region may be expressed as:

$$\frac{1}{n} \sum_{Y_i \in \text{region}} Y_i$$

where  $Y_i$  is the unwrapped phase of I/Q pair with applying frequency correction and  $n$  is the number of I/Q pairs in the specified region.

The frequency correction is made by the frequency offset calculated by the arithmetic mean of every specified region's frequency offset. Each frequency offset is calculated by the least square method against the unwrapped phase of I/Q pair.

Sample Trace Data - Constant Envelope

(See below for explanation of variables.)

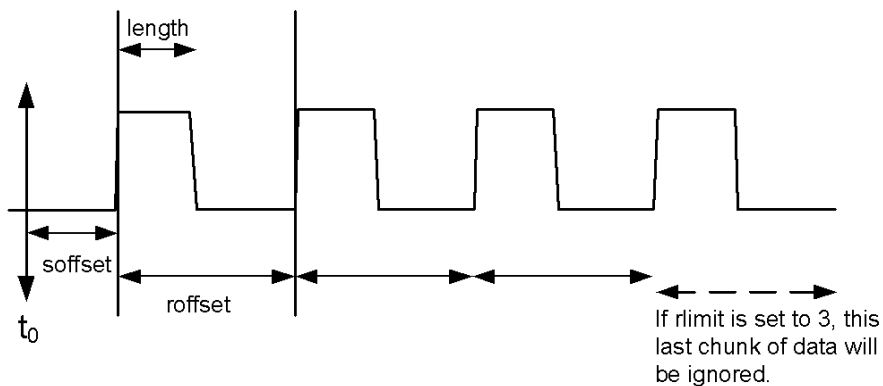

### Sample Trace Data - Not Constant Envelope

(See below for explanation of variables.)



<soffset> - start offset is an optional real number. (It is in seconds for time-domain traces, and is a dimensionless index 0 to Npoints - 1, for frequency-domain traces). It specifies the amount of data at the beginning of the trace that will be ignored before the decimation process starts. It is the time or frequency change from the start of the trace to the point where you want to start using the data. The default value is zero.

<length> - is an optional real number. (It is in seconds for time-domain traces, and is a dimensionless index 0 to Npoints - 1, for frequency-domain traces). It defines how much data will be compressed into one value. This parameter has a default value equal to the current trace length.

<roffset> - repeat offset is an optional real number. (It is in seconds for time-domain traces, and is a dimensionless index 0 to Npoints - 1, for frequency-domain traces). It defines the beginning of the next field of trace elements to be compressed. This is relative to the beginning of the previous field. This parameter has a default value equal to the <length> variable. Note that this parameter is used for a completely different purpose when curve fitting (see CFIT above).

<rlimit> - repeat limit is an optional integer. It specifies the number of data items that you want returned. It will ignore any additional items beyond that number. You can use the Start offset and the Repeat limit to pick out exactly what part of the data you want to use. The default value is all the data.

## Calculate Peaks of Trace Data (Remote Command Only)

Returns a list of all the peaks for the currently selected measurement and sub-opcode [n]. The peaks must meet the requirements of the peak threshold and excursion values.

n = any valid sub-opcode for the current measurement. See the MEASure:<measurement> command description of your specific measurement for information on the data that can be returned.

The command can only be used with specific sub-opcodes with measurement results that are trace data. Both real and complex traces can be searched, but complex traces are converted to magnitude in dBm. In many measurements the sub-opcode n=0, is the raw trace data which cannot be searched for peaks. And Sub-opcode n=1, is often calculated results values which also cannot be searched for peaks.

This command uses the data setting specified by the FORMat:BORDER and FORMat:DATA commands and can return real or ASCII data. If the format is set to INT,32, it returns REAL,32 data.

The command has four types of parameters:

- Threshold (in dBm)
- Excursion (in dB)
- Sorting order (amplitude, frequency, time)
- Optional in some measurements: Display line use (all, > display line, < display line)

---

<b>Remote Command</b>	<p>For Swept SA measurement:</p> <pre>:CALCulate:DATA[1] 2 ... 6:PEAKs? &lt;threshold&gt;,&lt;excursion&gt;[,AMPLitude   FREQuency   TIME[,ALL   GTDLine   LTDLine]]</pre> <p>For most other measurements:</p> <pre>:CALCulate:DATA[1] 2 ... 6:PEAKs? &lt;threshold&gt;,&lt;excursion&gt;[,AMPLitude   FREQuency   TIME]</pre>
-----------------------	--

---

<b>Example</b>	<p>Example for Swept SA measurement in Spectrum Analyzer Mode:</p> <p>CALC:DATA4:PEAK? -40, 10, FREQ, GTDL This will identify the peaks of trace 4 that are above -40 dBm, with excursions of at least 10 dB. The peaks are returned in order of increasing frequency, starting with the lowest frequency. Only the peaks that are above the display line are returned.</p> <p>Query Results 1:</p> <p>With FORMat:DATA REAL, 32 selected, it returns a list of floating-point numbers. The first value in the list is the number of peak points that are in the following list. A peak point consists of two values: a peak amplitude followed by its corresponding frequency (or time).</p> <p>If no peaks are found the peak list will consist of only the number of peaks, (0).</p>
----------------	---

---

<b>Notes</b>	<p>&lt;n&gt; - is the trace that will be used</p> <p>&lt;threshold&gt; - is the level below which trace data peaks are ignored. Note that the threshold value is required and is always used as a peak criterion. To effectively disable the threshold criterion for this command, provide a substantially low threshold value such as -200 dBm. Also note that the threshold value used in this command is independent of and has no effect on the threshold value stored under the Peak Criteria menu.</p> <p>&lt;excursion&gt; - is the minimum amplitude variation (rise and fall) required for a signal to be identified as peak. Note that the excursion value is required and is always used as a peak criterion. To effectively disable the excursion criterion for this command, provide the minimum value of 0.0 dB. Also note that the excursion value used in this command is independent of and has no effect on the</p>
--------------	---

---

excursion value stored under the Peak Criteria menu.

Values must be provided for threshold and excursion. The sorting and display line parameters are optional (defaults are AMPLitude and ALL).

Note that there is always a Y-axis value for the display line, regardless of whether the display line state is on or off. It is the current Y-axis value of the display line which is used by this command to determine whether a peak should be reported

Sorting order:

AMPLitude - lists the peaks in order of descending amplitude, with the highest peak first (default if optional parameter not sent)

FREQUency - lists the peaks in order of occurrence, left to right across the x-axis.

TIME - lists the peaks in order of occurrence, left to right across the x-axis.

Peaks vs. Display Line:

ALL - lists all of the peaks found (default if optional parameter not sent).

GTDLine (greater than display line) - lists all of the peaks found above the display line.

LTDLine (less than display line) - lists all of the peaks found below the display line.

Initial S/W Revision      Prior to A.02.00

### Format Data: Numeric Data (Remote Command Only)

This command specifies the format of the trace data input and output. It specifies the formats used for trace data during data transfer across any remote port. It affects only the data format for setting and querying trace data for the :TRACe[:DATA], TRACe[:DATA]?, :CALCulate:DATA[n]? and FETCh:SANalyzer [n]? commands and queries.

**Remote Command**      :FORMat[:TRACe] [:DATA] ASCii|INTeger,32|REAL,32 |REAL,64  
:FORMat[:TRACe] [:DATA] ?

**Notes**      The query response is:  
ASCii: ASC,8  
REAL,32: REAL,32  
REAL,64: REAL,64  
INTeger,32: INT,32

When the numeric data format is REAL or ASCii, data is output in the current Y Axis unit. When the data format is INTeger, data is output in units of m dBm (.001 dBm).

The INT,32 format returns binary 32-bit integer values in internal units (m dBm), in a definite length block.

**Dependencies**      Sending a data format spec with an invalid number (for example, INT,48) generates no error. The analyzer simply uses the default (8 for ASCii, 32 for INTeger, 32 for REAL).

Sending data to the analyzer which does not conform to the current FORMat specified, results in an error. Sending ASCII data when a definite block is expected generates message -161 "Invalid Block Data" and sending a definite block when ASCII data is expected generates message -121 "Invalid Character in Number".

**Preset**      ASCii

**Backwards Compatibility Notes**      Note that the INT,32 format is only applicable to the command, TRACe:DATA. This preserves backwards compatibility for the Swept SA measurement. For all other commands/queries which honor FORMat:DATA, if INT,32 is sent the analyzer will behave as though it were set to REAL,32.

Initial S/W Revision      Prior to A.02.00

The specs for each output type follow:

ASCIi - Amplitude values are in ASCII, in the current Y Axis Unit, one ASCII character per digit, values separated by commas, each value in the form:

SX.YYYYYEsZZ

Where:

S = sign (+ or -)

X = one digit to left of decimal point

Y = 5 digits to right of decimal point

E = E, exponent header

s = sign of exponent (+ or -)

ZZ = two digit exponent

REAL,32 - Binary 32-bit real values in the current Y Axis Unit, in a definite length block.

REAL,64 - Binary 64-bit real values in the current Y Axis Unit, in a definite length block.

### Format Data: Byte Order (Remote Command Only)

This command selects the binary data byte order for data transfer and other queries. It controls whether binary data is transferred in normal or swapped mode. This command affects only the byte order for setting and querying trace data for the :TRACe[:DATA], TRACe[:DATA]? , :CALCulate:DATA[n]? and FETCh:SANalyzer[n]? commands and queries.

By definition any command that says it uses FORMat:DATA uses any format supported by FORMat:DATA.

The NORMal order is a byte sequence that begins with the most significant byte (MSB) first, and ends with the least significant byte (LSB) last in the sequence: 1|2|3|4. SWAPped order is when the byte sequence begins with the LSB first, and ends with the MSB last in the sequence: 4|3|2|1.

---

<b>Remote Command</b>	:FORMat:BORDER NORMal   SWAPped :FORMat:BORDER?
<b>Preset</b>	NORMal
<b>Initial S/W Revision</b>	Prior to A.02.00

---

## Meas Setup

Displays the menu keys that enable you to setup the measurement.

Key Path	Front-panel key
Notes	Front panel only.
State Saved	Saved in instrument state.
Initial S/W Revision	A.07.00

## Analog Demod Tune & Listen

The Analog Demod Tune & Listen key opens the Analog Demod menu that contains keys to turn the demod function on and off and select the modulation type.

Key Path	Meas Setup
<b>Remote Command</b>	[ :SENSe ] :SCHart:DEMod AM FM PM OFF [ :SENSe ] :SCHart:DEMod?
<b>Example</b>	SCH:DEM AM SCH:DEM?
Dependencies	When Tune & Listen is turned on, only Meter 1 will return the valid measurement result. Meter 2 & 3 will return -1000dBm. Meter 2 & 3 will return valid measurement results when Turn & Listen is turned off.
Preset	OFF
State Saved	Saved in instrument state.
Range	AM FM PM OFF
Initial S/W Revision	A.07.00

## AM

Pressing this key, when it is not selected, selects and activates the AM demodulation function.

Key Path	Meas Setup, Analog Demod Tune&Listen
<b>Example</b>	SCH:DEM AM Turns AM demodulation function ON.
State Saved	Saved in instrument state.
Initial S/W Revision	A.07.00

## FM

Pressing this key, when it is not selected, selects and activates the FM demodulation function. Pressing it a second time branches to the FM Demod menu where FM demodulation settings can be adjusted.

Key Path	Meas Setup, Analog Demod Tune&Listen
<b>Example</b>	SCH:DEM FM Turns FM demodulation function ON.
State Saved	Saved in instrument state.
Initial S/W Revision	A.07.00

## De-emphasis (FM Demod Only)

The De-emphasis setting controls a single-pole filter (6 dB/octave roll off), usually to counter intentional pre-emphasis in the transmitter. When the De-emphasis state is OFF the hardware digital filter is bypassed, otherwise the setting is applied.

Key Path	Meas Setup, Analog Demod, FM
<b>Remote Command</b>	[ :SENSe ] :SCHart:DEMod:FM:DEEMphasis OFF US25 US50 US75 US750 [ :SENSe ] :SCHart:DEMod:FM:DEEMphasis?
<b>Example</b>	SCH:DEM:FM:DEEM US75 SCH:DEM:FM:DEEM?
Notes	Only available in FM. Grayed out for AM and PM.
Preset	US75
State Saved	Saved in instrument state.
Range	OFF US25 US50 US75 US750
Initial S/W Revision	A.07.00

## Off

This setting bypasses the De-emphasis filter.

Key Path	Meas Setup, Analog Demod Tune&Listen, FM, De-emphasis
<b>Example</b>	SCH:DEM:FM:DEEM OFF
Readback	Off
Initial S/W Revision	A.07.00



25  $\mu$ s

Sets the De-emphasis time constant to 25 $\mu$ s.

Key Path	Meas Setup, Analog Demod Tune&Listen, FM, De-emphasis
<b>Example</b>	SCH:DEM:FM:DEEM US25
Readback	25 $\infty$ s
Initial S/W Revision	A.07.00

50  $\mu$ s

Sets the De-emphasis time constant to 50  $\mu$ s.

Key Path	Meas Setup, Analog Demod Tune&Listen, FM, De-emphasis
<b>Example</b>	SCH:DEM:FM:DEEM US50
Readback	50 $\infty$ s
Initial S/W Revision	A.07.00

75  $\mu$ s

Sets the De-emphasis time constant to 75  $\mu$ s.

Key Path	Meas Setup, Analog Demod Tune&Listen, FM, De-emphasis
<b>Example</b>	SCH:DEM:FM:DEEM US75
Readback	75 $\infty$ s
Initial S/W Revision	A.07.00

750  $\mu$ s

Sets the De-emphasis time constant to 750  $\mu$ sec.

Key Path	Meas Setup, Analog Demod Tune&Listen, FM, De-emphasis
<b>Example</b>	SCH:DEM:FM:DEEM US750
Readback	750 $\infty$ s
Initial S/W Revision	A.07.00

## ΦM

Pressing this key, when it is not selected, selects and activates the ΦM demodulation function

Key Path	Meas Setup, Analog Demod Tune&Listen
State Saved	Saved in instrument state.
Initial S/W Revision	A.07.00

## Off

Pressing this key, turns the demodulation function off.

Key Path	Meas Setup, Analog Demod
<b>Example</b>	:SCH:DEM OFF Turns off demodulation function.
State Saved	Saved in instrument state
Initial S/W Revision	A.07.00

## Limit Fail? (Remote Command Only)

Tests meter limits against its history traces. Returns a 0 if the history traces are within the limit, a 1 if history traces exceeds meter limits.

<b>Remote Command</b>	:CALCulate:SCHart:LIMit:FAIL?
<b>Example</b>	CALC:SCH:LIM:FAIL? Returns a zero if limit line 1's associated trace has no failure, 1 if there is a margin or limit failure.
Initial S/W Revision	A.07.00

## Meas Preset

This key returns the Meas Local variables in the Strip Chart measurement to their preset values. This is the same as sending the SCPI command CONF:SCH

Key Path	Meas Setup
Initial S/W Revision	A.07.00

## Mode

See "Mode" on page 222

## Mode Preset

Returns the active mode to a known state.

Mode Preset does the following for the currently active mode:

- Aborts the currently running measurement.
- Brings up the default menu for the mode, with no active function.
- Sets measurement Global settings to their preset values for the active mode only.
- Activates the default measurement.
- Brings up the default menu for the mode.
- Clears the input and output buffers.
- Sets Status Byte to 0.

Mode Preset does not:

- Cause a mode switch
- Affect mode persistent settings
- Affect system settings

See "[How-To Preset](#)" on page 661 for more information.

<b>Key Path</b>	Front-panel key
<b>Remote Command</b>	:SYSTem:PRESet
<b>Example</b>	:SYST:PRES
<b>Notes</b>	*RST is preferred over :SYST:PRES for remote operation. *RST does a Mode Preset, as done by the :SYST:PRES command, and it sets the measurement mode to Single measurement rather than Continuous for optimal remote control throughput. Clears all pending OPC bits. The Status Byte is set to 0.
<b>Couplings</b>	A Mode Preset aborts the currently running measurement, activates the default measurement, and gets the mode to a consistent state with all of the default couplings set.
<b>Backwards Compatibility Notes</b>	In the X-Series, the legacy "Factory Preset" has been replaced with Mode Preset, which only presets the currently active mode, not the entire instrument. In the X-Series, the way to preset the entire instrument is by using System, Restore System Defaults All, which behaves essentially the same way as restore System Defaults does on ESA and PSA. There is also no "Preset Type" as there is on the PSA. There is a green Mode Preset front-panel key that does a Mode Preset and a white-with-green-letters User Preset front-panel key that does a User Preset. The old PRESet:TYPE command is ignored (without generating an error), and SYST:PRES without a parameter does a Mode Preset, which should cover most backward code compatibility issues. The settings and correction data under the Input/Output front-panel key (examples: Input Z Corr, Ext Amp Gain, etc.) are no longer part of any Mode, so they will not be preset by a Mode Preset. They are preset using Restore Input/Output Defaults, Restore System Defaults All. Note that because User Preset does a Recall State, and all of these settings are saved in State, they ARE recalled when using

	User Preset.
Initial S/W Revision	Prior to A.02.00

## How-To Preset

The table below shows all possible presets, their corresponding SCPI commands and front-panel access (key paths). Instrument settings depend on the current measurement context. Some settings are local to the current measurement, some are global (common) across all the measurements in the current mode, and some are global to all the available modes. In a similar way, restoring the settings to their preset state can be done within the different contexts.

Auto Couple - is a measurement local key. It sets all Auto/Man parameter couplings in the measurement to Auto. Any Auto/Man selection that is local to other measurements in the mode will not be affected.

Meas Preset - is a measurement local key. Meas Preset resets all the variables local to the current measurement except the persistent ones.

Mode Preset - resets all the current mode's measurement local and measurement global variables except the persistent ones.

Restore Mode Defaults - resets ALL the Mode variables (and all the Meas global and Meas local variables), including the persistent ones.

Type Of Preset	SCPI Command	Front Panel Access
Auto Couple	:COUPlE ALL	Auto Couple front-panel key
Meas Preset	:CONFIgure:<Measurement>	Meas Setup Menu
Mode Preset	:SYSTem:PRESet	Mode Preset (green key)
Restore Mode Defaults	:INSTrument:DEFault	Mode Setup Menu
Restore All Mode Defaults	:SYSTem:DEFault MODEs	System Menu; Restore System Default Menu
*RST	*RST	not possible (Mode Preset with Single)
Restore Input/Output Defaults	:SYSTem:DEFault INPut	System Menu; Restore System Default Menu
Restore Power On Defaults	:SYSTem:DEFault PON	System Menu; Restore System Default Menu
Restore Alignment Defaults	:SYSTem:DEFault ALIGn	System Menu; Restore System Default Menu
Restore Miscellaneous Defaults	:SYSTem:DEFault MISC	System Menu; Restore System Default Menu
Restore All System Defaults	:SYSTem:DEFault [ALL] :SYSTem:PRESet:PERSistent	System Menu; Restore System Default Menu
User Preset	:SYSTem:PRESet:USER	User Preset Menu
User Preset All Modes	:SYSTem:PRESet:USER:ALL	User Preset Menu

9 Strip Chart Measurement  
Mode Preset

Power On Mode Preset	:SYSTem:PON:TYPE MODE	System Menu
Power On User Preset	:SYSTem:PON:TYPE USER	System Menu
Power On Last State	:SYSTem:PON:TYPE LAST	System Menu

## Mode Setup

See "Mode Setup" on page 246

## Peak Search

Displays the Peak Search menu and places the selected marker on the trace point with the maximum y-axis value for that marker's trace. If the selected marker is off, it is turned on as a normal marker and a peak search is performed.

Key Path	Front-panel key
<b>Remote Command</b>	:CALCulate:SCart:MARKer[1] 2 ...12:MAXimum
<b>Example</b>	CALC:SCH:MARK2:MAX
State Saved	No
Initial S/W Revision	A.07.00

## Next Peak

Moves the selected marker to the next highest local maximum with a value less than the current marker's. If the selected marker is off, it is turned on as a normal marker and a peak search is performed.

Key Path	Peak Search
<b>Remote Command</b>	:CALCulate:SCart:MARKer[1] 2 ...12:MAXimum:NEXT
<b>Example</b>	CALC:SCH:MARK:MAX:NEXT
State Saved	No
Initial S/W Revision	A.07.00

## Min Search

Moves the selected marker to the minimum y-axis value on the current trace. If the selected marker is off, it is turned on as a normal marker and a peak search is performed.

Key Path	Peak Search
<b>Remote Command</b>	:CALCulate:SCart:MARKer[1] 2 ...12:MINimum
<b>Example</b>	CALC:SCH:MARK:MIN
State Saved	No
Initial S/W Revision	A.07.00



Print

See "Print" on page 271

## Quick Save

The Quick Save front-panel key repeats the most recent save that was performed from the Save menu, with the following exceptions:

- Register saves are not remembered as Saves for the purpose of the Quick Save function
- If the current measurement does not support the last non-register save that was performed, an informational message is generated, “File type not supported for this measurement”

Quick Save repeats the last type of qualified save (that is, a save qualified by the above criteria) in the last save directory by creating a unique filename using the Auto File Naming algorithm described below.

If Quick Save is pressed after startup and before any qualified Save has been performed, the Quick Save function performs a Screen Image save using the current settings for Screen Image saves (current theme, current directory), which then becomes the “last save” for the purpose of subsequent Quick Saves.

The Auto File Naming feature automatically generates a file name for use when saving a file. The filename consists of a prefix and suffix separated by a dot, as is standard for the Windows® file system. A default prefix exists for each of the available file types:

Type	Default Prefix	Menu
State	State_	(Save/Recall)
Trace + State	State_	(Save/Recall)
Screen	Screen_	(Save/Recall)
Amplitude Corrections	Ampcor_	(Import/Export)
Traces	Trace_	(Import/Export)
Limit Lines	LLine_	(Import/Export)
Measurement Result	MeasR_	(Import/Export)
Capture Buffer	CapBuf_	(Import/Export)

A four digit number is appended to the prefix to create a unique file name. The numbering sequence starts at 0000 within each Mode for each file type and updates incrementally to 9999, then wraps to 0000 again. It remembers where it was through a Mode Preset and when leaving and returning to the Mode. It is reset by Restore Misc Defaults and Restore System Defaults and subsequent running of the instrument application. So, for example, the first auto file name generated for State files is State\_0000.state. The next is State\_0001, and so forth.

One of the key features of Auto File Name is that we guarantee that the Auto File Name will never conflict with an existing file. The algorithm looks for the next available number. If it gets to 9999, then it looks for holes. If it find no holes, that is no more numbers are available, it gives an error.

For example, if when we get to State\_0010.state there is already a State\_0010.state file in the current directory, it advances the counter to State\_0011.state to ensure that no conflict will exist (and then it verifies that State\_0011.state also does not exist in the current directory and advances again if it does, and so forth).

If you enter a file name for a given file type, then the prefix becomes the filename you entered instead of the default prefix, followed by an underscore. The last four letters (the suffix) are the 4-digit number.

For example, if you save a measurement results file as "fred.csv", then the next auto file name chosen for a measurement results save will be fred\_0000.csv.

**NOTE** Although 0000 is used in the example above, the number that is used is actually the current number in the Meas Results sequence, that is, the number that would have been used if you had not entered your own file name.

**NOTE** If the filename you entered ends with \_dddd, where d=any number, making it look just like an auto file name, then the next auto file name picks up where you left off with the suffix being dddd + 1.

Key Path	Front-panel key
Notes	No remote command for this key specifically.
Initial S/W Revision	Prior to A.02.00

## Recall

The recall key accesses the menu that allows you to load a measurement state and data from external files or registers.

Key Path	Front-panel key
Initial S/W Revision	A.07.00

### State

The Recall State menu lets you choose a register or file from which to recall the state.

The content of a state file includes all of the settings and data required to return the analyzer as closely as possible to the Mode it was in, with the exact settings that were in place, when the save occurred. The Mode settings in each state file include the settings that are affected by Mode Preset, as well as the additional settings affected by Restore Mode Defaults; all of the Mode's settings. In addition, all of the settings of the Input/Output system are included, even though they are outside of the Mode's state, because they are needed to restore the complete setup. Persistent System settings (for example, GPIB address) are not affected by either a Mode Preset or Restore Mode Defaults, nor are they included in a saved State file.

Since each state file is only for one Mode, the settings for other Modes are unaffected when it is loaded. Recall State will cause a mode switch if the state being recalled is not from the current active mode.

After the recall completes, the message "File <filename> recalled" or "Recalled State Register <register number>" is displayed.

For rapid recalls, the State menu lists 16 registers that you can choose from to recall. Pressing a Register key initiates the recall. You can also select a file from which to recall.

The default path for all State Files is:

My Documents\<<mode name>\state

where <mode name> is the parameter used to select the mode with the INST:SEL command (for example, SA for the Spectrum Analyzer).

See "[More Information](#)" on page 669.

Key Path	Recall
Mode	All
<b>Remote Command</b>	:MMEMory:LOAD:STATe <filename>
<b>Example</b>	:MMEM:LOAD:STAT "myState.state" This recalls the file myState.state on the default path
<b>Example</b>	MMEM:LOAD:STAT "MyStateFile.state" This loads the state file data (on the default file directory path) into the instrument state.
Notes	When you pick a file to recall, the analyzer first verifies that the file is recallable in the current instrument by checking the software version and model number of the instrument. If everything

matches, a full recall proceeds by aborting the currently running measurement, clearing any pending operations, and then loading the State from the saved state file. You can open state files from any mode, so recalling a State file switches to the mode that was active when the save occurred. After switching to the mode of the saved state file, mode settings and data (if any for the mode) are loaded with values from the saved file. The saved measurement of the mode becomes the newly active measurement and the data relevant to the measurement (if there is any) is recalled.

If there is a mismatch between file version or model number or instrument version or model number, the recall function tries to recall as much as possible and returns a warning message. It may limit settings that differ based on model number, licensing or version number.

After recalling the state, the Recall State function does the following:

- Makes the saved measurement for the mode the active measurement.
- Clears the input and output buffers.
- Status Byte is set to 0.
- Executes a \*CLS

If the file specified is empty an error is generated. If the specified file does not exist, another error is generated. If there is a mismatch between the file and the proper file type, an error is generated. If there is a mismatch between file version or model number or instrument version or model number, a warning is displayed. Then it returns to the State menu and File Open dialog goes away.

After the Recall, the analyzer exits the Recall menu and returns to the previous menu.

<b>Backwards Compatibility SCPI</b>	:MMEMory:LOAD:STATe 1,<filename>
Initial S/W Revision	Prior to A.02.00

## More Information

In measurements that support saving Traces, for example, Swept SA, the Trace data is saved along with the State in the State file. When recalling the State, the Trace data is recalled as well. Traces are recalled exactly as they were stored, including the writing mode and update and display modes. If a Trace was updating and visible when the State was saved, it will come back updating and visible, and its data will be rewritten right away. When you use State to save and recall traces, any trace whose data must be preserved should be placed in View or Blank mode before saving.

The following table describes the Trace Save and Recall possibilities:

You want to recall state and one trace's data, leaving other traces unaffected.	Save Trace+State from 1 trace. Make sure that no other traces are updating (they should all be in View or Blank mode) when the save is performed.	On Recall, specify the trace you want to load the one trace's data into. This trace will load in View. All other traces' data will be unaffected, although their trace mode will be as it was when the state save was performed.
You want to recall all traces	Save Trace+State from ALL traces.	On Recall, all traces will come back in View (or Blank if they were in Blank or Background when saved)

You want all traces to load exactly as they were when saved.

Save State

On recall, all traces' mode and data will be exactly as they were when saved. Any traces that were updating will have their data immediately overwritten.

### From File...

When you press “From File”, the analyzer brings up a Windows dialog and a menu entitled “File Open.” This menu allows you to navigate to the various fields in the Windows dialog without using a keyboard or mouse. The Tab and Arrow keys can also be used for dialog navigation.

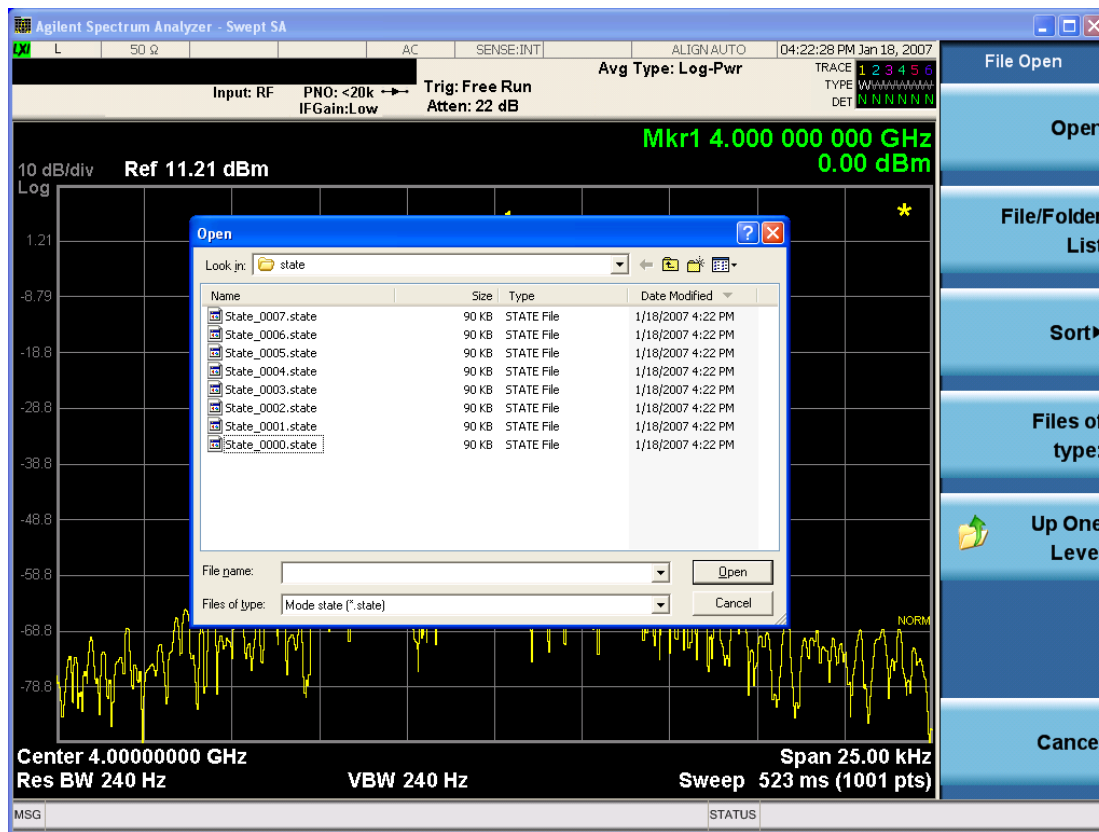

Listed below are the functions of the various fields in the dialog, and the corresponding softkeys:

#### Open

Performs the recall of the specified file. While the recall is being performed, the floppy icon appears briefly in the Meas bar.

#### File/Folder List

Enables you to navigate to the center of the dialog that contains the list of files and folders. Once here you can get information about the file and use the tab keys to navigate to the other fields in the dialog, such as Look In.

## Look In

The Look In field shows the path from which the file will be recalled and allows you to change the path using the up and down arrow keys to navigate to other paths; the Enter key to open a directory; and the Backspace key to go back one directory. The **Look In field** first uses the last path from the Save As dialog **Save In**: path for that same file type. There is no softkey for directly navigating to the Look In field, but you can use the left tab to get here from the File/Folder List.

User specified paths are remembered when you leave and return to a Mode and are reset back to the default using Restore Mode Defaults.

## Sort

Accesses a menu that enables you to sort the files within the File Open dialog. Only one sorting type can be selected at a time and the sorting happens immediately. The sorting types are By Date, By Name, By extension, and By Size.

## Files of Type

This field shows the file suffix for the type of file you have selected to recall. For example, if you navigated here while recalling State, "Mode state (\*.state)" is in the field. If you navigated here while recalling Trace, ""Mode state (\*.trace)" is in the field. If you navigated here while importing a trace data file, "Trace Data (\*.csv)" is in the field. For some file types, there is more than one choice in the dropdown menu, which you can select by using the up and down arrow keys and Enter.

## Up One Level

This key corresponds to the icon of a folder with the up arrow that is in the tool bar of the dialog. When pressed, it causes the file and folder list to navigate up one level in the directory structure. The Backspace key does the same thing.

## Cancel

This key corresponds to the Cancel selection in the dialog. It causes the current **Open** request to be cancelled. The ESC key does the same thing.

Key Path	Recall, State
Notes	Brings up the Open dialog for recalling a State Save Type
Initial S/W Revision	Prior to A.02.00

## Edit Register Names

You may enter a custom name on any of the Register keys, to help you remember what you are using that state to save. To do this, press the Edit Register Names key, choose the register whose name you wish to edit, and then enter the desired label using the Alpha Editor or an external PC keyboard.

The maximum number of characters that can be added is 30. In most cases, 30 characters will fit on two lines of the key.

For more information and the SCPI command, see Edit Register Names under the Save, State function.

Key Path	Recall, State
Mode	All
Dependencies	N9060A-7FP or N9060B-2FP license required to edit the register names. When the feature is not licensed, sending the SCPI command generates an error, -221, "Settings conflict;Option not available"
Initial S/W Revision	A.11.00

### Register 1 thru Register 16

Selecting any one of these register keys causes the State of the mode from the specified Register to be recalled. Each of the register keys annotates whether it is empty or at what date and time it was last modified. In addition, you can use the Edit Register Names key under Save, State to enter custom names for each register.

Registers are shared by all modes, so recalling from any one of the registers will cause a mode switch to the mode that was active when the save to the Register occurred.

Although these 16 registers are the only registers available from the front panel, there are 128 state registers available in the instrument. Registers 17-128 are only available from the SCPI interface, using the \*RCL command.

After the recall completes, the message "Register <register number> recalled" appears in the message bar. If you are in the Spectrum Analyzer Mode, and you are recalling a register that was saved in the Spectrum Analyzer Mode, then after the recall, you will still be in the Recall Register menu. If the Recall causes you to switch modes, then after the Recall, you will be in the Frequency menu.

If a requested register is empty an error is generated.

Key Path	Recall, State
<b>Example</b>	*RCL 1
Range	1-16 from front panel, 1-128 from SCPI
Readback	Date and time with seconds resolution are displayed on the key OR A custom name of up to 30 characters entered using the Save, State, Edit Register Names key OR “(empty)” if no prior save operation has been performed to this register.
Initial S/W Revision	Prior to A.02.00
Modified at S/W Revision	Prior to A.11.00

### Register 1 thru Register 16

Selecting any one of these register keys causes the State of the mode from the specified Register to be recalled. Each of the register keys annotates whether it is empty or at what date and time it was last



modified. In addition, you can use the Edit Register Names key under Save, State to enter custom names for each register.

Registers are shared by all modes, so recalling from any one of the registers will cause a mode switch to the mode that was active when the save to the Register occurred.

Although these 16 registers are the only registers available from the front panel, there are 128 state registers available in the instrument. Registers 17–128 are only available from the SCPI interface, using the \*RCL command.

After the recall completes, the message "Register <register number> recalled" appears in the message bar. If you are in the Spectrum Analyzer Mode, and you are recalling a register that was saved in the Spectrum Analyzer Mode, then after the recall, you will still be in the Recall Register menu. If the Recall causes you to switch modes, then after the Recall, you will be in the Frequency menu.

If a requested register is empty an error is generated.

Key Path	Recall, State
<b>Example</b>	*RCL 1
Range	1–16 from front panel, 1–128 from SCPI
Readback	Date and time with seconds resolution are displayed on the key OR A custom name of up to 30 characters entered using the Save, State, Edit Register Names key OR “(empty)” if no prior save operation has been performed to this register.
Initial S/W Revision	Prior to A.02.00
Modified at S/W Revision	Prior to A.11.00

## Data (Import)

Importing a data file loads data that was previously saved from the current measurement or from other measurements and/or modes that produce compatible data files. The Import Menu only contains Data Types that are supported by the current measurement.

Since the commonly exported data files are in .csv format, the data can be edited by the user prior to importing. This allows you to export a data file, manipulate the data in Excel (the most common PC Application for manipulating .csv files) and then import it.

Importing Data loads measurement data from the specified file into the specified or default destination, depending on the data type selected. Selecting an Import Data menu key will not actually cause the importing to occur, since the analyzer still needs to know from where to get the data. Pressing the Open key in this menu brings up the Open dialog and Open menu that provides you with the options from where to recall the data. Once a filename has been selected or entered in the Open menu, the recall occurs as soon as the Open button is pressed.

Key Path	Recall
Mode	All

Notes	The menu is built from whatever data types are available for the mode. Some keys will be missing completely, so the key locations in the sub-menu will vary. No SCPI command directly controls the Data Type that this key controls. The Data Type is included in the MMEM:LOAD commands.
Dependencies	If a file type is not used by a certain measurement, it is grayed out for that measurement. The key for a file type will not show at all if there are no measurements in the Mode that support it.
Preset	Is not affected by Preset or shutdown, but is reset during Restore Mode Defaults
Readback	The data type that is currently selected
Initial S/W Revision	Prior to A.02.00

## Amplitude Correction

This key selects the Amplitude Corrections as the data type to be imported. When pressed a second time, it brings up the Select Menu, which lets you select the Correction into which the data will be imported.

Amplitude Corrections are fully discussed in the documentation of the Input/Output key, under the Corrections key.

A set of preloaded Corrections files can be found in the directory

/My Documents/ EMC Limits and Ampcor.

When the Amplitude Correction is an Antenna correction and the Antenna Unit in the file is not None, the Y Axis Unit setting will change to match the Antenna Unit in the file.

Key Path	Recall
Mode	SA EDGE GSM PN
Remote Command	:MMEMory:LOAD:CORRection 1 2 3 4 5 6 7 8, <filename>
Example	:MMEM:LOAD:CORR 2, "myAmpcor.csv" recalls the Amplitude Correction data from the file myAmpcor.csv in the current directory to the 2nd Amplitude Correction table, and turns on Correction 2. The default path is D:\User_My_Documents\Instrument\My Documents\amplitudeCorrections\
Dependencies	Only the first correction array (Correction 1) supports antenna units. This means that a correction file with an Antenna Unit can only be loaded into the Corrections 1 register. Consequently only for Correction 1 does the dropdown in the Recall dialog include.ant, and if an attempt is made to load a correction file into any other Correction register which DOES contain an antenna unit, a Mass Storage error is generated. Corrections are not supported by all Measurements. If in a Mode in which some Measurements support it, this key will be grayed out in measurements that do not. The key will not show at all if no measurements in the Mode support it. Errors are reported if the file is empty or missing, or if the file type does not match, or if there is a mismatch between the file type and the destination data type. If any of these occur during manual operation, the analyzer returns to the Import Data menu and the File Open dialog goes away. This key does not appear unless you have the proper option installed in your instrument. This command will generate an "Option not available" error unless you have the proper option installed in your instrument.

Couplings	When a correction file is loaded from mass storage, it is automatically turned on ( <b>Correction ON</b> ) and <b>ApplyCorrections</b> is set to On. This allows you to see its effect, thus confirming the load.
Readback	selected Correction
<b>Backwards Compatibility SCPI</b>	:MMEMory:LOAD:CORRection ANTenna   CABLe   OTHer   USER, <filename> For backwards compatibility, ANTenna maps to 1, CABLe maps to 2, OTHer maps to 3 and USER maps to 4
Initial S/W Revision	A.02.00

### Default Directory

Specifies the default directory used for loading of Amplitude Correction. If user is selected, the default recall directory is the default (My Documents\amplitudeCorrections) or the last directory you saved the amplitude correction data to. Otherwise, the default recall directory is My Documents\EMC Limits and Ampcor\Ampcor, which contains a set of preloaded amplitude correction files in the directory called Ampcor.

Key Path	Recall, Export Data, Amplitude Correction
<b>Remote Command</b>	:MMEMory:LOAD:CORRection:DDIRectory USER PRELoaded
<b>Example</b>	:MMEM:LOAD:CORR:DDIR USER Select user :MMEM:LOAD:CORR:DDIR?
Notes	USER = User PRELoaded = Preloaded
Preset	PRELoaded
State Saved	Saved in instrument state.
Range	User  Preloaded
Readback	"User"  "Preloaded"
Initial S/W Revision	A.13.00

### Trace

This key selects Trace as the data type to be imported. When pressed a second time, it brings up the Trace Menu, which lets you select the Trace into which the data will be imported.

The trace file contains "meta" data which describes the state of the analyzer when the trace was exported (see ). If the meta data in the file does not match the current SA state, the "invalid data indicator" (\*) is displayed.

Key Path	Recall, Data
<b>Remote Command</b>	:MMEMory:LOAD:TRACe:DATA TRACE1 TRACE2 TRACE3,<filename>
<b>Example</b>	:MMEM:LOAD:TRAC DATA TRACE2, "myTrace2.csv" imports the 2nd trace from the file

	myTrace2.csv in the current path. The default path is My Documents\EMI\data\xxx\traces where xxx is the measurement name.
Dependencies	<p>A trace cannot be recalled from a trace file that was exported with ALL traces selected.</p> <p>A trace cannot be imported if the number of trace points in the file do not match the number of sweep points currently set for the measurement. If this happens, an error message is generated. Errors are reported if the file is empty or missing, or if the file type does not match, or if there is a mismatch between the file type and the destination data type.</p> <p>If any error occurs while trying to load a file manually (as opposed to during remote operation), the analyzer returns to the Import Data menu and the File Open dialog goes away.</p>
Couplings	When a trace is imported, <b>Trace Update</b> is always turned OFF for that trace and <b>Trace Display</b> is always turned ON.
Readback	1 2 3
Status Bits/OPC dependencies	Sequential - aborts the current measurement.
Initial S/W Revision	Prior to A.02.00

## Open...

When you press “Open”, the analyzer brings up a Windows dialog and a menu entitled “**File Open.**” This menu allows you to navigate to the various fields in the Windows dialog without using a keyboard or mouse. The Tab and Arrow keys can also be used for dialog navigation.

See "[From File...](#)" on page 1083 in Recall, State, for a full description of this dialog and menu.

Key Path	Recall, Data
Notes	<p>The key location is mode-dependent and will vary.</p> <p>Brings up Open dialog for recalling a &lt;mode specific&gt; Save Type</p>
Initial S/W Revision	Prior to A.02.00

## State

Most of the functions under this key work the same way in many measurements, so they are documented in the Utility Functions section. For details about this key, see "[State](#)" on page 1081.

## Data (Import)

Most of the functions under this key work the same way in many measurements, so they are documented in the Utility Functions section. For details about this key, see "[Data \(Import\)](#)" on page 1086.

## Amplitude Correction

Most of the functions under this key work the same way in many measurements. For details about this key, see "[Amplitude Correction](#)" on page 1087.

## Default Directory

Specifies the default directory used for loading of Amplitude Correction. If user is selected, the default recall directory is the default (My Documents\amplitudeCorrections) or the last directory you saved the amplitude correction data to. Otherwise, the default recall directory is My Documents\EMC Limits and Ampcor\Ampcor, which contains a set of preloaded amplitude correction files in the directory called Ampcor.

Key Path	Recall, Export Data, Amplitude Correction
Remote Command	:MMEMory:LOAD:CORRection:DDIRectory USER PRELoaded
Example	:MMEM:LOAD:CORR:DDIR USER Select user :MMEM:LOAD:CORR:DDIR?
Notes	USER = User PRELoaded = Preloaded
Preset	PRELoaded
State Saved	Saved in instrument state.
Range	User  Preloaded
Readback	"User"  "Preloaded"
Initial S/W Revision	A.13.00

## Trace

This key selects Trace as the data type to be imported. When pressed a second time, it brings up the Trace Menu, which lets you select the Trace into which the data will be imported.

The trace file contains "meta" data which describes the state of the analyzer when the trace was exported (see ). If the meta data in the file does not match the current SA state, the "invalid data indicator" (\*) is displayed.

Key Path	Recall, Data
Remote Command	:MMEMory:LOAD:TRACe:DATA TRACE1 TRACE2 TRACE3,<filename>
Example	:MMEM:LOAD:TRAC DATA TRACE2, "myTrace2.csv" imports the 2nd trace from the file myTrace2.csv in the current path. The default path is My Documents\EMI\data\xxx\traces where xxx is the measurement name.
Dependencies	A trace cannot be recalled from a trace file that was exported with ALL traces selected. A trace cannot be imported if the number of trace points in the file do not match the number of sweep points currently set for the measurement. If this happens, an error message is generated. Errors are reported if the file is empty or missing, or if the file type does not match, or if there is a mismatch between the file type and the destination data type. If any error occurs while trying to load a file manually (as opposed to during remote operation), the analyzer returns to the Import Data menu and the File Open dialog goes away.
Couplings	When a trace is imported, <b>Trace Update</b> is always turned OFF for that trace and <b>Trace Display</b> is always turned ON.

Readback	1 2 3
Status Bits/OPC dependencies	Sequential - aborts the current measurement.
Initial S/W Revision	Prior to A.02.00

### Limit

This key selects Limit Lines as the data type to be imported. When pressed a second time, it brings up the Limits Menu, which lets you select into which Limit the data will be imported.

Key Path	Recall, Data
<b>Remote Command</b>	:MMEMory:LOAD:LIMit LLINE1   LLINE2   LLINE3   LLINE4   LLINE5   LLINE6,<filename>
<b>Example</b>	:MMEM:LOAD:LIM LLINE2, "myLimitLine2.csv" imports the 2nd Limit Line from the file myLimitLine2.csv in the current path. The default path is depending on the Limit Default Directory selection.
Dependencies	Errors are reported if the file is empty or missing, or if the file type does not match, or if there is a mismatch between the file type and the destination data type. If any of these occur during manual operation, the analyzer returns to the Import Data menu and the File Open dialog goes away. This key will only appear if you have the proper option installed in your instrument.
Couplings	When a limit line is loaded from mass storage, it is automatically turned on. This allows you to see it, thus confirming the load. The Margin settings will match those set when the limit was saved
Readback	1 2 3 4 5 6
Status Bits/OPC dependencies	Sequential - aborts the current measurement
Initial S/W Revision	A.02.00

### Default Directory

Specifies the default directory used for loading of Limit. If user is selected, the default recall directory is the default (My Documents\EMI\data\xxx\Limits where xxx is the measurement name) or the last directory you saved the limit line data to. Otherwise, the default recall directory is My Documents\EMC Limits and Ampcor\Limits, which contains a set of preloaded limit files.

Key Path	Recall, Export Data, Limit
<b>Remote Command</b>	:MMEMory:LOAD:LIMit:DDIRectory USER PRELoaded
<b>Example</b>	:MMEM:LOAD:LIM:DDIR USER Select user :MMEM:LOAD:LIM:DDIR?
Notes	USER = User PRELoaded = Preloaded
Preset	PRELoaded

State Saved	Saved in instrument state.
Range	User  Preloaded
Readback	"User"  "Preloaded"
Initial S/W Revision	A.13.00

## Open

Most of the functions under this key work the same way in many measurements. For details about this key, see "[Open...](#)" on page 1089.

## Restart

The Restart function restarts the current sweep, or measurement, or set of averaged/held sweeps or measurements. If you are Paused, pressing Restart does a Resume.

The Restart function is accessed in several ways:

- Pressing the Restart key
- Sending the remote command INIT:IMMEDIATE
- Sending the remote command INIT:RESTART

See "[More Information](#)" on page 680

Key Path	Front-panel key
Remote Command	:INITiate[:IMMEDIATE] :INITiate:RESTART
Example	:INIT:IMM :INIT:REST
Notes	:INITiate:RESTART and :INITiate:IMMEDIATE perform exactly the same function.
Couplings	Resets average/hold count k. For the first sweep overwrites all active (update=on) traces with new current data. For application modes, it resets other parameters as required by the measurement.
Status Bits/OPC dependencies	This is an Overlapped command. The STATus:OPERation register bits 0 through 8 are cleared. The STATus:QUESTionable register bit 9 (INTegrity sum) is cleared. The SWEEPING bit is set. The MEASURING bit is set.
Backwards Compatibility Notes	For Spectrum Analysis mode in ESA and PSA, the Restart hardkey and the INITiate:RESTART command restart trace averages (displayed average count reset to 1) for a trace in Clear Write, but did not restart Max Hold and Min Hold.  In the X-Series, the Restart hardkey and the INITiate:RESTART command restart not only Trace Average, but MaxHold and MinHold traces as well.  For wireless comms modes in ESA and PSA, the Restart hardkey and the INITiate:RESTART command restart every measurement, which includes all traces and numeric results. There is no change to this operation.
Initial S/W Revision	Prior to A.02.00

### More Information

The **Restart** function first aborts the current sweep/measurement as quickly as possible. It then resets the sweep and trigger systems, sets up the measurement and initiates a new data measurement sequence with a new data acquisition (sweep) taken once the trigger condition is met.

If the analyzer is in the process of aligning when **Restart** is executed, the alignment finishes before the restart function is performed.



Even when set for Single operation, multiple sweeps may be taken when Restart is pressed (for example, when averaging/holding is on). Thus when we say that **Restart** "restarts a measurement," we may mean:

- It restarts the current sweep
- It restarts the current measurement
- It restarts the current set of sweeps if any trace is in Trace Average, Max Hold or Min Hold
- It restarts the current set of measurements if Averaging, or Max Hold, or Min Hold is on for the measurement
- depending on the current settings.

With **Average/Hold Number** (in **Meas Setup** menu) set to 1, or Averaging off, or no trace in Trace Average or Hold, a single sweep is equivalent to a single measurement. A single sweep is taken after the trigger condition is met; and the analyzer stops sweeping once that sweep has completed. However, with **Average/Hold Number** >1 and at least one trace set to **Trace Average, Max Hold, or Min Hold (SA Measurement)** or **Averaging on (most other measurements)**, multiple sweeps/data acquisitions are taken for a single measurement. The trigger condition must be met prior to each sweep. The sweep is stopped when the average count  $k$  equals the number  $N$  set for **Average/Hold Number**. A measurement average usually applies to all traces, marker results, and numeric results; but sometimes it only applies to the numeric results.

Once the full set of sweeps has been taken, the analyzer will go to idle state. To take one more sweep without resetting the average count, increment the average count by 1, by pressing the step up key while **Average/Hold Number** is the active function, or sending the remote command `CALC:AVER:TCON UP`.

## Save

The Save menu lets you choose what you want to save and where you want to save it. Among the types of files you can save are **States**, **Traces**, and **Screen Images**. In addition, an Export (Data) option lets you save a number of data types as CSV files for easy import into Excel and other spreadsheet programs.

Key Path	Front-panel key
Mode	All
Notes	No remote command for this key specifically, but the :MMEM:STORe command is available for specific file types. An example is :MMEM:STOR:STATe <filename>.
Initial S/W Revision	Prior to A.02.00

## State

The Save State menu lets you choose a register or file for saving the state.

The content of a state file includes all of the settings and data required to return the analyzer as closely as possible to the Mode it was in, with the exact settings which were in place, when the save occurred. The Mode settings in each state file include the settings that are affected by Mode Preset, as well as the additional settings affected by Restore Mode Defaults; all of the Mode's settings. In addition, all of the settings of the Input/Output system are included, even though they are outside of the Mode's state, because they are needed to restore the complete setup. Persistent System settings (for example, Verbose SCPI) are not affected by either Mode Preset or Restore Mode Defaults, nor are they included in a saved State file.

After the save completes, the message "File <filename> saved" or "State Register <register number> saved" is displayed.

For rapid saving, the State menu lists 16 registers to save to. Pressing a Register key initiates the save. You can also select a file to save to.

The default path for all State Files is:

My Documents\<<mode name>\state

where <mode name> is the parameter used to select the mode with the INST:SEL command (for example, SA for the Spectrum Analyzer).

Key Path	Save
Mode	All
Remote Command	:MMEMory:STORe:STATe <filename>
Example	MMEM:STOR:STATe "MyStateFile.state" This stores the current instrument state data in the file MyStateFile.state in the default directory.
Notes	Both single and double quotes are supported for any filename parameter over remote. After saving to a register, that register's menu key is updated with the date the time, unless a custom label has been entered for that key. After saving to a register, you remain in the Save State menu, so that you can see the Register key

update. After saving to a file, the analyzer automatically returns to the previous menu and any Save As dialog goes away.

<b>Backwards Compatibility SCPI</b>	:MMEMory:STORe:STATe 1,<filename>
Initial S/W Revision	Prior to A.02.00

### To File . . .

When you press “To File”, the analyzer brings up a Windows dialog and a menu entitled “**Save As.**” This menu allows you to navigate to the various fields in the Windows dialog without using a keyboard or mouse. The Tab and Arrow keys can also be used for dialog navigation.

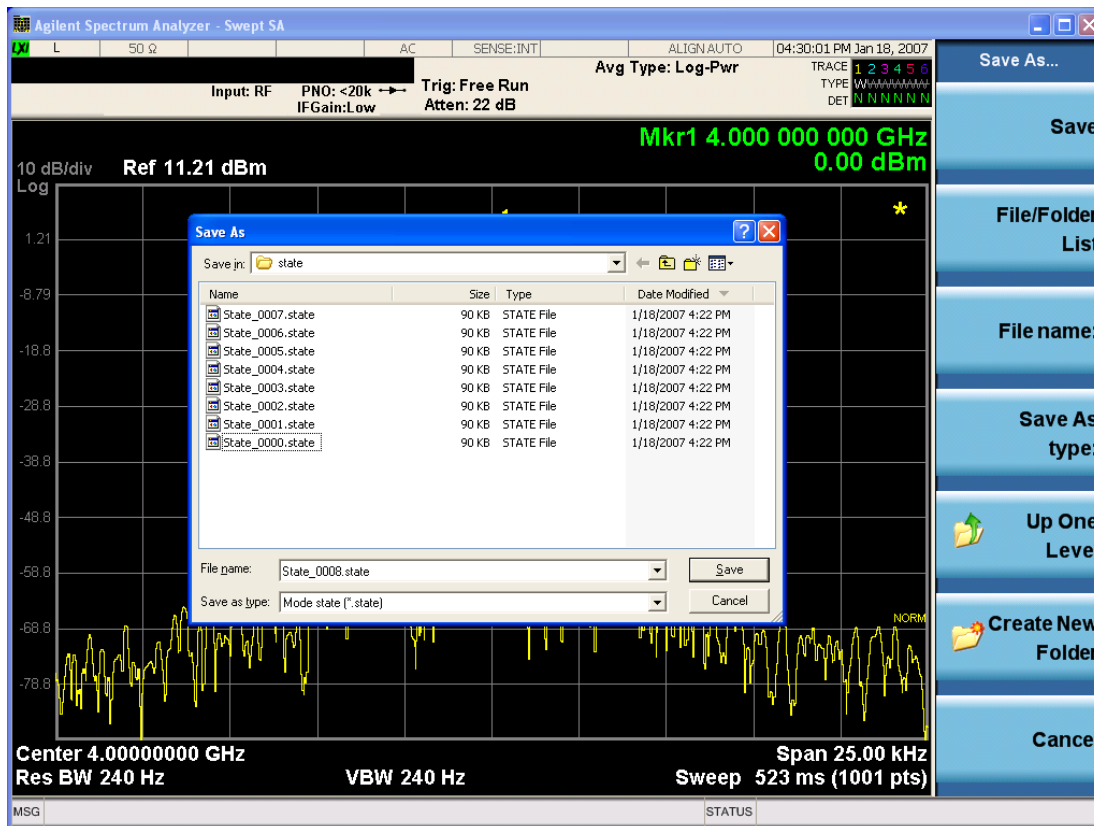

The Listed below

are the functions of the various fields in the dialog, and the corresponding softkeys:

#### Save

Performs the save to the specified file of the selected type. If the file already exists, a dialog will appear that allows you to replace the existing file by selecting OK, or you can Cancel the request. If you select OK, the file will be overwritten. Using the C: drive is strongly discouraged, since it runs the risk of being overwritten during an instrument software upgrade.

While the save is being performed, the floppy icon appears briefly in the Meas bar.

### File/Folder List

Enables you to navigate to the center of the dialog that contains the list of files and folders. Once here you can get information about the file and use the tab keys to navigate to the other fields in the dialog, such as Save In.

### Save In

The Save In field shows the path to which the file will be saved and allows you to change the path using the up and down arrow keys to navigate to other paths; the Enter key to open a directory; and the Backspace key to go back one directory. The **Save In field** defaults to the default path for this type of file and remembers the last path you used to save this type of file. There is no softkey for directly navigating to the Save In field but you can use left tab to get here from the File/Folder List.

User specified paths are remembered when you leave and return to a Mode and are reset back to the default using Restore Mode Defaults.

### File Name

The File Name field is initially loaded with an automatically generated filename specific to the appropriate Save Type. The automatically generated filename is guaranteed not to conflict with any filename currently in the directory. You may replace or modify this filename using the File Name key. See the ["Quick Save " on page 1079](#) documentation for more on the automatic file naming algorithm.

When you press the File Name key the analyzer displays the Alpha Editor. Use the knob to choose the letter to add and the front-panel Enter key to add the letter to the file name. The BK character moves you back and the FW character moves you forward in the filename. The Select key on the front panel generates a space character. When you are done entering the filename press the Done softkey. This returns back to the **File Open** dialog and menu, but does not cause the save to occur.

### Save As Type

This field shows the file suffix for the type of file you have selected to save. For example, if you navigated here while saving State, "Mode state (\*.state)" is in the field. If you navigated here from saving Trace, ""Mode state (\*.trace)" is in the field. If you navigated here while exporting a trace data file, "Trace Data (\*.csv)" is in the field. For some file types, there is more than one choice in the dropdown, which you can select by using the up and down arrow keys and Enter.

### Up One Level

This key corresponds to the icon of a folder with the up arrow that is in the tool bar of the dialog. When pressed, it causes the file and folder list to navigate up one level in the directory structure. The Backspace key does the same thing.

### Create New Folder

This key corresponds to the icon of a folder with the "\*" that is in the tool bar of the dialog. When pressed, a new folder is created in the current directory with the name **New Folder** and you can enter a new folder name using the Alpha Editor.

### Cancel

This key corresponds to the Cancel selection in the dialog. It causes the current **Save As** request to be cancelled. The ESC key does the same thing.

Key Path	Save, State
Mode	All
Notes	Brings up Save As dialog for saving a State Save Type
Initial S/W Revision	Prior to A.02.00

## Edit Register Names

You may enter a custom name on any of the Register keys, to help you remember what you are using that state to save. To do this, press the Edit Register Names key, choose the register whose name you wish to edit, and then enter the desired label using the Alpha Editor or an external PC keyboard.

The maximum number of characters that can be added is 30. In most cases, 30 characters will fit on two lines of the key.

See "[More Information](#)" on page 685

Key Path	Save, State
Mode	All
<b>Remote Command</b>	:MMEMory:REGister:STATe:LABel <reg number>,"label" :MMEMory:REGister:STATe:LABel? <reg number>
<b>Example</b>	:MMEM:REG:STAT:LAB 1,"my label"
Notes	<reg number> is an integer from 1 to 16. If the SCPI specifies an invalid register number an error message is generated, -222,"Data out of range;Invalid register label number" "label" is a string from 0 to 30 characters in length. If a label exceeds 30 characters, an error message is generated, -150,"String data error;Label clipped to 30 characters" "label" of length 0 erases the custom label and restores the default (time and date) label. E.g.: :MMEM:REG:STAT:LAB 1,""
Dependencies	N9060A-7FP or N9060B-2FP license required to edit the register names. When the feature is not licensed, sending this command generates an error, -221,"Settings conflict;Option not available"
Preset	The names are unaffected by Preset or power cycle but are set to the default label (time and date) on a "Restore System Defaults->Misc"
Initial S/W Revision	A.11.00

## More Information

When you edit one of the register names, the time and date field will be replaced by the custom name.

If you delete all the characters in the custom name, it restores the default (time and date).

The register names are stored within the state files, but they are not part of the instrument state; that is, once you have edited a register name, loading a new state will not change that register name. Another consequence of this is that the names will be persistent through a power cycle. Also, if a named state file is transferred to another analyzer, it will bring its custom name along with it.

If you try to edit the name of an empty register, the analyzer will first save the state to have a file to put the name in. If you load a named state file into an analyzer with older firmware it will ignore the metadata.

The \*SAV and \*RCL commands will not be affected by the custom register names, nor will the MMEM commands.

### Register 1 thru Register 16

Selecting any one of these register menu keys causes the State of the currently active mode to be saved to the specified Register. The registers are provided for rapid saving and recalling, since you do not need to specify a filename or navigate to a file. Each of the register menu keys annotates whether it is empty or at what date and time it was last modified. In addition, you can use the Edit Register Names key to enter custom names for each register.

Although these 16 registers are the only registers available from the front panel, there are 128 state registers available in the instrument. Registers 17–128 are only available from the SCPI interface, using the \*SAV command.

There is one set of 128 state registers in the instrument, not one set for each Mode. When a state is saved, the Mode it was saved from is saved with it; then when it is recalled, the instrument switches to that Mode.

After the save completes, the corresponding register menu key annotation is updated with the date and time and the message "Register <register number> saved" is displayed.

Key Path	Save, State
Mode	All
<b>Example</b>	*SAV 1
Range	1–16 from front panel, 1–128 from SCPI
Readback	Date and time with seconds resolution are displayed on the key OR A custom name of up to 30 characters entered using the Edit Register Names key OR “(empty)” if no prior save operation has been performed to this register.
Initial S/W Revision	Prior to A.02.00
Modified at S/W Revision	A.11.00

### Register 1 thru Register 16

Selecting any one of these register menu keys causes the State of the currently active mode to be saved to the specified Register. The registers are provided for rapid saving and recalling, since you do not need to specify a filename or navigate to a file. Each of the register menu keys annotates whether it is empty or at what date and time it was last modified. In addition, you can use the Edit Register Names key to enter custom names for each register.

Although these 16 registers are the only registers available from the front panel, there are 128 state registers available in the instrument. Registers 17–128 are only available from the SCPI interface, using the \*SAV command.

There is one set of 128 state registers in the instrument, not one set for each Mode. When a state is saved, the Mode it was saved from is saved with it; then when it is recalled, the instrument switches to that Mode.

After the save completes, the corresponding register menu key annotation is updated with the date and time and the message "Register <register number> saved" is displayed.

Key Path	Save, State
Mode	All
<b>Example</b>	*SAV 1
Range	1–16 from front panel, 1–128 from SCPI
Readback	Date and time with seconds resolution are displayed on the key OR A custom name of up to 30 characters entered using the Edit Register Names key OR “(empty)” if no prior save operation has been performed to this register.
Initial S/W Revision	Prior to A.02.00
Modified at S/W Revision	A.11.00

### Save As . . .

When you press “Save As”, the analyzer brings up a Windows dialog and a menu entitled “**Save As.**” This menu allows you to navigate to the various fields in the Windows dialog without using a keyboard or mouse. The Tab and Arrow keys can also be used for dialog navigation.

See "[To File . . .](#)" on page 1096 in Save, State for a full description of this dialog and menu.

The default path for saving files is:

For all of the Trace Data Files:

My Documents\<>mode name>\data\traces

For all of the Limit Data Files:

My Documents\<>mode name>\data\limits

For all of the Measurement Results Data Files:

My Documents\<>mode name>\data\<>measurement name>\results

For all of the Capture Buffer Data Files:

My Documents\<>mode name>\data\captureBuffer

Key Path	Save, Data
Mode	All
Notes	The key location is mode-dependent and will vary. Brings up the Save As dialog for saving a <mode specific> Save Type. The save is performed immediately and does not wait until the measurement is complete.
Initial S/W Revision	Prior to A.02.00

## Data (Export)

Exporting a data file stores data from the current measurement to mass storage files. The Export Menu only contains data types that are supported by the current measurement.

Since the commonly exported data files are in .csv format, the data can be edited by you prior to importing. This allows you to export a data file, manipulate the data in Excel (the most common PC Application for manipulating .csv files) and then import it.

Selecting an Export Data menu key will not actually cause the exporting to occur, since the analyzer still needs to know where you wish to save the data. Pressing the Save As key in this menu brings up the Save As dialog and Save As menu that allows you to specify the destination file and directory. Once a filename has been selected or entered in the Open menu, the export will occur as soon as the Save key is pressed.

Key Path	Save
Mode	All
Notes	The menu is built from whatever data types are available for the mode. So the key locations in the sub menu will vary. No SCPI command directly controls the Data Type that this key controls. The Data Type is included in the MMEM:STORe commands.
Dependencies	If a file type is not used by a certain measurement, that type is grayed out for that measurement. The key for a file type will not show at all if there are no measurements in the Mode that support it.
Preset	Is not affected by a Preset or shutdown, but is reset during Restore Mode Defaults
Readback	The data type that is currently selected
Initial S/W Revision	Prior to A.02.00

## Amplitude Correction

Pressing this key selects **Amplitude Corrections** as the data type to be exported. Pressing this key again brings up the Select Menu, which allows the user to select which **Amplitude Correction** to save.

Amplitude Corrections are fully discussed in the documentation of the Input/Output key, under the Corrections softkey.

See ["Correction Data File " on page 689](#)

Key Path	Save
Remote Command	:MMEMory:STORe:CORRection 1 2 3 4 5 6, <filename>
Example	:MMEM:STOR:CORR 2 "myAmpcor.csv" saves Correction 2 to the file myAmpcor.csv on the current path. The default path is My Documents\amplitudeCorrections.
Notes	If the save is initiated via SCPI, and the file already exists, the file will be overwritten. Using the C: drive is strongly discouraged, since it runs the risk of being overwritten during an instrument software upgrade. Both single and double quotes are supported for any filename parameter over SCPI.



Dependencies	Corrections are not supported by all Measurements. If in a Mode in which some Measurements support it, this key will be grayed out in measurements that do not. The key will not show at all if no measurements in the Mode support it.  This key will not appear unless you have the proper option installed in your instrument.
Readback	Selected Correction
<b>Backwards Compatibility SCPI</b>	:MMEMory:STORe:CORRection ANTenna   CABLE   OTHer   USER, <filename>  For backwards compatibility, ANTenna maps to 1, CABLE maps to 2, OTHer maps to 3 and USER maps to 4
Initial S/W Revision	A.02.00

### Correction Data File

A Corrections Data File contains a copy of one of the analyzer correction tables. Corrections provide a way to adjust the trace display for predetermined gain curves (such as for cable loss).

Corrections files are text files in .csv (comma separated values) form, to make them importable into Excel or other spreadsheet programs. The format for Corrections files is as follows.

Line #	Type of field	Example	Notes
1	File type, must be "Amplitude Correction"	Amplitude Correction	May not be omitted
2	File Description (in quotes)	"Correction Factors for 11966E"	60 characters max; may be empty but may not be omitted. If exceeds 60 characters, error -233 Too much data reported
3	Comment (in quotes)	"Class B Radiated"	60 characters max; may be empty but may not be omitted. . If exceeds 60 characters, error -233 Too much data reported
4	Instrument Version, Model #	A.02.06,N9020A	May be empty but may not be omitted
5	Option List, File Format Version	K03 LFE EXM ,01	May be empty but may not be omitted
6	Freq Unit to be used for all frequency values in the file	Frequency Unit,MHz	assumed to be Hz if omitted
7	Antenna Unit	Antenna Unit,None	If omitted leaves the Antenna unit unchanged. The amplitude unit in the Antenna Unit field is a conversion factor that is used to adjust the Y Axis Units of the current mode, if the mode supports Antenna Units. For more details on antenna correction data, refer to the Input/Output,Corrections key description. Allowable values: dBuv/m, dBuA/m, dBG, dBpT, None

Line #	Type of field	Example	Notes
8	Freq Interpolation	Frequency Interpolation,Linear	if omitted leaves the Freq Interpolation unchanged. Allowable values: Linear, Logarithmic
9	Bias value in mA	Bias,0.00	If omitted leaves the Bias value unchanged (added as of A.08.50)
10	Bias State	Bias State,On	If omitted leaves the Bias State unchanged. Allowable values: On, Off (added as of A.08.50)
11	Overlap, two values, Freq1 and Freq2, separated by commas.	Overlap,33500,40000	Uses Freq Unit from line 6. Thus, in this example Freq1=33.5 GHz, Freq2= 40.0 GHz (see note below). If omitted leaves the overlap unchanged (added as of A.08.50)
12	DATA marker	DATA	Corrections data begins in the next line

Lines 2 through 5 can be empty but must appear in the file. Lines 6 through 11 are optional, the lines can be left out of the file altogether.

The Overlap row and the two Bias rows apply only to external mixing. Both are read-only, they are never written by the analyzer. The only way to insert or modify these rows is to edit the file with a text editor or a spreadsheet editor. These rows are intended for use by mixer manufacturers, as they allow the manufacturer to insert data about how the mixer corrections were generated and how they should be applied. The Bias rows allow you to specify whether to turn Bias on or off when the Correction is turned on and to specify a Bias value (turning off the Correction does not change the Bias, but turning it back on again sets it to the value specified in the file). The Overlap row allows you to specify an overlap region in which two different corrections may be applied. It is expected that in the corrections data itself, there will be TWO corrections values exactly at Max Freq, otherwise Overlap is ignored. The way the overlap is processed is as follows: if at any given time the current analyzer Start Freq is greater than Freq 1 and lower than Freq 2, and the current Stop Freq is greater than Freq 2, extend the first correction point at or above Freq 2 down to Freq 1, rather than using the correction data between Freq1 and Freq2.

The Antenna Unit row can only be used in Correction register 1, because there can only be one setting for Antenna Unit at any given time. If a Correction whose Antenna Unit is set to anything but None is loaded into any Correction register but 1, an error is generated (Mass storage error; Can only load an Antenna Unit into Correction 1). When a correction file is saved from any Correction register but 1, Antenna Unit is always written as None.

Similarly, the Bias rows can only be used in Correction register 1, because there can only be one setting for Bias at any given time. If a Correction file with a Bias or Bias State row is loaded into any Correction register but 1, an error is generated: Mass storage error; Can only load Bias Settings into Correction 1

The data follows the DATA row, as comma separated X, Y pairs; one pair per line.

For example, suppose you have an Antenna to correct for on an N9020A version A.02.06 and the correction data is:

- 0 dB at 200 MHz

- 17 dB at 210 MHz
- 14.8 dB at 225 MHz

Then the file will look like:

- Amplitude Correction
- "Correction Factors for 11966E"
- "Class B Radiated"
- A.02.06,N9020A
- P13 EA3 UK6,01
- Frequency Unit,MHz
- Antenna Unit,dBuV/m
- Frequency Interpolation,Linear
- DATA
- 200.000000,0.00
- 210.000000,17.00
- 225.000000,14.80

The choices for the 1 of N fields in the metadata are as follows:

- Frequency Unit: Hz, kHz, MHz, GHz
- Antenna Unit: dBuv/m, dBuA/m, dBG, dBpT, None
- Frequency Interpolation: Logarithmic, Linear

## Trace

Pressing this key selects Traces as the data type to be exported. Pressing this key when it is already selected brings up the Trace Menu, which allows you to select which Trace to save.

The trace file contains “meta” data which describes the current setting of the analyzer, but it is not eh full state of the analyzer. The trace file content is detailed in:

["Frequency Scan Trace File Content" on page 692](#)

["Strip Chart Trace File Content" on page 693](#)

["Monitor Spectrum Trace File Content" on page 694](#)

Key Path	Save, Data
<b>Remote Command</b>	:MMEMory:STORe:TRACe:DATA TRACE1   TRACE2   TRACE3   ALL,<filename>
<b>Example</b>	:MMEM:STOR:TRAC:DATA TRACE2, "myTrace2.csv" exports the 2nd trace to the file myTrace2.csv in the current path. The default path is My Documents\EMI\data\xxx\Traces where xxx is the measurement name.
<b>Notes</b>	If the save is initiated via SCPI, and the file already exists, the file will be overwritten.

	Using the C: drive is strongly discouraged, since it runs the risk of being overwritten during an instrument software upgrade. Both single and double quotes are supported for any filename parameter over SCPI.
Dependencies	Traces cannot be recalled from a trace file that was saved with ALL traces selected.
Readback	1 2 3 All
Status Bits/OPC dependencies	Sequential - waits for previous measurement to complete
Initial S/W Revision	Prior to A.02.00

### Frequency Scan Trace File Content

The following file example shows the Trace file content in Excel for one trace.

Trace	
EMI:FSCAN	
A.07.00	N9020A
526 EA3 B25 P26 PFR	1
Preselector	
	On
Scan Type	
	Smooth
Number of scans	
	1
Y Axis Unit	
	dBuV
Ref Level Offset	
	0 dB
Coupling	
	AC
Input Z Correction	
	50 ohm
Data	
Trace	1
Detector	
	Peak
30000000	-91.67179747
30060002.47	-91.73843172
30120004.95	-88.07746798
30180007.42	-90.05428387
30240009.9	-86.55925246
30300012.37	-87.6724363
30360014.85	-93.18478677
30420017.32	-95.06361113
30480019.79	-91.02766645

30540022.27	-90.66836416
30600024.74	-87.10931161

### Strip Chart Trace File Content

The following file example shows the Trace file content in Excel.

AllTrace			
EMI:Schart			
A.07.00_R0009	N9020A		
526 EA3 B25 P26 PFR	1		
Frequency	600000000		
Freq Offset	0		
Attenuation	10		
Y Axis Unit	dBuV		
Ref Level Offset	0		
Internal Preamp State	Off		
Internal Preamp Band	Low		
Resolution Bandwidth	120000		
Dwell Time	0.05		
Peak Hold	Infinite		
Peak Hold Time	2		
Max Duration	500		
Data			
Trace	1	2	3
Detector	Peak	QuasiPeak	EmiAverage
Max	25.4396633	20.242876	12.356569
0	23.7515958	20.173686	12.282337
-0.05	24.6648769	20.194918	12.262222
-0.1	23.3178199	20.213507	12.253423
-0.15	23.5216423	20.221337	12.258119
-0.2	23.4602343	20.220859	12.262763
-0.25	23.5765176	20.212508	12.297994
-0.3	23.7032533	20.197088	12.325791
-0.35	24.825583	20.185434	12.332104

-0.4	23.6549108	20.186032	12.352822
-0.45	23.1558073	20.184001	12.356569
-0.5	23.8378283	20.171481	12.352344
-0.55	24.0481835	20.148553	12.329247
-0.6	23.7659679	20.165786	12.308906
-0.65	23.6379256	20.191835	12.330754
-0.7	23.1793252	20.20728	12.316628
-0.75	23.7241582	20.208026	12.324215
-0.8	24.0573294	20.205218	12.343919

### Monitor Spectrum Trace File Content

The following file example shows the Trace file content in Excel.

Trace	
EMI:MON	
A.13.00	N9038A
526 DP2 EMC LSN	1
Preselector	On
Y Axis Unit	dBuV
Ref Level Offset	0 dB
Coupling	AC
Input Z Correction	50 ohm
DATA	
Trace	1
Detector	Peak
29740009.9	9.302139008
29741009.9	9.609657014
29742009.9	9.945373261
29743009.9	10.28534671
29744009.9	10.59982272
29745009.9	10.84645816
29746009.9	10.97216769
29747009.9	10.93370792
29748009.9	10.70057651

29749009.9	10.21771213
29750009.9	9.474250519
29751009.9	8.374183381
29752009.9	6.909049714
29753009.9	4.86714145
29754009.9	2.253837311
29755009.9	-0.937874114
29756009.9	-4.154472625

### Save As . . .

When you press “Save As”, the analyzer brings up a Windows dialog and a menu entitled “**Save As.**” This menu allows you to navigate to the various fields in the Windows dialog without using a keyboard or mouse. The Tab and Arrow keys can also be used for dialog navigation.

See ["To File . . ." on page 1096](#) in Save, State for a full description of this dialog and menu.

The default path for saving files is:

For all of the Trace Data Files:

My Documents\`<mode name>`\data\traces

For all of the Limit Data Files:

My Documents\`<mode name>`\data\limits

For all of the Measurement Results Data Files:

My Documents\`<mode name>`\data\`<measurement name>`\results

For all of the Capture Buffer Data Files:

My Documents\`<mode name>`\data\captureBuffer

Key Path	Save, Data
Mode	All
Notes	The key location is mode-dependent and will vary. Brings up the Save As dialog for saving a <code>&lt;mode specific&gt;</code> Save Type. The save is performed immediately and does not wait until the measurement is complete.
Initial S/W Revision	Prior to A.02.00

### Screen Image

Pressing Screen Image accesses a menu of functions that enable you to specify a format and location for the saved screen image. It brings up a menu that allows you to specify the color scheme of the Screen Image (Themes) or navigate to the Save As dialog to perform the actual save.

9 Strip Chart Measurement  
Save

Screen Image files contain an exact representation of the analyzer display. They cannot be loaded back onto the analyzer, but they can be loaded into your PC for use in many popular applications.

The image to be saved is actually captured when the Save front panel key is pressed, and kept in temporary storage to be used if you ask for a Screen Image save. When the Screen Image key is pressed, a "thumbnail" of the captured image is displayed, as shown below:

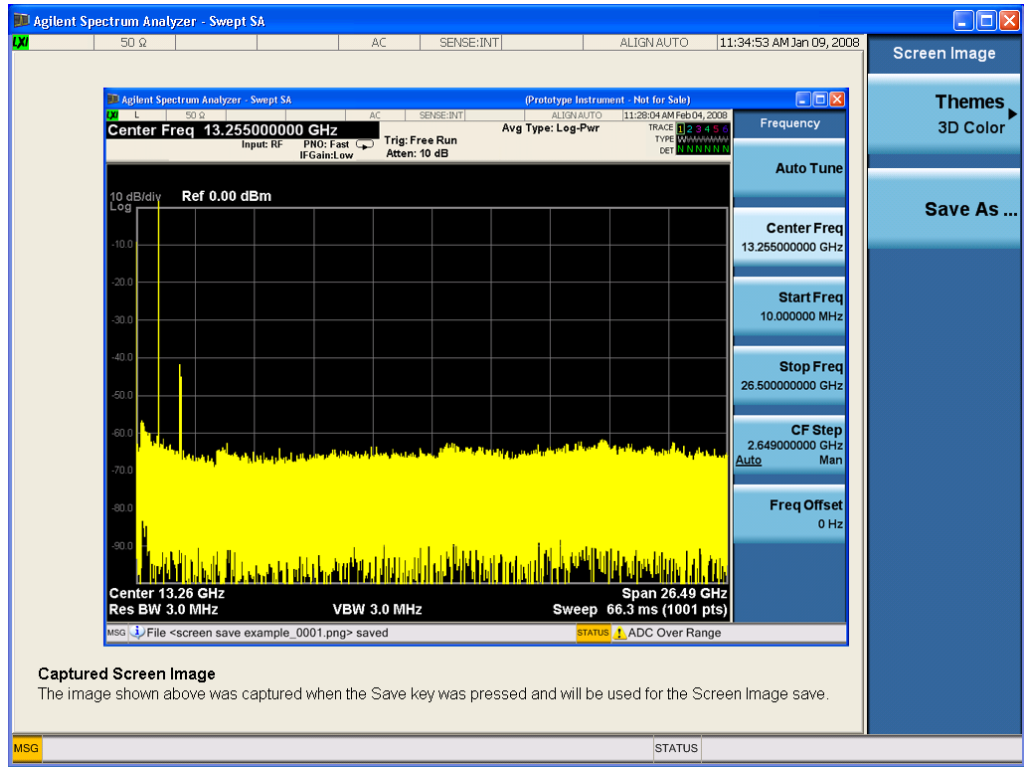

When you continue on into the Save As menu and complete the Screen Image save, the image depicted in the thumbnail is the one that gets saved, showing the menus that were on the screen before going into the Save menus. The save is performed immediately and does not wait until the measurement is complete.

After you have completed the save, the Quick Save front-panel key lets you quickly repeat the last save performed, using an auto-named file, with the current screen data.

**NOTE** For versions previous to A.01.55, if you initiate a screen image save by navigating through the Save menus, the image that is saved will contain the Save menu softkeys, not the menus and the active function that were on the screen when you first pressed the Save front panel key.

Key Path	Save
Mode	All
Remote Command	:MMEMory:STORe:SCReen <filename>
Example	:MMEM:STOR:SCR "myScreen.png" This stores the current screen image in the file MyScreenFile.png in the default directory.
Initial S/W Revision	Prior to A.02.00



## Themes

Accesses a menu of functions that enable you to choose the theme to be used when saving the screen image.

The **Themes** option is the same as the **Themes** option under the **Display** and **Page Setup** dialogs. It allows you to choose between themes to be used when saving the screen image.

<b>Key Path</b>	Save, Screen Image
<b>Remote Command</b>	:MMEMory:STORe:SCReen:THEMe TDColor   TDMonochrome   FCOlor   FMONochrome  :MMEMory:STORe:SCReen:THEMe?
<b>Example</b>	:MMEM:STOR:SCR:THEM TDM
<b>Preset</b>	3D Color; Is not part of Preset, but is reset by Restore Misc Defaults or Restore System Defaults All and survives subsequent running of the modes.
<b>Readback</b>	3D Color   3D Mono   Flat Color   Flat Mono
<b>Backwards Compatibility Notes</b>	In ESA and PSA we offer the choice of "Reverse Bitmap" or "Reverse Metafile" when saving screen images. This is much like the "Flat Color" theme available in X-Series. Also, if you selected Reverse Bitmap AND a black & white screen image, that would be much like "Flat Monochrome". In other words, each of the X-Series themes has a similar screen image type in ESA/PSA. But they are not identical.
<b>Initial S/W Revision</b>	Prior to A.02.00

### 3D Color

Selects a standard color theme with each object filled, shaded and colored as designed.

<b>Key Path</b>	Save, Screen Image, Themes
<b>Example</b>	MMEM:STOR:SCR:THEM TDC
<b>Readback</b>	3D Color
<b>Initial S/W Revision</b>	Prior to A.02.00

### 3D Monochrome

Selects a format that is like 3D color but shades of gray are used instead of colors.

<b>Key Path</b>	Save, Screen Image, Themes
<b>Example</b>	MMEM:STOR:SCR:THEM TDM
<b>Readback</b>	3D Mono
<b>Initial S/W Revision</b>	Prior to A.02.00

### Flat Color

Selects a format that is best when the screen is to be printed on an ink printer.

Key Path	Save, Screen Image, Themes
<b>Example</b>	MMEM:STOR:SCR:THEM FCOL
Readback	Flat Color
Initial S/W Revision	Prior to A.02.00

### Flat Monochrome

Selects a format that is like Flat Color. But only black is used (no colors, not even gray), and no fill.

Key Path	Save, Screen Image, Themes
<b>Example</b>	MMEM:STOR:SCR:THEM FMON
Readback	Flat Mono
Initial S/W Revision	Prior to A.02.00

### Save As...

When you press “Save As”, the analyzer brings up a Windows dialog and a menu entitled “**Save As.**” This menu allows you to navigate to the various fields in the Windows dialog without using a keyboard or mouse. The Tab and Arrow keys can also be used for dialog navigation.

See "[To File . . .](#)" on page 1096 in Save, State for a full description of this dialog and menu.

The default path for Screen Images is

My Documents\`<mode name>`\screen.

where `<mode name>` is the parameter used to select the mode with the INST:SEL command (for example, SA for the Spectrum Analyzer).

Key Path	Save, Screen Image
Notes	Brings up Save As dialog for saving a Screen Image Save Type
Initial S/W Revision	Prior to A.02.00

### Mass Storage Catalog (Remote Command Only)

Key path	SCPI Only
<b>Remote Command</b>	:MMEMory:CATalog? [ <code>&lt;directory_name&gt;</code> ]
Notes	The string must be a valid logical path. Queries disk usage information (drive capacity, free space available) and obtains a list of files and directories in a specified directory in the following format: <code>&lt;numeric_value&gt;,&lt;numeric_value&gt;,{&lt;file_entry&gt;}</code> It returns two numeric parameters and as many strings as there are files and directories. The first

---

parameter indicates the total amount of storage currently used in bytes. The second parameter indicates the total amount of storage available, also in bytes. The <file\_entry> is a string. Each <file\_entry> indicates the name, type, and size of one file in the directory list:

<file\_name>,<file\_type>,<file\_size>

As the windows file system has an extension that indicates file type, <file\_type> is always empty. <file\_size> provides the size of the file in bytes. For directories, <file\_entry> is surrounded by square brackets and both <file\_type> and <file\_size> are empty

---

Initial S/W Revision      Prior to A.02.00

---

## Mass Storage Change Directory (Remote Command Only)

---

Key path                      SCPI Only

**Remote Command**        :MMEMory:CDIRectory [<directory\_name>]  
                                  :MMEMory:CDIRectory?

**Notes**                      The string must be a valid logical path.  
  
Changes the default directory for a mass memory file system. The <directory\_name> parameter is a string. If no parameter is specified, the directory is set to the \*RST value.  
At \*RST, this value is set to the default user data storage area, that is defined as System.Environment.SpecialFolder.Personal.  
Query returns full path of the default directory.

---

Initial S/W Revision      Prior to A.02.00

---

## Mass Storage Copy (Remote Command Only)

---

Key path                      SCPI Only

**Remote Command**        :MMEMory:COPY <string>,<string> [,<string>,<string>]

**Notes**                      The string must be a valid logical path.  
  
Copies an existing file to a new file or an existing directory to a new directory.  
Two forms of parameters are allowed. The first form has two parameters. In this form, the first parameter specifies the source, and the second parameter specifies the destination.  
The second form has four parameters. In this form, the first and third parameters specify the source. The second and fourth parameters specify the directories. The first pair of parameters specifies the source. The second pair specifies the destination. An error is generated if the source doesn't exist or the destination file already exists.  
  
This command will generate an "access denied" error if the destination is a restricted folder (e.g., C:\Windows) and the current user does not have Power User or Administrator privileges.

---

## Mass Storage Device Copy (Remote Command Only)

This command transfers data to/from a file and a peripheral device.

---

Key path	SCPI Only
<b>Remote Command</b>	:MMEMory:COpy:DEvice <source_string>,<dest_string>
Notes	The strings must be a valid logical path or a valid device keyword. If the dest_string is a device keyword, the data is copied from the source file to the device. If the source_string is a device keyword, the data is copied to the source file from the device.  Valid device keywords are: SNS (smart noise source)  An error is generated if the file or device is not found.

---

### Mass Storage Delete (Remote Command Only)

---

Key path	SCPI Only
<b>Remote Command</b>	:MMEMory:DELeTe <file_name>[,<directory_name>]
Notes	The string must be a valid logical path.  Removes a file from the specified directory. The <file_name> parameter specifies the file name to be removed. This command will generate an "access denied" error if the file is in a restricted folder (e.g., C:\Windows) and the current user does not have Power User or Administrator privileges.
Initial S/W Revision	Prior to A.02.00

---

### Mass Storage Data (Remote Command Only)

Creates a file containing the specified data OR queries the data from an existing file.

---

Key path	SCPI Only
<b>Remote Command</b>	:MMEMory:DATA <file_name>, <data> :MMEMory:DATA? <file_name>
Notes	The string must be a valid logical path.  The command form is MMEMory:DATA <file_name>,<data>. It loads <data> into the file <file_name>. <data> is in 488.2 block format. <file_name> is string data.  The query form is MMEMory:DATA? <file_name> with the response being the associated <data> in block format.
Initial S/W Revision	Prior to A.02.00

---

### Mass Storage Make Directory (Remote Command Only)

---

Key path	SCPI Only
<b>Remote Command</b>	:MMEMory:MDIRectory <directory_name>
Notes	The string must be a valid logical path.  Creates a new directory. The <directory_name> parameter specifies the name to be created.

---

	This command will generate an “access denied” error if the new directory would be in a restricted folder (e.g., C:\Windows) and the current user does not have Power User or Administrator privileges.
Initial S/W Revision	Prior to A.02.00

### Mass Storage Move (Remote Command Only)

Key path	SCPI Only
<b>Remote Command</b>	:MMEMory:MOVE <string>,<string>[,<string>,<string>]
Notes	<p>The string must be a valid logical path.</p> <p>Moves an existing file to a new file or an existing directory to a new directory.</p> <p>Two forms of parameters are allowed. The first form has two parameters. In this form, the first parameter specifies the source, and the second parameter specifies the destination.</p> <p>The second form has four parameters. In this form, the first and third parameters specify the source. The second and fourth parameters specify the directories. The first pair of parameters specifies the source. The second pair specifies the destination. An error is generated if the source doesn't exist or the destination file already exists.</p> <p>This command will generate an “access denied” error if the destination is a restricted folder (e.g., C:\Windows) and the current user does not have Power User or Administrator privileges.</p>
Initial S/W Revision	Prior to A.02.00

### Mass Storage Remove Directory (Remote Command Only)

Key path	SCPI Only
<b>Remote Command</b>	:MMEMory:RDIREctory <directory_name>
Notes	<p>The string must be a valid logical path.</p> <p>Removes a directory. The &lt;directory_name&gt; parameter specifies the directory name to be removed. All files and directories under the specified directory shall also be removed.</p> <p>This command will generate an “access denied” error if the folder is a restricted folder (e.g., C:\Windows) or is in a restricted folder and the current user does not have Power User or Administrator privileges.</p>
Initial S/W Revision	Prior to A.02.00

## Single (Single Measurement/Sweep)

Sets the analyzer for Single measurement operation. The single/continuous state is Meas Global, so the setting will affect all the measurements. If you are Paused, pressing Single does a Resume.

See ["More Information" on page 702](#)

Key Path	Front-panel key
Example	:INIT:CONT OFF
Notes	See Cont key description.
Backwards Compatibility Notes	<p>For Spectrum Analysis mode in ESA and PSA, the Single hardkey and the INITiate:IMM switched from continuous measurement to single measurement and restarted sweeps and averages (displayed average count reset to 1), but did not restart Max Hold and Min Hold. In the X-Series, the Single hardkey and the INITiate:IMM command initiate a sweep/ measurement/ average sequence/hold sequence including MaxHold and MinHold.</p> <p>For Spectrum Analysis mode in ESA and PSA, the Single hardkey restarted the sweep regardless of whether or not you were in an active sweep or sweep sequence. In the X-Series, Restart does this but Single only restarts the sweep or sweep sequence if you are in the idle state.</p> <p>INIT[:IMM] in ESA &amp; PSA Spectrum Analysis Mode does an implied ABORT. In some other PSA Modes, INIT[:IMM] is ignored if not in the idle state. . The X-Series follows the ESA/PSA SA Mode model, which may cause some Modes to have compatibility problems.</p>
Initial S/W Revision	Prior to A.02.00

### More Information

See ["Restart" on page 1093](#) for details on the INIT:IMMEDIATE (Restart) function.

If you are already in single sweep, the INIT:CONT OFF command has no effect.

If you are already in Single Sweep, then pressing the Single key in the middle of a sweep does not restart the sweep or sequence. Similarly, pressing the Single key does not restart the sweep or sequence if the sweep is not in the idle state (for example, if you are taking a very slow sweep, or the analyzer is waiting for a trigger). Instead, it results in a message. "Already in Single, press Restart to initiate a new sweep or sequence". Even though pressing the Single key in the middle of a sweep does not restart the sweep, sending INIT:IMMEDIATE does reset it.

To take one more sweep without resetting the average count, increment the average count by 1, by pressing the step up key while **Average/Hold Number** is the active function, or sending the remote command CALC:AVER:TCON UP.

## Source

There is no Source control functionality for this measurement. When this key is pressed, the screen either displays a blank menu, or the previously-selected menu remains unchanged.

---

Key Path	Front-panel key
----------	-----------------

---

## SPAN X Scale

Displays the menu keys that enable you to control the span x scale parameters.

Key Path	Front-panel key
Notes	Front panel only.
Initial S/W Revision	A.07.00

### Ref Value

Sets the ref value of the strip chart display.

Key Path	SPAN X Scale
<b>Remote Command</b>	:DISPlay:Schart:VIEW[1]:WINDow[1]:TRACe:X[:SCALe]:RLEVel <time> :DISPlay:Schart:VIEW[1]:WINDow[1]:TRACe:X[:SCALe]:RLEVel?
<b>Example</b>	DISP:SCH:VIEW:WIND:TRAC:X:RLEV -100 s DISP:SCH:VIEW:WIND:TRAC:X:RLEV?
Couplings	No
Preset	0 s
State Saved	Saved in instrument state.
Min	-1.1998 ks
Max	0 s
Initial S/W Revision	A.07.00

### Scale/Div

Allows you to set X scale/div of the strip chart display.

Key Path	SPAN X Scale
<b>Remote Command</b>	:DISPlay:Schart:VIEW[1]:WINDow[1]:TRACe:X[:SCALe]:PDIVision <time> :DISPlay:Schart:VIEW[1]:WINDow[1]:TRACe:X[:SCALe]:PDIVision?
<b>Example</b>	DISP:SCH:VIEW:WIND:TRAC:X:PDIV 1s DISP:SCH:VIEW:WIND:TRAC:X:PDIV?
Preset	1 s
State Saved	Saved in instrument state.



Min	20 ms
Max	7200 s
Initial S/W Revision	A.07.00

## Strip Chart Max Duration

Sets the maximum duration for strip chart to record the data.

Key Path	SPAN X Scale
<b>Remote Command</b>	:DISPlay:Schart:VIEW[1]:WINDow[1]:TRACe:X[:SCALE]:MAX:DURation <time> :DISPlay:Schart:VIEW[1]:WINDow[1]:TRACe:X[:SCALE]:MAX:DURation?
<b>Example</b>	DISP:SCH:VIEW:WIND:TRAC:X:MAX:DUR 100 s DISP:SCH:VIEW:WIND:TRAC:X:MAX:DUR?
Couplings	No
Preset	500 s
State Saved	Saved in instrument state.
Min	200 ms
Max	1200 s
Initial S/W Revision	A.07.00

## Full Scale

Sets the Strip Chart display in full scale, this key will set Ref Value to 0s and max Scale/Div.

Key Path	SPAN X Scale
<b>Remote Command</b>	:DISPlay:Schart:VIEW[1]:WINDow[1]:TRACe:X[:SCALE]:FULL
<b>Example</b>	DISP:SCH:VIEW:WIND:TRAC:X:MAX:FULL
Initial S/W Revision	A.07.00

## Sweep/Control

Accesses a menu that enables you to stop and start the measurement.

Key Path	Front-panel key
Notes	Front panel only.
Initial S/W Revision	A.07.00

### Stop / Start

Enables you to stop a measurement. When stopped, the label on the key changes to Start. Press the Resume, Restart or Cont key to resume the measurement.

Key Path	Sweep/ Control
<b>Remote Command</b>	[ :SENSe] :SCHart:ABORt
<b>Example</b>	SCH:ABOR
Initial S/W Revision	A.07.00

Key Path	Sweep/ Control
<b>Remote Command</b>	:INITiate:IMMediate :INITiate:REStart
<b>Example</b>	INIT:IMM INIT:REST
Initial S/W Revision	A.07.00

## System

See "System" on page 272

## Trace/Detector

Displays a menu of keys that enable you to control the trace setting.

Key Path	Front-panel key
Notes	Front-panel only.
Initial S/W Revision	A.07.00

### Select Trace

Specifies the selected trace. The “selected trace” is the trace that other parameters under the Trace/Detector menu will apply to.

Key Path	Trace/ Detector
Notes	Front panel only. The selected trace is remembered even when not in the Trace/ Det Menu.
Preset	Trace 1, not affected by Mode Preset, preset by Restore Mode Defaults.
Initial S/W Revision	A.07.00

### Clear Trace

Clears the selected trace (from the front panel) or the specified trace (from SCPI).

Key Path	Trace/Detector
<b>Remote Command</b>	:TRACe:SCHart:CLEar TRACE1   TRACE2   TRACE3
<b>Example</b>	TRAC:SCH:CLE TRACE1 clears trace 1
Initial S/W Revision	A.07.00

### Clear All Traces

Clears all traces. Does not affect the state of any function or variable in the instrument.

Key Path	Trace/Detector
<b>Remote Command</b>	:TRACe:SCHart:CLEar:ALL
<b>Example</b>	TRAC:SCH:CLE:ALL clears all traces
Initial S/W Revision	A.07.00



## Trigger

See ["Trigger" on page 358](#)

### Free Run

See ["Free Run " on page 365](#)

### Video

See ["Video \(IF Envelope\) " on page 366](#)

### Trigger Level

See ["Trigger Level " on page 366](#)

### Trig Slope

See ["Trig Slope " on page 367](#)

### Trig Delay

See ["Trig Delay " on page 368](#)

### External 1

See ["External 1 " on page 369](#)

### Trigger Level

See ["Trigger Level " on page 370](#)

### Trig Slope

See ["Trig Slope " on page 370](#)

### Trig Delay

See ["Trig Delay " on page 371](#)

### Zero Span Delay Comp

See ["Zero Span Delay Comp On/Off" on page 372](#)

### External 2

See ["External 2 " on page 372](#)

### Trigger Level

See ["Trigger Level " on page 373](#)

### Trig Slope

See ["Trig Slope " on page 373](#)

### **Trig Delay**

See "Trig Delay " on page 374

### **Zero Span Delay Comp**

See "Zero Span Delay Comp On/Off" on page 374

### **Auto/Holdoff**

See "Auto/Holdoff " on page 375

### **Auto Trig**

See "Auto Trig " on page 375

### **Trig Holdoff**

See "Trig Holdoff " on page 376

## User Preset

Accesses a menu that gives you the following three choices:

- User Preset – recalls a state previously saved using the Save User Preset function.
- User Preset All Modes – presets all of the modes in the analyzer
- Save User Preset– saves the current state for the current mode

Key Path	Front-panel key
Backwards Compatibility Notes	<p>User Preset is actually loading a state, and in legacy analyzers, it was possible to load a state without affecting the trace data, limit lines or correction data. Similarly it was possible to do a User Preset without affecting the trace data, limit lines or correction data.</p> <p>In the X-Series, “state” always includes all of this data; so whenever state is loaded, or User Preset is executed, all of the traces, limit lines and corrections are affected. Although this differs from previous behavior, it is desirable behavior, and should not cause adverse issues for users.</p> <p>On ESA and PSA, User Preset affected the entire instrument’s state. In the X-Series, User Preset only recalls the state for the active mode. There is a User Preset file for each mode. User Preset can never cause a mode switch as it can in legacy analyzers. If you want to recall all modes to their user preset file state, you will need to do a User Preset after mode switching into each mode.</p> <p>User Preset recalls mode state which can now include data like traces; whereas on ESA and PSA, User Preset did not affect data.</p>
Initial S/W Revision	Prior to A.02.00

## User Preset

User Preset sets the state of the currently active mode back to the state that was previously saved for this mode using the Save User Preset menu key or the SCPI command, SYST:PRES:USER:SAV. It not only recalls the Mode Preset settings, but it also recalls all of the mode persistent settings, and the Input/Output system setting that existed at the time Save User Preset was executed.

If a Save User Preset has not been done at any time, User Preset recalls the default user preset file for the currently active mode. The default user preset files are created if, at power-on, a mode detects there is no user preset file. There will never be a scenario when there is no user preset file to restore. For each mode, the default user preset state is the same state that would be saved if a Save User Preset is performed in each mode right after doing a Restore Mode Default and after a Restore Input/Output Defaults.

The User Preset function does the following:

- Aborts the currently running measurement.
- Sets the mode State to the values defined by Save User Preset.
- Makes the saved measurement for the currently running mode the active measurement.
- Brings up the saved menu for the power-on mode.
- Clears the input and output buffers.
- Sets the Status Byte to 0.



Key Path	User Preset
<b>Remote Command</b>	:SYSTem:PRESet:USER
<b>Example</b>	:SYST:PRES:USER:SAVE:SYST:PRES:USER
Notes	:SYST:PRES:USER:SAVE is used to save the current state as the user preset state. Clears all pending OPC bits. The Status Byte is set to 0. Pressing the User Preset front-panel key while already in the User Preset menu will cause the User Preset to get executed
Couplings	A user preset will cause the currently running measurement to be aborted and cause the saved measurement to be active. Recalling a User Preset file has the same issues that recalling a Save State file has. Some settings may need to be limited and therefore re-coupled, since the capabilities of the mode may have changes when the User Preset file was last saved.
Initial S/W Revision	Prior to A.02.00

## User Preset All Modes

Recalls all of the User Preset files for each mode, switches to the power-on mode, and activates the saved measurement from the power-on mode User Preset file.

**NOTE**

When the instrument is secured, all of the user preset files are converted back to their default user preset files.

The User Preset function does the following:

- Aborts the currently running measurement.
- Switches the Mode to the power-on mode.
- Restores the User Preset files for each mode.
- Makes the saved measurement for the power-on mode the active measurement.
- Brings up the saved menu for the power-on mode.
- Clears the input and output buffers.
- Sets the Status Byte to 0.

Key Path	User Preset
<b>Remote Command</b>	:SYSTem:PRESet:USER:ALL
<b>Example</b>	:SYST:PRES:USER:SAVE:SYST:PRES:USER:ALL
Notes	Clears all pending OPC bits. The Status Byte is set to 0. :SYST:PRES:USER:SAVE is used to save the current state as the user preset state.
Couplings	A user preset will cause the currently running measurement to be aborted, cause a mode switch to the power-on mode, and cause the saved measurement to be active in the power-on mode. Recalling a User Preset file has the same issues that recalling a Save State file has. Some settings may need to be limited and therefore re-coupled, since the capabilities of the mode may have changes when the User Preset file was last saved.
Initial S/W Revision	Prior to A.02.00

## Save User Preset

Saves the currently active mode and its State. You can recall this User Preset file by pressing the User Preset menu key or sending the SYST:PRES:USER remote command. This same state is also saved by the Save State function.

Key Path	User Preset
Remote Command	:SYSTem:PRESet:USER:SAVE
Example	:SYST:PRES:USER:SAVE
Notes	:SYST:PRES:SAVE creates the same file as if the user requested a *SAV or a MMEM:STOR:STAT, except User Preset Save does not allow the user to specify the filename or the location of the file.
Initial S/W Revision	Prior to A.02.00

## View/Display

Opens the Display and View menus.

Key Path	Front-panel key
Initial S/W Revision	A.07.00

## Display

The Display menu is common to most measurements, and is used for configuring items on the display. Some Display menu settings apply to all the measurements in a mode, and some only to the current measurement. Those under the System Display Settings key apply to all measurements in all modes.

Key Path	Display
Key Path	View/Display
Initial S/W Revision	Prior to A.02.00

## Annotation

Turns on and off various parts of the display annotation. The annotation is divided up into four categories:

1. Meas Bar: This is the measurement bar at the top of the screen. It does not include the settings panel or the Active Function. Turning off the Meas Bar turns off the settings panel and the Active Function. When the Meas Bar is off, the graticule area expands to fill the area formerly occupied by the Meas Bar.
2. Screen Annotation: this is the annotation and annunciation around the graticule, including any annotation on lines (such as the display line, the threshold line, etc.) This does NOT include the marker number or the N dB result. When off, the graticule expands to fill the entire graticule area.
3. Trace annotation: these are the labels on the traces, showing their detector (or their math mode).
4. Active Function annotation: this is the active function display in the meas bar, and all of the active function values displayed on softkeys.

See the figure below. Each type of annotation can be turned on and off individually.

9 Strip Chart Measurement  
View/Display

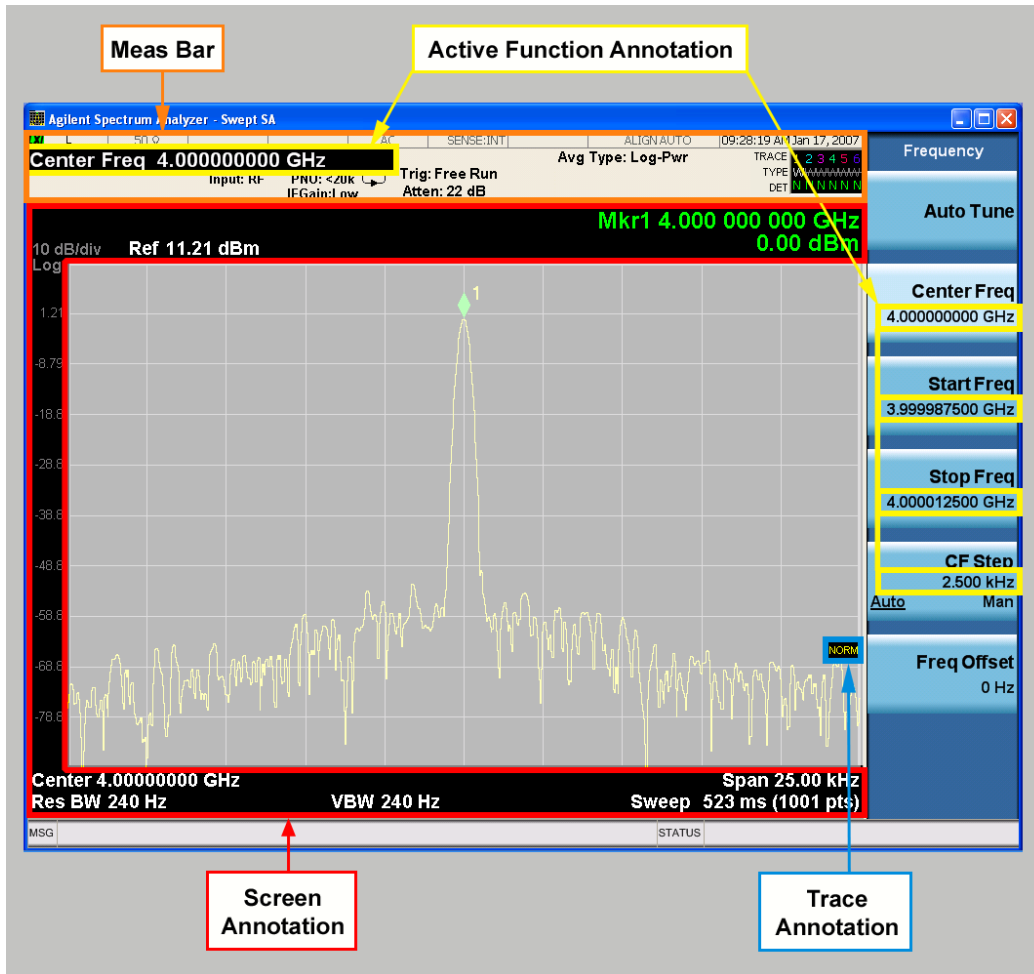

Key Path	View/Display, Display
Initial S/W Revision	Prior to A.02.00

Meas Bar On/Off

This function turns the Measurement Bar on and off, including the settings panel. When off, the graticule area expands to fill the area formerly occupied by the Measurement Bar.

Key Path	View/Display, Display, Annotation
Remote Command	:DISPlay:ANNOtation:MBAR[:STATe] OFF ON 0 1 :DISPlay:ANNOtation:MBAR[:STATe]?
Example	DISP:ANN:MBAR OFF
Dependencies	Grayed out and forced to OFF when System Display Settings, Annotation is set to Off.
Preset	On This should remain Off through a Preset when System DisplaySettings, Annotation is set to Off.
State Saved	Saved in instrument state.
Initial S/W Revision	Prior to A.02.00

## Screen

This controls the display of the annunciation and annotation around the graticule, including any annotation on lines (such as the display line, the threshold line, etc.) and the y-axis annotation. This does NOT include marker annotation (or the N dB result). When off, the graticule expands to fill the entire graticule area, leaving only the 1.5% gap above the graticule as described in the Trace/Detector chapter.

Key Path	View/Display, Display, Annotation
<b>Remote Command</b>	:DISPlay:ANNotation:SCReen[:STATe] OFF ON 0 1 :DISPlay:ANNotation:SCReen[:STATe]?
<b>Example</b>	DISP:ANN:SCR OFF
Dependencies	Grayed-out and forced to OFF when System Display Settings, Annotation is set to Off.
Preset	On This should remain Off through a Preset when System DisplaySettings, Annotation is set to Off
State Saved	Saved in instrument state.
Initial S/W Revision	Prior to A.02.00

## Trace

Turns on and off the labels on the traces, showing their detector (or their math mode) as described in the Trace/Detector section.

If trace math is being performed with a trace, then the trace math annotation will replace the detector annotation.

Key Path	View/Display, Display, Annotation
<b>Remote Command</b>	:DISPlay:ANNotation:TRACe[:STATe] ON OFF 1 0 :DISPlay:ANNotation:TRACe[:STATe]?
<b>Example</b>	DISP:ANN:TRAC OFF
Preset	Off
State Saved	Saved in instrument state.
Initial S/W Revision	Prior to A.02.00

## Active Function Values On/Off

Turns on and off the active function display in the Meas Bar, and all of the active function values displayed on the softkeys.

Note that all of the softkeys that have active functions have these numeric values blanked when this function is on. This is a security feature..

9 Strip Chart Measurement  
View/Display

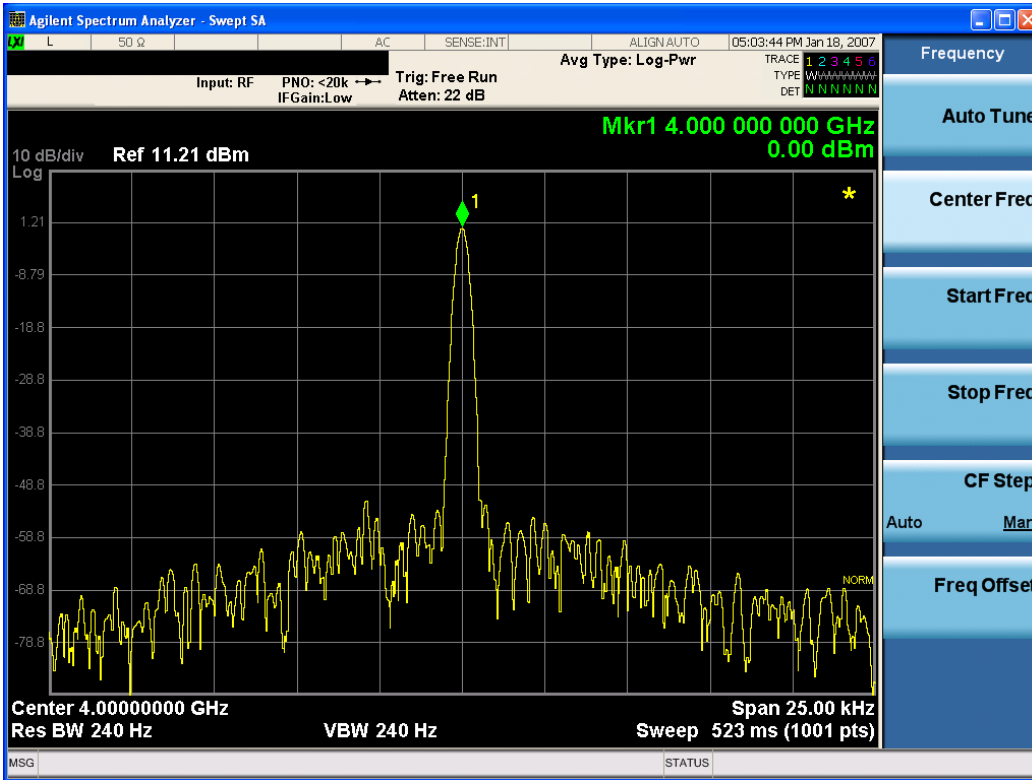

Key Path	View/Display, Display, Annotation
Remote Command	:DISPlay:ACTivefunc[:STATE] ON OFF 1 0 :DISPlay:ACTivefunc[:STATE] ?
Example	DISP:ACT OFF
Dependencies	Grayed out and forced to OFF when System Display Settings, Annotation is set to Off.
Preset	On This should remain Off through a Preset when System DisplaySettings, Annotation is set to Off
State Saved	Saved in instrument state.
Initial S/W Revision	Prior to A.02.00

Title

Displays menu keys that enable you to change or clear a title on your display.

Key Path	View/Display, Display
Initial S/W Revision	Prior to A.02.00

Change Title

Writes a title into the "measurement name" field in the banner, for example, "Swept SA".

Press Change Title to enter a new title through the alpha editor. Press Enter or Return to complete the entry. Press ESC to cancel the entry and preserve your existing title.

The display title will replace the measurement name. It remains for this measurement until you press Change Title again, or you recall a state, or a Preset is performed. A title can also be cleared by pressing Title, Clear Title.

**NOTE**

Notice the inclusion of the <measurement> parameter in the command below. Because each measurement remembers the Display Title, the command must be qualified with the measurement name. For the Swept SA measurement this is not the case; no <measurement> parameter is used when changing the Display Title for the Swept SA measurement.

Key Path	View/Display, Display, Title
Mode	All
<b>Remote Command</b>	:DISPlay:<measurement>:ANNotation:TITLe:DATA <string> :DISPlay:<measurement>:ANNotation:TITLe:DATA?
<b>Example</b>	DISP:ANN:TITL:DATA "This Is My Title" This example is for the Swept SA measurement in the Spectrum Analyzer mode. The SANalyzer <measurement> name is not used. DISP:ACP:ANN:TITL:DATA "This Is My Title" This example is for Measurements other than Swept SA. Both set the title to: This Is My Title
Notes	Pressing this key cancels any active function. When a title is edited the previous title remains intact (it is not cleared) and the cursor goes at the end so that characters can be added or BKSP can be used to go back over previous characters.
Preset	No title (measurement name instead)
State Saved	Saved in instrument state.
Initial S/W Revision	Prior to A.02.00

### Clear Title

Clears a title from the front-panel display. Once cleared, the title cannot be retrieved. After the title is cleared, the current Measurement Name replaces it in the title bar.

Key Path	View/Display, Display, Title
<b>Example</b>	The following commands clear the title and restore the measurement's original title: DISP:ANN:TITL:DATA "" This example is for the Swept SA measurement in the Spectrum Analyzer mode. The SANalyzer <measurement> name is not used. DISP:ACP:ANN:TITL:DATA "" This example is for ACP; in measurements other than Swept SA the measurement name is required.
Notes	Uses the :DISPlay:<measurement>:ANNotation:TITLe:DATA <string> command with an empty string (in the Swept SA, the <measurement> is omitted).
Preset	Performed on Preset.
Initial S/W Revision	Prior to A.02.00

## Graticule

Pressing Graticule turns the display graticule On or Off. It also turns the graticule y-axis annotation on and off.

Key Path	View/Display, Display
Remote Command	:DISPlay:WINDow[1]:TRACe:GRATicule:GRID[:STATe] OFF ON 0 1 :DISPlay:WINDow[1]:TRACe:GRATicule:GRID[:STATe]?
Example	DISP:WIND:TRAC:GRAT:GRID OFF
Notes	The graticule is the set of horizontal and vertical lines that make up the grid/divisions for the x-axis and y-axis.
Preset	On
State Saved	Saved in instrument state
Initial S/W Revision	Prior to A.02.00

## System Display Settings

These settings are "Mode Global" – they affect all modes and measurements and are reset only by Restore Misc Defaults or Restore System Defaults under System.

Key Path	View/Display, Display
Initial S/W Revision	Prior to A.02.00

## Annotation Local Settings

This is a Mode Global override of the meas local annotation settings. When it is All Off, it forces ScreenAnnotation, Meas Bar, Trace, and Active Function Values settings to be OFF for all measurements in all modes. This provides the security based "annotation off" function of previous analyzers; hence it uses the legacy SCPI command.

When it is All Off, the Screen, Meas Bar, Trace, and Active Function Values keys under the Display, Annotation menu are grayed out and forced to Off. When Local Settings is selected, you are able to set the local annotation settings on a measurement by measurement basis.

Key Path	View/Display, Display, System Display Settings
Remote Command	:DISPlay:WINDow[1]:ANNotation[:ALL] OFF ON 0 1 :DISPlay:WINDow[1]:ANNotation[:ALL]?
Example	:DISP:WIND:ANN OFF
Preset	On (Set by Restore Misc Defaults)
State Saved	Not saved in instrument state.
Backwards Compatibility Notes	The WINDow parameter and optional subopcode is included for backwards compatibility but ignored – all windows are equally affected.
Initial S/W Revision	Prior to A.02.00



## Themes

Accesses a menu of functions that enable you to choose the theme to be used when saving the screen image.

The **Themes** option is the same as the **Themes** option under the **Display** and **Page Setup** dialogs. It allows you to choose between themes to be used when saving the screen image.

<b>Key Path</b>	Save, Screen Image
<b>Remote Command</b>	:MMEMory:STORe:SCReem:THEMe TDColor   TDMonochrome   FCOlor   FMONochrome  :MMEMory:STORe:SCReem:THEMe?
<b>Example</b>	:MMEM:STOR:SCR:THEM TDM
<b>Preset</b>	3D Color; Is not part of Preset, but is reset by Restore Misc Defaults or Restore System Defaults All and survives subsequent running of the modes.
<b>Readback</b>	3D Color   3D Mono   Flat Color   Flat Mono
<b>Backwards Compatibility Notes</b>	In ESA and PSA we offer the choice of "Reverse Bitmap" or "Reverse Metafile" when saving screen images. This is much like the "Flat Color" theme available in X-Series. Also, if you selected Reverse Bitmap AND a black & white screen image, that would be much like "Flat Monochrome". In other words, each of the X-Series themes has a similar screen image type in ESA/PSA. But they are not identical.
<b>Initial S/W Revision</b>	Prior to A.02.00

### 3D Color

Selects a standard color theme with each object filled, shaded and colored as designed.

<b>Key Path</b>	Save, Screen Image, Themes
<b>Example</b>	MMEM:STOR:SCR:THEM TDC
<b>Readback</b>	3D Color
<b>Initial S/W Revision</b>	Prior to A.02.00

### 3D Monochrome

Selects a format that is like 3D color but shades of gray are used instead of colors.

<b>Key Path</b>	Save, Screen Image, Themes
<b>Example</b>	MMEM:STOR:SCR:THEM TDM
<b>Readback</b>	3D Mono
<b>Initial S/W Revision</b>	Prior to A.02.00

### Flat Color

Selects a format that is best when the screen is to be printed on an ink printer.

Key Path	Save, Screen Image, Themes
<b>Example</b>	MMEM:STOR:SCR:THEM FCOL
Readback	Flat Color
Initial S/W Revision	Prior to A.02.00

### Flat Monochrome

Selects a format that is like Flat Color. But only black is used (no colors, not even gray), and no fill.

Key Path	Save, Screen Image, Themes
<b>Example</b>	MMEM:STOR:SCR:THEM FMON
Readback	Flat Mono
Initial S/W Revision	Prior to A.02.00

### Backlight

Accesses the display backlight on/off keys. This setting may interact with settings under the Windows "Power" menu.

When the backlight is off, pressing ESC, TAB, SPACE, ENTER, UP, DOWN, LEFT, RIGHT, DEL, BKSP, CTRL, or ALT turns the backlight on without affecting the application. Pressing any other key will turn backlight on and could potentially perform the action as well.

Key Path	View/Display, Display, System Display Settings
<b>Remote Command</b>	:DISPlay:BACKlight ON OFF :DISPlay:BACKlight?
Preset	ON (Set by Restore Misc Defaults)
Initial S/W Revision	Prior to A.02.00

### Backlight Intensity

An active function used to set the backlight intensity. It goes from 0 to 100 where 100 is full on and 0 is off. This value is independent of the values set under the Backlight on/off key.

Key Path	View/Display, Display, System Display Settings
<b>Remote Command</b>	:DISPlay:BACKlight:INTensity <integer> :DISPlay:BACKlight:INTensity?
<b>Example</b>	DISP:BACK:INT 50

Preset	100 (Set by Restore Misc Defaults)
Min	0
Max	100
Initial S/W Revision	Prior to A.02.00

## Expand Meters

Enables you to enlarge annotation/indicator of meters graph display.

Key Path	View/ Display
<b>Remote Command</b>	:DISPlay:SCHart:VIEW:EXPand:METer[:STATe] ON OFF 1 0 :DISPlay:SCHart:VIEW:EXPand:METer[:STATe]?
<b>Example</b>	:DISP:SCH:VIEW:EXP:MET 1 :DISP:SCH:VIEW:EXP:MET?
Preset	OFF
State Saved	Saved in instrument state.
Initial S/W Revision	A.11.00

## Strip Chart View

This view displays a strip chart on the left and Meters on the right.

# 9 Strip Chart Measurement View/Display

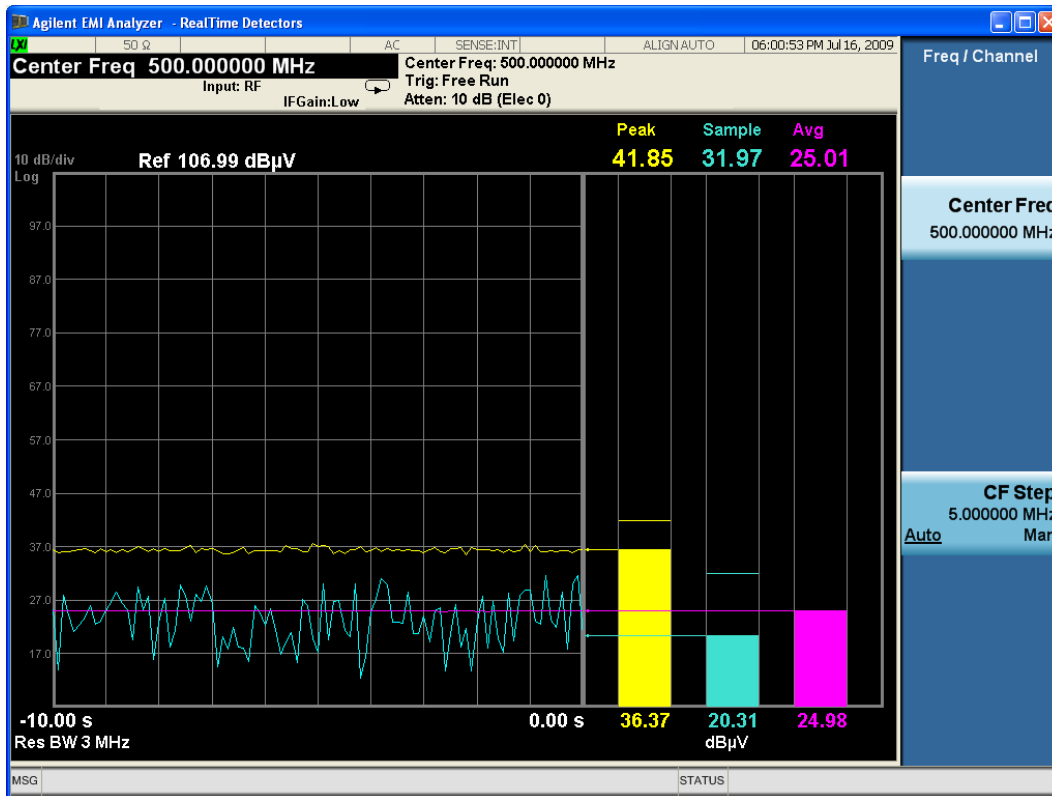

## 10 Monitor Spectrum Measurement

The Monitor Spectrum measurement is an EMI measurement for the X-Series platform that can be used for troubleshooting in pre-compliance and compliance tests. The Monitor Spectrum measurement is capable of measuring a signal and displaying both an RF Spectrum and three EMI detectors simultaneously.

This topic contains the following sections:

["Measurement Commands for Monitor Spectrum" on page 726](#)

["Remote Command Results for Monitor Spectrum Measurement" on page 727](#)

["Dependencies" on page 728](#)

## Measurement Commands for Monitor Spectrum

INITiate:MONitor

CONFigure:MONitor

CONFigure?

MEASure:MONitor[n]?

READ:MONitor[n]?

FETCh:MONitor[n]?

## Remote Command Results for Monitor Spectrum Measurement

Command	N	Results Returned
INITiate:MONitor	n/a	n/a
CONFigure?	n/a	name of current measurement: " MON"
CONFigure:MONitor	n/a	n/a (selects Monitor Spectrum measurement in Meas Preset state)
INITiate:MONitor	n/a	n/a (selects Monitor Spectrum measurement without affecting settings)
FETCh:MONitor [n]? MEASure:MONitor [n]? READ:MONitor [n]?	Not specified or n=1	Return the following comma-separated scalar results: 1. Current measurement result of Meter 1 2. Current measurement result of Meter 2 3. Current measurement result of Meter 3 Note : Return NaN (9.91E37) if the Meter is not available.
	n=2	Return the following comma-separated scalar results: 1. Max measurement result of Meter 1 2. Max measurement result of Meter 2 3. Max measurement result of Meter 3 Note : Return NaN (9.91E37) if the Meter is not available.
	n=3	This query returns Trace 1 data as a list of x,y pairs. The y-values are in the current Y Axis Unit of the analyzer. The x-axis values are the values of the trace, in the x-axis scale units of the trace (Hz for frequency domain traces, seconds for time domain traces). There are always 2001 points in Monitor Spectrum traces.
	n=4	Returns Trace 2 data as a series of x,y pairs. There are always 2001 points in Monitor Spectrum traces.
	n=5	Returns Trace 3 data as a series of x,y pairs. There are always 2001 points in Monitor Spectrum traces.
Key Path	Front-panel key	
Dependencies	<p>Monitor Spectrum is only available in the MXE EMI Receiver, and only in MXE's that contain option DP2. In all other cases the Monitor Spectrum key is blank in the Measure menu.</p> <p>If a SCPI command that would select Monitor Spectrum (MEASure READ FETCh CONFig) is sent to a CXA EXA MXA PXA, the error "Settings conflict; Feature not supported for this model number" is generated.</p> <p>If a SCPI command that would select Monitor Spectrum (MEASure READ FETCh CONFig) is sent to an MXE without option DP2, the error "Hardware missing; Option not installed" is generated. You will need to get an upgrade kit in this case, to add the 40 MHz wideband IF board to your MXE.</p>	
Initial S/W Revision	A.13.00	

## Dependencies

In Monitor Spectrum, there are five parameters with some interdependencies (limits and couplings). The diagram below shows the interdependencies:

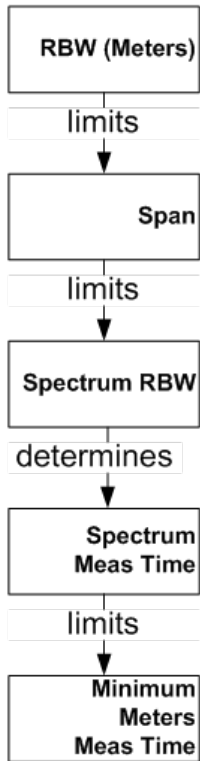

These dependencies are detailed in the key descriptions for Spectrum RBW and Span.

The measurement time is determined by the Span as shown in the table below and is annotated in the lower right corner of the Spectrum display. If this time is longer than the Meas Time that is set for the meters, the meters will use the Meas Time of the Spectrum display.

<b>Spectrum RBW</b>	<b>Meas Time</b>
10 Hz	268.5 ms
30 Hz	82.99 ms
100 Hz	26.85 ms
300 Hz	8.299 ms
1 kHz	2.685 ms
3 kHz	829.9 $\mu$ s
10 kHz	268.5 $\mu$ s
30 kHz	82.99 $\mu$ s
100 kHz	26.85 $\mu$ s



<b>Meters RBW</b>	<b>Max Spectrum RBW</b>	<b>Max Span</b>
1 MHz	100 kHz	10 MHz
120 kHz	100 kHz	10 MHz
100 kHz	100 kHz	10 MHz
10 kHz	10 kHz	2 MHz
9 kHz	10 kHz	1 MHz
1 kHz	1 kHz	200 kHz
200 Hz	100 Hz	20 kHz
100 Hz	100 Hz	20 kHz
10 Hz	30 Hz	2 kHz

## AMPTD Y Scale

Displays the menu keys that enable you to control the amplitude parameters.

Key Path	Front-panel key
Initial S/W Revision	A.13.00

### Reference Level

Specifies the amplitude represented by the topmost graticule line.

Key Path	AMPTD/Y Scale
<b>Remote Command</b>	:DISPlay:MONitor:VIEW[1]:WINDow[1]:TRACe:Y[:SCALe]:RLEVel <real> :DISPlay:MONitor:VIEW[1]:WINDow[1]:TRACe:Y[:SCALe]:RLEVel?
<b>Example</b>	DISP:MON:VIEW:WIND:TRAC:Y:RLEV 80 dBuV DISP:MON:VIEW:WIND:TRAC:Y:RLEV?
Preset	106.99 dBuV
State Saved	Saved in instrument state
Min	RefLevelMin = -63.01 dBuV + RefLevelOffset - ExtGain.
Max	RefLevelMax = 206.99 dBuV + RefLevelOffset - ExtGain
Default Unit	Depends on the current selected Y axis unit
Initial S/W Revision	A.13.00

### Attenuation

Enables you to set the value of the Attenuation parameter. This key only affects the Mechanical Attenuator in the EMI Receiver mode and has no Auto setting.

For the Frequency Scan measurement, this key only affects the attenuation used for meters.

The following amplitude parameters are not settable by the user and therefore do not appear in any menus:

Elec Attenuator	Disabled
Elec Attenuation	0dB
Meas Atten Step	2dB
Max Mixer Level	-10dBm

Key Path	AMPTD Y Scale
<b>Remote Command</b>	[:SENSe]:POWer[:RF]:ATTenuation <rel_ampl> [:SENSe]:POWer[:RF]:ATTenuation?

<b>Example</b>	POW:ATT 10 POW:ATT?
Preset	10 dB
State Saved	Saved in instrument state.
Min	0 dB
Max	50 dB (CXA) 60 dB (EXA) 70 dB (MXA, PXA& N9038A)
Default Unit	dB
<b>Backwards Compatibility SCPI</b>	:INPut [1]   2:ATTenuation
Backwards Compatibility SCPI Notes	This command above is included for ESU compatibility. The suffix [1]2 is irrelevant to the measurement, they are added solely for remote language compatibility. This SCPI is Meas Local and Context Sensitive.
Initial S/W Revision	A.07.00

## Scale/ Div

Sets the units per division of the vertical scale in the logarithmic display.

Key Path	AMPTD Y Scale
<b>Remote Command</b>	:DISPlay:MONitor:VIEW[1]:WINDow[1]:TRACe:Y[:SCALe]:PDIVision <rel_amp> :DISPlay:MONitor:VIEW[1]:WINDow[1]:TRACe:Y[:SCALe]:PDIVision?
<b>Example</b>	DISP:MON:VIEW:WIND:TRAC:Y:PDIV 5 dB DISP:MON:VIEW:WIND:TRAC:Y:PDIV?
Preset	10.00 dB
State Saved	Saved in instrument state
Min	0.10 dB
Max	20.00 dB
Initial S/W Revision	A.13.00

## Presel Center

When this key is pressed, the centering of the preselector filter is adjusted to optimize the amplitude accuracy at the frequency of the selected marker. If the selected marker is not on when Presel Center is pressed, the analyzer will turn on the selected marker, perform a peak search, and then perform centering on the marker's center frequency. If the selected marker is already on and between the start and stop frequencies of the analyzer, the analyzer performs the preselector calibration on that marker's frequency. If the selected marker is already on, but outside the frequency range between Start Freq and Stop Freq, the analyzer will first perform a peak search, and then perform centering on the marker's center frequency.

The value displayed on the Presel Adjust key will change to reflect the new preselector tuning (see Presel Adjust).

A number of considerations should be observed to ensure proper operation. See ["Proper Preselector Operation" on page 732](#).

<b>Key Path</b>	AMPTD Y Scale
<b>Remote Command</b>	[ :SENSe ] :POWer [ :RF ] :PCENter
<b>Example</b>	POW:PCEN
<b>Notes</b>	Note that the rules outlined above under the key description apply for the remote command as well as the key. The result of the command is dependent on marker position, and so forth. Any message shown by the key press is also shown in response to the remote command.
<b>Dependencies</b>	<ul style="list-style-type: none"> <li>• Grayed out if the microwave preselector is off. )</li> <li>• If the selected marker's frequency is below Band 1, advisory message 0.5001 is generated and no action is taken.</li> <li>• Grayed out if entirely in Band 0.</li> <li>• Blank in models that do not include a preselector, such as option 503. If the SCPI is sent in these instruments, it is accepted without error, and the query always returns 0.</li> <li>• Grayed out in the Spectrogram View.</li> </ul>
<b>Couplings</b>	<p>The active marker position determines where the centering will be attempted.</p> <p>If the analyzer is in a measurement such as averaging when centering is initiated, the act of centering the preselector will restart averaging but the first average trace will not be taken until the centering is completed.</p>
<b>Status Bits/OPC dependencies</b>	<p>When centering the preselector, *OPC will not return true until the process is complete and a subsequent measurement has completed, nor will results be returned to a READ or MEASure command.</p> <p>The Measuring bit should remain set while this command is operating and should not go false until the subsequent sweep/measurement has completed.</p>
<b>Initial S/W Revision</b>	Prior to A.02.00
<b>Modified at S/W Revision</b>	A.03.00

## Proper Preselector Operation

A number of considerations should be observed to ensure proper operation:

1. If the selected marker is off, the analyzer will turn on a marker, perform a peak search, and adjust the preselector using the selected marker's frequency. It uses the "highest peak" peak search method unqualified by threshold or excursion, so that there is no chance of a 'no peak found' error. It continues with that peak, even if it is the peak of just noise. Therefore, for this operation to work properly, there should be a signal on screen in a preselected range for the peak search to find.
2. If the selected marker is already on, the analyzer will attempt the centering at that marker's frequency. There is no preselector for signals below about 3.6 GHz, therefore if the marker is on a signal below 3.6 GHz, no centering will be attempted and an advisory message generated

3. In some models, the preselector can be bypassed. If it is bypassed, no centering will be attempted in that range and a message will be generated.

## Preselector Adjust

Allows you to manually adjust the preselector filter frequency to optimize its response to the signal of interest. This function is only available when "Presel Center" on page 897 is available.

For general purpose signal analysis, using Presel Center is recommended. Centering the filter minimizes the impact of long-term preselector drift. Presel Adjust can be used instead to manually optimize the preselector. One application of manual optimization would be to peak the preselector response, which both optimizes the signal-to-noise ratio and minimizes amplitude variations due to small (short-term) preselector drifting.

Key Path	AMPTD Y Scale
Scope	Meas Global
Remote Command	<code>[ :SENSe ] :POWer [ :RF ] :PADJust &lt;freq&gt;</code> <code>[ :SENSe ] :POWer [ :RF ] :PADJust?</code>
Example	POW:PADJ 100KHz POW:PADJ?
Notes	The value on the key reads out to 0.1 MHz resolution.
Dependencies	<ul style="list-style-type: none"> <li>• Grayed out if microwave preselector is off. )</li> <li>• Grayed out if entirely in Band 0.</li> <li>• Blank in models that do not include a preselector, such as option 503. If the SCPI is sent in these instruments, it is accepted without error, and the query always returns 0.</li> <li>• Grayed out in the Spectrogram View.</li> </ul>
Preset	0 MHz
State Saved	The Presel Adjust value set by Presel Center, or by manually adjusting Presel Adjust, is not saved in instrument state, and does not survive a Preset or power cycle.
Min	-500 MHz
Max	500 MHz
Default Unit	Hz
Backwards Compatibility SCPI	<code>[ :SENSe ] :POWer [ :RF ] :MW :PADJust</code> <code>[ :SENSe ] :POWer [ :RF ] :MMW :PADJust</code> PSA had multiple preselectors, but the X-Series has only one. These commands simply alias to <code>[ :SENSe ] :POWer [ :RF ] :PADJust</code>
Initial S/W Revision	Prior to A.02.00
Modified at S/W Revision	A.03.00

Remote Command	<code>[ :SENSe ] :POWer [ :RF ] :PADJust :PRESelector MWAVE   MMWave   EXTERNAL</code>
----------------	--

	<code>[ :SENSe ] :POWer [ :RF ] :PADJust :PRESelector?</code>
Notes	PSA had multiple preselectors, and you could select which preselector to adjust. Since the X-Series has only one mm/uW preselector, the preselector selection softkey is no longer available. However, to provide backward compatibility, we accept the legacy remote commands.  The command form has no effect, the query always returns MWAVE
Initial S/W Revision	Prior to A.02.00

## Y Axis Unit

Displays the menu keys that enable you to change the vertical (Y) axis amplitude unit. The analyzer retains the entered Y Axis Unit separately for both Log and Lin amplitude scale types. For example, if Scale Type has been set to Log, and you set Y Axis Unit to dBm, pressing Scale Type (Log) sets the Y Axis Unit to dBm. If Scale Type has been set to Lin and you set Y Axis Unit to V, pressing Scale Type (Lin) sets the Y Axis Unit to V. Pressing Scale Type (Log) again sets the Y axis unit back to dBm.

### NOTE

The units of current (A, dBmA, dBuA) are calculated based on 50 ohms input impedance.

All four of the EMI units (dBμA/m, dBμV/m, dBG, dBpT) are treated by the instrument exactly as though they were dBuV. The user must load an appropriate correction factor using Amplitude Corrections for accurate and meaningful results.

If a SCPI command is sent to the analyzer that uses one of the EMI units as a terminator, the analyzer treats it as though DBUV had been sent as the terminator.

Key Path	AMPTD Y Scale
Mode	SA
Scope	Meas Global
Remote Command	<code>:UNIT:POWer DBM   DBMV   DBMA   V   W   A   DBUV   DBUA   DBPW   DBUVM   DBUAM   DBPT   DBG</code>  <code>:UNIT:POWer?</code>
Example	UNIT:POW dBmV UNIT:POW?
Notes	The Y axis unit has either logarithmic or linear characteristics. The set of units that is logarithmic consists of dBm, dBmV, dBmA, dBμV, dBμA, dBμV/m, dBμA/m, dBpT, and dBG. The set of units that are linear consists of V, W, and A. The chosen unit will determine how the reference level and all the amplitude-related outputs like trace data, marker data, etc. read out.
Notes	The settings of Y Axis Unit and Scale Type, affect how the data is read over the remote interface. When using the remote interface no unit is returned, so you must know what the Y axis unit is to interpret the results:  Example 1, set the following: Scale Type (Log) Y Axis Unit, dBm Scale/Div, 1 dB Ref Level, 10 dBm

	<p>This sets the top line to 10 dBm with each vertical division representing 1 dB. Thus, if a point on trace 1 is on the fifth graticule line from the top, it represents 5 dBm and will read out remotely as 5.</p> <p>Example 2, set the following:</p> <p>Scale Type (Lin)</p> <p>Y Axis Unit, Volts</p> <p>Ref Level, 100 mV (10 mV/div)</p> <p>This sets the top line to 100 mV and the bottom line to 0 V, so each vertical division represents 10 mV. Thus, if a point on trace 1 is on the fifth graticule line from the top, it represents 50 mV and will read out remotely as 50.</p>
Dependencies	<p>If an amplitude correction with an Antenna Unit other than None is applied and enabled, then that antenna unit is forced and the key with that unit is the only Y Axis Unit available. All other Y Axis Unit keys are grayed out.</p> <p>If an amplitude correction with an Antenna Unit other than None is applied and enabled, and you then turn off that correction or set Apply Corrections to No, the Y Axis Unit that existed before the Antenna Unit was applied is restored.</p>
Couplings	The analyzer retains the entered Y Axis Unit separately for both Log and Lin amplitude scale types
Preset	dBm for log scale, V for linear. The true 'preset' value is dBm, since at preset the Y Scale type is set to logarithmic.
State Saved	Saved in instrument state
Readback line	1-of-N selection
Initial S/W Revision	Prior to A.02.00
Modified at S/W Revision	A.02.00, A.04.00, A.11.00

## dBm

Sets the amplitude unit for the selected amplitude scale (log/lin) to dBm.

Key Path	AMPTD Y Scale, Y Axis Unit
<b>Example</b>	UNIT:POW DBM
Dependencies	Grayed out if an Amplitude Correction with an Antenna Unit is ON.
Readback	dBm
Initial S/W Revision	Prior to A.02.00
Modified at S/W Revision	A.02.00

## dBmV

Sets the amplitude unit for the selected amplitude scale (log/lin) to dBmV.

Key Path	AMPTD Y Scale, Y Axis Unit
<b>Example</b>	UNIT:POW DBMV

Dependencies	Grayed out if an Amplitude Correction with an Antenna Unit is ON.
Readback	dBmV
Initial S/W Revision	Prior to A.02.00
Modified at S/W Revision	A.02.00

## dBmA

Sets the amplitude unit for the selected amplitude scale (log/lin) to dBmA.

Key Path	AMPTD Y Scale, Y Axis Unit
<b>Example</b>	UNIT:POW DBMA
Dependencies	Grayed out if an Amplitude Correction with an Antenna Unit is ON.
Readback	dBmA
Initial S/W Revision	Prior to A.02.00
Modified at S/W Revision	A.02.00

## W

Sets the amplitude unit for the selected amplitude scale (log/lin) to watt.

Key Path	AMPTD Y Scale, Y Axis Unit
<b>Example</b>	UNIT:POW W
Dependencies	Grayed out if an Amplitude Correction with an Antenna Unit is ON.
Readback	W
Initial S/W Revision	Prior to A.02.00
Modified at S/W Revision	A.02.00

## V

Sets the amplitude unit for the selected amplitude scale (log/lin) to volt.

Key Path	AMPTD Y Scale, Y Axis Unit
<b>Example</b>	UNIT:POW V
Dependencies	Grayed out if an Amplitude Correction with an Antenna Unit is ON.
Readback	V
Initial S/W Revision	Prior to A.02.00
Modified at S/W Revision	A.02.00



## A

Sets the amplitude unit for the selected amplitude scale (log/lin) to Ampere.

Key Path	AMPTD Y Scale, Y Axis Unit
<b>Example</b>	UNIT:POW A
Dependencies	Grayed out if an Amplitude Correction with an Antenna Unit is ON.
Readback	A
Initial S/W Revision	Prior to A.02.00
Modified at S/W Revision	A.02.00

## dB $\mu$ V

Sets the amplitude unit for the selected amplitude scale (log/lin) to dB $\mu$ V.

Key Path	AMPTD Y Scale, Y Axis Unit
<b>Example</b>	UNIT:POW DBUV
Dependencies	Grayed out if an Amplitude Correction with an Antenna Unit is ON.
Readback	dB $\mu$ V
Initial S/W Revision	Prior to A.02.00
Modified at S/W Revision	A.02.00

## dB $\mu$ A

Sets the amplitude unit for the selected amplitude scale (log/lin) to dB $\mu$ A.

**NOTE**

The unit dB $\mu$ A can also appear as an Antenna Unit. This will be used by customers using current probes, because current probes are often supplied with conversion tables that provide the transducer factors. When dB $\mu$ A is used as an Antenna Unit the normal conversion from power to amps for dB $\mu$ A (based on the analyzer input impedance) is not done, but instead the conversion is based solely on the Correction that contains the transducer factors. This is what distinguishes dB $\mu$ A as a normal unit from dB $\mu$ A as an antenna unit. When querying the Y-Axis unit, you can query the Antenna Unit to distinguish between regular dB $\mu$ A and the dB $\mu$ A antenna unit. If :CORR:CSET:ANT? returns NOC (for No Conversion), you are using a normal Y Axis dB $\mu$ A. If it returns UA you are using an Antenna Unit dB $\mu$ A.

Key Path	AMPTD Y Scale, Y Axis Unit
<b>Example</b>	UNIT:POW DBUA
Dependencies	Grayed out if an Amplitude Correction with an Antenna Unit is ON.
Readback	dB $\mu$ A
Initial S/W Revision	Prior to A.02.00
Modified at S/W Revision	A.02.00

## dBpW

Sets the amplitude unit for the selected amplitude scale (log/lin) to dBpW.

Key Path	AMPTD Y Scale, Y Axis Unit
<b>Example</b>	UNIT:POW DBPW
Dependencies	Grayed out if an Amplitude Correction with an Antenna Unit is ON.
Readback	dB $\mu$ A
Initial S/W Revision	A.11.00

## Antenna Unit

When a Correction is turned on that uses an Antenna Unit, the Y Axis Unit changes to that Antenna Unit. All of the keys in the Y-Axis Unit menu are then greyed out, except the Antenna Unit key. The unit being used is shown on this key and is shown as selected in the submenu.

Key Path	AMPTD Y Scale, Y Axis Unit
Dependencies	Grayed out if no Amplitude Correction with an Antenna Unit is on.
Readback line	Currently selected unit
Initial S/W Revision	A.11.00

## dB $\mu$ V/m

Sets the amplitude unit for the selected amplitude scale (log/lin) to dB $\mu$ V/m. This is an antenna unit, and this key is grayed out unless a Correction with this Antenna Unit selected is ON. If this is the case, all of the other Antenna Units are grayed out.

Key Path	AMPTD Y Scale, Y Axis Unit, Antenna Unit
<b>Example</b>	UNIT:POW DBUVM
Dependencies	Grayed out if no Amplitude Correction with an Antenna Unit is on.
Readback	dB $\mu$ V/m
Initial S/W Revision	A.02.00

## dB $\mu$ A/m

Sets the amplitude unit for the selected amplitude scale (log/lin) to dB $\mu$ A/m. This is an antenna unit, and this key is grayed out unless a Correction with this Antenna Unit selected is ON. If this is the case, all of the other Antenna Units are grayed out.

Key Path	AMPTD Y Scale, Y Axis Unit, Antenna Unit
----------	--

<b>Example</b>	UNIT:POW DBUAM
Dependencies	Grayed out if no Amplitude Correction with an Antenna Unit is on.
Readback	dB $\mu$ A/m
Initial S/W Revision	A.02.00

### dB $\mu$ A

Sets the amplitude unit for the selected amplitude scale (log/lin) to dB $\mu$ A. This is an antenna unit, and this key is grayed out unless a Correction with this Antenna Unit selected is ON. If this is the case, all of the other Antenna Units are grayed out.

Key Path	AMPTD Y Scale, Y Axis Unit, Antenna Unit
<b>Example</b>	UNIT:POW DBUAM
Dependencies	Grayed out if no Amplitude Correction with an Antenna Unit is on.
Readback	dB $\mu$ A
Initial S/W Revision	A.11.00

### dBpT

Sets the amplitude unit for the selected amplitude scale (log/lin) to dBpT. This is an antenna unit, and this key is grayed out unless a Correction with this Antenna Unit selected is ON. If this is the case, all of the other Antenna Units are grayed out.

Key Path	AMPTD Y Scale, Y Axis Unit, Antenna Unit
<b>Example</b>	UNIT:POW DBPT
Dependencies	Grayed out if no Amplitude Correction with an Antenna Unit is on.
Readback	dBpT
Initial S/W Revision	A.02.00

### DBG

Sets the amplitude unit for the selected amplitude scale (log/lin) to DBG. This is an antenna unit, and this key is grayed out unless a Correction with this Antenna Unit selected is ON. If this is the case, all of the other Antenna Units are grayed out.

Key Path	AMPTD Y Scale, Y Axis Unit, Antenna Unit
<b>Example</b>	UNIT:POW DBG
Dependencies	Grayed out if no Amplitude Correction with an Antenna Unit is on.
Readback	DBG
Initial S/W Revision	A.02.00

### None

This is selected if no Antenna Unit is currently on, however you cannot actually set this value, since it is always grayed out. The key is included simply to provide an indication on the Readback line of the Antenna Unit key when there is no Antenna Unit selected.

Key Path	AMPTD Y Scale, Y Axis Unit, Antenna Unit
Readback	"None"
Initial S/W Revision	A.11.00

### Reference Level Offset

Enables you to add an offset value to the displayed reference level. The reference level is the absolute amplitude represented by the top graticule line on the display.

Key Path	AMPTD Y Scale
Remote Command	:DISPlay:MONitor:VIEW[1]:WINDow[1]:TRACe:Y[:SCALe]:RLEVel:OFFSet <rel_ ampl> :DISPlay:MONitor:VIEW[1]:WINDow[1]:TRACe:Y[:SCALe]:RLEVel:OFFSet?
Example	DISP:MON:VIEW:WIND:TRAC:Y:RLEV:OFFS 12.7
Preset	0 dB
State Saved	Saved in instrument state
Min	The range for Ref Lvl Offset is variable. It is limited to values that keep the reference level within the range of -327.6 dB to 327.6 dB.
Max	327.6 dB
Initial S/W Revision	A.13.00

### Internal Preamp

Accesses a menu of keys that control the internal preamps. Turning on the preamp gives a better noise figure, but a poorer TOI to noise floor dynamic range. You can optimize this setting for your particular measurement.

The instrument takes the preamp gain into account as it sweeps. If you sweep outside of the range of the preamp the instrument will also account for that. The displayed result will always reflect the correct gain.

For some measurements, when the preamp is on and any part of the displayed frequency range is below the lowest frequency for which the preamp has specifications, a warning condition message appears in the status line. For example ,for a preamp with a 9 kHz lowest specified frequency: "Preamp: Accy unspec'd below 9 kHz".

Key Path	AMPTD Y Scale
----------	---------------

Scope	Meas Global
<b>Remote Command</b>	[ :SENSe] :POWer [ :RF] :GAIN [ :STATe] OFF ON 0 1 [ :SENSe] :POWer [ :RF] :GAIN [ :STATe] ?
Dependencies	Preamp is not available on all hardware platforms. If the preamp is not present or is unlicensed, the key is not shown. The preamp is not available when the electronic/soft attenuator is enabled.
Couplings	The act of connecting the U7227A USB Preamplifier to one of the analyzer's USB ports will cause the Internal Preamp to be switched on. When this happens an informational message will be generated: "Internal Preamp turned on for optimal operation with USB Preamp." Note that if the Internal Preamp was already on, there will be no change to the setting, but if it was Off it will be switched On, to Full Range. Note that this same action occurs when the SA mode is selected while the USB Preamp is connected to one of the analyzer's USB ports, if it is the first time that the SA mode has run since powerup, or if the last time the SA mode was running the USB Preamp was NOT connected. Subsequently disconnecting the USB Preamp from USB does not change the Internal Preamp setting nor restore the previous setting.
Preset	OFF
State Saved	Saved in instrument state
Initial S/W Revision	Prior to A.02.00
Modified at S/W Revision	A.14.00

Key Path	AMPTD Y Scale, Internal Preamp
Scope	Meas Global
<b>Remote Command</b>	[ :SENSe] :POWer [ :RF] :GAIN :BAND LOW FULL [ :SENSe] :POWer [ :RF] :GAIN :BAND ?
Dependencies	Preamp is not available on all hardware platforms. If the preamp is not present or is unlicensed, the key is not shown. If a POW:GAIN:BAND FULL command is sent when a low band preamp is available, the preamp band parameter is to LOW instead of FULL, and an "Option not installed" message is generated.
Preset	LOW
State Saved	Saved in instrument state
Initial S/W Revision	Prior to A.02.00

## Off

Turns the internal preamp off

Key Path	AMPTD Y Scale, Internal Preamp
----------	--------------------------------

<b>Example</b>	:POW:GAIN OFF
<b>Readback</b>	Off
<b>Initial S/W Revision</b>	Prior to A.02.00

## Low Band

Sets the internal preamp to use only the low band.

The frequency range of the installed (optional) low-band preamp is displayed in square brackets on the Low Band key label.

<b>Key Path</b>	AMPTD Y Scale, Internal Preamp
<b>Example</b>	:POW:GAIN ON :POW:GAIN:BAND LOW
<b>Readback</b>	Low Band
<b>Initial S/W Revision</b>	Prior to A.02.00

## Full Range

Sets the internal preamp to use its full range. The low band (0–3.6 GHz or 0–3GHz, depending on the model) is supplied by the low band preamp and the frequencies above low band are supplied by the high band preamp.

The frequency range of the installed (optional) preamp is displayed in square brackets on the Full Range key label. If the high band option is not installed the Full Range key does not appear.

<b>Key Path</b>	AMPTD Y Scale, Internal Preamp
<b>Example</b>	:POW:GAIN ON :POW:GAIN:BAND FULL
<b>Readback</b>	Full Range
<b>Initial S/W Revision</b>	Prior to A.02.00

## Y Axis Unit

Display the menu keys that enable you to change the vertical (Y) axis amplitude unit. .For details about this key, see Y Axis Unit@32002.

## Internal Preamp

Accesses a menu of keys that control the internal preamps. Turning on the preamp gives a better noise figure, but a poorer TOI to noise floor dynamic range. You can optimize this setting for your particular measurement.

The instrument takes the preamp gain into account as it sweeps. If you sweep outside of the range of the preamp the instrument will also account for that. The displayed result will always reflect the correct gain.

For some measurements, when the preamp is on and any part of the displayed frequency range is below the lowest frequency for which the preamp has specifications, a warning condition message appears in the status line. For example ,for a preamp with a 9 kHz lowest specified frequency: "Preamp: Accy unspec'd below 9 kHz".

Key Path	AMPTD Y Scale
Scope	Meas Global
Remote Command	[ :SENSe] :POWeR [ :RF] :GAIN [ :STATe] OFF ON 0 1 [ :SENSe] :POWeR [ :RF] :GAIN [ :STATe] ?
Dependencies	Preamp is not available on all hardware platforms. If the preamp is not present or is unlicensed, the key is not shown. The preamp is not available when the electronic/soft attenuator is enabled.
Couplings	The act of connecting the U7227A USB Preamplifier to one of the analyzer's USB ports will cause the Internal Preamp to be switched on. When this happens an informational message will be generated: "Internal Preamp turned on for optimal operation with USB Preamp." Note that if the Internal Preamp was already on, there will be no change to the setting, but if it was Off it will be switched On, to Full Range. Note that this same action occurs when the SA mode is selected while the USB Preamp is connected to one of the analyzer's USB ports, if it is the first time that the SA mode has run since powerup, or if the last time the SA mode was running the USB Preamp was NOT connected. Subsequently disconnecting the USB Preamp from USB does not change the Internal Preamp setting nor restore the previous setting.
Preset	OFF
State Saved	Saved in instrument state
Initial S/W Revision	Prior to A.02.00
Modified at S/W Revision	A.14.00

Key Path	AMPTD Y Scale, Internal Preamp
Scope	Meas Global
Remote Command	[ :SENSe] :POWeR [ :RF] :GAIN :BAND LOW FULL [ :SENSe] :POWeR [ :RF] :GAIN :BAND?
Dependencies	Preamp is not available on all hardware platforms. If the preamp is not present or is unlicensed, the key is not shown. If a POW:GAIN:BAND FULL command is sent when a low band preamp is available, the preamp band parameter is to LOW instead of FULL, and an "Option not installed" message is generated.
Preset	LOW
State Saved	Saved in instrument state
Initial S/W Revision	Prior to A.02.00

## Internal Preamp State (Remote Command Only)

This command is used to set the Internal Preamp state of meters display.

<b>Remote Command</b>	:INPut [1]   2 :GAIN [ :STATe] ON OFF 1 0 :INPut [1]   2 :GAIN [ :STATe] ?
<b>Example</b>	INP:GAIN OFF INP:GAIN?
<b>Notes</b>	This command is included for ESU compatibility. The suffix [1]2 is irrelevant to the measurement, they are added solely for remote language compatibility. ON is aliased to POW:GAIN ON; :POW:GAIN:BAND LOW. OFF is aliased to POW:GAIN OFF.
<b>Preset</b>	OFF
<b>State Saved</b>	Saved in instrument state
<b>Initial S/W Revision</b>	A.13.00

## Grid Bottom Level (Remote Command Only)

This command defines the bottom grid level in the current unit for the spectrum display.

<b>Remote Command</b>	:DISPlay [ :WINDow] :TRACe [1]   2   3 :Y [ :SCALe] :BOTTom <real> :DISPlay [ :WINDow] :TRACe [1]   2   3 :Y [ :SCALe] :BOTTom?
<b>Example</b>	DISP:TRAC:Y:BOTT 5 DISP:TRAC:Y:BOTT?
<b>Notes</b>	This command is included for ESU compatibility. The suffix [1]2 and [1]2 3 are irrelevant to the measurement, they are added solely for remote language compatibility.
<b>Couplings</b>	When this value is change, the reference level will be changed based on: Ref Level = Min Grid Level +10* Scale/Div The value of bottom grid level will be recalculated based on the exact Ref Level value. Similar to Ref Level, the allowed range of Grid Level set is affected by the Ref Level Offset Value.
<b>Preset</b>	6.99 dBuV
<b>State Saved</b>	Saved in instrument state
<b>Min</b>	-163.01 dBuV
<b>Max</b>	36.99 dBuV
<b>Backwards Compatibility SCPI</b>	:DISPlay:WINDow [1]   2 :TRACe [1]   2   3 :Y [ :SCALe] :BOTTom
<b>Backwards Compatibility SCPI Notes</b>	The SCPI command is not stated in ESU user manual, but it is used by the EMC32 application.
<b>Initial S/W Revision</b>	A.13.00



## Grid Top Level (Remote Command Only)

This command defines the top grid level in the current unit for the spectrum display. This command is different from Reference level where it will adjust the scale per division based on the value set for the bottom grid level.

<b>Remote Command</b>	<code>:DISPlay[:WINDow]:TRACe[1] 2 3:Y[:SCALe]:TOP &lt;real&gt;</code> <code>:DISPlay[:WINDow]:TRACe[1] 2 3:Y[:SCALe]:TOP?</code>
<b>Example</b>	DISP:TRAC:Y:TOP 5 DISP:TRAC:Y:TOP?
<b>Notes</b>	This command is included for ESU compatibility. It is not stated in ESU user manual, but it is used by the EMC32 application. The suffix [1]2 3 are irrelevant to the measurement, they are added solely for remote language compatibility.
<b>Couplings</b>	When this value is changed, the reference level will be changed to the same value. The Scale per division will be changed based on: $Scale/Div = (Top\ Grid\ Level - Bottom\ Grid\ Level) / 10$ The value of the bottom grid level will be recalculated based on the exact Scale/Div value. Similar to Ref Level, the allowed range of Grid Level set is affected by the Ref Level Offset Value.
<b>Preset</b>	106.99 dBuV
<b>State Saved</b>	Saved in instrument state
<b>Min</b>	-63.01 dBuV
<b>Max</b>	136.99 dBuV
<b>Backwards Compatibility SCPI</b>	<code>:DISPlay:WINDow[1] 2:TRACe[1] 2 3:Y[:SCALe]:TOP</code>
<b>Backwards Compatibility SCPI Notes</b>	The SCPI command is not stated in ESU user manual, but it is used by the EMC32 application.
<b>Initial S/W Revision</b>	A.13.00

## Auto Couple

The Auto Couple feature provides a quick and convenient way to automatically couple multiple instrument settings. This helps ensure accurate measurements and optimum dynamic range. When the Auto Couple feature is activated, either from the front panel or remotely, all parameters of the current measurement that have an Auto/Manual mode are set to Auto mode and all measurement settings dependent on (or coupled to) the Auto/Man parameters are automatically adjusted for optimal performance.

However, the Auto Couple key actions are confined to the current measurement only. It does not affect other measurements in the mode, and it does not affect markers, marker functions, or trace or display attributes.

See ["More Information" on page 746](#)

Key Path	Front-panel key
Remote Command	:COUPLe ALL NONE
Example	:COUP ALL
Notes	:COUPLe ALL puts all Auto/Man parameters in Auto mode (equivalent to pressing the Auto Couple key). :COUPLE NONE puts all Auto/Man parameters in manual mode. It decouples all the coupled instrument parameters and is not recommended for making measurements.
Initial S/W Revision	Prior to A.02.00

### More Information

There are two types of functions that have Auto/Manual modes.

#### Auto/Man Active Function keys

An Auto/Man toggle key controls the binary state associated with an instrument parameter by toggling between Auto (where the parameter is automatically coupled to the other parameters it is dependent upon) and Man (where the parameter is controlled independent of the other parameters), as well as making the parameter the active function. The current mode is indicated on the softkey with either Auto or Man underlined as illustrated below.

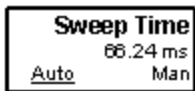

usd07

#### Auto/Man 1-of-N keys

An Auto/Man 1-of-N key allows you to manually pick from a list of parameter values, or place the function in Auto, in which case the value is automatically selected (and indicated) as shown below. If in Auto, Auto is underlined on the calling key. If in manual operation, manual is indicated on the calling key. But the calling key does not actually toggle the function, it simply opens the menu.

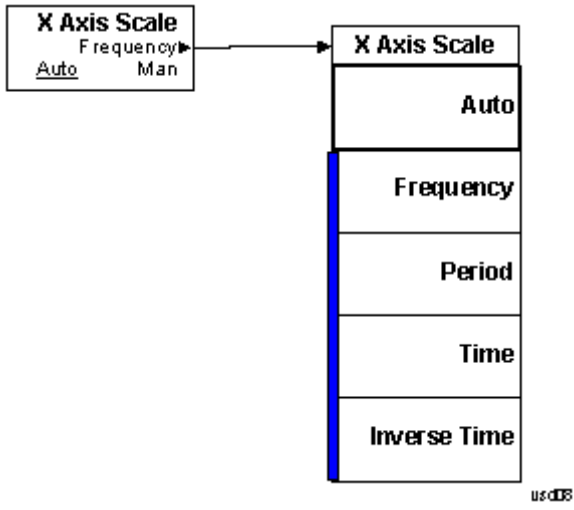

## BW

Displays the menu keys that enable you to control the BW parameters.

Key Path	Front-panel key
Initial S/W Revision	A.13.00

## RBW (Meters)

Activates the Resolution Bandwidth (RBW) action function, which allows you to manually set the RBW. For the Monitor Spectrum measurement, this key only affects the RBWs used for meters.

Key Path	BW
Remote Command	<pre>[ :SENSe]:BANDwidth BWIDth[:RESolution] &lt;freq&gt; [:SENSe]:BANDwidth BWIDth[:RESolution]? [:SENSe]:BANDwidth BWIDth[:RESolution]:AUTO OFF ON 0 1 [:SENSe]:BANDwidth BWIDth[:RESolution]:AUTO?</pre>
Example	<pre>BAND 200kHz BAND? BAND:AUTO 0 BAND:AUTO?</pre>
Notes	<p>For numeric entries, the RBW chooses the nearest (arithmetically, on a linear scale, rounding up) available RBW to the value entered.</p> <p>For Monitor Spectrum, the set of RBW's available is more limited than in other measurements. Therefore when switching to the Monitor Spectrum measurement, the current RBW is changed to the closest available Monitor Spectrum RBW.</p> <p>For Monitor Spectrum, only the following RBW's are available (these are all 6 dB bandwidths, regardless of the current EMC standard):</p> <p>When EMC Std is None, the available values are 1 MHz, 120 kHz, 100 kHz, 10 kHz, 9 kHz, 1 kHz, 200 Hz, 100 Hz, 10 Hz.</p> <p>When EMC Std is CISPR, the available values are 1 MHz, 120 kHz, 9 kHz, 1 kHz, 200 Hz, 100 Hz, 10 Hz.</p> <p>When EMC Std is MIL, the available values are 1 MHz, 100 kHz, 10 kHz, 1 kHz, 100 Hz, 10 Hz.</p>
Dependencies	<p>When EMC Std is set to None, there is no Auto setting for RBW (Meters). The Auto/Man line on this softkey disappears in this case, and if the SCPI command [:SENSe]:BWID[:RESolution]:AUTO ON is sent, it generates an error.</p>
Couplings	<p>When a CISPR or MIL EMI Standard is in use, the RBW (Meters) in Auto mode is coupled to Center Frequency.</p> <p>When CISPR is in use, RBW (Meters) in Auto is:</p> <p>200 Hz (CF - Band A, 9 kHz to 150 kHz)</p> <p>9 kHz (CF - Band B, 150 kHz to 30 MHz)</p>

	<p>120 kHz (CF - Band C and D, 30 MHz to 1 GHz).          1 MHz (CF - Band E, 1 GHz to 18 GHz)          When MIL is in use, RBW (Meters) in Auto is:          10 Hz (CF - less than 1 kHz)          100 Hz (CF - 1 kHz to 10 kHz)          1 kHz (CF - 10 kHz to 150 kHz)          10 kHz (CF - 150 kHz o 30 MHz)          100 kHz (CF - 30 MHz to 1 GHz)          1 MHz (CF - others)</p>
Preset	<p>120 kHz          ON</p>
State Saved	Saved in instrument state
Min	10 Hz
Max	1 MHz
Default Unit	Hz
<b>Backwards Compatibility SCPI</b>	:SENSe1 SENSe2  [SENSe]:BANDwidth BWIDth[:RESolution]
Backwards Compatibility SCPI Notes	This command above is included for ESU compatibility. The suffix 1 2 is irrelevant to the measurement, they are added solely for remote language compatibility.
Initial S/W Revision	A.13.00

## RBW (Spectrum)

Activates the Spectrum Resolution Bandwidth active function, which allows you to manually set the resolution bandwidth (RBW) of the Spectrum window. The Spectrum RBW can be set from 10 Hz to 100 kHz in steps of 1, 3, 10. It typically cannot be set higher than 10% of the Meters RBW (see Dependencies in the following table).

Key Path	BW
Remote Command	<pre>[ :SENSe ] :MONitor :SPECtrum :BANDwidth [ :RESolution ] &lt;freq&gt; [ :SENSe ] :MONitor :SPECtrum :BANDwidth [ :RESolution ] ?</pre>
Example	<pre>MON:SPEC:BAND 1 KHZ MON:SPEC:BAND?</pre>
Notes	<p>For numeric entries, all RBW Types choose the nearest (arithmetically, on a linear scale, rounding up) available RBW to the value entered.</p> <p>For the Spectrum RBW, only the following RBW's are available (these are all 6 dB bandwidths, regardless of the current EMC standard):          10 Hz, 30 Hz, 100 Hz, 300 Hz, 1 kHz, 3 kHz, 10 kHz, 30 kHz, 100 kHz.</p>
Dependencies	Spectrum RBW is limited to specific ranges depending on the Span, as shown below.

10 MHz	10 kHz - 100 kHz
5 MHz	10 kHz - 100 kHz
2 MHz	1 kHz - 10 kHz
1 MHz	1 kHz - 10 kHz
500 kHz	300 Hz - 3 kHz
200 kHz	100 Hz - 1 kHz
100 kHz	100 Hz - 1 kHz
50 kHz	30 Hz - 300 Hz
20 kHz	10 Hz - 100 Hz
10 kHz	10 Hz - 100 Hz
5 kHz	10 Hz - 30 Hz
2 kHz	10 Hz - 30 Hz
1 kHz	10 Hz - 30 Hz

Preset	10 kHz
State Saved	Saved in instrument state
Min	10 Hz
Max	100 kHz
Default Unit	Hz
<b>Backwards Compatibility SCPI</b>	:SENSe1   SENSe2   [SENSe] :BANDwidth   BWIDth : IF
Backwards Compatibility SCPI Notes	This command above is included for ESU compatibility. The suffix 1 2 is irrelevant to the measurement, they are added solely for remote language compatibility.
Initial S/W Revision	A.13.00

## Cont (Continuous Measurement/Sweep)

Sets the analyzer for Continuous measurement operation. The single/continuous state is Meas Global so the setting will affect all measurements. If you are Paused, pressing Cont does a Resume.

Key Path	Front-panel key
Remote Command	:INITiate:CONTinuous OFF ON 0 1 :INITiate:CONTinuous?
Example	:INIT:CONT 0 puts analyzer in Single measurement operation. :INIT:CONT 1 puts analyzer in Continuous measurement operation
Preset	ON (Note that SYST:PRESet sets INIT:CONT to ON but *RST sets INIT:CONT to OFF)
State Saved	Saved in instrument state
Backwards Compatibility Notes	For Spectrum Analysis mode in ESA and PSA, there is no Cont hardkey, instead there is a Sweep Single/Cont key. In these analyzers, switching the Sweep Single/Cont key from Single to Cont restarts averages (displayed average count reset to 1), but does not restart Max Hold and Min Hold. The X-Series has Single and Cont keys in place of the SweepSingleCont key. In the X-Series, if in single measurement, the Cont key (and INIT:CONT ON ) switches to continuous measurement, but never restarts a measurement and never resets a sweep.
Initial S/W Revision	Prior to A.02.00

In Swept SA Measurement (Spectrum Analysis Mode):

The analyzer takes repetitive sweeps, averages, measurements, etc., when in Continuous mode. When the average count reaches the Average/Hold Number the count stops incrementing, but the analyzer keeps sweeping. See the Trace/Detector section for the averaging formula used both before and after the Average/Hold Number is reached. The trigger condition must be met prior to each sweep. The type of trace processing for multiple sweeps, is set under the Trace/Detector key, with choices of Trace Average, Max Hold, or Min Hold.

In Other Measurements/Modes:

With Avg/Hold Num (in the Meas Setup menu) set to Off or set to On with a value of 1, a sweep is taken after the trigger condition is met; and the analyzer continues to take new sweeps after the current sweep has completed and the trigger condition is again met. However, with Avg/Hold Num set to On with a value >1, multiple sweeps (data acquisitions) are taken for the measurement. The trigger condition must be met prior to each sweep. The sweep is not stopped when the average count k equals the number N set for Avg/Hold Num is reached, but the number k stops incrementing. A measurement average usually applies to all traces, marker results, and numeric results. But sometimes it only applies to the numeric results.

If the analyzer is in Single measurement, pressing the Cont key does not change k and does not cause the sweep to be reset; the only action is to put the analyzer into Continuous measurement operation.

If it is already in continuous sweep:

the INIT:CONT 1 command has no effect

10 Monitor Spectrum Measurement  
Cont (Continuous Measurement/Sweep)

the INIT:CONT 0 command will place the analyzer in Single Sweep but will have no effect on the current sequence until  $k = N$ , at which point the current sequence will stop and the instrument will go to the idle state.



File

See "File" on page 266

## FREQ Channel

Displays the menu keys that enable you to control the frequency parameters and scale type.

Key Path	Front-panel key
Initial S/W Revision	A.13.00

### Frequency

Sets the frequency of Meters in the Frequency Scan measurement. For the Strip Chart measurement, this key will set the frequency for both meters and strip chart. For APD measurement, this key is used to set the frequency to perform Amplitude Probability Distribution. For Monitor Spectrum measurement, this key is used to set the Center Frequency.

Key Path	FREQ Channel
<b>Remote Command</b>	<code>[ :SENSe ] :FREQuency:CENTer &lt;frequency&gt;</code> <code>[ :SENSe ] :FREQuency:CENTer ?</code>
<b>Example</b>	FREQ:CENT 3 GHZ FREQ:CENT?
Notes	For the Frequency Scan measurement, when QPD, EMI Average or RMS Average detectors is selected, you will see some delay for meters to reflect the new data due to filtering time. However, if the change in the meters frequency is performed by knob or step keys, there will be no filtering time added unless the change of the meters frequency has triggered other parameter changes.
Preset	515 MHz
State Saved	Saved in instrument state.
Min	For Frequency Scan and Strip Chart measurements, it depends on the instrument minimum frequency.
Max	For Frequency Scan, and Strip Chart measurements, it depends on the instrument maximum frequency.
Default Unit	Hz
Status Bits/OPC dependencies	non-overlapped
<b>Backwards Compatibility SCPI</b>	<code>:SENSe1   SENSe2   [SENSe] :FREQuency:CENTer</code> <code>:SENSe1   SENSe2   [SENSe] :FREQuency:FIXed</code>
Backwards Compatibility SCPI Notes	These commands above are included for ESU compatibility. The suffix 1 2 is irrelevant to the measurement, they are added solely for remote language compatibility.
Initial S/W Revision	A.07.00

### Freq/ Step

Changes the step size for the Frequency.

Key Path	FREQ Channel
Remote Command	[ :SENSe ] :FREQuency:CENTer:STEP [ :INCRement ] <freq> [ :SENSe ] :FREQuency:CENTer:STEP [ :INCRement ] ? [ :SENSe ] :FREQuency:CENTer:STEP:AUTO OFF   ON   0   1 [ :SENSe ] :FREQuency:CENTer:STEP:AUTO?
Example	FREQ:CENT:STEP:AUTO ON FREQ:CENT:STEP 500 MHz FREQ:CENT UP increases the current center frequency value by 500 MHz FREQ:CENT:STEP? FREQ:CENT:STEP:AUTO?
Notes	Preset and Max values are dependent on Hardware Options (503, 508, 513, 526)
Preset	Auto ON
State Saved	Saved in instrument state
Min	- ( the maximum frequency of the instrument). (that is, a 27 GHz max freq instrument has a CF step range of +/- 27 GHz)
Max	The maximum frequency of the instrument. (that is, a 27 GHz max freq instrument has a CF step range of +/- 27 GHz)
Default Unit	Hz
Status Bits/OPC dependencies	non-overlapped
Initial S/W Revision	A.07.00

### CF → Signal (Replace)

Replaces the frequency of the selected signal with the Center Frequency (and Meters Freq since they are the same). Amplitude values and Delta To Limit values will be shown as “---” to indicate that those values are undefined until the next scan/final measurement value.

Key Path	Freq
Remote Command	:CALCulate:MONitor:SLIS:REPLace:METer <integer>
Example	CALC:MON:SLIS:REPL:MET 20 Replace Signal #20 with Center Freq
Notes	If the signal list contains no data, an error is generated and this function cannot be performed. If the selected signal is not in the list, an error is generated and this function cannot be performed.
Initial S/W Revision	A.13.00

### CF → List (Append)

Append the signal at the Center Frequency (and Meters Freq since they are the same) into the Frequency Scan signal list. Amplitude values and Delta To Limit values will be shown as “---” to indicate that those

values are undefined until the next scan/final measurement.

Key Path	Freq
<b>Remote Command</b>	:CALCulate:MONitor:SLIS:APPend:METer
<b>Example</b>	CALC:MON:SLIS:APP:MET
Notes	<p>If there is no free space in the signal list, you will be prompted by a message that asks whether to continue or not: WARNING! There is not enough free space in Signal List. Would you like to clear the Signal list before adding signals? Press ENTER to continue or ESC to Cancel.</p> <p>If the user sends the SCPI command when there is no free space in the signal list, the application will just clear the signal list. Pop up is only for key press.</p>
Couplings	The appended signal will be the selected signal after Meters→ List is performed.
Initial S/W Revision	A.13.00

## Input/Output

See ["Input/Output" on page 150](#)

## Marker

Access the Marker menu. The functions in this menu include a 1-of-N selection of the control mode Normal, Delta or Off for the selected marker. If the selected marker is Off, pressing Marker sets it to Normal and places it at the center of the screen on the trace determined by the Marker Trace rules. At the same time, the reference value of the selected marker appears on the Active Function area.

The marker X axis value entered in the active function area will display the marker value to its full entered precision.

Key Path	Front-panel key
Remote Command	:CALCulate:MONitor:MARKer[1] 2 ... 12:MODE POSition   DELTA   OFF :CALCulate:MONitor:MARKer[1] 2 ... 12:MODE?
Example	CALC:MON:MARK:MODE OFF CALC:MON:MARK:MODE?
Notes	If the selected marker is Off, pressing Marker sets it to Normal and places it at the center of the screen on the trace determined by the Marker Trace rules. At the same time, Marker X Axis Value appears in the Active Function area.  Default Active Function: the active function for the selected marker's current control mode. Note that if the current control mode is Off, there is no active function and the active function is turned off.  Active Function Display: the marker X axis value entered in the active function area will display the marker value to its fully entered precision.
Preset	OFF
State Saved	Saved in instrument state
Initial S/W Revision	A.13.00

## Select Marker

Display a menu with 12 markers available for selection for the current measurement.

Key Path	Marker
Notes	Front panel only. The selected marker is remembered even when not in the Marker menu and is used
Preset	Marker 1
State Saved	Saved in instrument state
Initial S/W Revision	A.13.00

## Normal

Sets the control mode for the selected marker to Normal and turns on the active function for setting its value. If the selected marker was off, it is placed at the center of the screen on the trace specified by the marker's Trace attribute.

A Normal mode (POSition type) marker can be moved to any point on the X Axis by specifying its X Axis value. Its absolute Y Axis value is then the value of the trace point at that X Axis value.

Key Path	Marker
<b>Example</b>	CALC:MON:MARK:MODE POS Sets Marker 1 to Normal.
Couplings	The marker addressed by this command becomes the selected marker on the front panel.
State Saved	Saved in instrument state
Initial S/W Revision	A.13.00

## Delta

Sets the control mode for the selected marker to Delta and turns on the active function for setting its delta value. If the selected marker is off, the marker is placed at the center of the screen on the trace specified by the marker's Trace attribute.

In Delta mode the marker result shows the relative result between the selected (Delta) marker and its reference marker. A delta marker can be moved to any point on the X Axis by specifying its X Axis offset from a reference marker. Its absolute Y Axis value is then the value of the trace point at that X Axis value.

Key Path	Marker
<b>Example</b>	CALC:MON:MARK:MODE DELT Sets marker 1 to Delta.
Dependencies	The marker addressed by this command becomes the selected marker on the front panel.
State Saved	Saved in instrument state
Initial S/W Revision	A.13.00

## Off

Turn off the selected marker. Remove marker annunciation from the display. Turn off any active function. Turning the marker off does not affect which marker is selected.

Key Path	Marker
<b>Example</b>	CALC:MON:MARK:MODE OFF Sets Marker 1 to Off.
State Saved	Saved in instrument state
Initial S/W Revision	A.13.00

## Properties

Accesses a menu that allows you to set marker properties and to access the marker trace menu.

Key Path	Marker
Initial S/W Revision	A.13.00

## Select Marker

Display a menu with 12 markers available for selection for the current measurement.

Key Path	Marker
Notes	Front panel only. The selected marker is remembered even when not in the Marker menu and is used
Preset	Marker 1
State Saved	Saved in instrument state
Initial S/W Revision	A.13.00

## Relative To

Select the reference marker for a marker in Delta mode.

Key Path	Marker, Properties
<b>Remote Command</b>	:CALCulate:MONitor:MARKer[1] 2 ... 12:REFerence <integer> :CALCulate:MONitor:MARKer[1] 2 ... 12:REFerence?
<b>Example</b>	CALC:MON:MARK5:REF 1 CALC:MON:MARK5:REF?
Notes	A marker cannot be relative to itself so that choice is grayed out, and if sent from SCPI, generates error -221: "Settings conflict; marker cannot be relative to itself." When queried, a single value will be returned - the specified marker number's relative marker.
Preset	2 3 4 5 6 7 8 9 10 11 12 1
State Saved	Saved in instrument state
Min	1
Max	12
Initial S/W Revision	A.13.00

## Marker Trace

Assign the specified marker to the designated trace.

Key Path	Marker, Properties
<b>Remote Command</b>	:CALCulate:MONitor:MARKer[1] 2 ... 12:TRACe 1 2 3 4 5 6 :CALCulate:MONitor:MARKer[1] 2 ... 12:TRACe?
<b>Example</b>	CALC:MON:MARK1:TRAC 2 places marker 1 on trace 2.
Notes	A marker may be placed on a blanked and/or inactive trace, even though the trace is not visible and/or updating. An application may register a trace name to be displayed on the key instead of a trace number. SCPI Remarks: 1 - Trace 1



	2 – Trace 2 3 – Trace 3 4 – Freq Scan Trace 1 5 – Freq Scan Trace 2 6 – Freq Scan Trace 3
Couplings	The state of Marker Trace is not affected by the Auto Couple key. If a Marker Trace is chosen manually, Auto Init goes to Off for that marker. Sending the remote command causes the addressed marker to become selected.
Preset	1
State Saved	The Marker Trace and state of Auto Init for each marker is saved in instrument state.
Readback line	TraceN where N is the trace number to which the marker is currently assigned.
Initial S/W Revision	A.13.00

## Couple Marker

When this function is invoked, moving any marker causes an “equal X Axis movement” of every other marker which is active. By “equal X Axis movement” we mean that the difference between each marker’s X Axis value (in the fundamental x-axis units of the trace that marker is on) is preserved, as is the X Axis value of the marker being moved (in the same fundamental X-axis units).

Key Path	Marker
<b>Remote Command</b>	:CALCulate:MONitor:MARKer:COUPle[:STATe] ON OFF 1 0 :CALCulate:MONitor:MARKer:COUPle[:STATe]?
<b>Example</b>	CALC:MON:MARK:COUP ON CALC:MON:MARK:COUP?
Preset	OFF
State Saved	Saved in instrument state
Initial S/W Revision	A.13.00

## All Markers Off

Turns all markers Off.

Key Path	Marker
<b>Remote Command</b>	:CALCulate:MONitor:MARKer:AOFF
<b>Example</b>	:CALC:MON:MARK:AOFF
Couplings	sets the selected marker to 1.
Initial S/W Revision	A.13.00

### Normal Marker State (Remote Command Only)

Toggles the Normal marker state on and off.

<b>Remote Command</b>	:CALCulate[1] 2:MARKer[1] 2 ... 4[:STATe] ON OFF 1 0 :CALCulate[1] 2:MARKer[1] 2 ... 4[:STATe]?
<b>Example</b>	CALC:MARK4 ON Turn on maker 4 in Normal mode.
<b>Notes</b>	This SCPI is Meas Local and Context Sensitive. This SCPI alias to :CALC:MON:MARK[1]]2 3 4:MODE POS.
<b>Preset</b>	OFF
<b>Initial S/W Revision</b>	A.13.00

### Normal Marker X Axis Value (Remote Command Only)

Sets the selected marker to Normal mode, and sets/ gets the marker X Axis Values.

<b>Remote Command</b>	:CALCulate[1] 2:MARKer[1] 2 ... 4:X <value> :CALCulate[1] 2:MARKer[1] 2 ... 4:X?
<b>Example</b>	CALC:MARK3:X 3e4 Turn on maker 3 in Normal mode, set the marker frequency to 30 kHz. CALC:MARK3:X? Turn on maker 3 in Normal mode and query the X axis value.
<b>Notes</b>	This SCPI is Meas Local and Context Sensitive. This SCPI alias to :CALC:MON:MARK[1]]2 3 4:MODE POS; :CALC:MON:MARK[1]]2 3 4:X?
<b>Preset</b>	9.91E+37
<b>Initial S/W Revision</b>	A.13.00

### Normal Marker Y Axis Value (Remote Command Only)

Sets the selected marker to Normal mode, and returns the marker Y Axis Values.

<b>Remote Command</b>	:CALCulate[1] 2:MARKer[1] 2 ... 4:Y?
<b>Example</b>	CALC:MARK3:Y? Turn on maker 3 in Normal mode and query the Y axis value.
<b>Notes</b>	This SCPI is Meas Local and Context Sensitive. This SCPI alias to :CALC:MON:MARK[1]]2 3 4:MODE POS; :CALC:MON:MARK[1]]2 3 4:Y?
<b>Initial S/W Revision</b>	A.13.00

### Delta Marker State (Remote Command Only)

Toggles the Delta marker state on and off.

<b>Remote Command</b>	:CALCulate[1] 2:DELTamarker[1] 2 ... 4[:STATe] ON OFF 1 0 :CALCulate[1] 2:DELTamarker[1] 2 ... 4[:STATe]?
<b>Example</b>	CALC:DELT3 ON Turn on maker 3 in Delta mode.

Notes	This SCPI is Meas Local and Context Sensitive. This SCPI alias to :CALC:MON:MARK[1][2 3 4]:MODE DELT.
Preset	OFF
Initial S/W Revision	A.13.00

### Delta Marker X Axis Value (Remote Command Only)

Sets the selected marker to Delta mode, and sets/ gets the marker X Axis Values. The command input is in relative values and refers to the reference marker while the query always returns absolute values in order to make it compatible with ESU.

<b>Remote Command</b>	:CALCulate[1] 2:DELTaMarker[1] 2 ... 4:X <value> :CALCulate[1] 2:DELTaMarker[1] 2 ... 4:X?
<b>Example</b>	CALC:DELT3:X 3e4 Turn on maker 3 in Delta mode, set the relative delta marker frequency to 30 kHz. CALC:DELT3:X? Turn on maker 3 in Delta mode and query the absolutes X axis value.
Notes	This SCPI is Meas Local and Context Sensitive. This SCPI alias to :CALC:MON:MARK[1][2 3 4]:MODE DELT; followed by query of absolutes X Axis unit. The query is different from :CALC:MON:MARK[1][2 3 4]:X? which returns the relative X Axis unit when marker in Delta mode.
Preset	0
Initial S/W Revision	A.13.00

### Delta Marker Y Axis Value (Remote Command Only)

Sets the selected marker to Delta mode, and returns the marker Y Axis Values. The output is always a relative value referenced to reference marker.

<b>Remote Command</b>	:CALCulate[1] 2:DELTaMarker[1] 2 ... 4:Y?
<b>Example</b>	CALC:DELT3:Y? Turn on maker 3 in Normal mode and query the Y axis relative value.
Notes	This SCPI is Meas Local and Context Sensitive. This SCPI alias to :CALC:MON:MARK[1][2 3 4]:MODE DELT;:CALC:MON:MARK[1][2 3 4]:Y?
Initial S/W Revision	A.13.00

### Marker X Axis Value (Remote Command Only)

Sets the marker X Axis (Frequency) value. It has no effect if the control mode is Off, but is the SCPI equivalent of entering an X value, if the control mode is Normal or Delta.

<b>Key Path</b>	Marker, Select Marker
<b>Remote Command</b>	:CALCulate:MONitor:MARKer[1] 2 ... 12:X <real> :CALCulate:MONitor:MARKer[1] 2 ... 12:X?

<b>Example</b>	CALC:MON:MARK3:X 0 CALC:MON:MARK3:X?
<b>Notes</b>	If no suffix is sent, it will use the fundamental units for the current marker X Axis Scale. If a suffix is sent that does not match the current marker X Axis Scale unit, an "Invalid suffix" error will be generated.  The query returns the marker's absolute X Axis value if the control mode is Normal, or the offset from the marker's reference marker, if the control mode is Delta. The query is returned in the fundamental units for the current marker X Axis scale: seconds. If the marker is off the response is not a number (NAN).
<b>Preset</b>	0
<b>State Saved</b>	No
<b>Min</b>	Current start frequency
<b>Max</b>	Current stop frequency
<b>Initial S/W Revision</b>	A.13.00

### Marker Y Axis Value ( Remote Command Only )

Returns the marker Y Axis value in the current marker Y Axis unit.

<b>Remote Command</b>	:CALCulate:MONitor:MARKer[1] 2 ... 12:Y?
<b>Example</b>	CALC:MON:MARK11:Y?
<b>Notes</b>	The query returns the marker Y-axis result. If the marker is Off the response is not a number (NAN).
<b>State Saved</b>	No
<b>Initial S/W Revision</b>	A.13.00

## Marker Function

There is no Marker Function functionality in this measurement. If this key is pressed, it brings up a blank menu.

---

Key Path	Front-panel key
Initial S/W Revision	A.13.00

---

## Marker->

Displays a menu that enables you to access the Marker To function.

Key Path	Front-panel key
Initial S/W Revision	A.13.00

## Mkr->CF

Sets the Center Freq to the current value of the selected Marker.

Key Path	Marker ->
<b>Remote Command</b>	:CALCulate:MONitor:MARKer[1] 2 ... 12[:SET]:CENTer
<b>Example</b>	CALC:MON:MARK2:CENT
Initial S/W Revision	A.13.00

## Meas

The information in this section is common to all measurements. For key and remote command information for a specific measurement, refer to the section that describes the measurement of interest.

Measurements available under the Meas key are specific to the current Mode.

When viewing Help for measurements, note the following:

**NOTE**

Operation for some keys differs between measurements. The information displayed in Help pertains to the current measurement. To see how a key operates in a different measurement, exit Help (press the Cancel Esc key), select the measurement, then reenter Help (press the Help key) and press that key.

---

Key Path	Front-panel key
Initial S/W Revision	Prior to A.02.00

---

### Remote Measurement Functions

This section contains the following topics:

"Measurement Group of Commands" on page 1048

"Current Measurement Query (Remote Command Only)" on page 1050

"Limit Test Current Results (Remote Command Only)" on page 1050

"Data Query (Remote Command Only)" on page 1050

"Calculate/Compress Trace Data Query (Remote Command Only)" on page 1051

"Calculate Peaks of Trace Data (Remote Command Only)" on page 1056

Hardware-Accelerated Fast Power Measurement (Remote Command Only)

"Format Data: Numeric Data (Remote Command Only)" on page 1057

"Format Data: Byte Order (Remote Command Only)" on page 1058

---

Initial S/W Revision	Prior to A.02.00
----------------------	------------------

---

## Measurement Group of Commands

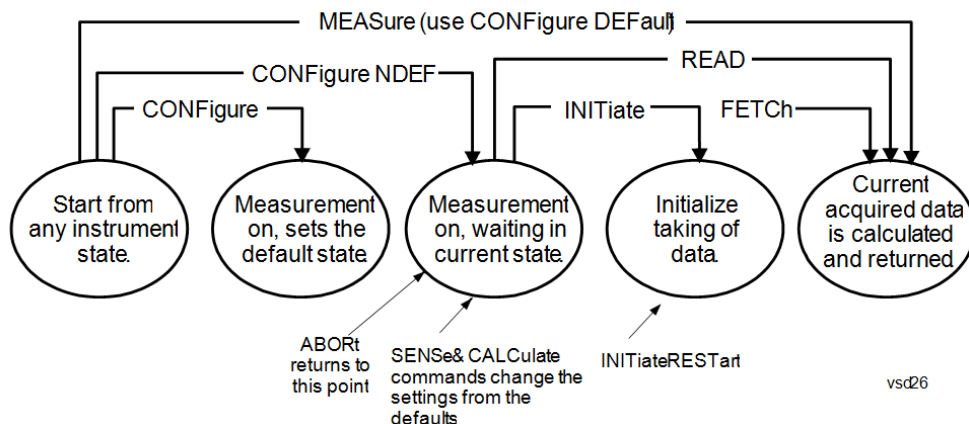

---

### Measure Commands:

:MEASure:<measurement>[n]?

This is a fast single-command way to make a measurement using the factory default instrument settings. These are the settings and units that conform to the Mode Setup settings (e.g. radio standard) that you have currently selected.

- Stops the current measurement (if any) and sets up the instrument for the specified measurement using the factory defaults
- Initiates the data acquisition for the measurement
- Blocks other SCPI communication, waiting until the measurement is complete before returning results.
- If the function does averaging, it is turned on and the number of averages is set to 10.
- After the data is valid it returns the scalar results, or the trace data, for the specified measurement. The type of data returned may be defined by an [n] value that is sent with the command.
- The scalar measurement results will be returned if the optional [n] value is not included, or is set to 1. If the [n] value is set to a value other than 1, the selected trace data results will be returned. See each command for details of what types of scalar results or trace data results are available.
- ASCII is the default format for the data output. (Older versions of Spectrum Analysis and Phase Noise mode measurements only use ASCII.) The binary data formats should be used for handling large blocks of data since they are smaller and faster than the ASCII format. Refer to the FORMat:DATA command for more information.

If you need to change some of the measurement parameters from the factory default settings you can set up the measurement with the CONFIgure command. Use the commands in the SENSe:<measurement> and CALCulate:<measurement> subsystems to change the settings. Then you can use the READ? command to initiate the measurement and query the results.

If you need to repeatedly make a given measurement with settings other than the factory defaults, you can use the commands in the SENSe:<measurement> and CALCulate:<measurement> subsystems to set up the measurement. Then use the READ? command to initiate the measurement and query results.

Measurement settings persist if you initiate a different measurement and then return to a previous one. Use READ:<measurement>? if you want to use those persistent settings. If you want to go back to the default settings, use MEASure:<measurement>?.

---

### Configure Commands:

:CONFIgure:<measurement>

This command stops the current measurement (if any) and sets up the instrument for the specified measurement using

---



---

the factory default instrument settings. It does not initiate the taking of measurement data unless INIT:CONTInuous is ON. If you change any measurement settings after using the CONFigure command, the READ command can be used to initiate a measurement without changing the settings back to their defaults.

In the Swept SA measurement in Spectrum Analyzer mode the CONFigure command also turns the averaging function on and sets the number of averages to 10 for all measurements.

:CONFigure: <measurement>: NDEFault stops the current measurement and changes to the specified measurement. It does not change the settings to the defaults. It does not initiate the taking of measurement data unless INIT:CONTInuous is ON.

The CONFigure? query returns the current measurement name.

The CONFigure:CATalog? query returns a quoted string of all licensed measurement names in the current mode. For example, "SAN, CHP, OBW, ACP, PST, TXP, SPUR, SEM, LIST".

---

#### Fetch Commands:

---

:FETCh:<measurement>[n]?

This command puts selected data from the most recent measurement into the output buffer. Use FETCh if you have already made a good measurement and you want to return several types of data (different [n] values, for example, both scalars and trace data) from a single measurement. FETCh saves you the time of re-making the measurement. You can only FETCh results from the measurement that is currently active, it will not change to a different measurement. An error message is reported if a measurement other than the current one is specified.

If you need to get new measurement data, use the READ command, which is equivalent to an INITiate followed by a FETCh.

The scalar measurement results will be returned if the optional [n] value is not included, or is set to 1. If the [n] value is set to a value other than 1, the selected trace data results will be returned. See each command for details of what types of scalar results or trace data results are available. The binary data formats should be used for handling large blocks of data since they are smaller and transfer faster than the ASCII format. (FORMat:DATA)

FETCh may be used to return results other than those specified with the original READ or MEASure command that you sent.

---

#### INITiate Commands:

---

:INITiate:<measurement>

This command is not available for measurements in all the instrument modes:

- Initiates a trigger cycle for the specified measurement, but does not output any data. You must then use the FETCh<meas> command to return data. If a measurement other than the current one is specified, the instrument will switch to that measurement and then initiate it.
  - For example, suppose you have previously initiated the ACP measurement, but now you are running the channel power measurement. If you send INIT:ACP? it will change from channel power to ACP and will initiate an ACP measurement.
  - Does not change any of the measurement settings. For example, if you have previously started the ACP measurement and you send INIT:ACP? it will initiate a new ACP measurement using the same instrument settings as the last time ACP was run.
  - If your selected measurement is currently active (in the idle state) it triggers the measurement, assuming the trigger conditions are met. Then it completes one trigger cycle. Depending upon the measurement and the number of averages, there may be multiple data acquisitions, with multiple trigger events, for one full trigger cycle. It also holds off additional commands on GPIB until the acquisition is complete.
- 

#### READ Commands:

---

:READ:<measurement>[n]?

- Does not preset the measurement to the factory default settings. For example, if you have previously initiated the ACP
-

---

measurement and you send READ:ACP? it will initiate a new measurement using the same instrument settings.

- Initiates the measurement and puts valid data into the output buffer. If a measurement other than the current one is specified, the instrument will switch to that measurement before it initiates the measurement and returns results.
  - For example, suppose you have previously initiated the ACP measurement, but now you are running the channel power measurement. Then you send READ:ACP? It will change from channel power back to ACP and, using the previous ACP settings, will initiate the measurement and return results.
  - Blocks other SCPI communication, waiting until the measurement is complete before returning the results
  - If the optional [n] value is not included, or is set to 1, the scalar measurement results will be returned. If the [n] value is set to a value other than 1, the selected trace data results will be returned. See each command for details of what types of scalar results or trace data results are available. The binary data formats should be used when handling large blocks of data since they are smaller and faster than the ASCII format. (FORMat:DATA)
- 

---

Initial S/W Revision	Prior to A.02.00
----------------------	------------------

---

### Current Measurement Query (Remote Command Only)

This command returns the name of the measurement that is currently running.

---

<b>Remote Command</b>	:CONFigure?
-----------------------	-------------

<b>Example</b>	CONF?
----------------	-------

Initial S/W Revision	Prior to A.02.00
----------------------	------------------

---

### Limit Test Current Results (Remote Command Only)

Queries the status of the current measurement limit testing. It returns a 0 if the measured results pass when compared with the current limits. It returns a 1 if the measured results fail any limit tests.

---

<b>Remote Command</b>	:CALCulate:CLIMits:FAIL?
-----------------------	--------------------------

<b>Example</b>	CALC:CLIM:FAIL? queries the current measurement to see if it fails the defined limits. Returns a 0 or 1: 0 it passes, 1 it fails.
----------------	--

Initial S/W Revision	Prior to A.02.00
----------------------	------------------

---

### Data Query (Remote Command Only)

Returns the designated measurement data for the currently selected measurement and subopcode.

n = any valid subopcode for the current measurement. See the measurement command results table for your current measurement, for information about what data is returned for the subopcodes.

This command uses the data setting specified by the FORMat:BORDER and FORMat:DATA commands and can return real or ASCII data. (See the format command descriptions under Input/Output in the Analyzer Setup section.)

<b>Remote Command</b>	:CALCulate:DATA[n]?
<b>Notes</b>	The return trace depends on the measurement. In CALCulate:<meas>:DATA[n], n is any valid subopcode for the current measurement. It returns the same data as the FETCH:<measurement>? query where <measurement> is the current measurement.
<b>Initial S/W Revision</b>	Prior to A.02.00

### Calculate/Compress Trace Data Query (Remote Command Only)

Returns compressed data for the currently selected measurement and sub-opcode [n].

n = any valid sub-opcode for that measurement. See the MEASure:<measurement>? command description of your specific measurement for information on the data that can be returned.

The data is returned in the current Y Axis Unit of the analyzer. The command is used with a sub-opcode <n> (default=1) to specify the trace. With trace queries, it is best if the analyzer is not sweeping during the query. Therefore, it is generally advisable to be in Single Sweep, or Update=Off.

This command is used to compress or decimate a long trace to extract and return only the desired data. A typical example would be to acquire N frames of GSM data and return the mean power of the first burst in each frame. The command can also be used to identify the best curve fit for the data.

<b>Remote Command</b>	:CALCulate:DATA<n>:COMPRESS? BLOCK   CFIT   MAXimum   MINimum   MEAN   DMEan   RMS   RMSCubed   SAMPLE   SDEVIation   PPHase [,<soffset> [,<length>[,<roffset>[,<rlimit>]]]]
<b>Example</b>	To query the mean power of a set of GSM bursts: Supply a signal that is a set of GSM bursts. Select the IQ Waveform measurement (in IQ Analyzer Mode). Set the sweep time to acquire at least one burst. Set the triggers such that acquisition happens at a known position relative to a burst. Then query the mean burst levels using, CALC:DATA2:COMP? MEAN, 24e-6, 526e-6 (These parameter values correspond to GSM signals, where 526e-6 is the length of the burst in the slot and you just want 1 burst.)
<b>Notes</b>	The command supports 5 parameters. Note that the last 4 (<soffset>, <length>, <roffset>, <rlimit>) are optional. But these optional parameters must be entered in the specified order. For example, if you want to specify <length>, then you must also specify <soffset>. See details below for a definition of each of these parameters. This command uses the data in the format specified by FORMat:DATA, returning either binary or ASCII data.
<b>Initial S/W Revision</b>	Prior to A.02.00

- BLOCK or block data - returns all the data points from the region of the trace data that you specify. For example, it could be used to return the data points of an input signal over several timeslots, excluding the portions of the trace data that you do not want. (This is x,y pairs for trace data and I,Q pairs for complex data.)

- CFIT or curve fit - applies curve fitting routines to the data. <soffset> and <length> are required to define the data that you want. <roffset> is an optional parameter for the desired order of the curve equation. The query will return the following values: the x-offset (in seconds) and the curve coefficients ((order + 1) values).

MIN, MAX, MEAN, DME, RMS, RMSC, SAMP, SDEV and PPH return one data value for each specified region (or <length>) of trace data, for as many regions as possible until you run out of trace data (using <roffset> to specify regions). Or they return the number of regions you specify (using <rlimit>) ignoring any data beyond that.

- MINimum - returns the minimum data point (y value) for the specified region(s) of trace data. For I/Q trace data, the minimum magnitude of the I/Q pairs is returned.
- MAXimum - returns the maximum data point (y value) for the specified region(s) of trace data. For I/Q trace data, the maximum magnitude of the I/Q pairs is returned.
- MEAN - returns a single value that is the arithmetic mean of the data point values (in dB/ dBm) for the specified region(s) of trace data. For I/Q trace data, the mean of the magnitudes of the I/Q pairs is returned. See the following equations.

- 

**NOTE**

If the original trace data is in dB, this function returns the arithmetic mean of those log values, not log of the mean power which is a more useful value. The mean of the log is the better measurement technique when measuring CW signals in the presence of noise. The mean of the power, expressed in dB, is useful in power measurements such as Channel Power. To achieve the mean of the power, use the RMS option.

Equation 1

Mean Value of Data Points for Specified Region(s)

$$MEAN = \frac{1}{n} \sum_{X_i \in \text{region}(s)} X_i$$

where  $X_i$  is a data point value, and  $n$  is the number of data points in the specified region(s).

Equation 2

Mean Value of I/Q Data Pairs for Specified Region(s)

$$MEAN = \frac{1}{n} \sum_{X_i \in \text{region}(s)} |X_i|$$

where  $|X_i|$  is the magnitude of an I/Q pair, and  $n$  is the number of I/Q pairs in the specified region(s).

- DMEan - returns a single value that is the mean power (in dB/ dBm) of the data point values for the specified region(s) of trace data. See the following equation:

Equation 3

DMEan Value of Data Points for Specified Region(s)

$$\text{DME} = 10 \times \log_{10} \left( \frac{1}{n} \sum_{X_i \in \text{region}(s)} 10^{\frac{X_i}{10}} \right)$$

- RMS - returns a single value that is the average power on a root-mean-squared voltage scale (arithmetic rms) of the data point values for the specified region(s) of trace data. See the following equation.

**NOTE** For I/Q trace data, the rms of the magnitudes of the I/Q pairs is returned. See the following equation. This function is very useful for I/Q trace data. However, if the original trace data is in dB, this function returns the rms of the log values which is not usually needed.

Equation 4

RMS Value of Data Points for Specified Region(s)

$$\text{RMS} = \sqrt{\frac{1}{n} \sum_{X_i \in \text{region}(s)} X_i^2}$$

where  $X_i$  is a data point value, and  $n$  is the number of data points in the specified region(s).

Equation 5

RMS Value of I/Q Data Pairs for Specified Region(s)

$$\text{RMS} = \sqrt{\frac{1}{n} \sum_{X_i \in \text{region}(s)} X_i X_i^*}$$

where  $X_i$  is the complex value representation of an I/Q pair,  $X_i^*$  its conjugate complex number, and  $n$  is the number of I/Q pairs in the specified region(s).

Once you have the rms value for a region of trace data (linear or I/Q), you may want to calculate the mean power. You must convert this rms value (peak volts) to power in dBm:

$$10 \times \log[10 \times (\text{rms value})^2]$$

- SAMPLe - returns the first data value (x,y pair) for the specified region(s) of trace data. For I/Q trace data, the first I/Q pair is returned.
- SDEViation - returns a single value that is the arithmetic standard deviation for the data point values for the specified region(s) of trace data. See the following equation.
- For I/Q trace data, the standard deviation of the magnitudes of the I/Q pairs is returned. See the following equation.

Equation 6

Standard Deviation of Data Point Values for Specified Region(s)

$$\text{SDEV} = \sqrt{\frac{1}{n} \sum_{X_i \in \text{region}(s)} (X_i - \bar{X})^2}$$

where  $X_i$  is a data point value,  $\bar{X}$  is the arithmetic mean of the data point values for the specified region (s), and  $n$  is the number of data points in the specified region(s).

$$\text{SDEV} = \sqrt{\frac{1}{n} \sum_{X_i \in \text{region}(s)} (|X_i| - \bar{X})^2}$$

where  $|X_i|$  is the magnitude of an I/Q pair,  $\bar{X}$  is the mean of the magnitudes for the specified region(s), and  $n$  is the number of data points in the specified region(s).

- PPHase - returns the x,y pairs of both rms power (dBm) and arithmetic mean phase (radian) for every specified region and frequency offset (Hz). The number of pairs is defined by the specified number of regions. This parameter can be used for I/Q vector ( $n=0$ ) in Waveform (time domain) measurement and all parameters are specified by data point in PPHase.

The rms power of the specified region may be expressed as:

$$\text{Power} = 10 \times \log [10 \times (\text{RMS I/Q value})] + 10.$$

The RMS I/Q value (peak volts) is:

$$\sqrt{\frac{1}{n} \sum_{X_i \in \text{region}} X_i X_i^*}$$

where  $X_i$  is the complex value representation of an I/Q pair,  $X_i^*$  its conjugate complex number, and  $n$  is the number of I/Q pairs in the specified region.

The arithmetic mean phase of the specified region may be expressed as:

$$\frac{1}{n} \sum_{Y_i \in \text{region}} Y_i$$

where  $Y_i$  is the unwrapped phase of I/Q pair with applying frequency correction and  $n$  is the number of I/Q pairs in the specified region.

The frequency correction is made by the frequency offset calculated by the arithmetic mean of every specified region's frequency offset. Each frequency offset is calculated by the least square method against the unwrapped phase of I/Q pair.

Sample Trace Data - Constant Envelope

(See below for explanation of variables.)

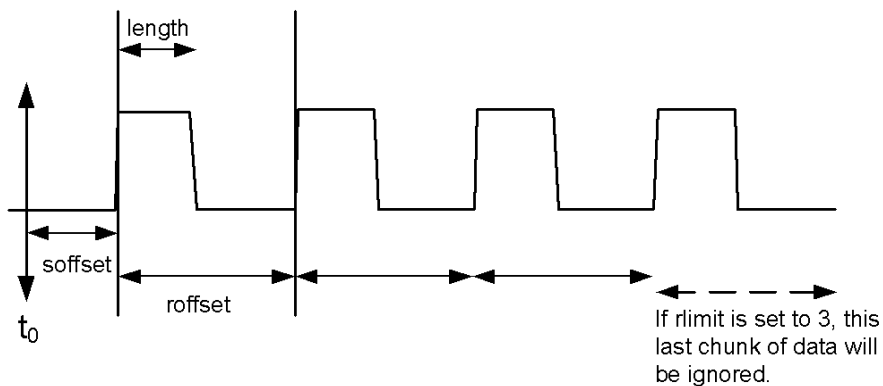

### Sample Trace Data - Not Constant Envelope

(See below for explanation of variables.)

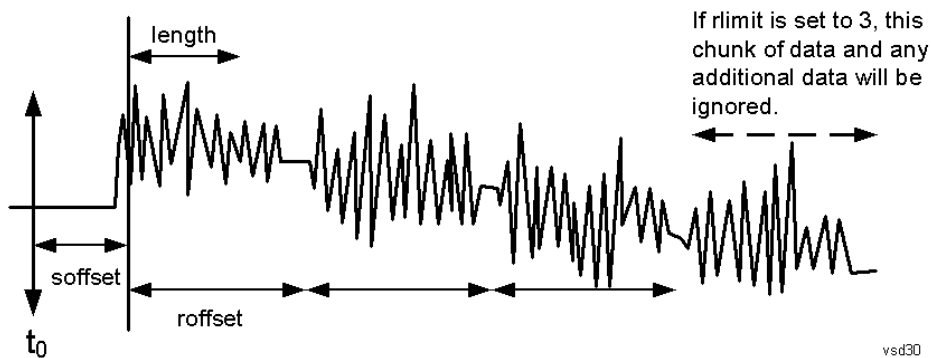

<soffset> - start offset is an optional real number. (It is in seconds for time-domain traces, and is a dimensionless index 0 to Npoints - 1, for frequency-domain traces). It specifies the amount of data at the beginning of the trace that will be ignored before the decimation process starts. It is the time or frequency change from the start of the trace to the point where you want to start using the data. The default value is zero.

<length> - is an optional real number. (It is in seconds for time-domain traces, and is a dimensionless index 0 to Npoints - 1, for frequency-domain traces). It defines how much data will be compressed into one value. This parameter has a default value equal to the current trace length.

<roffset> - repeat offset is an optional real number. (It is in seconds for time-domain traces, and is a dimensionless index 0 to Npoints - 1, for frequency-domain traces). It defines the beginning of the next field of trace elements to be compressed. This is relative to the beginning of the previous field. This parameter has a default value equal to the <length> variable. Note that this parameter is used for a completely different purpose when curve fitting (see CFIT above).

<rlimit> - repeat limit is an optional integer. It specifies the number of data items that you want returned. It will ignore any additional items beyond that number. You can use the Start offset and the Repeat limit to pick out exactly what part of the data you want to use. The default value is all the data.

## Calculate Peaks of Trace Data (Remote Command Only)

Returns a list of all the peaks for the currently selected measurement and sub-opcode [n]. The peaks must meet the requirements of the peak threshold and excursion values.

n = any valid sub-opcode for the current measurement. See the MEASure:<measurement> command description of your specific measurement for information on the data that can be returned.

The command can only be used with specific sub-opcodes with measurement results that are trace data. Both real and complex traces can be searched, but complex traces are converted to magnitude in dBm. In many measurements the sub-opcode n=0, is the raw trace data which cannot be searched for peaks. And Sub-opcode n=1, is often calculated results values which also cannot be searched for peaks.

This command uses the data setting specified by the FORMat:BORDER and FORMat:DATA commands and can return real or ASCII data. If the format is set to INT,32, it returns REAL,32 data.

The command has four types of parameters:

- Threshold (in dBm)
- Excursion (in dB)
- Sorting order (amplitude, frequency, time)
- Optional in some measurements: Display line use (all, > display line, < display line)

---

<b>Remote Command</b>	<p>For Swept SA measurement:</p> <pre>:CALCulate:DATA[1] 2 ... 6:PEAKs? &lt;threshold&gt;,&lt;excursion&gt;[,AMPLitude   FREQuency   TIME[,ALL   GTDLLine   LTDLine]]</pre> <p>For most other measurements:</p> <pre>:CALCulate:DATA[1] 2 ... 6:PEAKs? &lt;threshold&gt;,&lt;excursion&gt;[,AMPLitude   FREQuency   TIME]</pre>
-----------------------	---

---

<b>Example</b>	<p>Example for Swept SA measurement in Spectrum Analyzer Mode:</p> <p>CALC:DATA4:PEAK? -40, 10, FREQ, GTDL This will identify the peaks of trace 4 that are above -40 dBm, with excursions of at least 10 dB. The peaks are returned in order of increasing frequency, starting with the lowest frequency. Only the peaks that are above the display line are returned.</p> <p>Query Results 1:</p> <p>With FORMat:DATA REAL, 32 selected, it returns a list of floating-point numbers. The first value in the list is the number of peak points that are in the following list. A peak point consists of two values: a peak amplitude followed by its corresponding frequency (or time).</p> <p>If no peaks are found the peak list will consist of only the number of peaks, (0).</p>
----------------	---

---

<b>Notes</b>	<p>&lt;n&gt; - is the trace that will be used</p> <p>&lt;threshold&gt; - is the level below which trace data peaks are ignored. Note that the threshold value is required and is always used as a peak criterion. To effectively disable the threshold criterion for this command, provide a substantially low threshold value such as -200 dBm. Also note that the threshold value used in this command is independent of and has no effect on the threshold value stored under the Peak Criteria menu.</p> <p>&lt;excursion&gt; - is the minimum amplitude variation (rise and fall) required for a signal to be identified as peak. Note that the excursion value is required and is always used as a peak criterion. To effectively disable the excursion criterion for this command, provide the minimum value of 0.0 dB. Also note that the excursion value used in this command is independent of and has no effect on the</p>
--------------	---

---



excursion value stored under the Peak Criteria menu.

Values must be provided for threshold and excursion. The sorting and display line parameters are optional (defaults are AMPLitude and ALL).

Note that there is always a Y-axis value for the display line, regardless of whether the display line state is on or off. It is the current Y-axis value of the display line which is used by this command to determine whether a peak should be reported

Sorting order:

AMPLitude - lists the peaks in order of descending amplitude, with the highest peak first (default if optional parameter not sent)

FREQUency - lists the peaks in order of occurrence, left to right across the x-axis.

TIME - lists the peaks in order of occurrence, left to right across the x-axis.

Peaks vs. Display Line:

ALL - lists all of the peaks found (default if optional parameter not sent).

GTDLine (greater than display line) - lists all of the peaks found above the display line.

LTDLine (less than display line) - lists all of the peaks found below the display line.

---

Initial S/W Revision      Prior to A.02.00

---

### Format Data: Numeric Data (Remote Command Only)

This command specifies the format of the trace data input and output. It specifies the formats used for trace data during data transfer across any remote port. It affects only the data format for setting and querying trace data for the :TRACe[:DATA], TRACe[:DATA]?, :CALCulate:DATA[n]? and FETCh:SANalyzer [n]? commands and queries.

---

**Remote Command**      :FORMat[:TRACe][:DATA] ASCii|INTeger,32|REAL,32 |REAL,64  
:FORMat[:TRACe][:DATA]?

---

**Notes**      The query response is:  
ASCii: ASC,8  
REAL,32: REAL,32  
REAL,64: REAL,64  
INTeger,32: INT,32

When the numeric data format is REAL or ASCii, data is output in the current Y Axis unit. When the data format is INTeger, data is output in units of m dBm (.001 dBm).

The INT,32 format returns binary 32-bit integer values in internal units (m dBm), in a definite length block.

---

**Dependencies**      Sending a data format spec with an invalid number (for example, INT,48) generates no error. The analyzer simply uses the default (8 for ASCii, 32 for INTeger, 32 for REAL).

Sending data to the analyzer which does not conform to the current FORMat specified, results in an error. Sending ASCII data when a definite block is expected generates message -161 "Invalid Block Data" and sending a definite block when ASCII data is expected generates message -121 "Invalid Character in Number".

---

**Preset**      ASCii

---

**Backwards Compatibility Notes**      Note that the INT,32 format is only applicable to the command, TRACe:DATA. This preserves backwards compatibility for the Swept SA measurement. For all other commands/queries which honor FORMat:DATA, if INT,32 is sent the analyzer will behave as though it were set to REAL,32.

---

Initial S/W Revision      Prior to A.02.00

---

The specs for each output type follow:

AScii - Amplitude values are in ASCII, in the current Y Axis Unit, one ASCII character per digit, values separated by commas, each value in the form:

SX.YYYYYEsZZ

Where:

S = sign (+ or -)

X = one digit to left of decimal point

Y = 5 digits to right of decimal point

E = E, exponent header

s = sign of exponent (+ or -)

ZZ = two digit exponent

REAL,32 - Binary 32-bit real values in the current Y Axis Unit, in a definite length block.

REAL,64 - Binary 64-bit real values in the current Y Axis Unit, in a definite length block.

### Format Data: Byte Order (Remote Command Only)

This command selects the binary data byte order for data transfer and other queries. It controls whether binary data is transferred in normal or swapped mode. This command affects only the byte order for setting and querying trace data for the :TRACe[:DATA], TRACe[:DATA]? , :CALCulate:DATA[n]? and FETCh:SANalyzer[n]? commands and queries.

By definition any command that says it uses FORMat:DATA uses any format supported by FORMat:DATA.

The NORMal order is a byte sequence that begins with the most significant byte (MSB) first, and ends with the least significant byte (LSB) last in the sequence: 1|2|3|4. SWAPped order is when the byte sequence begins with the LSB first, and ends with the MSB last in the sequence: 4|3|2|1.

---

**Remote Command** :FORMat:BORDER NORMal | SWAPped

:FORMat:BORDER?

---

**Preset** NORMal

---

**Initial S/W Revision** Prior to A.02.00

---

## Meas Setup

Displays the menu keys that enable you to setup the measurement.

Key Path	Front-panel key
Initial S/W Revision	A.13.00

### Select Signal

Specifies the selected signal. The term “Selected signal” is used throughout this document to specify which signal will be affected by the functions.

Key Path	Meas Setup, Signal List
Notes	Front panel only. When Select Signal is the active function, press UP to go up in the signal list, and press DOWN to go down in the list.
Dependencies	Yes
Couplings	When the signal list is cleared, this value will reset to 0.
Preset	If the signal list is empty, =0 If the signal list is not empty, = number of peaks in signal list table
State Saved	Saved in instrument state
Min	0
Max	Number of peaks in the signal list table.
Initial S/W Revision	A.13.00

### Signal List

The Signal List menu allows you to navigate the Signal List with a subset of the functionality available in the Frequency Scan measurement. For ability to fully manipulate the Signal List, please switch to the Frequency Scan measurement.

Key Path	Meas Setup
Initial S/W Revision	A.13.00

### Select Signal

Specifies the selected signal. The term “Selected signal” is used throughout this document to specify which signal will be affected by the functions.

Key Path	Meas Setup, Signal List
Notes	Front panel only. When Select Signal is the active function, press UP to go up in the signal list, and press DOWN to go down in the list.
Dependencies	Yes

Couplings	When the signal list is cleared, this value will reset to 0.
Preset	If the signal list is empty, =0 If the signal list is not empty, = number of peaks in signal list table
State Saved	Saved in instrument state
Min	0
Max	Number of peaks in the signal list table.
Initial S/W Revision	A.13.00

## Navigate

This menu enables you to navigate through the signal list without using a mouse.

Key Path	Meas Setup, Signal List
Initial S/W Revision	A.13.00

## Page Up

If the signal list fills more than one page, pressing this key moves the signal list up by one page.

Key Path	Meas Setup, Signal List, Navigate
Notes	Front panel only.
Couplings	Page Up
Initial S/W Revision	A.13.00

## Page Down

If the signal list fills more than one page, pressing this key moves the signal list down by one page.

Key Path	Meas Setup, Signal List, Navigate
Notes	Front panel only.
Couplings	Page Up
Status Bits/OPC Dependencies	Page Down
Initial S/W Revision	A.13.00

## Scroll Left

Scroll the signal list to the left.

Key Path	Meas Setup, Signal List, Navigate
Notes	Front panel only.
Dependencies	Scroll Right
Initial S/W Revision	A.13.00

### Scroll Right

Scroll the signal list to the right.

Key Path	Meas Setup, Signal List, Navigate
Notes	Front panel only.
Couplings	Scroll Right
Status Bits/OPC Dependencies	Scroll Right
Initial S/W Revision	A.13.00

### Signal → Meters (Move Meters to Current Signal)

Replace Frequency (Meters) with the frequency of the selected signal.

Key Path	Meas Setup, Signal List, Navigate
<b>Remote Command</b>	:CALCulate:SLIS:SET:METer <integer>
<b>Example</b>	CALC:SLIS:SET:MET 12 Set Freq (Meters) to frequency of Signal #12
Notes	If the signal list contains no data, an error is generated and this function cannot be performed. If the selected signal is not in the list, an error is generated and this function cannot be performed.
Initial S/W Revision	A.13.00

### Mark Signals

This menu enables you to mark signals for further processing. A ticked checkbox appears next to the signal number to distinguish them from unmarked signals.

Key Path	Meas Setup, Signal List
Initial S/W Revision	A.13.00

### Select Signal

Specifies the selected signal. The term “Selected signal” is used throughout this document to specify which signal will be affected by the functions.

Key Path	Meas Setup, Signal List, Mark Signals
Notes	Front panel only.
Dependencies	Yes
Couplings	When the signal list is cleared, this value will reset to 0.
Preset	If the signal list is empty, =0 If the signal list is not empty, = number of peaks in signal list table
State Saved	Saved in instrument state
Min	0
Max	Number of peaks in signal list table.
Initial S/W Revision	A.13.00

### Mark Signal

Marks the selected signal.

Key Path	Meas Setup, Signal List, Mark Signals
<b>Remote Command</b>	:CALCulate:SLIST:MARK:SIGNal <integer>
<b>Example</b>	CALC:SLIS:MARK:SIGN 4 Mark signal #4.
Notes	If the signal list contains no data, an error is generated and this function cannot be performed. If the selected signal is not in the list, an error is generated and this function cannot be performed.
Initial S/W Revision	A.13.00

### Mark Duplicates

This menu enables you to mark the signals that are duplicates. A signal is considered to be a duplicate if it is within the width of the 3 dB RBW value. Signals cannot be duplicate unless they are measured using the same 3 dB RBW.

Key Path	Meas Setup, Signal List, Mark Signals
Initial S/W Revision	A.13.00

### All

Marks all duplicate signals.

Key Path	Meas Setup, Signal List, Mark Signals, Mark Duplicates
<b>Remote Command</b>	:CALCulate:SLIST:MARK:DUPLicates[:ALL]
<b>Example</b>	CALC:SLIS:MARK:DUPL
Notes	If the signal list contains no data, an error is generated and this function cannot be performed.
Initial S/W Revision	A.13.00

### Upper

Marks duplicate signals with higher amplitude.

Key Path	Meas Setup, Signal List, Mark Signals, Mark Duplicates
Remote Command	:CALCulate:SLIS:MARK:DUPL:UPPer
Example	CALC:SLIS:MARK:DUPL:UPP
Notes	If the signal list contains no data, an error is generated and this function cannot be performed.
Initial S/W Revision	A.13.00

### Lower

Marks duplicate signals with lower amplitude.

Key Path	Meas Setup, Signal List, Mark Signals, Mark Duplicates
Remote Command	:CALCulate:SLIS:MARK:DUPL:LOWer
Example	CALC:SLIS:MARK:DUPL:LOW
Notes	If the signal list contains no data, an error is generated and this function cannot be performed.
Initial S/W Revision	A.13.00

### Clear Mark

Clears mark from the selected signal.

Key Path	Meas Setup, Signal List, Mark Signals
Remote Command	:CALCulate:SLIS:MARK:CLEar:SIGNal <integer>
Example	CALC:SLIS:MARK:CLE:SIGN 11 Clear mark from signal #11.
Notes	If the signal list contains no data, an error is generated and this function cannot be performed. If the selected signal is not in the list, an error is generated and this function cannot be performed.
Initial S/W Revision	A.13.00

### Mark All

Marks all signals in the signal list.

Key Path	Meas Setup, Signal List, Mark Signals
Remote Command	:CALCulate:SLIS:MARK:ALL
Example	CALC:SLIS:MARK:ALL
Notes	If the signal list contains no data, an error is generated and this function cannot be performed.
Initial S/W Revision	A.13.00

### Clear All

Clears all the marks from the signal list.

Key Path	Meas Setup, Signal List, Mark Signals
Remote Command	:CALCulate:SLIS:MARK:CLEar:ALL
Example	CALC:SLIS:MARK:CLE:ALL Clear mark from all signals.
Notes	If the signal list contains no data, an error is generated and this function cannot be performed.
Initial S/W Revision	A.13.00

### Delete Signals

This key opens the delete signals option menu.

Key Path	Meas Setup, Signal List
Initial S/W Revision	A.13.00

### Select Signal

Specifies the selected signal. The term “Selected signal” is used throughout this document to specify which signal will be affected by the functions.

Key Path	Meas Setup, Signal List, Delete Signals
Notes	Front panel only.
Dependencies	Yes
Couplings	When the signal list is cleared, this value will reset to 0.
Preset	If the signal list is empty, =0 If the signal list is not empty, = number of peaks in signal list table
State Saved	Saved in instrument state
Min	0
Max	Number of peaks in signal list table.
Initial S/W Revision	A.13.00

### Delete Signal

Deletes the selected signal. If you accessed this function from the front panel, the following message will prompt you for confirmation to delete the selected signal from the signal list.

This will delete the selected signal. Are you sure you want to do this?

Please press Enter or OK to proceed. Press ESC or Cancel to close this dialog.



Key Path	Meas Setup, Signal List, Delete Signals
<b>Remote Command</b>	:CALCulate:SLIS:DElete:SIGNal <integer>
<b>Example</b>	CALC:SLIS:DEL:SIGN 4 Delete signal #4.
Notes	If the signal list contains no data, an error is generated and this function cannot be performed. When signals in the signal list were successfully deleted, an advisory is generated. If the selected signal is not in the list, an error is generated and this function cannot be performed.
Initial S/W Revision	A.13.00

### Delete All

Marks and deletes all signals in the signal list. If you accessed this function from the front panel, the following message will prompt you for confirmation to delete the selected signals from the signal list..

This will delete all signals. Are you sure you want to do this?

Please press Enter or OK to proceed. Press ESC or Cancel to close this dialog.

Key Path	Meas Setup, Signal List, Delete Signals
<b>Remote Command</b>	:CALCulate:SLIS:DElete:ALL
<b>Example</b>	CALC:SLIS:DEL:ALL
Notes	If the signal list contains no data, an error is generated and this function cannot be performed. When signals in the signal list were successfully deleted, an advisory is generated.
Initial S/W Revision	A.13.00

### Delete Marked

Deletes all marked signals in the signal list. If you accessed this function from the front panel, the following message will prompt you for confirmation to delete the selected signals from the signal list.

This will delete the marked signals. Are you sure you want to do this?

Please press Enter or OK to proceed. Press ESC or Cancel to close this dialog.

Key Path	Meas Setup, Signal List, Delete Signals
<b>Remote Command</b>	:CALCulate:SLIS:DElete:MARKed
<b>Example</b>	CALC:SLIS:DEL:MARK
Notes	If the signal list contains no data, an error is generated and this function cannot be performed. If no marked signal is found in the signal list, an error is generated and Delete Marked cannot be performed. When signals in the signal list were successfully deleted, an advisory is generated.
Initial S/W Revision	A.13.00

### Delete Unmarked

Deletes all unmarked signals in the signal list. If you accessed this function from the front panel, the following message will prompt you for confirmation to delete the selected signals from the signal list.

This will delete the unmarked signals. Are you sure you want to do this?

Please press Enter or OK to proceed. Press ESC or Cancel to close this dialog.

<b>Key Path</b>	Meas Setup, Signal List, Delete Signals
<b>Remote Command</b>	:CALCulate:SLIS:DELeTe:UNMarked
<b>Example</b>	CALC:SLIS:DEL:UNM
<b>Notes</b>	If the signal list contains no data, an error is generated and this function cannot be performed. When signals in the signal list were successfully deleted, an advisory is generated.
<b>Initial S/W Revision</b>	A.13.00

### Sort Signals

Specifies how the elements in the signal list will be sorted either based on the frequency, detector amplitude, detector vs. limit delta or time in ascending or descending order. During sorting, an advisory message appears at the message bar, "Sorting signal list by <sorting type selected>...", for example:

Sorting signal list by Frequency...

Sorting signal list by Det 1 Amplitude...

Sorting signal list by Det 3 vs Limit Delta...

Sorting signal list by Det 3 vs TimeStamp...

<b>Key Path</b>	Meas Setup, Signal List, Sort Signals
<b>Remote Command</b>	:CALCulate:SLIS:SORt:TYPE FREQuency DAMPlitude DLDeLta TIME :CALCulate:SLIS:SORt:TYPE?
<b>Example</b>	CALC:SLIS:SORt:TYPE FREQ
<b>Dependencies</b>	Selecting a sorting mode (pressing the key or sending the equivalent SCPI command) will turn on the Auto Sort state, even if that sorting mode was already selected.
<b>Preset</b>	FREQuency
<b>State Saved</b>	Saved in instrument state
<b>Range</b>	By Freq By Detector Amptd By ( Detector By Time
<b>Initial S/W Revision</b>	A.13.00

### By Freq

Specifies that the elements in the signal list will be sorted based on the frequency.

<b>Key Path</b>	Meas Setup, Signal List, Signal List, Sort Signals
-----------------	--

<b>Example</b>	CALC:SLIS:SORT:TYPE FREQ
Initial S/W Revision	A.13.00

### By Detector Amptd

Specifies that the elements in the signal list will be sorted based on the detector amplitude.

Key Path	Meas Setup, Signal List, Sort Signals
<b>Example</b>	CALC:SLIS:SORT:TYPE DAMP
Initial S/W Revision	A.13.00

### By Det Amptd Type

Specifies how the signal list will be sorted based on the detector amplitude type.

Key Path	Meas Setup, Signal List, Sort Signals, By Detector Amplitude
<b>Remote Command</b>	:CALCulate:SLIS:SORT:DAMplitude DET1 DET2 DET3 :CALCulate:SLIS:SORT:DAMplitude ?
<b>Example</b>	CALC:SLIS:SORT:DAMP DET2 CALC:SLIS:SORT:DAMP?
Dependencies	Selecting the detector amplitude type to be sorted (pressing the key or sending the equivalent SCPI command) will turn on the Auto Sort state, even if that detector amplitude type was already selected.
Preset	DET1
State Saved	Saved in instrument state
Range	Detector 1 Detector 2 Detector 3
Initial S/W Revision	A.13.00

### By $\Delta$ Detector

Specifies that the elements in the signal list will be sorted based on the detector vs limit delta.

Key Path	Meas Setup, Signal List, Sort Signals
<b>Example</b>	CALC:SLIS:SORT:DET DLD
Initial S/W Revision	A.13.00

### By $\Delta$ Detector Type

Specifies how the signal list will be sorted based on the detector to limit delta.

Key Path	Meas Setup, Signal List, Sort Signals, By $\Delta$
Remote Command	:CALCulate:SLIS:SORT:DLDelta DET1 DET2 DET3 :CALCulate:SLIS:SORT:DLDelta?
Example	CALC:SLIS:SORT:DLD DET2 CALC:SLIS:SORT:DLD?
Dependencies	Selecting the $\Delta$ Detector type to be sorted (pressing the key or sending the equivalent SCPI command) will turn on the Auto Sort state, even if that $\Delta$ Detector type was already selected.
Preset	DET1
State Saved	Saved in instrument state
Range	Detector 1 Detector 2 Detector 3
Initial S/W Revision	A.13.00

### By Time

Specifies that the elements in the signal list will be sorted based on time.

Key Path	Meas Setup, Signal List, Sort Signals
Example	CALC:SLIS:SORT:TYPE TIME
Initial S/W Revision	A.13.00

### Sort Order

Chooses between ascending and descending order.

Key Path	Meas Setup, Signal List, Sort Signals
Remote Command	:CALCulate:SLIS:SORT:ORder ASCending  DESCending :CALCulate:SLIS:SORT:ORder?
Example	CALC:SLIS:SORT:ORD DESC
Dependencies	Selecting the sort order (pressing the key or sending the equivalent SCPI command) will turn on the Auto Sort state, even if that sort order was already selected.
Preset	ASCending
State Saved	Saved in instrument state
Initial S/W Revision	A.13.00

### Auto Sort

If this is turned on, the measurement will perform signal sorting based on the sorting order and sorting type selected before each new signal is added. Otherwise, the signal will be added into the signal list in descending order of the trace amplitude level.

Key Path	Meas Setup, Signal List, Sort Signals
Remote Command	:CALCulate:SLIS:Sort:AUTO ON OFF 1 0 :CALCulate:SLIS:Sort:AUTO?
Example	CALC:SLIS:Sort:AUTO 1 Turn on auto sorting CALC:SLIS:Sort:AUTO?
Notes	If Scan Sequence is set to Remeasure, signal in the list will only be auto sorted when Remeasure is completed.
Preset	ON
State Saved	Saved in instrument state
Range	On Off
Initial S/W Revision	A.13.00

## Comment

Sets an ASCII comment field for each signal in the list, which will be shown in the “Comment” column of signal list. This value will be stored in signal list exported file.

Key Path	Meas Setup, Signal List
Remote Command	[:SENSe]:SLIS:COMMent <integer>,"string" [:SENSe]:SLIS:COMMent? <integer>
Example	:SLIS:COMM 2, "unknown"
Preset	"" (null String), not affected by Mode Preset, preset by Restore Mode Defaults.
State Saved	Saved in instrument state
Initial S/W Revision	A.13.00

## Limits

Opens the Limit Lines menu that contains keys that control limit lines of the current measurement. Only the upper limit is used in the Monitor Spectrum measurement.

Key Path	Meas Setup
State Saved	Saved in instrument state
Initial S/W Revision	A.13.00

## Select Limit

Specifies the selected limit. The term “selected limit” is used throughout this document to specify which limit will be affected by the functions.

Key Path	Meas Setup, Limits
Notes	Front panel only. The selected limit is remembered even when not in the Limit Menu.
Preset	Limit 1
State Saved	Saved in instrument state
Initial S/W Revision	A.13.00

## Limit On/Off

Selects whether the limit and margin are displayed. If Test Limits is on, this also determines whether the test trace (see ["Test Trace" on page 791](#)) will be tested against the limit. If Limit On/Off is On, the following occurs:

- The limit line is displayed, in the same color, but paler, as the limited trace. Portions of traces that fail the limits will be displayed in red.
- The margin line is displayed if Margin is on and the Margin Value is non-zero (see ["Margin" on page 796](#)). The margin line is displayed in the same color as the limit line, but paler still and dashed. Portions of traces that pass the limits but fail the margin will be displayed in amber.
- The trace is tested for the purpose of the "Trace Pass/Fail" indication in the graticule if, in addition to Limit On/Off being On, the trace is displayed and Test Limits (All Limits) is on (see ["Test Limits \(All Limits\)" on page 801](#)). If the trace is not tested, no report of the trace passing or failing is seen on the graticule. Note that the SCPI queries of Limit Pass/Fail are independent of these conditions. The test is always performed when queried over SCPI.

The PASS/FAIL box in the corner of the Meas Bar is only displayed if there is at least one "Trace Pass/Fail" indication displayed in the graticule.

Note that the red and amber coloring of traces that fail the limits and/or margins only applies to traces whose X-axis corresponds to the current analyzer X-axis. Traces that are not updating (in View, for example) will not change color if the analyzer X-axis settings (e.g., start and stop frequency) do not match those of the trace, for example if they have been changed since the trace stopped updating. In this case, the Invalid Data indicator (\*) will appear in the upper right corner.

When the limits are frequency limits but the trace is a zero-span trace, the limit trace is drawn at the limit amplitude of the center frequency. When the limits are time limits but the trace is a frequency domain trace, the limit trace is drawn according to the current time axis, with the left of the screen being 0 and the right being equal to sweep time.

Key Path	Meas Setup, Limits
<b>Remote Command</b>	:CALCulate:LLINe[1] 2 ... 6:DISPlay ON OFF 1 0 :CALCulate:LLINe[1] 2 ... 6:DISPlay?
<b>Example</b>	CALC:LLIN2:DISP ON CALC:LLIN2:DISP?
<b>Couplings</b>	Limit display ON selects the limit. Testing is done on all displayed limits if Test Limits (All Limits) is ON. Entering the limit menu from the GUI turns on the selected limit.

Preset	OFF
State Saved	Saved in instrument state
Range	On Off
<b>Backwards Compatibility SCPI</b>	:CALCulate[1] 2:LIMit[1] 2 ... 6:STATe
Backwards Compatibility SCPI Notes	This command above is included for ESU compatibility. The suffix [1]2 is irrelevant to the measurement, they are added solely for remote language compatibility.
Initial S/W Revision	A.13.00

## Properties

Accesses a menu that lets you set the properties of the selected limit.

Key Path	Meas Setup, Limits
Initial S/W Revision	A.13.00

## Select Limit

Specifies the selected limit. The term “selected limit” is used throughout this document to specify which limit will be affected by the functions.

Key Path	Meas Setup, Limits
Notes	Front panel only. The selected limit is remembered even when not in the Limit Menu.
Preset	Limit 1, not affected by Mode Preset, preset by Restore Mode Defaults.
State Saved	Saved in instrument state
Initial S/W Revision	A.13.00

## Test Trace

Selects the trace that you want the limit to test. A limit is applied to one and only one trace.

A trace can have multiple limit lines simultaneously; in that case, only one upper limit line will affect the color of the trace. Other limit lines will be displayed, and will affect the pass/fail status, but the trace will not turn red if it crosses a secondary limit line.

Key Path	Meas Setup, Limits, Properties
<b>Remote Command</b>	:CALCulate:LLINe[1] 2 ... 6:TRACe 1 2 3 :CALCulate:LLINe[1] 2 ... 6:TRACe?
<b>Example</b>	CALC:LLIN3:TRAC 2 Applies limit 3 to trace 2.
Notes	When the trace display is off, the trace is not tested. The trace is tested only when the trace display is on and Test Limits (see <a href="#">"Test Limits (All Limits)" on page 801</a> ) is on.

Couplings	This matters when testing a trace or limit line for failure, via :CALC:MON:LLIN3:FAIL? or :CALC:MON:TRAC2:FAIL?
Preset	1 1 2 2 3 3
State Saved	Saved in instrument state
Range	1 2 3
Initial S/W Revision	A.13.00

## Interpolation

Accesses a menu that lets you set the frequency and amplitude interpolation of the selected limit.

Key Path	Meas Setup, Limits, Properties
Readback	In square brackets, the state of Frequency Interpolation then the state of Amplitude Interpolation, separated by commas, as [Lin Frequency, Log Amplitude]
Initial S/W Revision	A.13.00

## Frequency Interpolation

Sets the interpolation between frequency points, allowing you to determine how limit trace values are computed between points in a limit table. The available interpolation modes are linear and logarithmic. If frequency interpolation is logarithmic (Log), frequency values between limit points are computed by first taking the logarithm of both the table values and the intermediate value. A linear interpolation is then performed in this logarithmic frequency space. An exactly analogous manipulation is done for logarithmic amplitude interpolation.

Note that the native representation of amplitude is in dB.

For linear amplitude interpolation and linear frequency interpolation, the interpolation is computed as:

$$y = 20 \log \left( \frac{10^{\frac{y_{i+1}}{20}} - 10^{\frac{y_i}{20}}}{f_{i+1} - f_i} (f - f_i) + 10^{\frac{y_i}{20}} \right)$$

For linear amplitude interpolation and log frequency interpolation, the interpolation is computed as:

$$y = 20 \log \left( \frac{10^{\frac{y_{i+1}}{20}} - 10^{\frac{y_i}{20}}}{\log f_{i+1} - \log f_i} (\log f - \log f_i) + 10^{\frac{y_i}{20}} \right)$$

For log amplitude interpolation and linear frequency interpolation, the interpolation is computed as:

$$y = \frac{y_{i+1} - y_i}{f_{i+1} - f_i} (f - f_i) + y_i$$

For log amplitude interpolation and log frequency interpolation, the interpolation is computed as:



$$y = \frac{y_{i+1} - y_i}{\log f_{i+1} - \log f_i} (\log f - \log f_i) + y_i$$

The Interpolation modes determine how limit values are computed between points in the limit table. The appearance of a limit trace is also affected by the amplitude scale, which may be linear or logarithmic.

Key Path	Meas Setup, Limits, Properties, Interpolation
Remote Command	:CALCulate:LLINE[1] 2 ... 6:CONTRol:INTerpolate:TYPE LOGarithmic   LINear :CALCulate:LLINE[1] 2 ... 6:CONTRol:INTerpolate:TYPE?
Example	CALC:LLIN4:CONT:INT:TYPE LIN Sets limit line 4 frequency interpolation to linear.
Dependencies	This key is grayed out if Time is the selected X Axis Units.
Preset	Linear, not affected by Mode Preset, preset by Restore Mode Defaults.
State Saved	Saved in instrument state
Range	LogLin
Initial S/W Revision	A.13.00

### Amplitude Interpolation

Sets the interpolation to linear or logarithmic for the specified limiting points set, allowing you to determine how limit trace values are computed between points in a limit table. See ["Frequency Interpolation" on page 792](#) for the equations used to calculate limit values between points.

Key Path	Meas Setup, Limits, Properties, Interpolation
Remote Command	:CALCulate:LLINE[1] 2 ... 6:AMPLitude:INTerpolate:TYPE LOGarithmic   LINear :CALCulate:LLINE[1] 2 ... 6:AMPLitude:INTerpolate:TYPE?
Example	CALC:LLIN:AMPL:INT:TYPE LIN Sets limit line 1 amplitude interpolation to linear.
Preset	Linear, not affected by Mode Preset, preset by Restore Mode Defaults.
State Saved	Saved in instrument state
Range	LogLin
Initial S/W Revision	A.13.00

### Fixed/ Relative

Accesses a menu that lets you specify that the selected limit is relative to either the Center Frequency or the Reference level.

Key Path	Meas Setup, Limits, Properties
Readback	[Fixed] – if both Relative to CF and RL set to OFF. [Rel to RL] – if only RL set to ON. [Rel to CF] – if only CF set to ON.

[Rel to CF + RL] – if both Relative to CF and RL set to ON.

Initial S/W Revision      A.13.00

### Relative to CF

Chooses whether the limit line frequency points are coupled to the instrument center frequency, and whether the frequency points are expressed as an offset from the instrument center frequency. If the limit lines are specified with time, this has no effect. The limit table must in this case support negative frequencies.

For example, assume you have a frequency limit line, and the analyzer center frequency is at 1 GHz. If Relative to CF is “Off”, entering a limit line segment with a frequency coordinate of 300 MHz displays the limit line segment at 300 MHz, and the limit line segment will not change frequency if the center frequency changes. If Relative to CF is “On”, entering a limit line segment with a frequency coordinate of 300 MHz displays the limit line segment at CF + 300 MHz, or 1.3 GHz. Furthermore, if the center frequency changes to 2 GHz, the limit line segment will be displayed at CF + 300 MHz, or 2.3 GHz.

It is possible to change this setting after a limit line has been entered. When changing from On to Off or vice-versa, the frequency values in the limit line table change so that the limit line remains in the same position for the current frequency settings of the instrument.

<b>Key Path</b>	Meas Setup, Limits, Properties, Fixed/Relative
<b>Remote Command</b>	:CALCulate:LLINE[1] 2 ... 6:FREQUENCY:CMODE:RELative ON   OFF   1   0 :CALCulate:LLINE[1] 2 ... 6:FREQUENCY:CMODE:RELative?
<b>Example</b>	CALC:LLIN:FREQ:CMOD:REL OFF Makes limit line 1 relative to the Center freq.
<b>Notes</b>	If the Trace Domain is changed to Time (:CALCulate:LLINE:CONTrol:DOMain TIME), the SCPI command : :CALCulate:LLINE[1]]2 3 4 5 6:FREQUENCY:CMODE:RELative ON OFF 1 0 will have no effect.
<b>Couplings</b>	Pressing this button makes Center Frequency the active function.
<b>Preset</b>	Off, not affected by Mode Preset, preset by Restore Mode Defaults.
<b>State Saved</b>	Saved in instrument state
<b>Range</b>	On Off
<b>Initial S/W Revision</b>	A.13.00

### Relative to RL

Chooses whether the limit line amplitude points are coupled to the instrument reference level, and whether the amplitude points are expressed as an offset from the instrument reference level.

For example, assume you have a limit line, and the reference level at –10 dBm. If Relative to RL is “Off”, entering a limit line segment with an amplitude coordinate of –20 dB displays the limit line segment at –20 dBm, and the limit line segment will not change amplitude if the reference level amplitude changes. If Relative to RL is “On”, entering a limit line segment with an amplitude coordinate of –20 dB displays the limit line segment at RL – 20 dB, or –30 dBm. Furthermore, if the reference level amplitude changes to –30 dBm, the limit line segment will be displayed at RL – 20 dB, or –50 dBm.

It is possible to change this setting after a limit line has been entered. When changing from On to Off or vice-versa, the amplitude values in the limit line table change so that the limit line remains in the same position for the current reference level settings of the instrument.

Key Path	Meas Setup, Limits, Properties, Fixed/Relative
Remote Command	:CALCulate:LLINE[1] 2 ... 6:AMPLitude:CMODE:RELative ON   OFF   1   0 :CALCulate:LLINE[1] 2 ... 6:AMPLitude:CMODE:RELative?
Example	CALC:LLIN:AMPL:CMOD:REL ON Makes limit line 1 relative to the reference level amplitude.
Couplings	Pressing this button makes Reference level the active function.
Preset	Off, not affected by Mode Preset, preset by Restore Mode Defaults.
State Saved	Saved in instrument state
Range	On Off
Initial S/W Revision	A.13.00

### Description

Provides a description of up to 60 characters by which you can easily identify the limit. The descriptions will be stored in the exported file and can be displayed in the active function area by selecting them as the active function, if desired to be in a screen dump.

Key Path	Meas Setup, Limits, Properties
Remote Command	:CALCulate:LLINE[1] 2 ... 6:DESCription "string" :CALCulate:LLINE[1] 2 ... 6:DESCription?
Example	CALC:LLIN:DESC "European Emissions"
Preset	"" (null String), not affected by Mode Preset, preset by Restore Mode Defaults.
State Saved	Saved in instrument state
Backwards Compatibility SCPI	:CALCulate[1] 2:LIMit[1] 2 ... 6:NAME
Backwards Compatibility SCPI Notes	The suffix [1]2 is irrelevant to the measurement, they are added solely for remote language compatibility.
Initial S/W Revision	A.13.00

### Comment

Sets an ASCII comment field, which will be stored in an exported file. The comment can be displayed in the active function area by selecting it as the active function, if desired to be in a screen dump. The Limits .csv file supports this field.

Key Path	Meas Setup, Limits, Properties
Remote Command	:CALCulate:LLINE[1] 2 ... 6:COMMeNt "string" :CALCulate:LLINE[1] 2 ... 6:COMMeNt ?

<b>Example</b>	CALC:LLIN:COMM "European Emissions"
Preset	"" (null String), not affected by Mode Preset, preset by Restore Mode Defaults.
State Saved	Saved in instrument state
<b>Backwards Compatibility SCPI</b>	:CALCulate[1] 2:LIMit[1] 2 ... 6:COMMent
Backwards Compatibility SCPI Notes	This command above is included for ESU compatibility. The suffix [1]2 is irrelevant to the measurement, they are added solely for remote language compatibility.
Initial S/W Revision	A.13.00

## Margin

Selects a margin for this limit, which will cause a trace to Fail Margin when the trace is between the limit line and the margin line. Portions of the traces that pass the limit but fail the margin will be displayed in an amber color. .

A margin is always specified in dB relative to a limit. Since there is only an upper limit in the Monitor Spectrum measurement, the margin is always negative. If a value is entered with the incorrect sign, the system will automatically take the negative of the entered value.

When the Margin is selected, it may be turned off by pressing the Margin key until Off is underlined. This may also be done by performing a preset. Margin is the default active function whenever the margin is on, and it is not the active function whenever the margin is off.

The margin lines are displayed in the same color, but paler, as limit lines. If the limited trace is blanked then the limit line and the margin line will be blanked as well.

<b>Key Path</b>	Meas Setup, Limits
<b>Remote Command</b>	:CALCulate:LLINe[1] 2 ... 6:MARGin <rel_amp1> :CALCulate:LLINe[1] 2 ... 6:MARGin? :CALCulate:LLINe[1] 2 ... 6:MARGin:STATe ON OFF 1 0 :CALCulate:LLINe[1] 2 ... 6:MARGin:STATe?
<b>Example</b>	CALC:LLIN6:MARG -4dB Set Limit line 6's margin to -4 dB. CALC:LLIN2:MARG:STAT OFF ! Turns off the margin for limit line 2 and removes any tests associated with that margin line.
Notes	The queries "Limit Line Fail?" :CALCulate:LLINe[1]]2 3 4 5 6:FAIL? will return 1 if the margin fails.
Preset	Not affected by Mode Preset, set to 0 dB for all Limits by Restore Mode Defaults.
State Saved	Saved in instrument state
Min	-40 dB
Max	0 dB
Default Unit	dB
Initial S/W Revision	A.13.00

## Edit Limit

Opens the Table Editor for the selected limit line.

Key Path	Meas Setup
Initial S/W Revision	A.13.00

## Navigate

Lets you move through the table to edit the desired point

Key Path	Meas Setup, Limits, Edit
Notes	There is no value readback on the key
Min	1
Max	2000
Initial S/W Revision	A.13.00

## Frequency

Lets you edit the frequency of the current row.

Key Path	Meas Setup, Limits, Edit
Notes	There is no value readback on the key
Min	0
Max	1 THz
Initial S/W Revision	A.13.00

## Amplitude

Lets you edit the Amplitude of the current row.

Key Path	Meas Setup, Limits, Edit
Notes	There is no value readback on the key
Min	-1000 dBm
Max	1000 dBm
Initial S/W Revision	A.13.00

## Insert Point Below

Pressing this key inserts a point below the current point. The new point is a copy of the current point. And becomes the current point The new point is not yet entered into the underlying table, and the data in the

row is displayed in light gray.

Key Path	Meas Setup, Limits, Edit
Initial S/W Revision	A.13.00

### Delete Point

This is an immediate action key. It will immediately delete the currently selected point, whether or not that point is being edited, and selects Navigate. The point following the currently selected point (or the point preceding if there is none) will be selected.

Key Path	Meas Setup, Limits, Edit
Initial S/W Revision	A.13.00

### Copy from Limit

Copies an existing limit into the current limit, including all secondary parameters (Description, Associated Trace, Type, Margin, Interpolation, Relative to CF/RL).

Key Path	Meas Setup, Limits, Edit
<b>Remote Command</b>	:CALCulate:LLINE[1] 2 ... 6:COPY LLINE1   LLINE2   LLINE3   LLINE4   LLINE5   LLINE6
<b>Example</b>	CALC:LLINE2:COPY LLINE1 Copies the data from limit 1 into limit 2
Notes	Auto return to the Edit menu.
<b>Backwards Compatibility SCPI</b>	:CALCulate[1] 2:LIMit[1] 2 ... 6:COPY
Backwards Compatibility SCPI Notes	This command above is included for ESU compatibility. The suffix [1]2 is irrelevant to the measurement, they are added solely for remote language compatibility.
Initial S/W Revision	A.13.00

### Build From Trace

Builds a limit using an existing trace. This command will overwrite all data in the limit. Since a straight copy would typically have hundreds or thousands of segments, the data will be approximated to better represent a limit line; small excursions whose width is less than 10 trace buckets will sometimes not be captured. Secondary parameters that are not associated with traces (Description, Associated Trace, Type, Margin, Interpolation, Relative to CF/RL) will be unchanged.

When taking a trace to build a limit, it will often work well to take the trace with a resolution bandwidth wider than the expected measurement, a video bandwidth lower than the expected measurement, and with the detector set to Max Hold or Min Hold.

The limit will be built above the trace. If the trace is constant, the limit should pass after being built.

Key Path	Meas Setup, Limits, Edit
<b>Remote Command</b>	:CALCulate:LLINe[1] 2 ... 6:BUILD TRACE1 TRACE2 TRACE3
<b>Example</b>	CALC:LLIN2:BUIL TRACE1 Builds limit line 2 based on the data in trace 1. This will overwrite the data in the table editor.
Notes	Auto return to Edit menu.
Initial S/W Revision	A.13.00

### Offset

Enters a menu that allows you to offset the limit trace by a specified frequency, time, or amplitude. The offsets will be immediately applied to the limit trace for display and failure calculation. The offset can also be applied to the points in the limit line.

Key Path	Meas Setup, Limits, Edit
Initial S/W Revision	A.13.00

### X Offset

Offsets the limit trace by some specified frequency (for Frequency-based limit lines) or a time (for time-based limit lines).

Key Path	Meas Setup, Limits, Edit, Offset
<b>Remote Command</b>	:CALCulate:LLINe[1] 2 ... 6:OFFSet:X <freq> :CALCulate:LLINe[1] 2 ... 6:OFFSet:X?
<b>Example</b>	CALC:LLIN:OFFS:X -50MHZ Sets the X axis offset to -50 MHz. CALC:LLIN:OFFS:UPD Applies the X axis offset to all points in the limit line, then reset the X axis offset to zero.
Preset	0 Hz if Limit X-Axis Unit is Frequency 0 S if Limit X-Axis Unit is Time
State Saved	Saved in instrument state
Min	-500 GHz
Max	500 GHz
Default Unit	Determined by X axis scale.
Initial S/W Revision	A.13.00

### Y Offset

Offsets all segments in the limit line by some specified amplitude.

Key Path	Meas Setup, Limits, Edit, Offset
----------	----------------------------------

<b>Remote Command</b>	:CALCulate:LLINe[1] 2 ... 6:OFFSet:Y <rel_amp1> :CALCulate:LLINe[1] 2 ... 6:OFFSet:Y?
<b>Example</b>	CALC:LLIN:OFFS:Y -3 dB Sets the Y axis offset to -3 dB. CALC:LLIN:OFFS:UPD Applies the Y axis offset to all points in the limit line, then reset the Y axis offset to zero.
Preset	0 dB
State Saved	Saved in instrument state
Min	-9.9E+37
Max	9.9E+37
Default Unit	dB
Initial S/W Revision	A.13.00

### Apply Offset to Limit Table

Adds the X and Y offsets to each point in the limit table, then resets the X and Y offset values to zero. This has no effect on the position of the limit trace.

For example, if the X offset is -10 MHz and the Y offset is 1 dB, the values in the limit table will be updated as follows: 10 MHz will be subtracted from each X value, 1 dB will be added to each Y value. The offset values will then be reset to zero. The limit trace will not be moved and the limit table will be updated to accurately reflect the currently displayed limit trace.

<b>Key Path</b>	Meas Setup, Limits, Edit, Offset
<b>Remote Command</b>	:CALCulate:LLINe[1] 2 ... 6:OFFSet:UPDate
<b>Example</b>	CALC:LLIN3:OFFS:UPD Updates the limit table 3 to reflect the X and Y offsets, then resets the offsets to zero.
Initial S/W Revision	A.13.00

### Scale X Axis

Matches the X Axis to the selected Limit, as close as possible.

For frequency limits and a frequency-domain X-axis, sets the Start and Stop Frequency to contain the minimum and maximum Frequency of the selected Limit. The range between Start Frequency and Stop Frequency is 12.5% above the range between the minimum and maximum Frequency so that the span exceeds this range by one graticule division on either side.

For time limits and a time-domain X-axis, sets the sweep time to match the maximum Time of the selected Limit.

If the domain of the selected limit does not match the domain of the X Axis, no action is taken. Standard clipping rules apply, if the value in the table is outside the allowable range for the X axis.

<b>Key Path</b>	Meas Setup, Limits, Edit
Initial S/W Revision	A.13.00



## Test Limits (All Limits)

Selects whether displayed traces are tested against displayed limits (i.e. those for which Limit On/Off is set to On).

For each displayed trace for which a Limit is turned on, a message will be displayed in the upper-left corner of the graticule to notify whether the trace passes or fails the limits.

If the trace is at or within the bounds of all applicable limits and margins, the text “Trace x Pass” will be displayed in green, where x is the trace number. A separate line is used for each reported trace.

If the trace is at or within the bounds of all applicable limits, but outside the bounds of some applicable margin, the text “Trace x Fail Margin” will be displayed in amber, where x is the trace number. A separate line is used for each reported trace.

If the trace is outside the bounds of some applicable limits, the text “Trace x Fail” will be displayed in red, where x is the trace number. A separate line is used for each reported trace.

If the trace has no enabled limits, or the trace itself is not displayed, no message is displayed for that trace.

The PASS/FAIL box in the corner of the Meas Bar is only displayed if there is at least one “Trace Pass/Fail” indication displayed in the graticule.

If two amplitude values are entered for the same frequency, a single vertical line is the result. In this case, if an upper line is chosen, the lesser amplitude is tested. If a lower line is chosen, the greater amplitude is tested.

This command only affects the display, and has no impact on remote behavior. Limit queries over SCPI test the trace against the limit regardless of whether the trace or the limit is turned on (exception: the query :CALCulate:MONitor:TRACe[1]|2|3|4|5|6:FAIL? tests only the limits that are turned on for that trace).

<b>Key Path</b>	Meas Setup, Limits
<b>Remote Command</b>	:CALCulate:LLINe:TEST ON OFF 1 0 :CALCulate:LLINe:TEST?
<b>Example</b>	CALC:LLIN:TEST ON CALC:LLIN:TEST?
<b>Preset</b>	On, not affected by Mode Preset, preset by Restore Mode Defaults.
<b>State Saved</b>	Saved in instrument state
<b>Range</b>	On Off
<b>Initial S/W Revision</b>	A.13.00

## Delete Limit

Deletes the currently selected limit line. Pressing Delete Limit purges the data from the limit line tables.

Limit data, including secondary parameters such as description, margin value, etc., will be cleared and returned to factory preset settings.

When this key is pressed a prompt is placed on the screen that says “Please press Enter or OK key to delete limit. Press ESC or Cancel to close this dialog.” The deletion is only performed if you press OK or Enter; if so, after the deletion, the informational message “Limit deleted” appears in the MSG line.

<b>Key Path</b>	Meas Setup, Limits
<b>Remote Command</b>	:CALCulate:LLINE[1] 2 ... 6:DElete
<b>Example</b>	CALC:LLIN3:DEL Deletes all data for limit line 3
<b>Backwards Compatibility SCPI</b>	:CALCulate[1] 2:LIMit[1] 2 ... 6:DElete
<b>Backwards Compatibility SCPI Notes</b>	This command above is included for ESU compatibility. The suffix [1]2 is irrelevant to the measurement, they are added solely for remote language compatibility.
<b>Initial S/W Revision</b>	A.13.00

### Delete All Limits

Deletes all limit lines. Pressing Delete All Limits purges the data from all limit line tables.

All limit data will be cleared and returned to factory preset settings.

When this key is pressed a prompt is placed on the screen that says “Please press Enter or OK key to delete all limits. Press ESC or Cancel to close this dialog.” The deletion is only performed if you press OK or Enter. After a deletion, the informational message “All Limits deleted” appears in the MSG line.

<b>Key Path</b>	Meas Setup, Limits
<b>Remote Command</b>	:CALCulate:LLINE:ALL:DElete
<b>Example</b>	CALC:LLIN:ALL:DEL
<b>Initial S/W Revision</b>	A.13.00

### Limit Line Fail? (Remote Command Only)

Tests a limit line against its associated trace. Returns a 0 if the trace is within the limit and margin, a 1 if the trace exceeds either the limit or the margin.

Note that this command only tests one limit line – other limit lines are not tested when executing this command. To see whether a trace passed all limits, use :CALCulate:MONitor:TRACe:FAIL?.

Note that this command performs the test regardless of whether the trace or the limit is turned on, on the display.

<b>Remote Command</b>	:CALCulate:MONitor:LLINE[1] 2 ... 6:FAIL?
<b>Example</b>	CALC:MONitor:LLIN:FAIL? Returns a zero if limit line 1’s associated trace has no failure, 1 if there is a margin or limit failure.
<b>Backwards Compatibility SCPI</b>	:CALCulate[1] 2:LIMit[1] 2 ... 6:FAIL?
<b>Backwards Compatibility</b>	This command above is included for ESU compatibility. The suffix [1]2 is irrelevant to the

SCPI Notes	measurement, they are added solely for remote language compatibility.
Initial S/W Revision	A.13.00

### Trace Fail? (Remote Command Only)

Tests a trace against all associated limit lines. Returns a 0 if the trace is within all limits and margins, a 1 if the trace exceed either the limit or the margin. If no limits apply to the selected trace, this will automatically return a 0.

Only applies to limits that are turned on, if a Limit is off it will not be tested. If a Trace is not displaying it will still be tested, and if Test Limits (All Limits) is off the Trace will still be tested.

This command ignores limit lines that are assigned to other traces.

<b>Remote Command</b>	:CALCulate:MONitor:TRACe[1] 2 3:FAIL?
<b>Example</b>	CALC:MON:TRAC3:FAIL? returns a zero if there is no failure, 1 if the trace exceeds either the limit or the margin.
Initial S/W Revision	A.13.00

### Limit Line Control (Remote Command Only)

Defines a list of limit line control (frequency or time) values for a given limit line. Up to 2000 points may be defined for each limit using the following parameters.

<x> Frequency or time values as specified by :Calculate:LLINe:CONTRol:DOMain. Units default to Hz (for frequency) and seconds (for time).

Range: -30 Gs to +30 Gs for time limits, -3 kHz to +1200 GHz for frequency limits.

<b>Remote Command</b>	:CALCulate:LLINe[1] 2 ... 6:CONTRol[:DATA] <x>, <x>, ... :CALCulate:LLINe[1] 2 ... 6:CONTRol[:DATA]?
<b>Example</b>	CALC:LLIN:CONT 1GHz, 2GHz, 2GHz, 3GHz Describes the X values of a stair-stepped limit line. CALC:LLIN:CONT?
Preset	Unaffected by Preset
State Saved	Saved in instrument state
<b>Backwards Compatibility SCPI</b>	:CALCulate[1] 2:LIMit[1] 2 ... 6:CONTRol[:DATA]
Backwards Compatibility SCPI Notes	This command above is included for ESU compatibility. The suffix 1 2 is irrelevant to the measurement, they are added solely for remote language compatibility.
Initial S/W Revision	A.13.00

<b>Remote Command</b>	:CALCulate:LLINe[1] 2 ... 6:CONTRol:POINTs?
-----------------------	---

<b>Example</b>	CALC:LLIN:CONT:POIN? Returns the number of points in the limit line.
Preset	1
State Saved	Saved in instrument state
Initial S/W Revision	A.13.00

### Limit Line Upper (Remote Command Only, SCPI standard compatibility)

Defines a list of amplitude values for a given limit line. Changing the number of elements in the list spectrum will automatically turn the limit line off. Using the “UPP” syntax defines an upper limit line. There is no lower limit line in Monitor Spectrum measurement. Up to 200 points may be defined for each limit using the following parameters.

<ampl>Amplitude values units default to dBm.

Range: -200 dBm to +100 dBm

The points query returns the number of points in the amplitude list. It will not be possible to turn on the limit line unless the number of points in the control matches the number of points in the amplitude.

The points query returns the number of points in the amplitude list. It should match the number of points in the control, that is, the number of values for the CONTROL axis and for the corresponding limit lines must be identical. If one array is larger than the other, the limit trace is built using only as much data as is contained in the smaller array.

An empty array returns the system error “list is empty” to a data query, 0 to a POINTs query.

<b>Remote Command</b>	:CALCulate:LLINE[1] 2 ... 6:UPPer[:DATA] <ampl>, <ampl>, ... :CALCulate:LLINE[1] 2 ... 6:UPPer[:DATA]?
<b>Example</b>	:CALC:LLIN:UPP -10, -10, -20, -20 describes the amplitude values of an upper limit line
Preset	Limit line data is cleared by Restore Mode Defaults.
State Saved	Saved in instrument state.
<b>Backwards Compatibility SCPI</b>	:CALCulate:LIMit[1] 2 ... 6:UPPer[:DATA]
Initial S/W Revision	A.13.00

<b>Remote Command</b>	:CALCulate:LLINE[1] 2 ... 6:UPPer:POINTs?
<b>Example</b>	:CALC:LLIN:UPP:POIN? returns the number of points in the upper limit line.
Preset	Upper Limit line data/points is cleared by Restore Mode Defaults.
State Saved	Saved in instrument state.
Initial S/W Revision	A.13.00

## Analog Demod Tune & Listen

The Analog Demod Tune & Listen key opens the Analog Demod menu that contains keys to turn the demod function on and off and select the modulation type.

Key Path	Meas Setup
<b>Remote Command</b>	<code>[ :SENSe ] :MONitor:DEMod AM FM OFF</code> <code>[ :SENSe ] :MONitor:DEMod?</code>
<b>Example</b>	MON:DEM AM Turns ON amplitude demodulation function. MON:DEM?
Preset	OFF
State Saved	Saved in instrument state
Range	AM FM Off
Readback Text	AM FM Off
<b>Backwards Compatibility SCPI</b>	<code>:SENSe1  SENSe2:DEMod OFF AM FM</code> <code>[ :SENSe ] :DEMod?</code>
Backwards Compatibility SCPI Notes	This command above is included for ESU compatibility. The suffix 1 2 is irrelevant to the measurement, they are added solely for remote language compatibility. This SCPI is Meas Local and Context Sensitive.
Initial S/W Revision	A.13.00

## AM

Pressing this key, when it is not selected, selects and activates the AM demodulation function.

Key Path	Meas Setup, Analog Demod Tune&Listen
<b>Example</b>	MON:DEM AM Turns AM demodulation function ON.
State Saved	Saved in instrument state
Initial S/W Revision	A.13.00

## FM

Pressing this key, when it is not selected, selects and activates the FM demodulation function. Pressing it a second time branches to the FM Demod menu where FM demodulation settings can be adjusted.

Key Path	Meas Setup, Analog Demod Tune&Listen
<b>Example</b>	MON:DEM FM Turns FM demodulation function ON.
State Saved	Saved in instrument state
Initial S/W Revision	A.13.00

### De-emphasis (FM Demod Only)

The De-emphasis setting controls a single-pole filter (6 dB/octave roll off), usually to counter intentional pre-emphasis in the transmitter. When De-emphasis state is OFF the hardware digital filter is bypassed, otherwise the setting is applied.

Key Path	Meas Setup, Analog Demod, FM
Remote Command	[ :SENSe ] :MONitor :DEMod :FM :DEEMphasis OFF   US25   US50   US75   US750 [ :SENSe ] :MONitor :DEMod :FM :DEEMphasis?
Example	MON:DEM:FM:DEEM US75 MON:DEM:FM:DEEM?
Notes	Only available in FM. Grayed out for AM and PM.
Preset	US75
State Saved	Saved in instrument state
Range	OFF US25 US50 US75 US750
Initial S/W Revision	A.13.00

#### Off

This setting bypasses the De-emphasis filter.

Key Path	Meas Setup, Analog Demod Tune&Listen, FM, De-emphasis
Example	MON:DEM:FM:DEEM OFF
Readback	Off
Initial S/W Revision	A.13.00

#### 25 $\mu$ s

Sets the De-emphasis time constant to 25 $\mu$ s.

Key Path	Meas Setup, Analog Demod Tune&Listen, FM, De-emphasis
Example	MON:DEM:FM:DEEM US25
Readback	25 $\infty$ s
Initial S/W Revision	A.13.00

#### 50 $\mu$ s

Sets the De-emphasis time constant to 50  $\mu$ s.

Key Path	Meas Setup, Analog Demod Tune&Listen, FM, De-emphasis
Example	MON:DEM:FM:DEEM US50

Readback	50 ∞s
Initial S/W Revision	A.13.00

75 μs

Sets the De-emphasis time constant to 75 μs.

Key Path	Meas Setup, Analog Demod Tune&Listen, FM, De-emphasis
<b>Example</b>	MON:DEM:FM:DEEM US75
Readback	75 ∞s
Initial S/W Revision	A.13.00

750 μs

Sets the De-emphasis time constant to 750 μsec.

Key Path	Meas Setup, Analog Demod Tune&Listen, FM, De-emphasis
<b>Example</b>	MON:DEM:FM:DEEM US750
Readback	750 ∞s
Initial S/W Revision	A.13.00

**Off**

Pressing this key, turns the demodulation function off.

Key Path	Meas Setup, Analog Demod
<b>Example</b>	:MON:DEM OFF Turns off demodulation function.
State Saved	Saved in instrument state
Initial S/W Revision	A.13.00

**Meas Preset**

This key returns the Meas Local variables in the Monitor Spectrum measurement to their preset values. This is the same as sending the SCPI command CONF:MON

Key Path	Meas Setup
Initial S/W Revision	A.13.00

10 Monitor Spectrum Measurement  
Mode

Mode

See "[Mode](#)" on page 222



## Mode Preset

Returns the active mode to a known state.

Mode Preset does the following for the currently active mode:

- Aborts the currently running measurement.
- Brings up the default menu for the mode, with no active function.
- Sets measurement Global settings to their preset values for the active mode only.
- Activates the default measurement.
- Brings up the default menu for the mode.
- Clears the input and output buffers.
- Sets Status Byte to 0.

Mode Preset does not:

- Cause a mode switch
- Affect mode persistent settings
- Affect system settings

See "[How-To Preset](#)" on page 810 for more information.

Key Path	Front-panel key
<b>Remote Command</b>	:SYSTem:PRESet
<b>Example</b>	:SYST:PRES
Notes	*RST is preferred over :SYST:PRES for remote operation. *RST does a Mode Preset, as done by the :SYST:PRES command, and it sets the measurement mode to Single measurement rather than Continuous for optimal remote control throughput. Clears all pending OPC bits. The Status Byte is set to 0.
Couplings	A Mode Preset aborts the currently running measurement, activates the default measurement, and gets the mode to a consistent state with all of the default couplings set.
Backwards Compatibility Notes	In the X-Series, the legacy "Factory Preset" has been replaced with Mode Preset, which only presets the currently active mode, not the entire instrument. In the X-Series, the way to preset the entire instrument is by using System, Restore System Defaults All, which behaves essentially the same way as restore System Defaults does on ESA and PSA. There is also no "Preset Type" as there is on the PSA. There is a green Mode Preset front-panel key that does a Mode Preset and a white-with-green-letters User Preset front-panel key that does a User Preset. The old PRESet:TYPE command is ignored (without generating an error), and SYST:PRES without a parameter does a Mode Preset, which should cover most backward code compatibility issues. The settings and correction data under the Input/Output front-panel key (examples: Input Z Corr, Ext Amp Gain, etc.) are no longer part of any Mode, so they will not be preset by a Mode Preset. They are preset using Restore Input/Output Defaults, Restore System Defaults All. Note that because User Preset does a Recall State, and all of these settings are saved in State, they ARE recalled when using

	User Preset.
Initial S/W Revision	Prior to A.02.00

## How-To Preset

The table below shows all possible presets, their corresponding SCPI commands and front-panel access (key paths). Instrument settings depend on the current measurement context. Some settings are local to the current measurement, some are global (common) across all the measurements in the current mode, and some are global to all the available modes. In a similar way, restoring the settings to their preset state can be done within the different contexts.

Auto Couple - is a measurement local key. It sets all Auto/Man parameter couplings in the measurement to Auto. Any Auto/Man selection that is local to other measurements in the mode will not be affected.

Meas Preset - is a measurement local key. Meas Preset resets all the variables local to the current measurement except the persistent ones.

Mode Preset - resets all the current mode's measurement local and measurement global variables except the persistent ones.

Restore Mode Defaults - resets ALL the Mode variables (and all the Meas global and Meas local variables), including the persistent ones.

Type Of Preset	SCPI Command	Front Panel Access
Auto Couple	:COUPle ALL	Auto Couple front-panel key
Meas Preset	:CONFigure:<Measurement>	Meas Setup Menu
Mode Preset	:SYSTem:PRESet	Mode Preset (green key)
Restore Mode Defaults	:INSTrument:DEFault	Mode Setup Menu
Restore All Mode Defaults	:SYSTem:DEFault MODes	System Menu; Restore System Default Menu
*RST	*RST	not possible (Mode Preset with Single)
Restore Input/Output Defaults	:SYSTem:DEFault INPUt	System Menu; Restore System Default Menu
Restore Power On Defaults	:SYSTem:DEFault PON	System Menu; Restore System Default Menu
Restore Alignment Defaults	:SYSTem:DEFault ALIGN	System Menu; Restore System Default Menu
Restore Miscellaneous Defaults	:SYSTem:DEFault MISC	System Menu; Restore System Default Menu
Restore All System Defaults	:SYSTem:DEFault [ALL] :SYSTem:PRESet:PERsistent	System Menu; Restore System Default Menu
User Preset	:SYSTem:PRESet:USER	User Preset Menu
User Preset All Modes	:SYSTem:PRESet:USER:ALL	User Preset Menu

Power On Mode Preset	:SYSTem:PON:TYPE MODE	System Menu
Power On User Preset	:SYSTem:PON:TYPE USER	System Menu
Power On Last State	:SYSTem:PON:TYPE LAST	System Menu

## Mode Setup

See "[Mode Setup](#)" on page 246

## Peak Search

Accesses a menu of Peak Search functions and performs a peak search. If no peak is found, an error is generated and this function cannot be performed.

Key Path	Front-panel key
Remote Command	:CALCulate:MONitor:MARKer [1]   2   . . .   12:MAXimum
Example	CALC:MON:MARK2:MAX Performs a peak search using marker 2. CALC:MON:MARK2:Y? Queries the marker amplitude (Y-axis) value for marker 2. CALC:MON:MARK2:X? Queries the marker frequency or time (X-axis) value for marker 2. SYST:ERR? Queries the errors to determine if a peak is found. The error -200 will be returned after an unsuccessful search.
Notes	Sending this command selects the subopcoded marker.
Initial S/W Revision	A.13.00

### Next Peak

Moves the selected marker to the peak that has the next highest amplitude that is less than the marker's current value. Only peaks that meet all enabled peak criteria are considered (See ["Peak Criteria" on page 814](#)). If there is no valid peak lower than the current marker position, an error is generated and the marker is not moved.

If the selected marker was off, then it is turned on as a normal marker and a peak search is performed.

Key Path	Peak Search
Remote Command	:CALCulate:MONitor:MARKer [1]   2   . . .   12:MAXimum:NEXT
Example	CALC:MON:MARK2:MAX:NEXT Selects marker 2 and moves it to the peak that is closest in amplitude to the current peak, but the next lower value.
Notes	Sending this command selects the subopcoded marker
Initial S/W Revision	A.13.00

### Next Peak Right

Moves the selected marker to the nearest peak to the right of the current marker that meets all enabled peak criteria. If there is no valid peak to the right of the current marker position, an error is generated and the marker is not moved.

If the selected marker was off, then it is turned on as a normal marker and a peak search is performed.

Key Path	Peak Search
Remote Command	:CALCulate:MONitor:MARKer [1]   2   . . .   12:MAXimum:RIGHT
Example	CALC:MON:MARK2:MAX:RIGH
Initial S/W Revision	A.13.00

### Next Peak Left

Moves the selected marker to the nearest peak to the left of the current marker that meets all enabled peak criteria. If there is no valid peak to the left of the current marker position, an error is generated and the marker is not moved.

If the selected marker was off, then it is turned on as a normal marker and a peak search is performed.

Key Path	Peak Search
<b>Remote Command</b>	:CALCulate:MONitor:MARKer[1] 2 ... 12:MAXimum:LEFT
<b>Example</b>	CALC:MON:MARK2:MAX:LEFT
Initial S/W Revision	A.13.00

### Min Search

Moves the selected marker to the minimum y-axis value on the current trace. Minimum (negative) peak searches do not have to meet the peak search criteria. It just looks for the lowest y-axis value. If the selected marker is Off, it is turned on before the minimum search is performed.

Key Path	Peak Search
<b>Remote Command</b>	:CALCulate:MONitor:MARKer[1] 2 ... 12:MINimum
<b>Example</b>	CALC:MON:MARK:MIN selects marker 1 and moves it to the minimum amplitude value.
Notes	Sending this command selects the subopcoded marker
Initial S/W Revision	A.13.00

### Peak Criteria

Pressing this key opens the Peak Criteria menu and allows you to adjust the Pk Threshold and Pk Excursion parameters used for peak search functions.

For a signal to be identified as a peak it must meet certain criteria. Signals in the negative frequency range and signals very close to 0 Hz are ignored. If either the peak excursion or peak threshold functions are on, then the signal must satisfy those criteria before being identified as a peak.

When peak excursion and peak threshold are both off:

- Peak Search, Continuous Peak Search, and maximum part of Pk-Pk Search will search the trace for the point with the highest y-axis value that does not violate the LO feedthrough rules. A rising and falling slope are not required for these three peak search functions.
- The remaining search functions Next Peak, Next Pk Right, etc. will only consider trace points that have a rising and falling slope on the left and right respectively.

Key Path	Peak Search
State Saved	Saved in instrument state
Initial S/W Revision	A.13.00

## Peak Search Criteria

This menu lets you decide the mode of Peak Search. When Highest Peak is selected, pressing Peak Search finds the highest peak on the marker's trace. If Same as "Next Peak" Criteria is selected, then the search is also forced to consider the Excursion and Threshold found under the "Next Peak" Criteria menu.

Key Path	Peak Search, Peak Criteria
Remote Command	:CALCulate:MONitor:MARKer:PEAK:SEARch:MODE MAXimum   PARAmeter :CALCulate:MONitor:MARKer:PEAK:SEARch:MODE?
Example	CALC:MON:MARK:PEAK:SEAR:MODE MAX
Notes	MAXimum corresponds to the Highest Peak setting PARAmeter corresponds to the Same as "Next Peak" Criteria setting
Preset	MAXimum
State Saved	Saved in instrument state
Range	Highest Peak  Same as "Next Peak" Criteria (Exc & Threshold)
Readback Text	Current state
Initial S/W Revision	A.13.00

## Highest Peak

When this key is selected, pressing the Peak Search key or issuing the equivalent remote command finds the maximum point on the trace, subject to the peak-search qualifications.

Key Path	Peak Search, Peak Criteria, "Peak Search" Criteria
Example	CALC:MON:MARK:PEAK:SEAR:MODE MAX
Readback Text	Highest Peak
Initial S/W Revision	A.13.00

## Same as "Next Peak" Criteria

When this key is selected, pressing the Peak Search key or issuing the equivalent remote command finds the maximum point on the trace, but are subject to the Excursion and Threshold set under the Next Peak Criteria menu. The search is also subject to the peak-search qualifications. This also affects the Continuous Peak Search.

Key Path	Peak Search, Peak Criteria, "Peak Search" Criteria
Example	CALC:MON:MARK:PEAK:SEAR:MODE PAR
Readback Text	Same as Next Pk
Initial S/W Revision	A.13.00

## Next Peak Criteria

This key opens a menu that allows you to independently set the Peak Excursion and Peak Threshold and turn them on and off.

Key Path	Peak Search, Peak Criteria
Initial S/W Revision	A.13.00

## Pk Excursion On/Off

Turns the peak excursion requirement on/off and sets the excursion value. The value defines the minimum amplitude variation (rise and fall) required for a signal to be identified as a peak. For example, if a value of 6 dB is selected, peak search functions like the marker Next Pk Right function and only moves to peaks that rise and fall 6 dB or more.

When both Pk Excursion and Pk Threshold are on, a signal must rise above the Pk Threshold value by at least the Peak Excursion value and then fall back from its local maximum by at least the Peak Excursion value to be considered a peak.

In the event that a sequence of trace points with precisely the same values represents the maximum, the left most point is found.

Key Path	Peak Search, Next Peak Criteria
<b>Remote Command</b>	:CALCulate:MONitor:MARKer:PEAK:EXCursion <rel_ampl> :CALCulate:MONitor:MARKer:PEAK:EXCursion? :CALCulate:MONitor:MARKer:PEAK:EXCursion:STATe ON OFF 1 0 :CALCulate:MONitor:MARKer:PEAK:EXCursion:STATe?
<b>Example</b>	CALC:MON:MARK:PEAK:EXC:STAT ON CALC:MON:MARK:PEAK:EXC 30 DB Sets the minimum peak excursion requirement to 30 dB.
Couplings	Whenever you adjust the value of Pk Excursion (with the knob, step keys, or by completing a numeric entry), and Peak Threshold is turned ON, the Peak Threshold Line and the Peak Excursion Region are displayed. See Section <a href="#">"Pk Threshold Line On/Off" on page 817</a> .
Preset	6.0 dB ON
State Saved	Saved in instrument state
Min	0.0 dB
Max	100.0 dB
Default Unit	dB
Initial S/W Revision	A.13.00



## Pk Threshold On/Off

Turns the peak threshold requirement on/off and sets the threshold value. The peak threshold value defines the minimum signal level (or min threshold) that the peak identification algorithm uses to recognize a peak.

When both Pk Excursion and Pk Threshold are on, a signal must rise above the Pk Threshold value by at least the Peak Excursion value and then fall back from its local maximum by at least the Peak Excursion value to be considered a peak.

Key Path	Peak Search, Next Peak Criteria
Remote Command	:CALCulate:MONitor:MARKer:PEAK:THReshold <real> :CALCulate:MONitor:MARKer:PEAK:THReshold? :CALCulate:MONitor:MARKer:PEAK:THReshold:STATE ON OFF 1 0 :CALCulate:MONitor:MARKer:PEAK:THReshold:STATE?
Example	CALC:MON:MARK:PEAK:THR 46.99 dBuV Sets the threshold to -60 dBm. CALC:MON:MARK:PEAK:THR:STAT OFF Turns off the threshold criterion.
Couplings	When Ref Level Offset changes, Peak Threshold must change by the same amount. Whenever you adjust the value of Pk Excursion (with the knob, step keys, or by completing a numeric entry), and Peak Threshold is turned ON, the Peak Threshold Line and the Peak Excursion Region are displayed
Preset	16.99 dBuV ON
State Saved	Saved in instrument state
Min	-93.01 dBuV
Max	106.99 dBuV
Default Unit	Depends on the current selected Y axis unit
Initial S/W Revision	A.13.00

## Pk Threshold Line On/Off

Turns the peak threshold line on or off.

Key Path	Peak Search, Next Peak Criteria
Notes	Front panel only.
Couplings	If Peak Threshold is Off and the Peak Threshold line is turned on, it should turn on Peak Threshold.
Preset	OFF
State Saved	Saved in instrument state
Initial S/W Revision	A.13.00

### Mkr->CF

Assigns the selected marker's frequency to the Center Frequency setting. This is the same as the Mkr -> CF key in the Mkr -> menu. The key is duplicated here in the Peak Search Menu to allow you to conveniently perform a peak search and marker to CF without having to access two separate menus.

Key Path	Peak Search or Marker ->
Dependencies	Same as specified under Marker To
Initial S/W Revision	A.13.00

### Marker Delta

Performs the same function as the Delta key in the Marker menu. Basically this sets the control mode for the selected marker to Delta mode and moves the reference marker to the current position of the delta marker. The key is duplicated here in the Peak Search Menu to allow you to conveniently perform a peak search and change the marker's control mode to Delta without having to access two separate menus.

Key Path	Peak Search or Marker
Notes	Whenever the selected marker is in Delta mode and you are in the Peak Search menu, the Marker Delta key should be highlighted and the active function for setting its delta value turned on.
Initial S/W Revision	A.13.00

### Peak Search (Remote Command Only)

Performs a Peak Search with the specified marker.

<b>Remote Command</b>	:CALCulate[1] 2:MARKer[1] 2 ... 4:MAXimum[:PEAK]
<b>Example</b>	:CALC:MARK4:MAX Performs a Peak Search with Marker 4.
Backwards Compatibility Notes	Aliased to :CALCulate:MONitor:MARKer[1]2 3 4:MAXimum
Initial S/W Revision	A.13.00

### Next Peak (Remote Command Only)

Performs a Next Peak with the specified marker.

<b>Remote Command</b>	:CALCulate[1] 2:MARKer[1] 2 ... 4:MAXimum:NEXT
<b>Example</b>	:CALC:MARK4:MAX:NEXT Performs a Peak Search with Marker 4.
Backwards Compatibility Notes	Aliased to :CALCulate:MONitor:MARKer[1]2 3 4:MAXimum:NEXT
Initial S/W Revision	A.13.00

### Next Peak Right (Remote Command Only)

Performs a Next Peak Right with the specified marker.

<b>Remote Command</b>	:CALCulate[1] 2:MARKer[1] 2 ... 4:MAXimum:RIGHT
<b>Example</b>	:CALC:MARK4:MAX:RIGH Performs a Next Peak Right with Marker 4.
Backwards Compatibility Notes	Aliased to :CALCulate:MONitor:MARKer[1]2 3 4:MAXimum:RIGHT
Initial S/W Revision	A.13.00

### Next Peak Left (Remote Command Only)

Performs a Next Peak Left with the specified marker.

<b>Remote Command</b>	:CALCulate[1] 2:MARKer[1] 2 ... 4:MAXimum:LEFT
<b>Example</b>	:CALC:MARK4:MAX:LEFT Performs a Next Peak Left with Marker 4.
Backwards Compatibility Notes	Aliased to :CALCulate:MONitor:MARKer[1]2 3 4:MAXimum:LEFT
Initial S/W Revision	A.13.00

### Delta Peak Search (Remote Command Only)

Performs a Peak Search with the specified delta marker.

<b>Remote Command</b>	:CALCulate[1] 2:DELTamarker[1] 2 ... 4:MAXimum[:PEAK]
<b>Example</b>	:CALC:DELT4:MAX Performs a Peak Search with Marker 4.
Backwards Compatibility Notes	Aliased to :CALCulate:MONitor:MARKer[1]2 3 4:MAXimum, however if the specified marker is not on or is not a delta marker, the analyzer turns it on and makes it a delta marker.
Initial S/W Revision	A.13.00

### Delta Next Peak (Remote Command Only)

Performs a Next Peak with the specified delta marker.

<b>Remote Command</b>	:CALCulate[1] 2:DELTamarker[1] 2 ... 4:MAXimum:NEXT
<b>Example</b>	:CALC:DELT4:MAX:NEXT Performs a Next Peak with Delta Marker 4.
Backwards Compatibility Notes	Aliased to :CALCulate:MONitor:MARKer[1]2 3 4:NEXT, however if the specified marker is not on or is not a delta marker, the analyzer first turns it on and makes it a delta marker.
Initial S/W Revision	A.13.00

### Delta Next Peak Right (Remote Command Only)

Performs a Next Peak with the specified delta marker.

<b>Remote Command</b>	:CALCulate[1]   2:DELTamarker[1]   2   ...   4:MAXimum:RIGHT
<b>Example</b>	:CALC:DELT4:MAX:RIGH Performs a Next Peak Right with Delta Marker 4.
<b>Backwards Compatibility Notes</b>	Aliased to :CALCulate:MONitor:MARKer[1]   2   3   4:RIGHT, however if the specified marker is not on or is not a delta marker, the analyzer first turns it on and makes it a delta marker.
<b>Initial S/W Revision</b>	A.13.00

### Delta Next Peak Left (Remote Command Only)

Performs a Next Peak with the specified delta marker.

<b>Remote Command</b>	:CALCulate[1]   2:DELTamarker[1]   2   ...   4:MAXimum:LEFT
<b>Example</b>	:CALC:DELT4:MAX:LEFT Performs a Next Peak Left with Delta Marker 4.
<b>Backwards Compatibility Notes</b>	Aliased to :CALCulate:MONitor:MARKer[1]   2   3   4:NEXT, however if the specified marker is not on or is not a delta marker, the analyzer first turns it on and makes it a delta marker.
<b>Initial S/W Revision</b>	A.13.00

### Delta Min Peak Search (Remote Command Only)

Performs a Min Peak Search with the specified delta marker.

<b>Remote Command</b>	:CALCulate[1]   2:DELTamarker[1]   2   ...   4:MINimum[:PEAK]
<b>Example</b>	:CALC:DELT4:MIN Performs a Min Search with Marker 4.
<b>Backwards Compatibility Notes</b>	Aliased to :CALCulate:MONitor:MARKer[1]   2   3   4:MINimum, however if the specified marker is not on or is not a delta marker, the analyzer first turns it on and makes it a delta marker.
<b>Initial S/W Revision</b>	A.13.00

Print

See "Print" on page 271

## Quick Save

The Quick Save front-panel key repeats the most recent save that was performed from the Save menu, with the following exceptions:

- Register saves are not remembered as Saves for the purpose of the Quick Save function
- If the current measurement does not support the last non-register save that was performed, an informational message is generated, “File type not supported for this measurement”

Quick Save repeats the last type of qualified save (that is, a save qualified by the above criteria) in the last save directory by creating a unique filename using the Auto File Naming algorithm described below.

If Quick Save is pressed after startup and before any qualified Save has been performed, the Quick Save function performs a Screen Image save using the current settings for Screen Image saves (current theme, current directory), which then becomes the “last save” for the purpose of subsequent Quick Saves.

The Auto File Naming feature automatically generates a file name for use when saving a file. The filename consists of a prefix and suffix separated by a dot, as is standard for the Windows® file system. A default prefix exists for each of the available file types:

Type	Default Prefix	Menu
State	State_	(Save/Recall)
Trace + State	State_	(Save/Recall)
Screen	Screen_	(Save/Recall)
Amplitude Corrections	Ampcor_	(Import/Export)
Traces	Trace_	(Import/Export)
Limit Lines	LLine_	(Import/Export)
Measurement Result	MeasR_	(Import/Export)
Capture Buffer	CapBuf_	(Import/Export)

A four digit number is appended to the prefix to create a unique file name. The numbering sequence starts at 0000 within each Mode for each file type and updates incrementally to 9999, then wraps to 0000 again. It remembers where it was through a Mode Preset and when leaving and returning to the Mode. It is reset by Restore Misc Defaults and Restore System Defaults and subsequent running of the instrument application. So, for example, the first auto file name generated for State files is State\_0000.state. The next is State\_0001, and so forth.

One of the key features of Auto File Name is that we guarantee that the Auto File Name will never conflict with an existing file. The algorithm looks for the next available number. If it gets to 9999, then it looks for holes. If it find no holes, that is no more numbers are available, it gives an error.

For example, if when we get to State\_0010.state there is already a State\_0010.state file in the current directory, it advances the counter to State\_0011.state to ensure that no conflict will exist (and then it verifies that State\_0011.state also does not exist in the current directory and advances again if it does, and so forth).

If you enter a file name for a given file type, then the prefix becomes the filename you entered instead of the default prefix, followed by an underscore. The last four letters (the suffix) are the 4-digit number.

For example, if you save a measurement results file as “fred.csv”, then the next auto file name chosen for a measurement results save will be fred\_0000.csv.

**NOTE** Although 0000 is used in the example above, the number that is used is actually the current number in the Meas Results sequence, that is, the number that would have been used if you had not entered your own file name.

**NOTE** If the filename you entered ends with \_dddd, where d=any number, making it look just like an auto file name, then the next auto file name picks up where you left off with the suffix being dddd + 1.

Key Path	Front-panel key
Notes	No remote command for this key specifically.
Initial S/W Revision	Prior to A.02.00

## Recall

The recall key accesses the menu that allows you to load a measurement state and data from external files or registers.

Key Path	Front-panel key
Initial S/W Revision	A.07.00

### State

The Recall State menu lets you choose a register or file from which to recall the state.

The content of a state file includes all of the settings and data required to return the analyzer as closely as possible to the Mode it was in, with the exact settings that were in place, when the save occurred. The Mode settings in each state file include the settings that are affected by Mode Preset, as well as the additional settings affected by Restore Mode Defaults; all of the Mode's settings. In addition, all of the settings of the Input/Output system are included, even though they are outside of the Mode's state, because they are needed to restore the complete setup. Persistent System settings (for example, GPIB address) are not affected by either a Mode Preset or Restore Mode Defaults, nor are they included in a saved State file.

Since each state file is only for one Mode, the settings for other Modes are unaffected when it is loaded. Recall State will cause a mode switch if the state being recalled is not from the current active mode.

After the recall completes, the message "File <filename> recalled" or "Recalled State Register <register number>" is displayed.

For rapid recalls, the State menu lists 16 registers that you can choose from to recall. Pressing a Register key initiates the recall. You can also select a file from which to recall.

The default path for all State Files is:

My Documents\<<mode name>\state

where <mode name> is the parameter used to select the mode with the INST:SEL command (for example, SA for the Spectrum Analyzer).

See "[More Information](#)" on page 825.

Key Path	Recall
Mode	All
<b>Remote Command</b>	:MMEMory:LOAD:STATe <filename>
<b>Example</b>	:MMEM:LOAD:STAT "myState.state" This recalls the file myState.state on the default path
<b>Example</b>	MMEM:LOAD:STAT "MyStateFile.state" This loads the state file data (on the default file directory path) into the instrument state.
Notes	When you pick a file to recall, the analyzer first verifies that the file is recallable in the current instrument by checking the software version and model number of the instrument. If everything



matches, a full recall proceeds by aborting the currently running measurement, clearing any pending operations, and then loading the State from the saved state file. You can open state files from any mode, so recalling a State file switches to the mode that was active when the save occurred. After switching to the mode of the saved state file, mode settings and data (if any for the mode) are loaded with values from the saved file. The saved measurement of the mode becomes the newly active measurement and the data relevant to the measurement (if there is any) is recalled.

If there is a mismatch between file version or model number or instrument version or model number, the recall function tries to recall as much as possible and returns a warning message. It may limit settings that differ based on model number, licensing or version number.

After recalling the state, the Recall State function does the following:

- Makes the saved measurement for the mode the active measurement.
- Clears the input and output buffers.
- Status Byte is set to 0.
- Executes a \*CLS

If the file specified is empty an error is generated. If the specified file does not exist, another error is generated. If there is a mismatch between the file and the proper file type, an error is generated. If there is a mismatch between file version or model number or instrument version or model number, a warning is displayed. Then it returns to the State menu and File Open dialog goes away.

After the Recall, the analyzer exits the Recall menu and returns to the previous menu.

<b>Backwards Compatibility SCPI</b>	:MMEMory:LOAD:STATe 1,<filename>
Initial S/W Revision	Prior to A.02.00

## More Information

In measurements that support saving Traces, for example, Swept SA, the Trace data is saved along with the State in the State file. When recalling the State, the Trace data is recalled as well. Traces are recalled exactly as they were stored, including the writing mode and update and display modes. If a Trace was updating and visible when the State was saved, it will come back updating and visible, and its data will be rewritten right away. When you use State to save and recall traces, any trace whose data must be preserved should be placed in View or Blank mode before saving.

The following table describes the Trace Save and Recall possibilities:

You want to recall state and one trace's data, leaving other traces unaffected.	Save Trace+State from 1 trace. Make sure that no other traces are updating (they should all be in View or Blank mode) when the save is performed.	On Recall, specify the trace you want to load the one trace's data into. This trace will load in View. All other traces' data will be unaffected, although their trace mode will be as it was when the state save was performed.
You want to recall all traces	Save Trace+State from ALL traces.	On Recall, all traces will come back in View (or Blank if they were in Blank or Background when saved)

You want all traces to load exactly as they were when saved.

Save State

On recall, all traces' mode and data will be exactly as they were when saved. Any traces that were updating will have their data immediately overwritten.

### From File...

When you press “From File”, the analyzer brings up a Windows dialog and a menu entitled “File Open.” This menu allows you to navigate to the various fields in the Windows dialog without using a keyboard or mouse. The Tab and Arrow keys can also be used for dialog navigation.

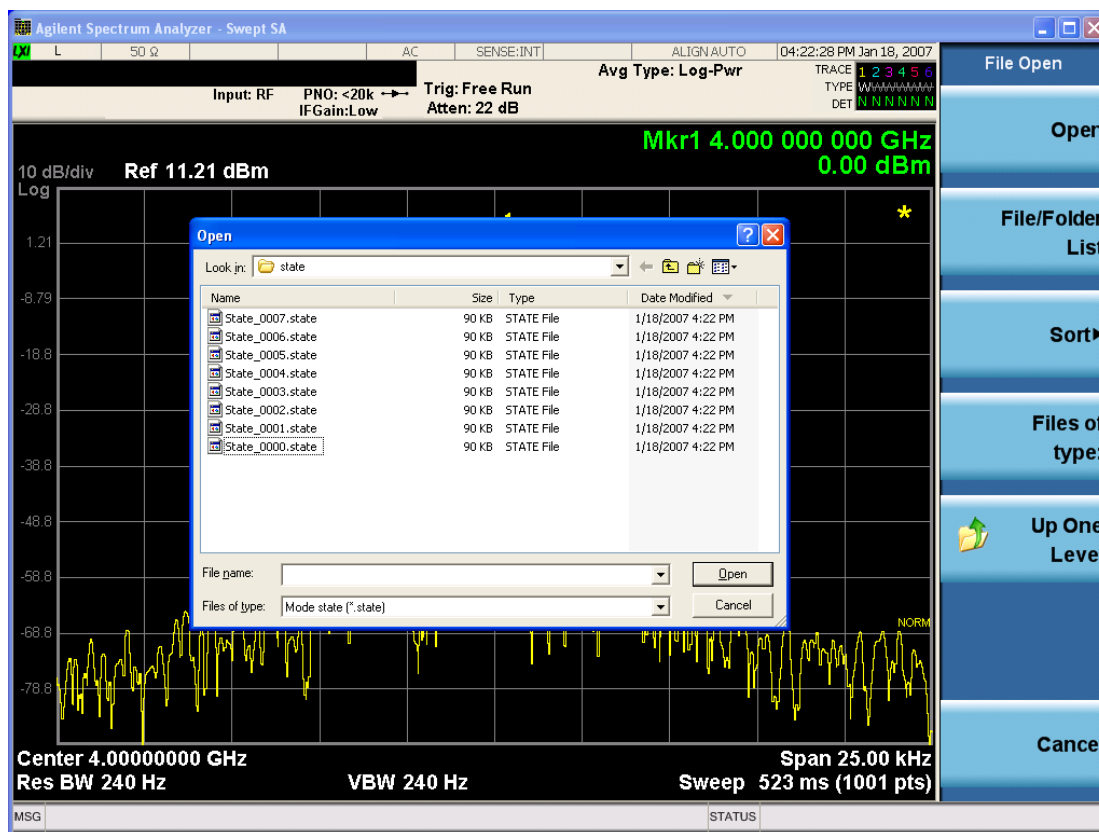

Listed below are the functions of the various fields in the dialog, and the corresponding softkeys:

#### Open

Performs the recall of the specified file. While the recall is being performed, the floppy icon appears briefly in the Meas bar.

#### File/Folder List

Enables you to navigate to the center of the dialog that contains the list of files and folders. Once here you can get information about the file and use the tab keys to navigate to the other fields in the dialog, such as Look In.

## Look In

The Look In field shows the path from which the file will be recalled and allows you to change the path using the up and down arrow keys to navigate to other paths; the Enter key to open a directory; and the Backspace key to go back one directory. The **Look In field** first uses the last path from the Save As dialog **Save In**: path for that same file type. There is no softkey for directly navigating to the Look In field, but you can use the left tab to get here from the File/Folder List.

User specified paths are remembered when you leave and return to a Mode and are reset back to the default using Restore Mode Defaults.

## Sort

Accesses a menu that enables you to sort the files within the File Open dialog. Only one sorting type can be selected at a time and the sorting happens immediately. The sorting types are By Date, By Name, By extension, and By Size.

## Files of Type

This field shows the file suffix for the type of file you have selected to recall. For example, if you navigated here while recalling State, "Mode state (\*.state)" is in the field. If you navigated here while recalling Trace, ""Mode state (\*.trace)" is in the field. If you navigated here while importing a trace data file, "Trace Data (\*.csv)" is in the field. For some file types, there is more than one choice in the dropdown menu, which you can select by using the up and down arrow keys and Enter.

## Up One Level

This key corresponds to the icon of a folder with the up arrow that is in the tool bar of the dialog. When pressed, it causes the file and folder list to navigate up one level in the directory structure. The Backspace key does the same thing.

## Cancel

This key corresponds to the Cancel selection in the dialog. It causes the current **Open** request to be cancelled. The ESC key does the same thing.

Key Path	Recall, State
Notes	Brings up the Open dialog for recalling a State Save Type
Initial S/W Revision	Prior to A.02.00

## Edit Register Names

You may enter a custom name on any of the Register keys, to help you remember what you are using that state to save. To do this, press the Edit Register Names key, choose the register whose name you wish to edit, and then enter the desired label using the Alpha Editor or an external PC keyboard.

The maximum number of characters that can be added is 30. In most cases, 30 characters will fit on two lines of the key.

For more information and the SCPI command, see Edit Register Names under the Save, State function.

Key Path	Recall, State
Mode	All
Dependencies	N9060A-7FP or N9060B-2FP license required to edit the register names. When the feature is not licensed, sending the SCPI command generates an error, -221, "Settings conflict;Option not available"
Initial S/W Revision	A.11.00

### Register 1 thru Register 16

Selecting any one of these register keys causes the State of the mode from the specified Register to be recalled. Each of the register keys annotates whether it is empty or at what date and time it was last modified. In addition, you can use the Edit Register Names key under Save, State to enter custom names for each register.

Registers are shared by all modes, so recalling from any one of the registers will cause a mode switch to the mode that was active when the save to the Register occurred.

Although these 16 registers are the only registers available from the front panel, there are 128 state registers available in the instrument. Registers 17-128 are only available from the SCPI interface, using the \*RCL command.

After the recall completes, the message "Register <register number> recalled" appears in the message bar. If you are in the Spectrum Analyzer Mode, and you are recalling a register that was saved in the Spectrum Analyzer Mode, then after the recall, you will still be in the Recall Register menu. If the Recall causes you to switch modes, then after the Recall, you will be in the Frequency menu.

If a requested register is empty an error is generated.

Key Path	Recall, State
<b>Example</b>	*RCL 1
Range	1-16 from front panel, 1-128 from SCPI
Readback	Date and time with seconds resolution are displayed on the key OR A custom name of up to 30 characters entered using the Save, State, Edit Register Names key OR “(empty)” if no prior save operation has been performed to this register.
Initial S/W Revision	Prior to A.02.00
Modified at S/W Revision	Prior to A.11.00

### Register 1 thru Register 16

Selecting any one of these register keys causes the State of the mode from the specified Register to be recalled. Each of the register keys annotates whether it is empty or at what date and time it was last

modified. In addition, you can use the Edit Register Names key under Save, State to enter custom names for each register.

Registers are shared by all modes, so recalling from any one of the registers will cause a mode switch to the mode that was active when the save to the Register occurred.

Although these 16 registers are the only registers available from the front panel, there are 128 state registers available in the instrument. Registers 17–128 are only available from the SCPI interface, using the \*RCL command.

After the recall completes, the message "Register <register number> recalled" appears in the message bar. If you are in the Spectrum Analyzer Mode, and you are recalling a register that was saved in the Spectrum Analyzer Mode, then after the recall, you will still be in the Recall Register menu. If the Recall causes you to switch modes, then after the Recall, you will be in the Frequency menu.

If a requested register is empty an error is generated.

Key Path	Recall, State
<b>Example</b>	*RCL 1
Range	1–16 from front panel, 1–128 from SCPI
Readback	Date and time with seconds resolution are displayed on the key OR A custom name of up to 30 characters entered using the Save, State, Edit Register Names key OR “(empty)” if no prior save operation has been performed to this register.
Initial S/W Revision	Prior to A.02.00
Modified at S/W Revision	Prior to A.11.00

## Data (Import)

Importing a data file loads data that was previously saved from the current measurement or from other measurements and/or modes that produce compatible data files. The Import Menu only contains Data Types that are supported by the current measurement.

Since the commonly exported data files are in .csv format, the data can be edited by the user prior to importing. This allows you to export a data file, manipulate the data in Excel (the most common PC Application for manipulating .csv files) and then import it.

Importing Data loads measurement data from the specified file into the specified or default destination, depending on the data type selected. Selecting an Import Data menu key will not actually cause the importing to occur, since the analyzer still needs to know from where to get the data. Pressing the Open key in this menu brings up the Open dialog and Open menu that provides you with the options from where to recall the data. Once a filename has been selected or entered in the Open menu, the recall occurs as soon as the Open button is pressed.

Key Path	Recall
Mode	All

Notes	The menu is built from whatever data types are available for the mode. Some keys will be missing completely, so the key locations in the sub-menu will vary. No SCPI command directly controls the Data Type that this key controls. The Data Type is included in the MMEM:LOAD commands.
Dependencies	If a file type is not used by a certain measurement, it is grayed out for that measurement. The key for a file type will not show at all if there are no measurements in the Mode that support it.
Preset	Is not affected by Preset or shutdown, but is reset during Restore Mode Defaults
Readback	The data type that is currently selected
Initial S/W Revision	Prior to A.02.00

## Amplitude Correction

This key selects the Amplitude Corrections as the data type to be imported. When pressed a second time, it brings up the Select Menu, which lets you select the Correction into which the data will be imported.

Amplitude Corrections are fully discussed in the documentation of the Input/Output key, under the Corrections key.

A set of preloaded Corrections files can be found in the directory

/My Documents/ EMC Limits and Ampcor.

When the Amplitude Correction is an Antenna correction and the Antenna Unit in the file is not None, the Y Axis Unit setting will change to match the Antenna Unit in the file.

Key Path	Recall
Mode	SA EDGE GSM PN
Remote Command	:MMEMory:LOAD:CORRection 1 2 3 4 5 6 7 8, <filename>
Example	:MMEM:LOAD:CORR 2, "myAmpcor.csv" recalls the Amplitude Correction data from the file myAmpcor.csv in the current directory to the 2nd Amplitude Correction table, and turns on Correction 2. The default path is D:\User_My_Documents\Instrument\My Documents\amplitudeCorrections\
Dependencies	Only the first correction array (Correction 1) supports antenna units. This means that a correction file with an Antenna Unit can only be loaded into the Corrections 1 register. Consequently only for Correction 1 does the dropdown in the Recall dialog include.ant, and if an attempt is made to load a correction file into any other Correction register which DOES contain an antenna unit, a Mass Storage error is generated. Corrections are not supported by all Measurements. If in a Mode in which some Measurements support it, this key will be grayed out in measurements that do not. The key will not show at all if no measurements in the Mode support it. Errors are reported if the file is empty or missing, or if the file type does not match, or if there is a mismatch between the file type and the destination data type. If any of these occur during manual operation, the analyzer returns to the Import Data menu and the File Open dialog goes away. This key does not appear unless you have the proper option installed in your instrument. This command will generate an "Option not available" error unless you have the proper option installed in your instrument.

Couplings	When a correction file is loaded from mass storage, it is automatically turned on ( <b>Correction ON</b> ) and <b>ApplyCorrections</b> is set to On. This allows you to see its effect, thus confirming the load.
Readback	selected Correction
<b>Backwards Compatibility SCPI</b>	:MMEMory:LOAD:CORRection ANTenna   CABLe   OTher   USER, <filename> For backwards compatibility, ANTenna maps to 1, CABLe maps to 2, OTher maps to 3 and USER maps to 4
Initial S/W Revision	A.02.00

### Amplitude Correction

This key selects the Amplitude Corrections as the data type to be imported. When pressed a second time, it brings up the Select Menu, which lets you select the Correction into which the data will be imported.

Amplitude Corrections are fully discussed in the documentation of the Input/Output key, under the Corrections key.

A set of preloaded Corrections files can be found in the directory

/My Documents/ EMC Limits and Ampcor.

When the Amplitude Correction is an Antenna correction and the Antenna Unit in the file is not None, the Y Axis Unit setting will change to match the Antenna Unit in the file.

Key Path	Recall
Mode	SA EDGE GSM PN
<b>Remote Command</b>	:MMEMory:LOAD:CORRection 1 2 3 4 5 6 7 8, <filename>
<b>Example</b>	:MMEM:LOAD:CORR 2, "myAmpcor.csv" recalls the Amplitude Correction data from the file myAmpcor.csv in the current directory to the 2nd Amplitude Correction table, and turns on Correction 2. The default path is D:\User_My_Documents\Instrument\My Documents\amplitudeCorrections\
Dependencies	Only the first correction array (Correction 1) supports antenna units. This means that a correction file with an Antenna Unit can only be loaded into the Corrections 1 register. Consequently only for Correction 1 does the dropdown in the Recall dialog include.ant, and if an attempt is made to load a correction file into any other Correction register which DOES contain an antenna unit, a Mass Storage error is generated. Corrections are not supported by all Measurements. If in a Mode in which some Measurements support it, this key will be grayed out in measurements that do not. The key will not show at all if no measurements in the Mode support it. Errors are reported if the file is empty or missing, or if the file type does not match, or if there is a mismatch between the file type and the destination data type. If any of these occur during manual operation, the analyzer returns to the Import Data menu and the File Open dialog goes away. This key does not appear unless you have the proper option installed in your instrument. This command will generate an "Option not available" error unless you have the proper option installed in your instrument.

Couplings	When a correction file is loaded from mass storage, it is automatically turned on ( <b>Correction ON</b> ) and <b>ApplyCorrections</b> is set to On. This allows you to see its effect, thus confirming the load.
Readback	selected Correction
<b>Backwards Compatibility SCPI</b>	:MMEMory:LOAD:CORRection ANTenna   CABLe   OTHer   USER, <filename> For backwards compatibility, ANTenna maps to 1, CABLe maps to 2, OTHer maps to 3 and USER maps to 4
Initial S/W Revision	A.02.00

### Amplitude Correction

These keys let you select which Correction to import the data into. Once selected, the key returns back to the Import Data menu and the selected Correction number is annotated on the key. The next step is to select the Open key in the Import Data menu.

Antenna corrections are a particular kind of Amplitude Corrections – they are distinguished in the corrections file by having the Antenna Unit set to a value other than None. Only Correction 1 supports Antenna Units.

Key Path	Recall, Data, Amplitude Correction
Notes	auto return
Dependencies	Only Correction 1 may be used to load a Correction that contains an Antenna Unit other than None
Preset	Not part of Preset, but is reset to Correction 1 by Restore Input/Output Defaults; survives shutdown.
State Saved	The current Correction number is saved in instrument state
Initial S/W Revision	A.02.00

### Default Directory

Specifies the default directory used for loading of Amplitude Correction. If user is selected, the default recall directory is the default (My Documents\amplitudeCorrections) or the last directory you saved the amplitude correction data to. Otherwise, the default recall directory is My Documents\EMC Limits and Ampcor\Ampcor, which contains a set of preloaded amplitude correction files in the directory called Ampcor.

Key Path	Recall, Export Data, Amplitude Correction
<b>Remote Command</b>	:MMEMory:LOAD:CORRection:DDIRectory USER PRELoaded
<b>Example</b>	:MMEM:LOAD:CORR:DDIR USER Select user :MMEM:LOAD:CORR:DDIR?
Notes	USER = User PRELoaded = Preloaded
Preset	PRELoaded



State Saved	Saved in instrument state.
Range	User  Preloaded
Readback	“User”  “Preloaded”
Initial S/W Revision	A.13.00

## Trace

This key selects Trace as the data type to be imported. When pressed a second time, it brings up the Trace Menu, which lets you select the Trace into which the data will be imported.

The trace file contains “meta” data which describes the state of the analyzer when the trace was exported (see Trace File Contents). If the meta data in the file does not match the current SA state, the “invalid data indicator” (\*) is displayed.

Key Path	Recall, Data
<b>Remote Command</b>	:MMEMory:LOAD:TRACe:DATA TRACE1   TRACE2   TRACE3   TRACE4   TRACE5   TRACE6,<filename>
<b>Example</b>	:MMEM:LOAD:TRAC DATA TRACE2, "myTrace2.csv" Imports the 2nd trace from the file myTrace2.csv in the current path. The default path is My Documents\SA\data\traces
Dependencies	For SA measurements, a trace cannot be recalled from a trace file that was exported with ALL traces selected.  A trace cannot be imported if the number of trace points in the file do not match the number of sweep points currently set for the measurement. If this happens, an error message is generated. Errors are reported if the file is empty or missing, or if the file type does not match, or if there is a mismatch between the file type and the destination data type.  If any error occurs while trying to load a file manually (as opposed to during remote operation), the analyzer returns to the Import Data menu and the File Open dialog goes away.
Couplings	When a trace is imported, <b>Trace Update</b> is always turned OFF for that trace and <b>Trace Display</b> is always turned ON.
Readback	Selected Trace
Status Bits/OPC dependencies	Sequential - aborts the current measurement.
Initial S/W Revision	Prior to A.02.00

## Limit

This key selects Limit Lines as the data type to be imported. When pressed a second time, it brings up the Limits Menu, which lets you select into which Limit the data will be imported.

Key Path	Recall, Data
<b>Remote Command</b>	:MMEMory:LOAD:LIMit LLINE1   LLINE2   LLINE3   LLINE4   LLINE5   LLINE6,<filename>
<b>Example</b>	:MMEM:LOAD:LIM LLINE2, "myLimitLine2.csv" imports the 2nd Limit Line from the file

	myLimitLine2.csv in the current path. The default path is depending on the Limit Default Directory selection.
Dependencies	Errors are reported if the file is empty or missing, or if the file type does not match, or if there is a mismatch between the file type and the destination data type. If any of these occur during manual operation, the analyzer returns to the Import Data menu and the File Open dialog goes away. This key will only appear if you have the proper option installed in your instrument.
Couplings	When a limit line is loaded from mass storage, it is automatically turned on. This allows you to see it, thus confirming the load. The Margin settings will match those set when the limit was saved
Readback	1 2 3 4 5 6
Status Bits/OPC dependencies	Sequential - aborts the current measurement
Initial S/W Revision	A.02.00

### Limit Selection

These keys let you pick which Limit Line to import the data into; either 1, 2, 3, 4, 5 or 6. The default is the currently selected limit. Once selected, the key returns back to the Import Data menu and the selected Limit Line number is annotated on the key. Now you have selected exactly what needs to be imported. In order to trigger an import of the selected Limit Line, you must select the Open key in the Import Data menu.

An example of using this menu is: If you select 2 and continue to the File Open menu, Limit Line 2 will be imported from the file selected or entered in File Name option in the File Open dialog.

Key Path	Recall, Data, Limit Line
Notes	Auto return
Preset	Not part of Preset, but is reset to LLINE1 by Restore Mode Defaults; survives a shutdown.
State Saved	The selected limit number is saved in instrument state
Initial S/W Revision	A.02.00

### Default Directory

Specifies the default directory used for loading of Limit. If user is selected, the default recall directory is the default (My Documents\EMI\data\xxx\Limits where xxx is the measurement name) or the last directory you saved the limit line data to. Otherwise, the default recall directory is My Documents\EMC Limits and Ampcor\Limits, which contains a set of preloaded limit files.

Key Path	Recall, Export Data, Limit
<b>Remote Command</b>	:MMEMory:LOAD:LIMit:DDIRectory USER PRELoaded
<b>Example</b>	:MMEM:LOAD:LIM:DDIR USER Select user :MMEM:LOAD:LIM:DDIR?
Notes	USER = User PRELoaded = Preloaded

Preset	PRELoaded
State Saved	Saved in instrument state.
Range	User  Preloaded
Readback	“User”  “Preloaded”
Initial S/W Revision	A.13.00

## Open...

When you press “Open”, the analyzer brings up a Windows dialog and a menu entitled “**File Open.**” This menu allows you to navigate to the various fields in the Windows dialog without using a keyboard or mouse. The Tab and Arrow keys can also be used for dialog navigation.

See "[From File...](#)" on page 1083 in Recall, State, for a full description of this dialog and menu.

Key Path	Recall, Data
Notes	The key location is mode-dependent and will vary. Brings up Open dialog for recalling a <mode specific> Save Type
Initial S/W Revision	Prior to A.02.00

## Restart

The Restart function restarts the current sweep, or measurement, or set of averaged/held sweeps or measurements. If you are Paused, pressing Restart does a Resume.

The Restart function is accessed in several ways:

- Pressing the Restart key
- Sending the remote command INIT:IMMediate
- Sending the remote command INIT:REStart

See "[More Information](#)" on page 836

Key Path	Front-panel key
Remote Command	:INITiate[:IMMediate] :INITiate:REStart
Example	:INIT:IMM :INIT:REST
Notes	:INITiate:REStart and :INITiate:IMMediate perform exactly the same function.
Couplings	Resets average/hold count k. For the first sweep overwrites all active (update=on) traces with new current data. For application modes, it resets other parameters as required by the measurement.
Status Bits/OPC dependencies	This is an Overlapped command. The STATus:OPERation register bits 0 through 8 are cleared. The STATus:QUESTionable register bit 9 (INTegrity sum) is cleared. The SWEEPING bit is set. The MEASURING bit is set.
Backwards Compatibility Notes	For Spectrum Analysis mode in ESA and PSA, the Restart hardkey and the INITiate:REStart command restart trace averages (displayed average count reset to 1) for a trace in Clear Write, but did not restart Max Hold and Min Hold.  In the X-Series, the Restart hardkey and the INITiate:REStart command restart not only Trace Average, but MaxHold and MinHold traces as well.  For wireless comms modes in ESA and PSA, the Restart hardkey and the INITiate:REStart command restart every measurement, which includes all traces and numeric results. There is no change to this operation.
Initial S/W Revision	Prior to A.02.00

### More Information

The **Restart** function first aborts the current sweep/measurement as quickly as possible. It then resets the sweep and trigger systems, sets up the measurement and initiates a new data measurement sequence with a new data acquisition (sweep) taken once the trigger condition is met.

If the analyzer is in the process of aligning when **Restart** is executed, the alignment finishes before the restart function is performed.

Even when set for Single operation, multiple sweeps may be taken when Restart is pressed (for example, when averaging/holding is on). Thus when we say that **Restart** "restarts a measurement," we may mean:

- It restarts the current sweep
- It restarts the current measurement
- It restarts the current set of sweeps if any trace is in Trace Average, Max Hold or Min Hold
- It restarts the current set of measurements if Averaging, or Max Hold, or Min Hold is on for the measurement
- depending on the current settings.

With **Average/Hold Number** (in **Meas Setup** menu) set to 1, or Averaging off, or no trace in Trace Average or Hold, a single sweep is equivalent to a single measurement. A single sweep is taken after the trigger condition is met; and the analyzer stops sweeping once that sweep has completed. However, with **Average/Hold Number** >1 and at least one trace set to **Trace Average, Max Hold, or Min Hold (SA Measurement)** or **Averaging on (most other measurements)**, multiple sweeps/data acquisitions are taken for a single measurement. The trigger condition must be met prior to each sweep. The sweep is stopped when the average count  $k$  equals the number  $N$  set for **Average/Hold Number**. A measurement average usually applies to all traces, marker results, and numeric results; but sometimes it only applies to the numeric results.

Once the full set of sweeps has been taken, the analyzer will go to idle state. To take one more sweep without resetting the average count, increment the average count by 1, by pressing the step up key while **Average/Hold Number** is the active function, or sending the remote command `CALC:AVER:TCON UP`.

## Save

The Save menu lets you choose what you want to save and where you want to save it. Among the types of files you can save are **States**, **Traces**, and **Screen Images**. In addition, an Export (Data) option lets you save a number of data types as CSV files for easy import into Excel and other spreadsheet programs.

Key Path	Front-panel key
Mode	All
Notes	No remote command for this key specifically, but the :MMEM:STORe command is available for specific file types. An example is :MMEM:STOR:STATe <filename>.
Initial S/W Revision	Prior to A.02.00

## State

The Save State menu lets you choose a register or file for saving the state.

The content of a state file includes all of the settings and data required to return the analyzer as closely as possible to the Mode it was in, with the exact settings which were in place, when the save occurred. The Mode settings in each state file include the settings that are affected by Mode Preset, as well as the additional settings affected by Restore Mode Defaults; all of the Mode's settings. In addition, all of the settings of the Input/Output system are included, even though they are outside of the Mode's state, because they are needed to restore the complete setup. Persistent System settings (for example, Verbose SCPI) are not affected by either Mode Preset or Restore Mode Defaults, nor are they included in a saved State file.

After the save completes, the message "File <filename> saved" or "State Register <register number> saved" is displayed.

For rapid saving, the State menu lists 16 registers to save to. Pressing a Register key initiates the save. You can also select a file to save to.

The default path for all State Files is:

My Documents\<<mode name>\state

where <mode name> is the parameter used to select the mode with the INST:SEL command (for example, SA for the Spectrum Analyzer).

Key Path	Save
Mode	All
Remote Command	:MMEMory:STORe:STATe <filename>
Example	MMEM:STOR:STATe "MyStateFile.state" This stores the current instrument state data in the file MyStateFile.state in the default directory.
Notes	Both single and double quotes are supported for any filename parameter over remote. After saving to a register, that register's menu key is updated with the date the time, unless a custom label has been entered for that key. After saving to a register, you remain in the Save State menu, so that you can see the Register key

update. After saving to a file, the analyzer automatically returns to the previous menu and any Save As dialog goes away.

<b>Backwards Compatibility SCPI</b>	:MMEMory:STORe:STATe 1,<filename>
Initial S/W Revision	Prior to A.02.00

### To File . . .

When you press “To File”, the analyzer brings up a Windows dialog and a menu entitled “**Save As.**” This menu allows you to navigate to the various fields in the Windows dialog without using a keyboard or mouse. The Tab and Arrow keys can also be used for dialog navigation.

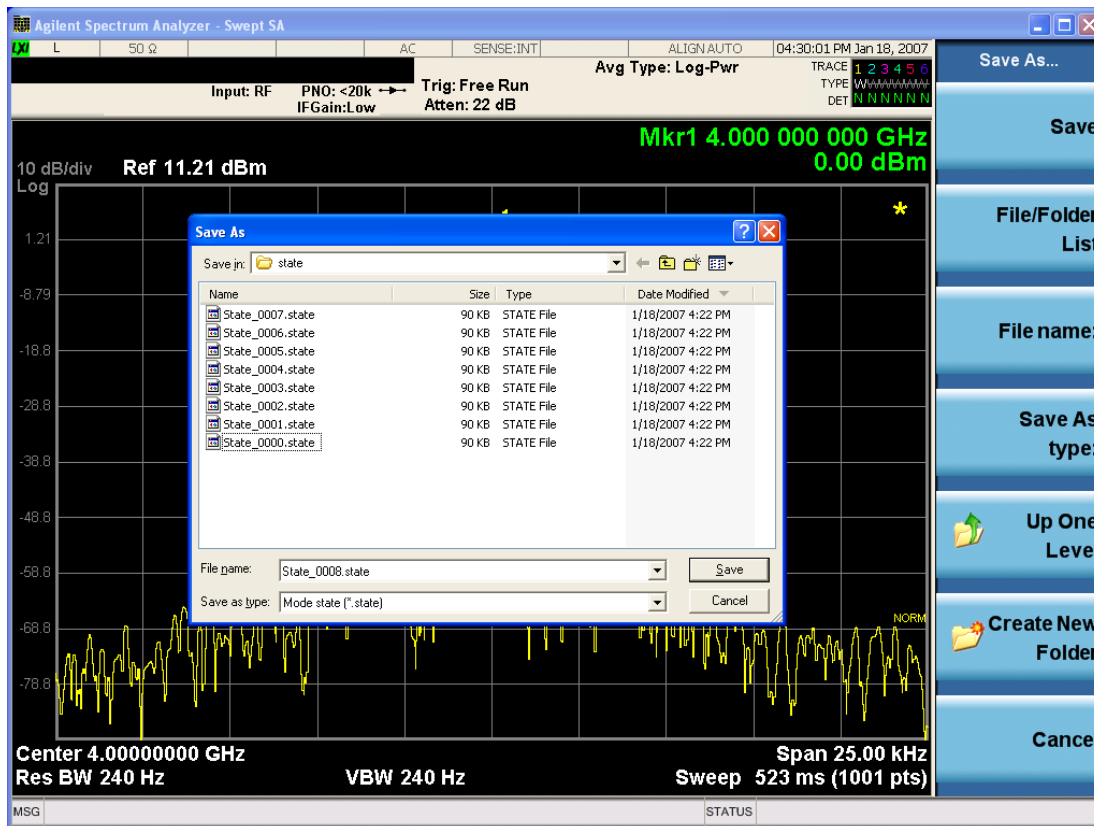

The Listed below

are the functions of the various fields in the dialog, and the corresponding softkeys:

#### Save

Performs the save to the specified file of the selected type. If the file already exists, a dialog will appear that allows you to replace the existing file by selecting OK, or you can Cancel the request. If you select OK, the file will be overwritten. Using the C: drive is strongly discouraged, since it runs the risk of being overwritten during an instrument software upgrade.

While the save is being performed, the floppy icon appears briefly in the Meas bar.

### File/Folder List

Enables you to navigate to the center of the dialog that contains the list of files and folders. Once here you can get information about the file and use the tab keys to navigate to the other fields in the dialog, such as Save In.

### Save In

The Save In field shows the path to which the file will be saved and allows you to change the path using the up and down arrow keys to navigate to other paths; the Enter key to open a directory; and the Backspace key to go back one directory. The **Save In field** defaults to the default path for this type of file and remembers the last path you used to save this type of file. There is no softkey for directly navigating to the Save In field but you can use left tab to get here from the File/Folder List.

User specified paths are remembered when you leave and return to a Mode and are reset back to the default using Restore Mode Defaults.

### File Name

The File Name field is initially loaded with an automatically generated filename specific to the appropriate Save Type. The automatically generated filename is guaranteed not to conflict with any filename currently in the directory. You may replace or modify this filename using the File Name key. See the ["Quick Save " on page 1079](#) documentation for more on the automatic file naming algorithm.

When you press the File Name key the analyzer displays the Alpha Editor. Use the knob to choose the letter to add and the front-panel Enter key to add the letter to the file name. The BK character moves you back and the FW character moves you forward in the filename. The Select key on the front panel generates a space character. When you are done entering the filename press the Done softkey. This returns back to the **File Open** dialog and menu, but does not cause the save to occur.

### Save As Type

This field shows the file suffix for the type of file you have selected to save. For example, if you navigated here while saving State, "Mode state (\*.state)" is in the field. If you navigated here from saving Trace, ""Mode state (\*.trace)" is in the field. If you navigated here while exporting a trace data file, "Trace Data (\*.csv)" is in the field. For some file types, there is more than one choice in the dropdown, which you can select by using the up and down arrow keys and Enter.

### Up One Level

This key corresponds to the icon of a folder with the up arrow that is in the tool bar of the dialog. When pressed, it causes the file and folder list to navigate up one level in the directory structure. The Backspace key does the same thing.

### Create New Folder

This key corresponds to the icon of a folder with the "\*" that is in the tool bar of the dialog. When pressed, a new folder is created in the current directory with the name **New Folder** and you can enter a new folder name using the Alpha Editor.

### Cancel

This key corresponds to the Cancel selection in the dialog. It causes the current **Save As** request to be cancelled. The ESC key does the same thing.



Key Path	Save, State
Mode	All
Notes	Brings up Save As dialog for saving a State Save Type
Initial S/W Revision	Prior to A.02.00

## Edit Register Names

You may enter a custom name on any of the Register keys, to help you remember what you are using that state to save. To do this, press the Edit Register Names key, choose the register whose name you wish to edit, and then enter the desired label using the Alpha Editor or an external PC keyboard.

The maximum number of characters that can be added is 30. In most cases, 30 characters will fit on two lines of the key.

See "[More Information](#)" on page 841

Key Path	Save, State
Mode	All
<b>Remote Command</b>	:MMEMory:REGister:STATe:LABel <reg number>,"label" :MMEMory:REGister:STATe:LABel? <reg number>
<b>Example</b>	:MMEM:REG:STAT:LAB 1,"my label"
Notes	<reg number> is an integer from 1 to 16. If the SCPI specifies an invalid register number an error message is generated, -222,"Data out of range;Invalid register label number" "label" is a string from 0 to 30 characters in length. If a label exceeds 30 characters, an error message is generated, -150,"String data error;Label clipped to 30 characters" "label" of length 0 erases the custom label and restores the default (time and date) label. E.g.: :MMEM:REG:STAT:LAB 1,""
Dependencies	N9060A-7FP or N9060B-2FP license required to edit the register names. When the feature is not licensed, sending this command generates an error, -221,"Settings conflict;Option not available"
Preset	The names are unaffected by Preset or power cycle but are set to the default label (time and date) on a "Restore System Defaults->Misc"
Initial S/W Revision	A.11.00

## More Information

When you edit one of the register names, the time and date field will be replaced by the custom name.

If you delete all the characters in the custom name, it restores the default (time and date).

The register names are stored within the state files, but they are not part of the instrument state; that is, once you have edited a register name, loading a new state will not change that register name. Another consequence of this is that the names will be persistent through a power cycle. Also, if a named state file is transferred to another analyzer, it will bring its custom name along with it.

If you try to edit the name of an empty register, the analyzer will first save the state to have a file to put the name in. If you load a named state file into an analyzer with older firmware it will ignore the metadata.

The \*SAV and \*RCL commands will not be affected by the custom register names, nor will the MMEM commands.

### Register 1 thru Register 16

Selecting any one of these register menu keys causes the State of the currently active mode to be saved to the specified Register. The registers are provided for rapid saving and recalling, since you do not need to specify a filename or navigate to a file. Each of the register menu keys annotates whether it is empty or at what date and time it was last modified. In addition, you can use the Edit Register Names key to enter custom names for each register.

Although these 16 registers are the only registers available from the front panel, there are 128 state registers available in the instrument. Registers 17–128 are only available from the SCPI interface, using the \*SAV command.

There is one set of 128 state registers in the instrument, not one set for each Mode. When a state is saved, the Mode it was saved from is saved with it; then when it is recalled, the instrument switches to that Mode.

After the save completes, the corresponding register menu key annotation is updated with the date and time and the message "Register <register number> saved" is displayed.

Key Path	Save, State
Mode	All
Example	*SAV 1
Range	1–16 from front panel, 1–128 from SCPI
Readback	Date and time with seconds resolution are displayed on the key OR A custom name of up to 30 characters entered using the Edit Register Names key OR “(empty)” if no prior save operation has been performed to this register.
Initial S/W Revision	Prior to A.02.00
Modified at S/W Revision	A.11.00

### Register 1 thru Register 16

Selecting any one of these register menu keys causes the State of the currently active mode to be saved to the specified Register. The registers are provided for rapid saving and recalling, since you do not need to specify a filename or navigate to a file. Each of the register menu keys annotates whether it is empty or at what date and time it was last modified. In addition, you can use the Edit Register Names key to enter custom names for each register.

Although these 16 registers are the only registers available from the front panel, there are 128 state registers available in the instrument. Registers 17–128 are only available from the SCPI interface, using the \*SAV command.

There is one set of 128 state registers in the instrument, not one set for each Mode. When a state is saved, the Mode it was saved from is saved with it; then when it is recalled, the instrument switches to that Mode.

After the save completes, the corresponding register menu key annotation is updated with the date and time and the message "Register <register number> saved" is displayed.

Key Path	Save, State
Mode	All
Example	*SAV 1
Range	1-16 from front panel, 1-128 from SCPI
Readback	Date and time with seconds resolution are displayed on the key OR A custom name of up to 30 characters entered using the Edit Register Names key OR "(empty)" if no prior save operation has been performed to this register.
Initial S/W Revision	Prior to A.02.00
Modified at S/W Revision	A.11.00

## Data (Export)

Exporting a data file stores data from the current measurement to mass storage files. The Export Menu only contains data types that are supported by the current measurement.

Since the commonly exported data files are in .csv format, the data can be edited by you prior to importing. This allows you to export a data file, manipulate the data in Excel (the most common PC Application for manipulating .csv files) and then import it.

Selecting an Export Data menu key will not actually cause the exporting to occur, since the analyzer still needs to know where you wish to save the data. Pressing the Save As key in this menu brings up the Save As dialog and Save As menu that allows you to specify the destination file and directory. Once a filename has been selected or entered in the Open menu, the export will occur as soon as the Save key is pressed.

Key Path	Save
Mode	All
Notes	The menu is built from whatever data types are available for the mode. So the key locations in the sub menu will vary.  No SCPI command directly controls the Data Type that this key controls. The Data Type is included in the MMEM:STORe commands.
Dependencies	If a file type is not used by a certain measurement, that type is grayed out for that measurement. The key for a file type will not show at all if there are no measurements in the Mode that support it.
Preset	Is not affected by a Preset or shutdown, but is reset during Restore Mode Defaults
Readback	The data type that is currently selected
Initial S/W Revision	Prior to A.02.00

## Amplitude Correction

Pressing this key selects **Amplitude Corrections** as the data type to be exported. Pressing this key again brings up the Select Menu, which allows the user to select which **Amplitude Correction** to save.

Amplitude Corrections are fully discussed in the documentation of the Input/Output key, under the Corrections softkey.

See "[Correction Data File](#) " on page 844

Key Path	Save
<b>Remote Command</b>	:MMEMory:STORe:CORRection 1 2 3 4 5 6, <filename>
<b>Example</b>	:MMEM:STOR:CORR 2 "myAmpcor.csv" saves Correction 2 to the file myAmpcor.csv on the current path. The default path is My Documents\amplitudeCorrections.
Notes	If the save is initiated via SCPI, and the file already exists, the file will be overwritten. Using the C: drive is strongly discouraged, since it runs the risk of being overwritten during an instrument software upgrade. Both single and double quotes are supported for any filename parameter over SCPI.
Dependencies	Corrections are not supported by all Measurements. If in a Mode in which some Measurements support it, this key will be grayed out in measurements that do not. The key will not show at all if no measurements in the Mode support it. This key will not appear unless you have the proper option installed in your instrument.
Readback	Selected Correction
<b>Backwards Compatibility SCPI</b>	:MMEMory:STORe:CORRection ANTenna   CABLe   OTHer   USER, <filename> For backwards compatibility, ANTenna maps to 1, CABLe maps to 2, OTHer maps to 3 and USER maps to 4
Initial S/W Revision	A.02.00

## Correction Data File

A Corrections Data File contains a copy of one of the analyzer correction tables. Corrections provide a way to adjust the trace display for predetermined gain curves (such as for cable loss).

Corrections files are text files in .csv (comma separated values) form, to make them importable into Excel or other spreadsheet programs. The format for Corrections files is as follows.

Line #	Type of field	Example	Notes
1	File type, must be "Amplitude Correction"	Amplitude Correction	May not be omitted
2	File Description (in quotes)	"Correction Factors for 11966E"	60 characters max; may be empty but may not be omitted. If exceeds 60 characters, error -233 Too much data reported
3	Comment (in quotes)	"Class B Radiated"	60 characters max; may be empty but

Line #	Type of field	Example	Notes
			may not be omitted. . If exceeds 60 characters, error -233 Too much data reported
4	Instrument Version, Model #	A.02.06,N9020A	May be empty but may not be omitted
5	Option List, File Format Version	K03 LFE EXM ,01	May be empty but may not be omitted
6	Freq Unit to be used for all frequency values in the file	Frequency Unit,MHz	assumed to be Hz if omitted
7	Antenna Unit	Antenna Unit,None	If omitted leaves the Antenna unit unchanged. The amplitude unit in the Antenna Unit field is a conversion factor that is used to adjust the Y Axis Units of the current mode, if the mode supports Antenna Units. For more details on antenna correction data, refer to the Input/Output,Corrections key description. Allowable values: dBuv/m, dBuA/m, dBG, dBpT, None
8	Freq Interpolation	Frequency Interpolation,Linear	if omitted leaves the Freq Interpolation unchanged. Allowable values: Linear, Logarithmic
9	Bias value in mA	Bias,0.00	If omitted leaves the Bias value unchanged (added as of A.08.50)
10	Bias State	Bias State,On	If omitted leaves the Bias State unchanged. Allowable values: On, Off (added as of A.08.50)
11	Overlap, two values, Freq1 and Freq2, separated by commas.	Overlap,33500,40000	Uses Freq Unit from line 6. Thus, in this example Freq1=33.5 GHz, Freq2= 40.0 GHz (see note below). If omitted leaves the overlap unchanged (added as of A.08.50)
12	DATA marker	DATA	Corrections data begins in the next line

Lines 2 through 5 can be empty but must appear in the file. Lines 6 through 11 are optional, the lines can be left out of the file altogether.

The Overlap row and the two Bias rows apply only to external mixing. Both are read-only, they are never written by the analyzer. The only way to insert or modify these rows is to edit the file with a text editor or a spreadsheet editor. These rows are intended for use by mixer manufacturers, as they allow the manufacturer to insert data about how the mixer corrections were generated and how they should be applied. The Bias rows allow you to specify whether to turn Bias on or off when the Correction is turned on and to specify a Bias value (turning off the Correction does not change the Bias, but turning it back on again sets it to the value specified in the file). The Overlap row allows you to specify an overlap region in which

two different corrections may be applied. It is expected that in the corrections data itself, there will be TWO corrections values exactly at Max Freq, otherwise Overlap is ignored. The way the overlap is processed is as follows: if at any given time the current analyzer Start Freq is greater than Freq 1 and lower than Freq 2, and the current Stop Freq is greater than Freq 2, extend the first correction point at or above Freq 2 down to Freq 1, rather than using the correction data between Freq1 and Freq2.

The Antenna Unit row can only be used in Correction register 1, because there can only be one setting for Antenna Unit at any given time. If a Correction whose Antenna Unit is set to anything but None is loaded into any Correction register but 1, an error is generated (Mass storage error; Can only load an Antenna Unit into Correction 1). When a correction file is saved from any Correction register but 1, Antenna Unit is always written as None.

Similarly, the Bias rows can only be used in Correction register 1, because there can only be one setting for Bias at any given time. If a Correction file with a Bias or Bias State row is loaded into any Correction register but 1, an error is generated: Mass storage error; Can only load Bias Settings into Correction 1

The data follows the DATA row, as comma separated X, Y pairs; one pair per line.

For example, suppose you have an Antenna to correct for on an N9020A version A.02.06 and the correction data is:

- 0 dB at 200 MHz
- 17 dB at 210 MHz
- 14.8 dB at 225 MHz

Then the file will look like:

- Amplitude Correction
- "Correction Factors for 11966E"
- "Class B Radiated"
- A.02.06,N9020A
- P13 EA3 UK6,01
- Frequency Unit,MHz
- Antenna Unit,dBuV/m
- Frequency Interpolation,Linear
- DATA
- 200.000000,0.00
- 210.000000,17.00
- 225.000000,14.80

The choices for the 1 of N fields in the metadata are as follows:

- Frequency Unit: Hz, kHz, MHz, GHz
- Antenna Unit: dBuV/m, dBuA/m, dBG, dBpT, None

- Frequency Interpolation: Logarithmic, Linear

### Amplitude Correction

These keys let you choose which Correction to save. Once selected, the key returns back to the Export Data menu and the selected Correction number is annotated on the key.

The next step in the Save process is to select the Save As key in the Export Data menu.

Key Path	Save, Data, Amplitude Correction
Preset	Not part of a Preset, but is reset to Correction 1 by Restore Input/Output Defaults. Survives a shutdown.
Readback	1
Initial S/W Revision	A.02.00

### Trace

Pressing this key selects Traces as the data type to be exported. Pressing this key when it is already selected brings up the Trace Menu, which allows you to select which Trace to save.

The trace file contains “meta” data which describes the current setting of the analyzer, but it is not eh full state of the analyzer. The trace file content is detailed in:

["Frequency Scan Trace File Content" on page 847](#)

["Strip Chart Trace File Content" on page 848](#)

["Monitor Spectrum Trace File Content" on page 849](#)

Key Path	Save, Data
<b>Remote Command</b>	:MMEMory:STORe:TRACe:DATA TRACE1   TRACE2   TRACE3   ALL,<filename>
<b>Example</b>	:MMEM:STOR:TRAC:DATA TRACE2, "myTrace2.csv" exports the 2nd trace to the file myTrace2.csv in the current path. The default path is My Documents\EMI\data\xxx\Traces where xxx is the measurement name.
Notes	If the save is initiated via SCPI, and the file already exists, the file will be overwritten. Using the C: drive is strongly discouraged, since it runs the risk of being overwritten during an instrument software upgrade. Both single and double quotes are supported for any filename parameter over SCPI.
Dependencies	Traces cannot be recalled from a trace file that was saved with ALL traces selected.
Readback	1 2 3 All
Status Bits/OPC dependencies	Sequential - waits for previous measurement to complete
Initial S/W Revision	Prior to A.02.00

### Frequency Scan Trace File Content

The following file example shows the Trace file content in Excel for one trace.

Trace	
EMI:FSCAN	
A.07.00	N9020A
526 EA3 B25 P26 PFR	1
Preselector	
	On
Scan Type	
	Smooth
Number of scans	
	1
Y Axis Unit	
	dBuV
Ref Level Offset	
	0 dB
Coupling	
	AC
Input Z Correction	
	50 ohm
Data	
Trace	1
Detector	Peak
30000000	-91.67179747
30060002.47	-91.73843172
30120004.95	-88.07746798
30180007.42	-90.05428387
30240009.9	-86.55925246
30300012.37	-87.6724363
30360014.85	-93.18478677
30420017.32	-95.06361113
30480019.79	-91.02766645
30540022.27	-90.66836416
30600024.74	-87.10931161

### Strip Chart Trace File Content

The following file example shows the Trace file content in Excel.

AllTrace	
EMI:SHart	
A.07.00_R0009	N9020A
526 EA3 B25 P26 PFR	1



Frequency	600000000
Freq Offset	0
Attenuation	10
Y Axis Unit	dBuV
Ref Level Offset	0
Internal Preamp State	Off
Internal Preamp Band	Low
Resolution Bandwidth	120000
Dwell Time	0.05
Peak Hold	Infinite
Peak Hold Time	2
Max Duration	500

Data			
Trace	1	2	3
Detector	Peak	QuasiPeak	EmiAverage
Max	25.4396633	20.242876	12.356569
0	23.7515958	20.173686	12.282337
-0.05	24.6648769	20.194918	12.262222
-0.1	23.3178199	20.213507	12.253423
-0.15	23.5216423	20.221337	12.258119
-0.2	23.4602343	20.220859	12.262763
-0.25	23.5765176	20.212508	12.297994
-0.3	23.7032533	20.197088	12.325791
-0.35	24.825583	20.185434	12.332104
-0.4	23.6549108	20.186032	12.352822
-0.45	23.1558073	20.184001	12.356569
-0.5	23.8378283	20.171481	12.352344
-0.55	24.0481835	20.148553	12.329247
-0.6	23.7659679	20.165786	12.308906
-0.65	23.6379256	20.191835	12.330754
-0.7	23.1793252	20.20728	12.316628
-0.75	23.7241582	20.208026	12.324215
-0.8	24.0573294	20.205218	12.343919

### Monitor Spectrum Trace File Content

The following file example shows the Trace file content in Excel.

Trace	
EMI:MON	
A.13.00	N9038A
526 DP2 EMC LSN	1
Preselector	
	On
Y Axis Unit	
	dBuV
Ref Level Offset	
	0 dB
Coupling	
	AC
Input Z Correction	
	50 ohm
DATA	
Trace	1
Detector	Peak
29740009.9	9.302139008
29741009.9	9.609657014
29742009.9	9.945373261
29743009.9	10.28534671
29744009.9	10.59982272
29745009.9	10.84645816
29746009.9	10.97216769
29747009.9	10.93370792
29748009.9	10.70057651
29749009.9	10.21771213
29750009.9	9.474250519
29751009.9	8.374183381
29752009.9	6.909049714
29753009.9	4.86714145
29754009.9	2.253837311
29755009.9	-0.937874114
29756009.9	-4.154472625

## Limit

Pressing this key selects Limit Lines as the data type to be exported. Pressing the key a second time brings up the Limit Menu that allows you to select which **Limit Line** to save.

See "[Limits File Contents](#)" on page 851.

See ".csv file format" on page 851

See ".lim file format" on page 852

Key Path	Save, Data
Remote Command	:MMEMory:STORe:LIMit LLINE1   LLINE2   LLINE3   LLINE4   LLINE5   LLINE6, <filename>
Example	:MMEM:STOR:LIM LLINE2, "myLimitLine2.csv" saves the 2nd Limit Line to the file myLimitLine2.csv in the current path. The default path is My Documents\EMI\data\xxx\limits where xxx is the measurement name.
Notes	If the save is initiated via SCPI, and the file already exists, the file will be overwritten. Using the C: drive is strongly discouraged, since it runs the risk of being overwritten during an instrument software upgrade. Both single and double quotes are supported for any filename parameter over SCPI.
Dependencies	This key will only appear if you have the proper option installed in your instrument.
Preset	1; not part of Preset, but is reset by Restore Mode Defaults and survives power cycles
State Saved	The selected Limit number is saved in instrument state.
Readback	1 2 3 4 5 6
Status Bits/OPC dependencies	Sequential - waits for previous measurement to complete
Initial S/W Revision	A.02.00

### Limits File Contents

Limits may be exported into a data file with a .csv extension. They may be imported from that data file; they may also be imported from a legacy limit file with a .lim extension. The .lim files meet the specification for limit files contained in the EMI measurement guide, HP E7415A.

#### .csv file format

Except for information in quotes, limit line files are not case sensitive. Information in bold is required verbatim; other text is example text, and italic text is commentary which should not be present in the file.

The first five lines are system-required header lines, and must be in the correct order.

<b>Limit</b>	<i>Data file type name</i>
<b>"FCC Part 15"</b>	<i>File Description</i>
<b>"Class B Radiated"</b>	<i>Comment</i>
<b>A.01.00.R0001.N9020A</b>	<i>Instrument Version, Model Number</i>
<b>P13 EA3 UK6 .01</b>	<i>Option List, File Format Version</i>

The next few lines describe the parameters; on export they will be in the order shown, on import they can be in any order. If some parameters are missing, they will revert to the default.

Type, Upper	Upper Lower
X Axis Unit, MHz	MHz S; other units should be converted; this also specifies the domain
Amplitude Unit, dBm	dBm V; all other units should be converted appropriately
Frequency Interpolation, Linear	Logarithmic Linear
Amplitude Interpolation, Logarithmic	Logarithmic Linear
X Control, Fixed	Fixed Relative; on input we consider only the first three characters
Y Control, Fixed	Fixed Relative; on input we consider only the first three characters
Margin, 0	Always in dB. A 0 margin is equivalent to margin off
X Offset, 10	Expressed in the X axis units
Y Offset, 5	Expressed in the Amplitude units

The Amplitude Unit line in the limits file may contain an antenna factor unit, for example:

Amplitude Unit=dBuV/m

Antenna factor units are dBuV/m, dBuA/m, dBpT, and dBG. In this case, the unit is treated exactly as though it were dBuV, meaning that all of the limits are interpreted to have units of dBuV. The box does NOT change Y Axis Units when such a limit is loaded in.

The X axis unit also specifies the domain (time or frequency). It is not possible to have both time-domain lines and frequency-domain lines at the same time; if a time-domain line is imported while the other lines are in the frequency domain (or vice-versa), all limit lines will be deleted prior to import.

If the sign of the margin is inappropriate for the limit type (for example a positive margin for an upper limit), the sign of the margin will be changed internally so that it is appropriate.

The remaining lines describe the data. Each line in the file represents an X-Y pair. The X values should be monotonically non-decreasing, although adjacent lines in the file can have the same X value as an aid to building a stair-stepped limit line. To specify a region over which there is no limit, use +1000 dBm for upper limits or -1000 dBm for lower limits.

The data region begins with the keyword DATA:

DATA
200.000000,-10.00
300.000000,-10.00
300.000000,-20.00
500.000000,-20.00

### .lim file format

This is a legacy format which allows files saved from older analyzers to be loaded into the X-Series. Design of files in this format is not recommended.

### Save As . . .

When you press "Save As", the analyzer brings up a Windows dialog and a menu entitled "Save As." This menu allows you to navigate to the various fields in the Windows dialog without using a keyboard or mouse. The Tab and Arrow keys can also be used for dialog navigation.

See "To File . . ." on page 1096 in Save, State for a full description of this dialog and menu.

The default path for saving files is:

For all of the Trace Data Files:

My Documents\`<mode name>`\data\traces

For all of the Limit Data Files:

My Documents\<<mode name>\data\limits

For all of the Measurement Results Data Files:

My Documents\<<mode name>\data\<<measurement name>\results

For all of the Capture Buffer Data Files:

My Documents\<<mode name>\data\captureBuffer

Key Path	Save, Data
Mode	All
Notes	The key location is mode-dependent and will vary. Brings up the Save As dialog for saving a <mode specific> Save Type. The save is performed immediately and does not wait until the measurement is complete.
Initial S/W Revision	Prior to A.02.00

## Screen Image

Pressing Screen Image accesses a menu of functions that enable you to specify a format and location for the saved screen image. It brings up a menu that allows you to specify the color scheme of the Screen Image (Themes) or navigate to the Save As dialog to perform the actual save.

Screen Image files contain an exact representation of the analyzer display. They cannot be loaded back onto the analyzer, but they can be loaded into your PC for use in many popular applications.

The image to be saved is actually captured when the Save front panel key is pressed, and kept in temporary storage to be used if you ask for a Screen Image save. When the Screen Image key is pressed, a "thumbnail" of the captured image is displayed, as shown below:

## 10 Monitor Spectrum Measurement Save

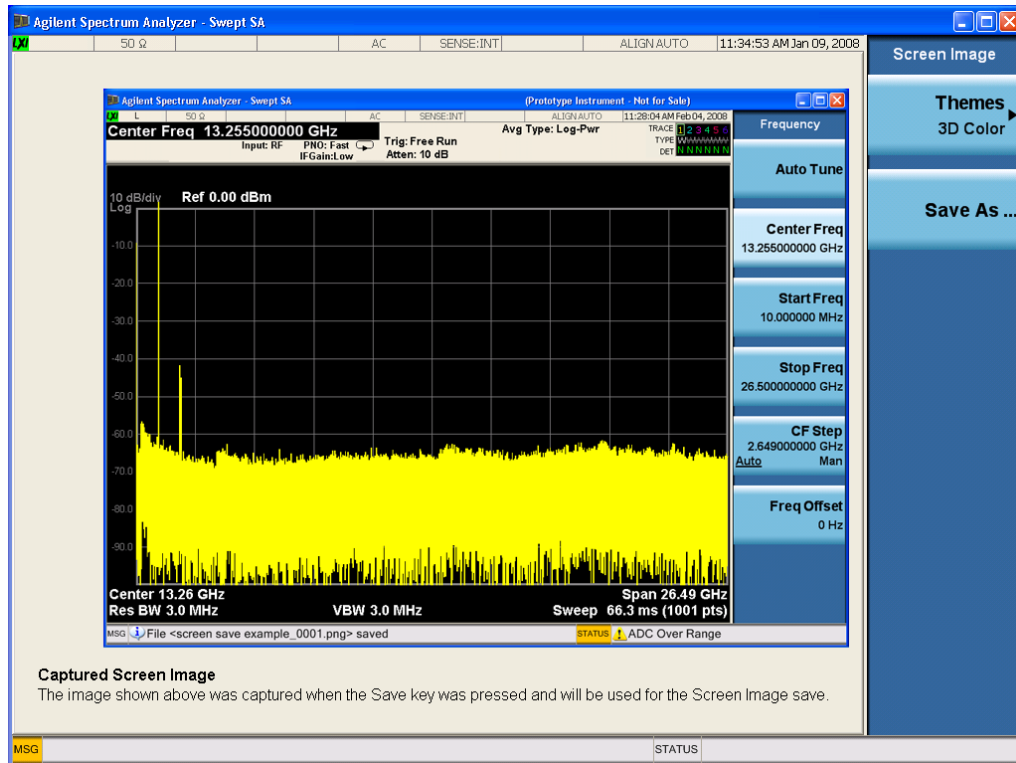

When you continue on into the Save As menu and complete the Screen Image save, the image depicted in the thumbnail is the one that gets saved, showing the menus that were on the screen before going into the Save menus. The save is performed immediately and does not wait until the measurement is complete.

After you have completed the save, the Quick Save front-panel key lets you quickly repeat the last save performed, using an auto-named file, with the current screen data.

### NOTE

For versions previous to A.01.55, if you initiate a screen image save by navigating through the Save menus, the image that is saved will contain the Save menu softkeys, not the menus and the active function that were on the screen when you first pressed the Save front panel key.

Key Path	Save
Mode	All
Remote Command	:MMEMory:STORe:SCReen <filename>
Example	:MMEM:STOR:SCR "myScreen.png" This stores the current screen image in the file MyScreenFile.png in the default directory.
Initial S/W Revision	Prior to A.02.00

## Themes

Accesses a menu of functions that enable you to choose the theme to be used when saving the screen image.

The **Themes** option is the same as the **Themes** option under the **Display** and **Page Setup** dialogs. It allows you to choose between themes to be used when saving the screen image.

<b>Key Path</b>	Save, Screen Image
<b>Remote Command</b>	:MMEMory:STORe:SCReen:THEMe TDColor   TDMonochrome   FCOLOR   FMONochrome  :MMEMory:STORe:SCReen:THEMe?
<b>Example</b>	:MMEM:STOR:SCR:THEM TDM
<b>Preset</b>	3D Color; Is not part of Preset, but is reset by Restore Misc Defaults or Restore System Defaults All and survives subsequent running of the modes.
<b>Readback</b>	3D Color   3D Mono   Flat Color   Flat Mono
<b>Backwards Compatibility Notes</b>	In ESA and PSA we offer the choice of "Reverse Bitmap" or "Reverse Metafile" when saving screen images. This is much like the "Flat Color" theme available in X-Series. Also, if you selected Reverse Bitmap AND a black & white screen image, that would be much like "Flat Monochrome". In other words, each of the X-Series themes has a similar screen image type in ESA/PSA. But they are not identical.
<b>Initial S/W Revision</b>	Prior to A.02.00

### 3D Color

Selects a standard color theme with each object filled, shaded and colored as designed.

<b>Key Path</b>	Save, Screen Image, Themes
<b>Example</b>	MMEM:STOR:SCR:THEM TDC
<b>Readback</b>	3D Color
<b>Initial S/W Revision</b>	Prior to A.02.00

### 3D Monochrome

Selects a format that is like 3D color but shades of gray are used instead of colors.

<b>Key Path</b>	Save, Screen Image, Themes
<b>Example</b>	MMEM:STOR:SCR:THEM TDM
<b>Readback</b>	3D Mono
<b>Initial S/W Revision</b>	Prior to A.02.00

### Flat Color

Selects a format that is best when the screen is to be printed on an ink printer.

<b>Key Path</b>	Save, Screen Image, Themes
-----------------	----------------------------

<b>Example</b>	MMEM:STOR:SCR:THEM FCOL
Readback	Flat Color
Initial S/W Revision	Prior to A.02.00

### Flat Monochrome

Selects a format that is like Flat Color. But only black is used (no colors, not even gray), and no fill.

Key Path	Save, Screen Image, Themes
<b>Example</b>	MMEM:STOR:SCR:THEM FMON
Readback	Flat Mono
Initial S/W Revision	Prior to A.02.00

### Save As...

When you press “Save As”, the analyzer brings up a Windows dialog and a menu entitled “**Save As.**” This menu allows you to navigate to the various fields in the Windows dialog without using a keyboard or mouse. The Tab and Arrow keys can also be used for dialog navigation.

See "[To File . . .](#)" on page 1096 in Save, State for a full description of this dialog and menu.

The default path for Screen Images is

My Documents\<<mode name>\screen.

where <mode name> is the parameter used to select the mode with the INST:SEL command (for example, SA for the Spectrum Analyzer).

Key Path	Save, Screen Image
Notes	Brings up Save As dialog for saving a Screen Image Save Type
Initial S/W Revision	Prior to A.02.00

### Mass Storage Catalog (Remote Command Only)

Key path	SCPI Only
<b>Remote Command</b>	:MMEMory:CATalog? [<directory_name>]
Notes	<p>The string must be a valid logical path.</p> <p>Queries disk usage information (drive capacity, free space available) and obtains a list of files and directories in a specified directory in the following format:</p> <p>&lt;numeric_value&gt;,&lt;numeric_value&gt;,{&lt;file_entry&gt;}</p> <p>It returns two numeric parameters and as many strings as there are files and directories. The first parameter indicates the total amount of storage currently used in bytes. The second parameter</p>



---

indicates the total amount of storage available, also in bytes. The <file\_entry> is a string. Each <file\_entry> indicates the name, type, and size of one file in the directory list:

<file\_name>,<file\_type>,<file\_size>

As the windows file system has an extension that indicates file type, <file\_type> is always empty. <file\_size> provides the size of the file in bytes. For directories, <file\_entry> is surrounded by square brackets and both <file\_type> and <file\_size> are empty

---

Initial S/W Revision      Prior to A.02.00

---

## Mass Storage Change Directory (Remote Command Only)

---

Key path                      SCPI Only

**Remote Command**        :MMEMory:CDIRectory [<directory\_name>]  
                                  :MMEMory:CDIRectory?

**Notes**                      The string must be a valid logical path.

Changes the default directory for a mass memory file system. The <directory\_name> parameter is a string. If no parameter is specified, the directory is set to the \*RST value.

At \*RST, this value is set to the default user data storage area, that is defined as System.Environment.SpecialFolder.Personal.

Query returns full path of the default directory.

---

Initial S/W Revision      Prior to A.02.00

---

## Mass Storage Copy (Remote Command Only)

---

Key path                      SCPI Only

**Remote Command**        :MMEMory:COPY <string>,<string>[,<string>,<string>]

**Notes**                      The string must be a valid logical path.

Copies an existing file to a new file or an existing directory to a new directory.

Two forms of parameters are allowed. The first form has two parameters. In this form, the first parameter specifies the source, and the second parameter specifies the destination.

The second form has four parameters. In this form, the first and third parameters specify the source. The second and fourth parameters specify the directories. The first pair of parameters specifies the source. The second pair specifies the destination. An error is generated if the source doesn't exist or the destination file already exists.

This command will generate an "access denied" error if the destination is a restricted folder (e.g., C:\Windows) and the current user does not have Power User or Administrator privileges.

---

## Mass Storage Device Copy (Remote Command Only)

This command transfers data to/from a file and a peripheral device.

Key path	SCPI Only
<b>Remote Command</b>	:MMEMory:COpy:DEvice <source_string>,<dest_string>
Notes	The strings must be a valid logical path or a valid device keyword. If the dest_string is a device keyword, the data is copied from the source file to the device. If the source_string is a device keyword, the data is copied to the source file from the device.  Valid device keywords are: SNS (smart noise source)  An error is generated if the file or device is not found.

### Mass Storage Delete (Remote Command Only)

Key path	SCPI Only
<b>Remote Command</b>	:MMEMory:DELeTe <file_name>[,<directory_name>]
Notes	The string must be a valid logical path.  Removes a file from the specified directory. The <file_name> parameter specifies the file name to be removed. This command will generate an "access denied" error if the file is in a restricted folder (e.g., C:\Windows) and the current user does not have Power User or Administrator privileges.
Initial S/W Revision	Prior to A.02.00

### Mass Storage Data (Remote Command Only)

Creates a file containing the specified data OR queries the data from an existing file.

Key path	SCPI Only
<b>Remote Command</b>	:MMEMory:DATA <file_name>, <data> :MMEMory:DATA? <file_name>
Notes	The string must be a valid logical path.  The command form is MMEMory:DATA <file_name>,<data>. It loads <data> into the file <file_name>. <data> is in 488.2 block format. <file_name> is string data.  The query form is MMEMory:DATA? <file_name> with the response being the associated <data> in block format.
Initial S/W Revision	Prior to A.02.00

### Mass Storage Make Directory (Remote Command Only)

Key path	SCPI Only
<b>Remote Command</b>	:MMEMory:MDIRectory <directory_name>
Notes	The string must be a valid logical path.  Creates a new directory. The <directory_name> parameter specifies the name to be created.

	This command will generate an “access denied” error if the new directory would be in a restricted folder (e.g., C:\Windows) and the current user does not have Power User or Administrator privileges.
Initial S/W Revision	Prior to A.02.00

### Mass Storage Move (Remote Command Only)

Key path	SCPI Only
<b>Remote Command</b>	:MMEMory:MOVE <string>,<string>[,<string>,<string>]
Notes	<p>The string must be a valid logical path.</p> <p>Moves an existing file to a new file or an existing directory to a new directory.</p> <p>Two forms of parameters are allowed. The first form has two parameters. In this form, the first parameter specifies the source, and the second parameter specifies the destination.</p> <p>The second form has four parameters. In this form, the first and third parameters specify the source. The second and fourth parameters specify the directories. The first pair of parameters specifies the source. The second pair specifies the destination. An error is generated if the source doesn't exist or the destination file already exists.</p> <p>This command will generate an “access denied” error if the destination is a restricted folder (e.g., C:\Windows) and the current user does not have Power User or Administrator privileges.</p>
Initial S/W Revision	Prior to A.02.00

### Mass Storage Remove Directory (Remote Command Only)

Key path	SCPI Only
<b>Remote Command</b>	:MMEMory:RDIRECTory <directory_name>
Notes	<p>The string must be a valid logical path.</p> <p>Removes a directory. The &lt;directory_name&gt; parameter specifies the directory name to be removed. All files and directories under the specified directory shall also be removed.</p> <p>This command will generate an “access denied” error if the folder is a restricted folder (e.g., C:\Windows) or is in a restricted folder and the current user does not have Power User or Administrator privileges.</p>
Initial S/W Revision	Prior to A.02.00

## Single (Single Measurement/Sweep)

Sets the analyzer for Single measurement operation. The single/continuous state is Meas Global, so the setting will affect all the measurements. If you are Paused, pressing Single does a Resume.

See ["More Information" on page 860](#)

Key Path	Front-panel key
Example	:INIT:CONT OFF
Notes	See Cont key description.
Backwards Compatibility Notes	<p>For Spectrum Analysis mode in ESA and PSA, the Single hardkey and the INITiate:IMM switched from continuous measurement to single measurement and restarted sweeps and averages (displayed average count reset to 1), but did not restart Max Hold and Min Hold. In the X-Series, the Single hardkey and the INITiate:IMM command initiate a sweep/ measurement/ average sequence/hold sequence including MaxHold and MinHold.</p> <p>For Spectrum Analysis mode in ESA and PSA, the Single hardkey restarted the sweep regardless of whether or not you were in an active sweep or sweep sequence. In the X-Series, Restart does this but Single only restarts the sweep or sweep sequence if you are in the idle state.</p> <p>INIT[:IMM] in ESA &amp; PSA Spectrum Analysis Mode does an implied ABORT. In some other PSA Modes, INIT[:IMM] is ignored if not in the idle state. . The X-Series follows the ESA/PSA SA Mode model, which may cause some Modes to have compatibility problems.</p>
Initial S/W Revision	Prior to A.02.00

### More Information

See ["Restart" on page 1093](#) for details on the INIT:IMMEDIATE (Restart) function.

If you are already in single sweep, the INIT:CONT OFF command has no effect.

If you are already in Single Sweep, then pressing the Single key in the middle of a sweep does not restart the sweep or sequence. Similarly, pressing the Single key does not restart the sweep or sequence if the sweep is not in the idle state (for example, if you are taking a very slow sweep, or the analyzer is waiting for a trigger). Instead, it results in a message. "Already in Single, press Restart to initiate a new sweep or sequence". Even though pressing the Single key in the middle of a sweep does not restart the sweep, sending INIT:IMMEDIATE does reset it.

To take one more sweep without resetting the average count, increment the average count by 1, by pressing the step up key while **Average/Hold Number** is the active function, or sending the remote command CALC:AVER:TCON UP.

## Source

There is no Source control functionality for this measurement. When this key is pressed, the screen either displays a blank menu, or the previously-selected menu remains unchanged.

---

Key Path	Front-panel key
----------	-----------------

---

## SPAN X Scale

Displays the menu keys that enable you to control the span parameters.

Key Path	Front-panel key
Initial S/W Revision	A.13.00

### Span

Sets the span of the Spectrum display.

Key Path	SPAN X Scale
<b>Remote Command</b>	[ :SENSe ] :MONitor:FREQuency:SPAN <frequency> [ :SENSe ] :MONitor:FREQuency:SPAN?
<b>Example</b>	MON:FREQ:SPAN 1 MHZ MON:FREQ:SPAN?

**Dependencies** Span can be selected between 1 kHz and 10 MHz in steps of 1, 2 and 5. The span is dependent on both the Meters RBW and the Spectrum RBW as shown below.  
Meters RBW: for most Meters RBW's, the max Span is 10 times the Meters RBW. The exact limits are shown below.

1 MHz	10 MHz
120 kHz	10 MHz
100 kHz	10 MHz
10 kHz	2 MHz
9 kHz	1 MHz
1 kHz	200 kHz
200 Hz	20 kHz
100 Hz	20 kHz
10 Hz	2 kHz

Spectrum RBW is limited to specific ranges depending on the Span, as shown below.

10 MHz	10 kHz - 100 kHz
5 MHz	10 kHz - 100 kHz
2 MHz	1 kHz - 10 kHz
1 MHz	1 kHz - 10 kHz
500 kHz	300 Hz - 3 kHz

200 kHz	100 Hz – 1 kHz
100 kHz	100 Hz – 1 kHz
50 kHz	30 Hz – 300 Hz
20 kHz	10 Hz – 100 Hz
10 kHz	10 Hz – 100 Hz
5 kHz	10 Hz – 30 Hz
2 kHz	10 Hz – 30 Hz
1 kHz	10 Hz – 30 Hz

Preset	1 MHz
State Saved	Saved in instrument state
Min	1 kHz
Max	10 MHz
Default Unit	Hz
Status Bits/OPC dependencies	non-overlapped
Initial S/W Revision	A.13.00

## Last Span

Changes the displayed frequency span to the previous span setting. If it is pressed immediately after Signal Track is turned off, then the span setting returns to the span that was in effect before Signal Track was turned on.

Key Path	SPAN X Scale
<b>Remote Command</b>	[ :SENSe ] :MONitor :FREQuency :SPAN :PREVious
<b>Example</b>	:MON:FREQ:SPAN:PREV sets the span to the previous value
Initial S/W Revision	A.13.00

## Sweep/Control

Displays the menu keys that enable you to control the sweep/control parameters.

Key Path	Front-panel key
Initial S/W Revision	A.13.00

### Clear List And Restart

This key will perform the following when pressed:

1. Prompt you for confirmation to delete all signals in signal list with the following message:

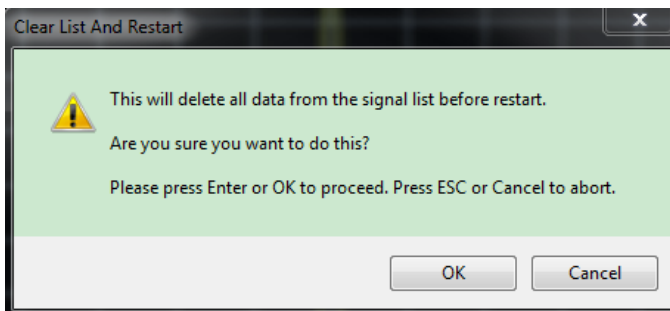

2. After confirmation, restart the measurement.

Key Path	Sweep/Control
<b>Remote Command</b>	INITiate:MONitor:CLEar:IMMediate
<b>Example</b>	INIT:MON:CLE:IMM
Initial S/W Revision	A.13.00



## System

See "System" on page 272

## Trace/ Detector

Displays a menu of keys that enable you to control the trace setting for the Spectrum Window.

The traces in the Spectrum display contain 2001 points.

For more information see:

["Trace Annunciator Panel" on page 866](#)

Key Path	Front-panel key
<b>Remote Command</b>	:TRACe[1] 2 3:MONitor:TYPE WRITe AVERage MAXHold MINHold :TRACe[1] 2 3:MONitor:TYPE?
<b>Notes</b>	WRITe = Clear Write AVERage = Trace Average MAXHold = Maximum Hold MINHold = Minimum Hold
<b>Couplings</b>	Selecting a trace type (pressing any of the four keys or sending a TRAC:TYPE command) puts Update in On and Display in On, even if that trace type was already selected.
<b>Preset</b>	WRITe
<b>State Saved</b>	The type of each trace is saved in Instrument State
<b>Initial S/W Revision</b>	Prior to A.13.00

### Trace Annunciator Panel

The trace annunciator panel appears on the right hand side of the Meas Bar. Here is an explanation of the fields in this panel:



On the line labeled “TRACE”, each trace number is shown, in the trace color. A green box is drawn around the currently selected trace

Below each trace number, on the line labeled “TYPE”, is a letter signifying the trace type for that trace number, where

W=Clear Write

A=Trace Average

M=Max Hold

m=Min Hold

If the letter is white it means the trace is being updated (Update = On); if the letter is dimmed , it means the trace is not being updated (Update = Off). A strikethrough (e.g., W) indicates that the trace is blanked (Display = Off). Note that it is possible for a trace to be updating and blanked, which is useful if the trace is a trace math component.

The third line, labeled “DET”, shows the detector type for each trace. In Monitor Spectrum the detector is always Sample, so the letter S is always shown here.

### Select Trace

Specifies the selected trace. The “selected trace” is the trace that other parameters under the Trace/Detector menu will apply to.

Key Path	Trace/ Detector
Notes	Front panel only. The selected trace is remembered even when not in the Trace/ Det Menu.
Preset	Trace 1, not affected by Mode Preset, preset by Restore Mode Defaults.
Initial S/W Revision	A.13.00

### Clear Write

In Clear Write type each trace update replaces the old data in the trace with new data. Pressing the Clear Write key for the selected trace, or sending the TRAC:TYPE WRIT command for the specified trace, sets the trace type to Clear Write and causes the trace to be cleared, even if you are already in Clear Write. Then a new sweep is initiated.

When Clear Write is pressed for one trace, Trace Average, Max Hold and Min Hold restart for all traces.

When in Clear Write, if a “Force restart” setting is changed, the trace is cleared and a new sweep is initiated.

Key Path	Trace/Detector
<b>Example</b>	:TRAC:MON:TYPE WRIT
Couplings	Whenever you press Clear Write or send the equivalent SCPI command, Update is set to On and Display is set to On.
Preset	After a Preset, any trace that is in Clear Write is cleared (all trace points set to mintracevalue).
State Saved	The type for each trace is saved in instrument state
Initial S/W Revision	A.13.00

### Trace Average

In Trace Average type the analyzer maintains and displays an average trace, which represents the cumulative average on a point-by-point basis of the new trace data and averaged trace data from the previous 9 traces.

When in Trace Average, if a “Force restart” setting is changed, the trace is cleared and a new sweep is initiated.

Averaging is always done on the Voltage scale, meaning that the averaging process works on the voltage of the envelope of the signal. In the equation for averaging on this scale (below), K is the number of averages accumulated.

$$\text{New avg} = 20 \log \left( \frac{1}{K} \left( (K-1) \left( 10^{\text{Old avg}/20} \right) + 10^{\text{New data}/20} \right) \right)$$

This equation assumes all values are in the decibel scale. Note that in continuous sweep mode, once K has reached 10, then K stays at that value for subsequent sweeps. In single sweep mode, once K has reached 10, the sweep stops.

Key Path	Trace/Detector
<b>Example</b>	:TRAC2:MON:TYPE AVER
Notes	Pressing the Trace Average key (for the selected trace), or sending the TRAC:TYPE AVER command (for the specified trace), sets the trace type to Trace Average and causes the average to be restarted. Restarting the average means: <ul style="list-style-type: none"> <li>• The average/hold count k is set to 1, so that the next time the average trace is displayed it simply represents one trace of new data</li> <li>• A new sweep is initiated.</li> <li>• Once the new sweep starts, the trace is overwritten with current trace data as the first trace of the new average</li> </ul>
Couplings	Whenever you press Trace Average or send the equivalent SCPI command, Update is set to On and Display is set to On.
Preset	After a Preset, any trace that is in Trace Average is cleared (all trace points set to mintracevalue).
State Saved	The type for each trace is saved in Instrument State
Initial S/W Revision	A.13.00

## Max Hold

In Max Hold type the analyzer maintains and displays a max hold trace, which represents the maximum data value on a point-by-point basis of the new trace data and previous trace data.

Pressing the Max Hold key for the selected trace, or sending the :TRAC:TYPE MAXH command for the specified trace, sets the trace type to Max Hold, causes the trace to be cleared, and causes the Max Hold sequence to be (re)started, even if you are already in Max Hold.

**NOTE** Pressing Restart does not restart the Max Hold.

When in Max Hold, if a “Force restart” setting is changed, the trace is cleared and a new sweep is initiated.

Key Path	Trace/Detector
<b>Example</b>	:TRAC3:MON:TYPE MAXH
Preset	After a Preset, any trace that is in Max Hold is cleared (all trace points set to mintracevalue).
State Saved	The type for each trace is saved in Instrument State
Initial S/W Revision	A.13.00

## Min Hold

In Min Hold type the analyzer maintains and displays a min hold trace, which represents the minimum data value on a point-by-point basis of the new trace data and previous trace data.

Pressing the Min Hold key for the selected trace, or sending the `:TRAC:TYPE MINH` command for the specified trace, sets the trace type to Min Hold, causes the trace to be cleared, and causes the Min Hold sequence to be (re)started, even if you are already in Max Hold.

**NOTE** Pressing Restart does not restart the Min Hold.

When in Min Hold, if a “Force restart” setting is changed, the trace is cleared and a new sweep is initiated.

Key Path	Trace/Detector
<b>Example</b>	<code>:TRAC3:MON:TYPE MINH</code>
Preset	After a Preset, any trace that is in Min Hold is cleared (all trace points set to maxtracevalue).
State Saved	The type for each trace is saved in Instrument State
Initial S/W Revision	A.13.00

## View/Blank

This key lets you set the state of the two trace variables, Update and Display. The four choices available in this 1-of-N menu are:

- Trace On: Update and Display both On
- View: Update Off and Display On
- Blank: Update Off and Display Off
- Background: Update On, Display Off (this allows a trace to be blanked and continue to update “in the background”, which was not possible in the past)

A trace with Display Off is indicated by a strikethrough thru the type letter in the trace annotation panel in the Measurement bar. A trace with Update Off is indicated by dimming the type letter in the trace annotation panel in the Measurement bar. So in the example below, Traces 2 and 3 have Update Off and Display Off.



See ["Trace Update State On/Off"](#) on page 870.

See ["Trace Display State On/Off"](#) on page 870.

See ["More Information"](#) on page 871.

Key Path	Trace/Detector
----------	----------------

Notes	<p>The four states of this 1-of-N actually set two variables, Update and Display, to their four possible combinations:</p> <ul style="list-style-type: none"> <li>• Trace On: Update and Display both On</li> <li>• View: Update Off and Display On</li> <li>• Blank: Update Off and Display Off</li> <li>• Background: Update On, Display Off</li> </ul> <p>See tables below for detail on the SCPI to control these two variables.</p>
Couplings	<p>Selecting a trace type (Clear Write, Trace Average, Max Hold, Min Hold) for a trace (pressing the key or sending the equivalent SCPI command) puts the trace in Trace On (Update On and Display On), even if that trace type was already selected.</p> <p>Loading a trace from a file puts that trace in View regardless of the state it was in when it was saved; as does being the target of a Copy or a participant in an Exchange.</p>
Initial S/W Revision	A.13.00

### Trace Update State On/Off

Key Path	Trace/Detector
<b>Remote Command</b>	:TRACe[1] 2 3:MONitor:UPDate[:STATE] ON OFF 0 1 :TRACe[1] 2 3:MONitor:UPDate[:STATE]?
<b>Example</b>	:TRAC2:MON:UPD 0 Makes trace 2 inactive (stops updating)
Couplings	Whenever you set Update to On for any trace, the Display is set to On for that trace.
Preset	1 0 0 (On for Trace 1; Off for 2-3)
State Saved	Saved in Instrument State
Initial S/W Revision	Prior to A.13.00

### Trace Display State On/Off

Key Path	Trace/Detector
<b>Remote Command</b>	:TRACe[1] 2 3:MONitor:DISPlay[:STATE] ON OFF 0 1 :TRACe[1] 2 3:MONitor:DISPlay[:STATE]?
<b>Example</b>	:TRAC2:MON:DISP 1 Makes trace 2 visible :TRAC3:MON:DISP 0 Blanks trace 3
Couplings	Whenever you set Update to On for any trace, the Display is set to On for that trace.
Preset	1 0 0 (On for Trace 1; Off for 2-3)
State Saved	Saved in instrument state
Initial S/W Revision	A.13.00

## More Information

When a trace becomes inactive, the following things happen:

- Any update from the SENSE system (detectors) immediately stops (does not wait for end of sweep)
- the trace is displayed at half intensity (as long as it stays inactive)

Inactive traces display across the entire X Axis of the instrument. Their horizontal placement does not change even if X Axis settings subsequently are changed, although Y-axis settings will affect the vertical placement of data.

In most cases, inactive traces are static and unchanging; however, there are cases when an inactive trace will update, specifically:

- if trace data is loaded from mass storage
- if the trace is the target of a Copy

When a trace becomes active (Update=On), the trace is cleared, the average count is reset, and a new sweep is initiated.

Traces which are blanked (Display=off) do not display nor appear on printouts but are otherwise unaffected. They may be queried and markers may be placed on them.

Note that the action of putting a trace in Display=Off and/or Update=Off does not restart the sweep and does not restart Averaging or Hold functions for any traces.

Note also that whenever you set Update to On for any trace, Display is set to On for that trace.

### Copy Trace 1 To Trace 2

This function copies the trace data from Trace 1 to Trace 2 and puts trace 2 into View (Update=Off, Display=On).

Key Path	Trace/Detector
<b>Example</b>	TRAC:MON:COPY TRACE1,TRACE2
Initial S/W Revision	Prior to A.13.00

### Copy Trace 1 To Trace 3

This function copies the trace data from Trace 1 to Trace 3 and puts trace 3 into View (Update=Off, Display=On).

Key Path	Trace/Detector
<b>Example</b>	TRAC:MON:COPY TRACE1,TRACE3
Initial S/W Revision	Prior to A.13.00

## Copy Trace (Remote Command Only)

<b>Remote Command</b>	:TRACe:MONitor:COPIY TRACE1   TRACE2   TRACE3, TRACE1   TRACE2   TRACE3
<b>Example</b>	TRAC:MON:COPIY TRACE1, TRACE3 copies Trace 1 to Trace 3 and puts Trace 3 in Update=Off, Display=On
<b>Notes</b>	The TRACe:MONitor:COPIY command is of the form: :TRACe:MONitor:COPIY <source_trace>,<dest_trace>
<b>Notes</b>	In the case of a Copy, the destination trace is put in Update=Off, Display=On after the copy.
<b>Initial S/W Revision</b>	Prior to A.13.00

## Send/Query Trace Data (Remote Command Only)

This command allows trace data to be sent to the analyzer or queried from the instrument. The response to the query is a list of amplitude points that comprise the requested trace in the current Y Axis Unit of the instrument. The X Axis Unit is that of the destination trace (for send) or the source trace (for query).

The traces in the Spectrum display contain 2001 points.

<b>Remote Command</b>	:TRACe:MONitor[:DATA] TRACE1 TRACE2 TRACE3,<data>
<b>Example</b>	TRAC:MON TRACE1, -1, -2, -3, -4, -5 Sends five points to Trace 1. Assuming that FORMat:DATA is set to ASCII, Y Axis Unit is set to dBm, and sweep points is set to 5, this will result in Trace 1 consisting of the five points -1 dBm, -2 dBm, -3 dBm, -4 dBm, and -5 dBm.
<b>Remote Command Notes</b>	The TRACe:MONitor[:DATA] command is of the form: :TRACe:MONitor:DATA <trace>,<data> where <trace> can be one of the following parameters: TRACE1,TRACE2,TRACE3 and where <data> can be - ASCII data, which consists of a string of values separated by comma or - REAL or INTeger sent as a definite length block, with a header describing the data to follow.
<b>Couplings</b>	Sweep points will affect the amount of data The FORMat:DATA command describes the different types of data formats that can be used with trace data. Use the FORMat:BORDER command to set the byte order.
<b>Backwards Compatibility SCPI</b>	:TRACe[:DATA] TRACE1 TRACE2 TRACE3
<b>Backwards Compatibility SCPI Notes</b>	This command is included for ESU compatibility. The command is Meas Local and Context Sensitive.
<b>Initial S/W Revision</b>	A.13.00

<b>Remote Command</b>	:TRACe:MONitor[:DATA]? TRACE1   TRACE2   TRACE3  SINGLE
<b>Example</b>	TRAC:MON? TRACE2 Queries the analyzer for the contents of trace 2.



Remote Command Notes	When TRACE1, the latest contents of trace 1 will be returned. When TRACE2, the latest contents of trace 2 will be returned. When TRACE3, the latest contents of trace 3 will be returned. When SINGLE, the current power values of all activated meters are returned separated by commas in the order meters number.
<b>Backwards Compatibility SCPI</b>	:TRACe[:DATA]?
Backwards Compatibility SCPI Notes	This command is included for ESU compatibility. The SCPI is Meas Local and Context Sensitive.
Initial S/W Revision	A.13.00

### Trace Display (Remote Command Only)

This SCPI sets the state of the trace's Update state.

<b>Remote Command</b>	DISPlay[:WINDow]:TRACe[1] 2 3[:STATe] ON OFF 1 0 DISPlay[:WINDow]:TRACe[1] 2 3[:STATe]?
<b>Example</b>	DISP:TRAC OFF DISP:TRAC?
Notes	This command is included for ESU compatibility. The suffix [1]2 and [1]2 3 are irrelevant to the measurement, they are added solely for remote language compatibility. This SCPI alias to :TRACe[1] 2 3:MONitor:UPDate ON OFF 1 0.
<b>Backwards Compatibility SCPI</b>	DISPlay:WINDow[1] 2:TRACe[1] 2 3[:STATe]
Initial S/W Revision	A.13.00

## Trigger

See ["Trigger" on page 358](#)

### Free Run

See ["Free Run " on page 365](#)

### Video

See ["Video \(IF Envelope\) " on page 366](#)

### Trigger Level

See ["Trigger Level " on page 366](#)

### Trig Slope

See ["Trig Slope " on page 367](#)

### Trig Delay

See ["Trig Delay " on page 368](#)

### External 1

See ["External 1 " on page 369](#)

### Trigger Level

See ["Trigger Level " on page 370](#)

### Trig Slope

See ["Trig Slope " on page 370](#)

### Trig Delay

See ["Trig Delay " on page 371](#)

### Zero Span Delay Comp

See ["Zero Span Delay Comp On/Off" on page 372](#)

### External 2

See ["External 2 " on page 372](#)

### Trigger Level

See ["Trigger Level " on page 373](#)

### Trig Slope

See ["Trig Slope " on page 373](#)

### **Trig Delay**

See "Trig Delay " on page 374

### **Zero Span Delay Comp**

See "Zero Span Delay Comp On/Off" on page 374

### **Auto/Holdoff**

See "Auto/Holdoff " on page 375

### **Auto Trig**

See "Auto Trig " on page 375

### **Trig Holdoff**

See "Trig Holdoff " on page 376

## User Preset

Accesses a menu that gives you the following three choices:

- User Preset – recalls a state previously saved using the Save User Preset function.
- User Preset All Modes – presets all of the modes in the analyzer
- Save User Preset– saves the current state for the current mode

Key Path	Front-panel key
Backwards Compatibility Notes	<p>User Preset is actually loading a state, and in legacy analyzers, it was possible to load a state without affecting the trace data, limit lines or correction data. Similarly it was possible to do a User Preset without affecting the trace data, limit lines or correction data.</p> <p>In the X-Series, “state” always includes all of this data; so whenever state is loaded, or User Preset is executed, all of the traces, limit lines and corrections are affected. Although this differs from previous behavior, it is desirable behavior, and should not cause adverse issues for users.</p> <p>On ESA and PSA, User Preset affected the entire instrument’s state. In the X-Series, User Preset only recalls the state for the active mode. There is a User Preset file for each mode. User Preset can never cause a mode switch as it can in legacy analyzers. If you want to recall all modes to their user preset file state, you will need to do a User Preset after mode switching into each mode.</p> <p>User Preset recalls mode state which can now include data like traces; whereas on ESA and PSA, User Preset did not affect data.</p>
Initial S/W Revision	Prior to A.02.00

## User Preset

User Preset sets the state of the currently active mode back to the state that was previously saved for this mode using the Save User Preset menu key or the SCPI command, SYST:PRES:USER:SAV. It not only recalls the Mode Preset settings, but it also recalls all of the mode persistent settings, and the Input/Output system setting that existed at the time Save User Preset was executed.

If a Save User Preset has not been done at any time, User Preset recalls the default user preset file for the currently active mode. The default user preset files are created if, at power-on, a mode detects there is no user preset file. There will never be a scenario when there is no user preset file to restore. For each mode, the default user preset state is the same state that would be saved if a Save User Preset is performed in each mode right after doing a Restore Mode Default and after a Restore Input/Output Defaults.

The User Preset function does the following:

- Aborts the currently running measurement.
- Sets the mode State to the values defined by Save User Preset.
- Makes the saved measurement for the currently running mode the active measurement.
- Brings up the saved menu for the power-on mode.
- Clears the input and output buffers.
- Sets the Status Byte to 0.

Key Path	User Preset
Remote Command	:SYSTem:PRESet:USER
Example	:SYST:PRES:USER:SAVE:SYST:PRES:USER
Notes	:SYST:PRES:USER:SAVE is used to save the current state as the user preset state. Clears all pending OPC bits. The Status Byte is set to 0. Pressing the User Preset front-panel key while already in the User Preset menu will cause the User Preset to get executed
Couplings	A user preset will cause the currently running measurement to be aborted and cause the saved measurement to be active. Recalling a User Preset file has the same issues that recalling a Save State file has. Some settings may need to be limited and therefore re-coupled, since the capabilities of the mode may have changes when the User Preset file was last saved.
Initial S/W Revision	Prior to A.02.00

## User Preset All Modes

Recalls all of the User Preset files for each mode, switches to the power-on mode, and activates the saved measurement from the power-on mode User Preset file.

**NOTE**

When the instrument is secured, all of the user preset files are converted back to their default user preset files.

The User Preset function does the following:

- Aborts the currently running measurement.
- Switches the Mode to the power-on mode.
- Restores the User Preset files for each mode.
- Makes the saved measurement for the power-on mode the active measurement.
- Brings up the saved menu for the power-on mode.
- Clears the input and output buffers.
- Sets the Status Byte to 0.

Key Path	User Preset
Remote Command	:SYSTem:PRESet:USER:ALL
Example	:SYST:PRES:USER:SAVE:SYST:PRES:USER:ALL
Notes	Clears all pending OPC bits. The Status Byte is set to 0. :SYST:PRES:USER:SAVE is used to save the current state as the user preset state.
Couplings	A user preset will cause the currently running measurement to be aborted, cause a mode switch to the power-on mode, and cause the saved measurement to be active in the power-on mode. Recalling a User Preset file has the same issues that recalling a Save State file has. Some settings may need to be limited and therefore re-coupled, since the capabilities of the mode may have changes when the User Preset file was last saved.
Initial S/W Revision	Prior to A.02.00

## Save User Preset

Saves the currently active mode and its State. You can recall this User Preset file by pressing the User Preset menu key or sending the SYST:PRES:USER remote command. This same state is also saved by the Save State function.

Key Path	User Preset
Remote Command	:SYSTem:PRESet:USER:SAVE
Example	:SYST:PRES:USER:SAVE
Notes	:SYST:PRES:SAVE creates the same file as if the user requested a *SAV or a MMEM:STOR:STAT, except User Preset Save does not allow the user to specify the filename or the location of the file.
Initial S/W Revision	Prior to A.02.00

## View/Display

The View/Display key opens the Display and View menus.

Key Path	Front-panel key
Initial S/W Revision	A.13.00

### Display

The Display menu is common to most measurements, and is used for configuring items on the display. Some Display menu settings apply to all the measurements in a mode, and some only to the current measurement. Those under the System Display Settings key apply to all measurements in all modes.

Key Path	Display
Key Path	View/Display
Initial S/W Revision	Prior to A.02.00

### Annotation

Turns on and off various parts of the display annotation. The annotation is divided up into four categories:

1. Meas Bar: This is the measurement bar at the top of the screen. It does not include the settings panel or the Active Function. Turning off the Meas Bar turns off the settings panel and the Active Function. When the Meas Bar is off, the graticule area expands to fill the area formerly occupied by the Meas Bar.
2. Screen Annotation: this is the annotation and annunciation around the graticule, including any annotation on lines (such as the display line, the threshold line, etc.) This does NOT include the marker number or the N dB result. When off, the graticule expands to fill the entire graticule area.
3. Trace annotation: these are the labels on the traces, showing their detector (or their math mode).
4. Active Function annotation: this is the active function display in the meas bar, and all of the active function values displayed on softkeys.

See the figure below. Each type of annotation can be turned on and off individually.

10 Monitor Spectrum Measurement  
View/Display

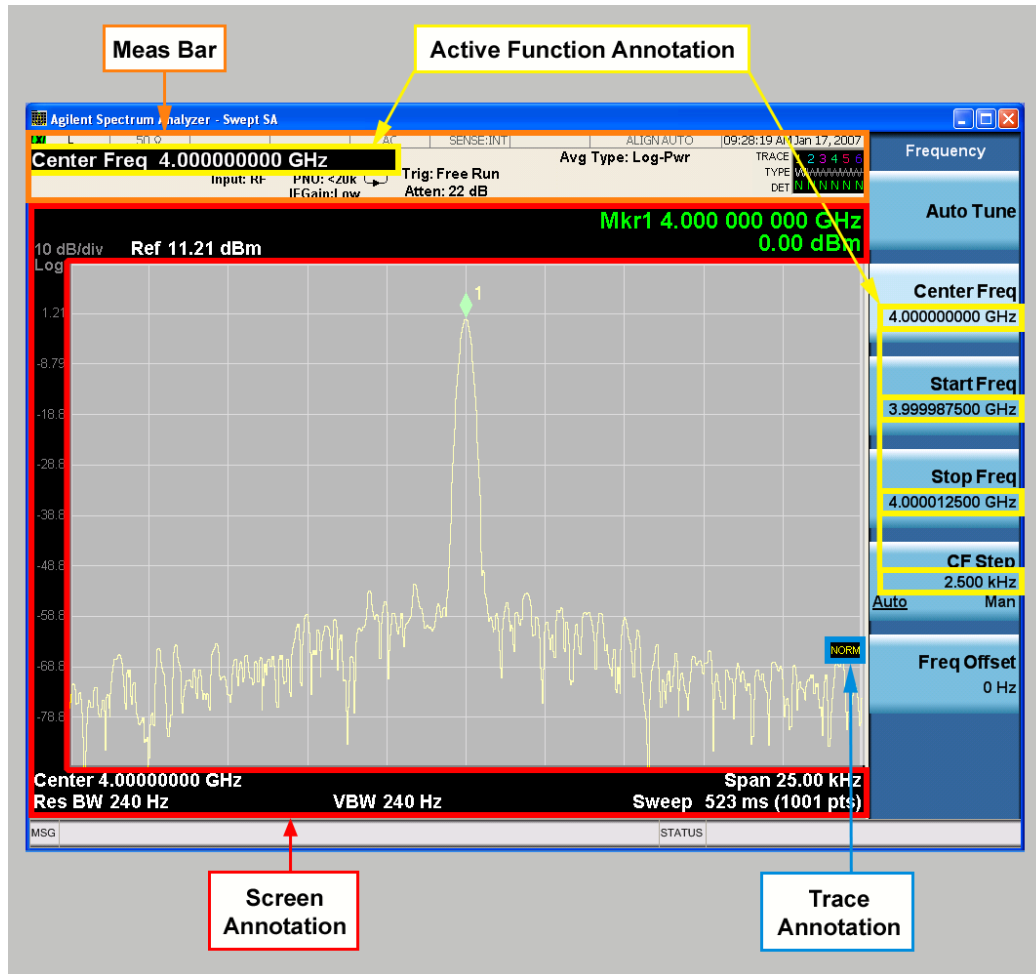

Key Path	View/Display, Display
Initial S/W Revision	Prior to A.02.00

Meas Bar On/Off

This function turns the Measurement Bar on and off, including the settings panel. When off, the graticule area expands to fill the area formerly occupied by the Measurement Bar.

Key Path	View/Display, Display, Annotation
Remote Command	:DISPlay:ANNOtation:MBAR[:STATe] OFF ON 0 1 :DISPlay:ANNOtation:MBAR[:STATe]?
Example	DISP:ANN:MBAR OFF
Dependencies	Grayed out and forced to OFF when System Display Settings, Annotation is set to Off.
Preset	On This should remain Off through a Preset when System Display Settings, Annotation is set to Off.
State Saved	Saved in instrument state.
Initial S/W Revision	Prior to A.02.00



## Screen

This controls the display of the annunciation and annotation around the graticule, including any annotation on lines (such as the display line, the threshold line, etc.) and the y-axis annotation. This does NOT include marker annotation (or the N dB result). When off, the graticule expands to fill the entire graticule area, leaving only the 1.5% gap above the graticule as described in the Trace/Detector chapter.

Key Path	View/Display, Display, Annotation
Remote Command	:DISPlay:ANNotation:SCReen[:STATe] OFF ON 0 1 :DISPlay:ANNotation:SCReen[:STATe]?
Example	DISP:ANN:SCR OFF
Dependencies	Grayed-out and forced to OFF when System Display Settings, Annotation is set to Off.
Preset	On This should remain Off through a Preset when System DisplaySettings, Annotation is set to Off
State Saved	Saved in instrument state.
Initial S/W Revision	Prior to A.02.00

## Trace

Turns on and off the labels on the traces, showing their detector (or their math mode) as described in the Trace/Detector section.

If trace math is being performed with a trace, then the trace math annotation will replace the detector annotation.

Key Path	View/Display, Display, Annotation
Remote Command	:DISPlay:ANNotation:TRACe[:STATe] ON OFF 1 0 :DISPlay:ANNotation:TRACe[:STATe]?
Example	DISP:ANN:TRAC OFF
Preset	Off
State Saved	Saved in instrument state.
Initial S/W Revision	Prior to A.02.00

## Active Function Values On/Off

Turns on and off the active function display in the Meas Bar, and all of the active function values displayed on the softkeys.

Note that all of the softkeys that have active functions have these numeric values blanked when this function is on. This is a security feature..

10 Monitor Spectrum Measurement  
View/Display

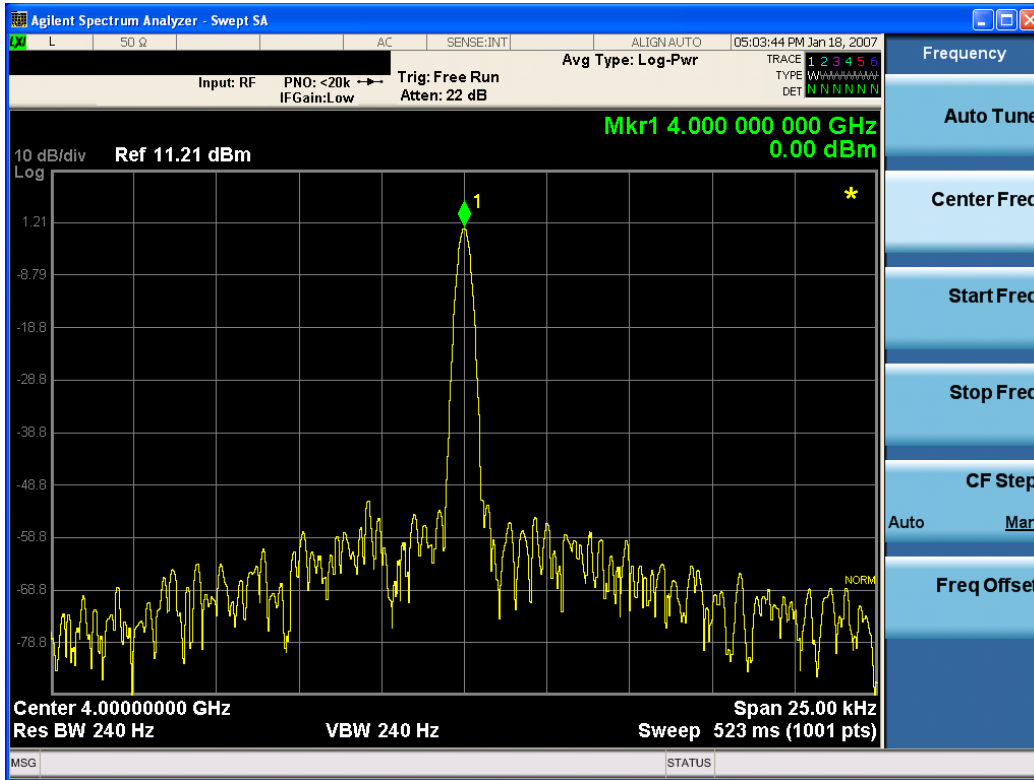

Key Path	View/Display, Display, Annotation
Remote Command	:DISPlay:ACTivefunc[:STATE] ON OFF 1 0 :DISPlay:ACTivefunc[:STATE]?
Example	DISP:ACT OFF
Dependencies	Grayed out and forced to OFF when System Display Settings, Annotation is set to Off.
Preset	On This should remain Off through a Preset when System DisplaySettings, Annotation is set to Off
State Saved	Saved in instrument state.
Initial S/W Revision	Prior to A.02.00

Title

Displays menu keys that enable you to change or clear a title on your display.

Key Path	View/Display, Display
Initial S/W Revision	Prior to A.02.00

Change Title

Writes a title into the "measurement name" field in the banner, for example, "Swept SA".

Press Change Title to enter a new title through the alpha editor. Press Enter or Return to complete the entry. Press ESC to cancel the entry and preserve your existing title.

The display title will replace the measurement name. It remains for this measurement until you press Change Title again, or you recall a state, or a Preset is performed. A title can also be cleared by pressing Title, Clear Title.

**NOTE**

Notice the inclusion of the <measurement> parameter in the command below. Because each measurement remembers the Display Title, the command must be qualified with the measurement name. For the Swept SA measurement this is not the case; no <measurement> parameter is used when changing the Display Title for the Swept SA measurement.

Key Path	View/Display, Display, Title
Mode	All
<b>Remote Command</b>	:DISPlay:<measurement>:ANNotation:TITLe:DATA <string> :DISPlay:<measurement>:ANNotation:TITLe:DATA?
<b>Example</b>	DISP:ANN:TITL:DATA "This Is My Title" This example is for the Swept SA measurement in the Spectrum Analyzer mode. The SANalyzer <measurement> name is not used. DISP:ACP:ANN:TITL:DATA "This Is My Title" This example is for Measurements other than Swept SA. Both set the title to: This Is My Title
Notes	Pressing this key cancels any active function. When a title is edited the previous title remains intact (it is not cleared) and the cursor goes at the end so that characters can be added or BKSP can be used to go back over previous characters.
Preset	No title (measurement name instead)
State Saved	Saved in instrument state.
Initial S/W Revision	Prior to A.02.00

### Clear Title

Clears a title from the front-panel display. Once cleared, the title cannot be retrieved. After the title is cleared, the current Measurement Name replaces it in the title bar.

Key Path	View/Display, Display, Title
<b>Example</b>	The following commands clear the title and restore the measurement's original title: DISP:ANN:TITL:DATA "" This example is for the Swept SA measurement in the Spectrum Analyzer mode. The SANalyzer <measurement> name is not used. DISP:ACP:ANN:TITL:DATA "" This example is for ACP; in measurements other than Swept SA the measurement name is required.
Notes	Uses the :DISPlay:<measurement>:ANNotation:TITLe:DATA <string> command with an empty string (in the Swept SA, the <measurement> is omitted).
Preset	Performed on Preset.
Initial S/W Revision	Prior to A.02.00

## Graticule

Pressing Graticule turns the display graticule On or Off. It also turns the graticule y-axis annotation on and off.

Key Path	View/Display, Display
Remote Command	:DISPlay:WINDow[1]:TRACe:GRATicule:GRID[:STATe] OFF ON 0 1 :DISPlay:WINDow[1]:TRACe:GRATicule:GRID[:STATe]?
Example	DISP:WIND:TRAC:GRAT:GRID OFF
Notes	The graticule is the set of horizontal and vertical lines that make up the grid/divisions for the x-axis and y-axis.
Preset	On
State Saved	Saved in instrument state
Initial S/W Revision	Prior to A.02.00

## System Display Settings

These settings are "Mode Global" – they affect all modes and measurements and are reset only by Restore Misc Defaults or Restore System Defaults under System.

Key Path	View/Display, Display
Initial S/W Revision	Prior to A.02.00

## Annotation Local Settings

This is a Mode Global override of the meas local annotation settings. When it is All Off, it forces ScreenAnnotation, Meas Bar, Trace, and Active Function Values settings to be OFF for all measurements in all modes. This provides the security based "annotation off" function of previous analyzers; hence it uses the legacy SCPI command.

When it is All Off, the Screen, Meas Bar, Trace, and Active Function Values keys under the Display, Annotation menu are grayed out and forced to Off. When Local Settings is selected, you are able to set the local annotation settings on a measurement by measurement basis.

Key Path	View/Display, Display, System Display Settings
Remote Command	:DISPlay:WINDow[1]:ANNotation[:ALL] OFF ON 0 1 :DISPlay:WINDow[1]:ANNotation[:ALL]?
Example	:DISP:WIND:ANN OFF
Preset	On (Set by Restore Misc Defaults)
State Saved	Not saved in instrument state.
Backwards Compatibility Notes	The WINDow parameter and optional subopcode is included for backwards compatibility but ignored – all windows are equally affected.
Initial S/W Revision	Prior to A.02.00

## Themes

Accesses a menu of functions that enable you to choose the theme to be used when saving the screen image.

The **Themes** option is the same as the **Themes** option under the **Display** and **Page Setup** dialogs. It allows you to choose between themes to be used when saving the screen image.

<b>Key Path</b>	Save, Screen Image
<b>Remote Command</b>	:MMEMory:STORe:SCReen:THEMe TDColor   TDMonochrome   FCOLor   FMONochrome  :MMEMory:STORe:SCReen:THEMe?
<b>Example</b>	:MMEM:STOR:SCR:THEM TDM
<b>Preset</b>	3D Color; Is not part of Preset, but is reset by Restore Misc Defaults or Restore System Defaults All and survives subsequent running of the modes.
<b>Readback</b>	3D Color   3D Mono   Flat Color   Flat Mono
<b>Backwards Compatibility Notes</b>	In ESA and PSA we offer the choice of "Reverse Bitmap" or "Reverse Metafile" when saving screen images. This is much like the "Flat Color" theme available in X-Series. Also, if you selected Reverse Bitmap AND a black & white screen image, that would be much like "Flat Monochrome". In other words, each of the X-Series themes has a similar screen image type in ESA/PSA. But they are not identical.
<b>Initial S/W Revision</b>	Prior to A.02.00

### 3D Color

Selects a standard color theme with each object filled, shaded and colored as designed.

<b>Key Path</b>	Save, Screen Image, Themes
<b>Example</b>	MMEM:STOR:SCR:THEM TDC
<b>Readback</b>	3D Color
<b>Initial S/W Revision</b>	Prior to A.02.00

### 3D Monochrome

Selects a format that is like 3D color but shades of gray are used instead of colors.

<b>Key Path</b>	Save, Screen Image, Themes
<b>Example</b>	MMEM:STOR:SCR:THEM TDM
<b>Readback</b>	3D Mono
<b>Initial S/W Revision</b>	Prior to A.02.00

### Flat Color

Selects a format that is best when the screen is to be printed on an ink printer.

Key Path	Save, Screen Image, Themes
<b>Example</b>	MMEM:STOR:SCR:THEM FCOL
Readback	Flat Color
Initial S/W Revision	Prior to A.02.00

### Flat Monochrome

Selects a format that is like Flat Color. But only black is used (no colors, not even gray), and no fill.

Key Path	Save, Screen Image, Themes
<b>Example</b>	MMEM:STOR:SCR:THEM FMON
Readback	Flat Mono
Initial S/W Revision	Prior to A.02.00

### Backlight

Accesses the display backlight on/off keys. This setting may interact with settings under the Windows "Power" menu.

When the backlight is off, pressing ESC, TAB, SPACE, ENTER, UP, DOWN, LEFT, RIGHT, DEL, BKSP, CTRL, or ALT turns the backlight on without affecting the application. Pressing any other key will turn backlight on and could potentially perform the action as well.

Key Path	View/Display, Display, System Display Settings
<b>Remote Command</b>	:DISPlay:BACKlight ON OFF :DISPlay:BACKlight?
Preset	ON (Set by Restore Misc Defaults)
Initial S/W Revision	Prior to A.02.00

### Backlight Intensity

An active function used to set the backlight intensity. It goes from 0 to 100 where 100 is full on and 0 is off. This value is independent of the values set under the Backlight on/off key.

Key Path	View/Display, Display, System Display Settings
<b>Remote Command</b>	:DISPlay:BACKlight:INTensity <integer> :DISPlay:BACKlight:INTensity?
<b>Example</b>	DISP:BACK:INT 50

Preset	100 (Set by Restore Misc Defaults)
Min	0
Max	100
Initial S/W Revision	Prior to A.02.00

## Expand Meters

Monitor Spectrum displays the Spectrum on the left and the Meters on the right. When Expand Meters is off, the normal view is presented. When Expand Meters is on, the meters display is expanded and large characters are used, for easy viewing at a distance.

See ["Example Views" on page 888](#)

Key Path	View Dsplay
<b>Remote Command</b>	:DISPlay:MONitor:VIEW:EXPand:METer[:STATE] ON OFF 1 0 :DISPlay:MONitor:VIEW:EXPand:METer[:STATE]?
<b>Example</b>	DISP:MON:VIEW:EXP:MET OFF DISP:MON:VIEW:EXP:MET?
Preset	OFF
State Saved	Saved in instrument state
Initial S/W Revision	A.13.00

## Freq Scan Graph

Monitor Spectrum can display the trace and graticule from the Freq Scan display. All settings of the Freq Scan display including the X-axis settings are the same as in the Freq Scan measurement (you must go to the Freq Scan measurement to change them).

Key Path	View Dsplay
<b>Remote Command</b>	:DISPlay:MONitor:VIEW:FSCan[:STATE] ON OFF 1 0 :DISPlay:MONitor:VIEW:FSCan[:STATE]?
<b>Example</b>	DISP:MON:VIEW:FSC OFF DISP:MON:VIEW:FSC?
Preset	OFF
State Saved	Saved in instrument state
Initial S/W Revision	A.14.00

### Meters RBW Lines

When Meters RBW Lines is turned on, two blue vertical lines appear on the display, equal distances from the center of the graticule. Their spacing matches the current setting for the Meters RBW as shown below.

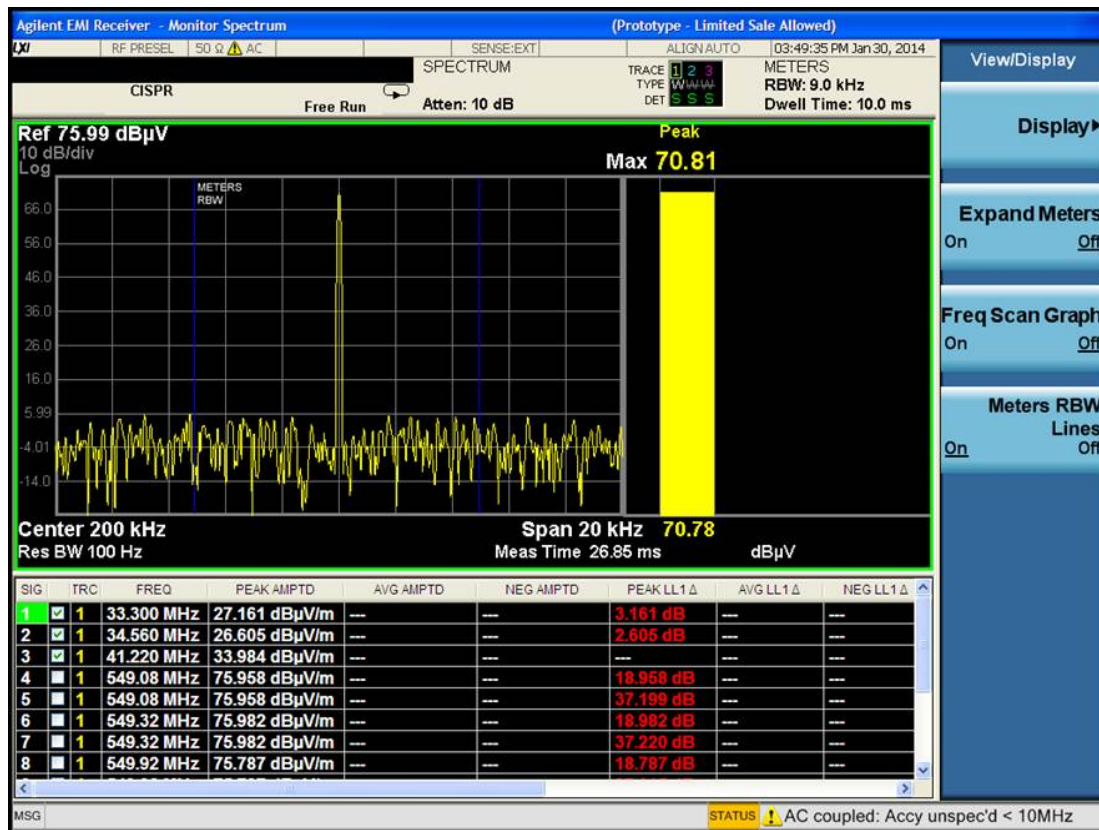

If the Meters RBW is wider than the span of the Monitor Spectrum display, these lines are not shown.

Key Path	View Display
Remote Command	:DISPlay:MONitor:RBWLines[:STATe] ON OFF 1 0 :DISPlay:MONitor:RBWLines[:STATe]?
Example	DISP:MON:RBWL ON DISP:MON:RBWL?
Preset	OFF
State Saved	Saved in instrument state
Initial S/W Revision	A.14.50

### Example Views

Below are the views with Expand Meters Off (top) and Expand Meters on (bottom)



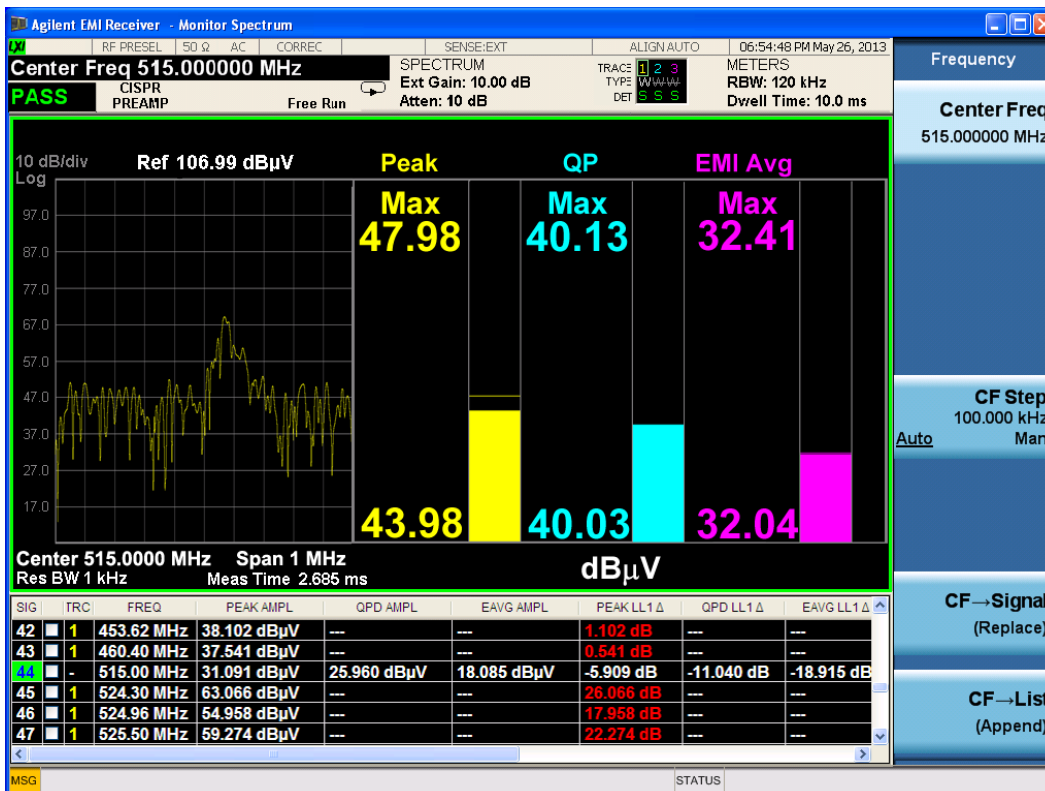
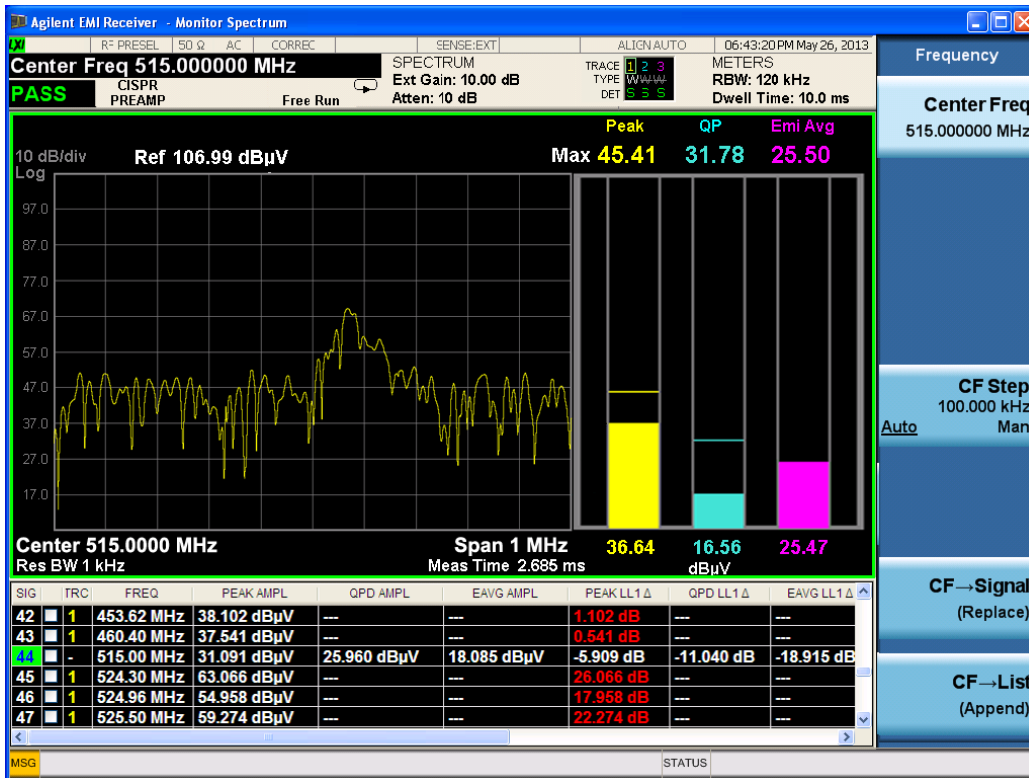

And here are the views with the top window zoomed, with and without expanded meters:

10 Monitor Spectrum Measurement View/Display

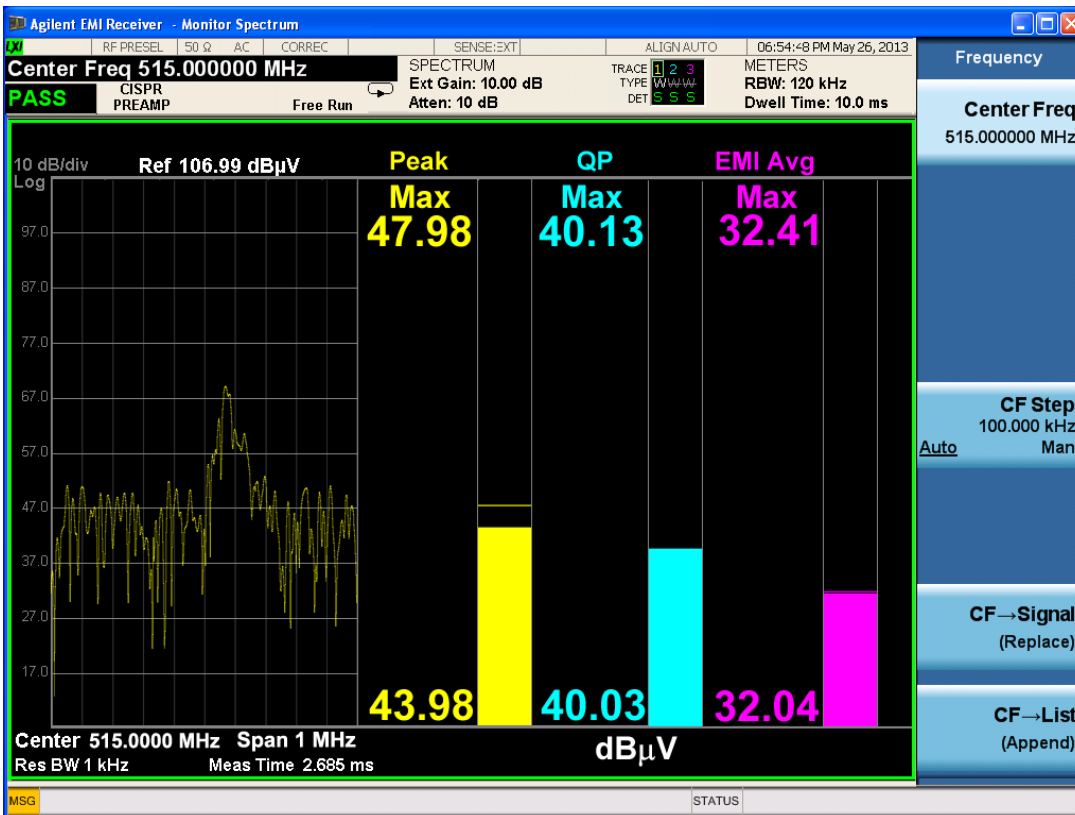
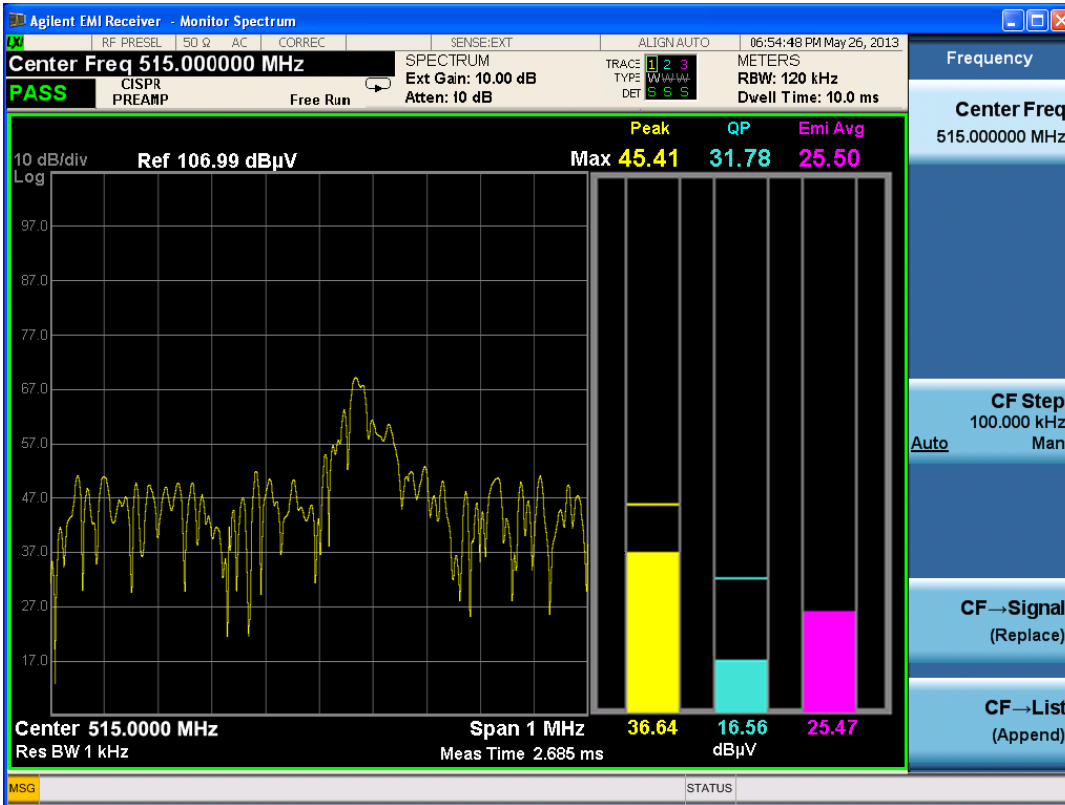

This window displays the trace and graticule from the Freq Scan display. Marker is available. The X axis can be Log or Lin depending on the setting in Frequency Scan measurement.

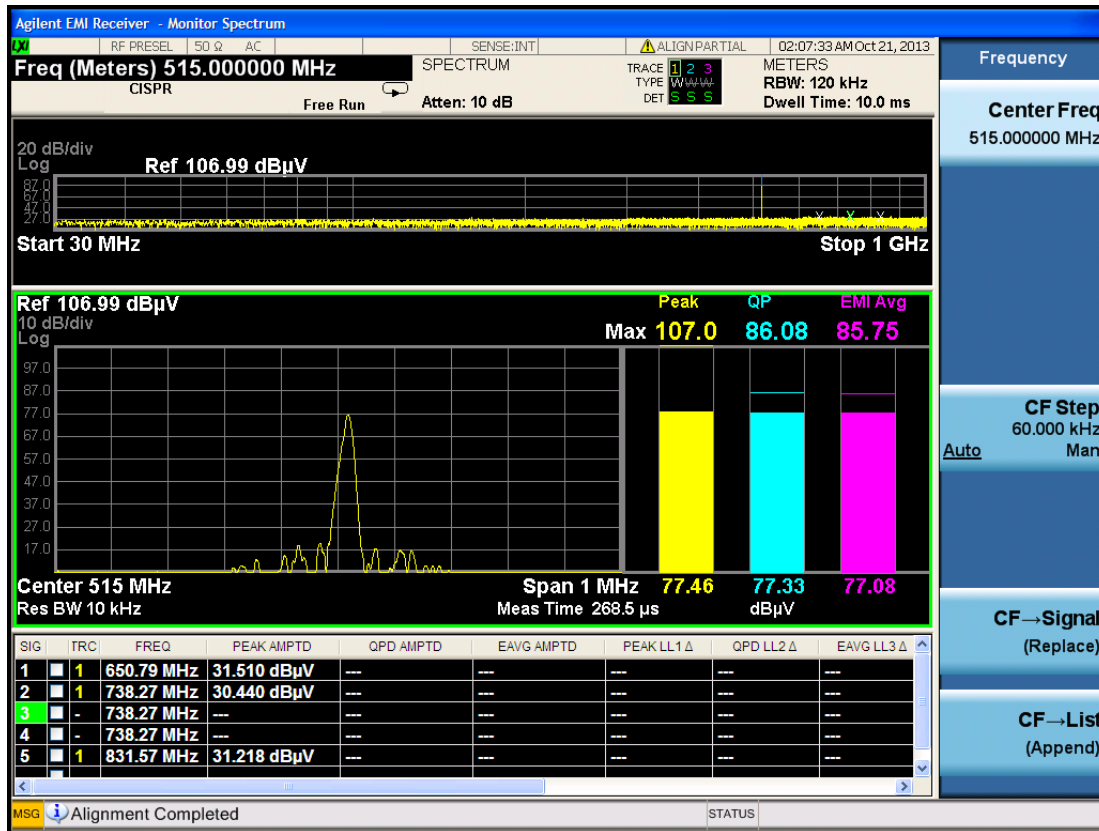



## 11 APD Measurement

The Amplitude Probability Distribution (APD) measurement shows power statistical data in graphical format and in a signal list.

### Measurement Commands for APD

CONFigure:APD

CONFigure:APD:NDEFault

CONFigure?

INITiate:APD

FETCh:APD[n]?

MEASure:APD[n]?

READ:APD[n]?

Topics in this section are:

["Remote Command Results for APD" on page 894](#)

["Measurement Description" on page 895](#)

## Remote Command Results for APD

Command	n	Return Value
INITiate:APD	n/a	n/a
CONFigure?	n/a	name of current measurement: "APD"
CONFigure:APD	n/a	n/a (selects the APD measurement in Meas Preset state)
CONFigure:APD:NDEFault	n/a	n/a (selects the APD measurement without affecting settings)
FEtCh:APD[n]? MEASure:APD[n]? READ:APD[n]?	not specified or n=1	Returns a comma separated list containing detailed information in the following format: <ul style="list-style-type: none"> <li>• Number of Peak Signal in the following list (integer)</li> </ul> [Repeat the following for each peak] <ul style="list-style-type: none"> <li>• Signal#</li> <li>• Trace# where peak is located</li> <li>• Frequency</li> <li>• Disturbance Level (E meas)</li> <li>• Probability of Time (p meas)</li> <li>• Disturbance Level to Limit Delta</li> <li>• Probability to Limit Delta</li> </ul>
	2	Returns a series of 1024 points Trace 1 data as a list of x,y pairs. x is the Probability of Time, while y is the disturbance level. The y-values are in the current X Axis Unit of the instrument. When querying trace data, it is best if the analyzer is not sweeping during the query. Therefore, it is good to be in Single Sweep, or Update=Off when querying trace data from the instrument.
	3	Returns a series of 1024 points Trace 2 data as a series of x,y pairs.
	4	Returns a series of 1024 points Trace 3 data as a series of x,y pairs.

## Measurement Description

Traditionally, EMI measurements have been performed by EMI receivers using defined RBW and detector modes like quasi-peak, peak and average. However, the advances in digital technology created a need for a measurement method to protect digital radio communication services. APD was introduced in Amendment 1:2005 to CISPR 16-1-1:2003 as a new weighting method to accurately determine the electromagnetic disturbance emitted by electrical appliances or equipment, which degrade the performance of digital communication system.

The APD of disturbance is defined as the cumulative distribution of the “probability of time that the amplitude of disturbance exceeds a specified level”.

---

Key Path	Meas
Initial S/W Revision	A.13.00

---

## AMPTD Y Scale

Displays the menu keys that enable you to control the amplitude parameters.

Key Path	Front-panel key
Notes	Front panel only.
Initial S/W Revision	A.13.00

### Attenuation

Enables you to set the value of the Attenuation parameter. This key only affects the Mechanical Attenuator in the EMI Receiver mode and has no Auto setting.

For the Frequency Scan measurement, this key only affects the attenuation used for meters.

The following amplitude parameters are not settable by the user and therefore do not appear in any menus:

Elec Attenuator	Disabled
Elec Attenuation	0dB
Meas Atten Step	2dB
Max Mixer Level	-10dBm

Key Path	AMPTD Y Scale
<b>Remote Command</b>	<code>[ :SENSe ] :POWer [ :RF ] :ATTenuation &lt;rel_ampl&gt;</code> <code>[ :SENSe ] :POWer [ :RF ] :ATTenuation?</code>
<b>Example</b>	POW:ATT 10 POW:ATT?
Preset	10 dB
State Saved	Saved in instrument state.
Min	0 dB
Max	50 dB (CXA) 60 dB (EXA) 70 dB (MXA, PXA& N9038A)
Default Unit	dB
<b>Backwards Compatibility SCPI</b>	<code>:INPut [1]   2 :ATTenuation</code>
Backwards Compatibility SCPI Notes	This command above is included for ESU compatibility. The suffix [1] 2 is irrelevant to the measurement, they are added solely for remote language compatibility. This SCPI is Meas Local and Context Sensitive.
Initial S/W Revision	A.07.00



## Autorange

Accesses a menu that enables you to choose whether or not to turn on the Autorange feature.

Key Path	Amptd Y Scale
Readback	In square brackets, the state of Autorange then the state of Auto Preamp, separated by commas, as [Rng:On, Pre:Off]
Initial S/W Revision	A.13.00

## Autorange

When autorange is selected, the attenuation will be increased automatically when an overload is detected.

Key Path	Amptd Y Scale, Autorange
<b>Remote Command</b>	[ :SENSe ] :APD:ATTenuation:AUTO ON OFF 1 0 [ :SENSe ] :APD:ATTenuation:AUTO?
<b>Example</b>	:APD:ATT:AUTO 0 :APD:ATT:AUTO?
Preset	OFF
State Saved	Saved in instrument state
Initial S/W Revision	A.13.00

## Auto Preamp

When ON, Internal Preamp will be considered in the autorange procedure.

Key Path	Amptd Y Scale, Autorange
<b>Remote Command</b>	[ :SENSe ] :APD:GAIN:AUTO ON OFF 1 0 [ :SENSe ] :APD:GAIN:AUTO?
<b>Example</b>	:APD:GAIN:AUTO ON :APD:GAIN:AUTO?
Preset	OFF
State Saved	Saved in instrument state
Initial S/W Revision	A.13.00

## Presel Center

When this key is pressed, the centering of the preselector filter is adjusted to optimize the amplitude accuracy at the frequency of the selected marker. If the selected marker is not on when Presel Center is

pressed, the analyzer will turn on the selected marker, perform a peak search, and then perform centering on the marker's center frequency. If the selected marker is already on and between the start and stop frequencies of the analyzer, the analyzer performs the preselector calibration on that marker's frequency. If the selected marker is already on, but outside the frequency range between Start Freq and Stop Freq, the analyzer will first perform a peak search, and then perform centering on the marker's center frequency.

The value displayed on the Presel Adjust key will change to reflect the new preselector tuning (see Presel Adjust).

A number of considerations should be observed to ensure proper operation. See ["Proper Preselector Operation" on page 898](#).

<b>Key Path</b>	AMPTD Y Scale
<b>Remote Command</b>	<code>[ :SENSe ] :POWer [ :RF ] :PCENter</code>
<b>Example</b>	POW:PCEN
<b>Notes</b>	Note that the rules outlined above under the key description apply for the remote command as well as the key. The result of the command is dependent on marker position, and so forth. Any message shown by the key press is also shown in response to the remote command.
<b>Dependencies</b>	<ul style="list-style-type: none"> <li>• Grayed out if the microwave preselector is off. )</li> <li>• If the selected marker's frequency is below Band 1, advisory message 0.5001 is generated and no action is taken.</li> <li>• Grayed out if entirely in Band 0.</li> <li>• Blank in models that do not include a preselector, such as option 503. If the SCPI is sent in these instruments, it is accepted without error, and the query always returns 0.</li> <li>• Grayed out in the Spectrogram View.</li> </ul>
<b>Couplings</b>	<p>The active marker position determines where the centering will be attempted.</p> <p>If the analyzer is in a measurement such as averaging when centering is initiated, the act of centering the preselector will restart averaging but the first average trace will not be taken until the centering is completed.</p>
<b>Status Bits/OPC dependencies</b>	<p>When centering the preselector, *OPC will not return true until the process is complete and a subsequent measurement has completed, nor will results be returned to a READ or MEASure command.</p> <p>The Measuring bit should remain set while this command is operating and should not go false until the subsequent sweep/measurement has completed.</p>
<b>Initial S/W Revision</b>	Prior to A.02.00
<b>Modified at S/W Revision</b>	A.03.00

## Proper Preselector Operation

A number of considerations should be observed to ensure proper operation:

1. If the selected marker is off, the analyzer will turn on a marker, perform a peak search, and adjust the preselector using the selected marker's frequency. It uses the "highest peak" peak search method unqualified by threshold or excursion, so that there is no chance of a 'no peak found' error. It continues

with that peak, even if it is the peak of just noise. Therefore, for this operation to work properly, there should be a signal on screen in a preselected range for the peak search to find.

2. If the selected marker is already on, the analyzer will attempt the centering at that marker's frequency. There is no preselector for signals below about 3.6 GHz, therefore if the marker is on a signal below 3.6 GHz, no centering will be attempted and an advisory message generated
3. In some models, the preselector can be bypassed. If it is bypassed, no centering will be attempted in that range and a message will be generated.

## Preselector Adjust

Allows you to manually adjust the preselector filter frequency to optimize its response to the signal of interest. This function is only available when "Presel Center" on page 897 is available.

For general purpose signal analysis, using Presel Center is recommended. Centering the filter minimizes the impact of long-term preselector drift. Presel Adjust can be used instead to manually optimize the preselector. One application of manual optimization would be to peak the preselector response, which both optimizes the signal-to-noise ratio and minimizes amplitude variations due to small (short-term) preselector drifting.

Key Path	AMPTD Y Scale
Scope	Meas Global
Remote Command	<code>[ :SENSe ] :POWer [ :RF ] :PADJust &lt;freq&gt;</code> <code>[ :SENSe ] :POWer [ :RF ] :PADJust?</code>
Example	<code>POW:PADJ 100KHz</code> <code>POW:PADJ?</code>
Notes	The value on the key reads out to 0.1 MHz resolution.
Dependencies	<ul style="list-style-type: none"> <li>• Grayed out if microwave preselector is off. )</li> <li>• Grayed out if entirely in Band 0.</li> <li>• Blank in models that do not include a preselector, such as option 503. If the SCPI is sent in these instruments, it is accepted without error, and the query always returns 0.</li> <li>• Grayed out in the Spectrogram View.</li> </ul>
Preset	0 MHz
State Saved	The Presel Adjust value set by Presel Center, or by manually adjusting Presel Adjust, is not saved in instrument state, and does not survive a Preset or power cycle.
Min	-500 MHz
Max	500 MHz
Default Unit	Hz
Backwards Compatibility SCPI	<code>[ :SENSe ] :POWer [ :RF ] :MW :PADJust</code> <code>[ :SENSe ] :POWer [ :RF ] :MMW :PADJust</code> PSA had multiple preselectors, but the X-Series has only one. These commands simply alias to <code>[ :SENSe ] :POWer [ :RF ] :PADJust</code>

Initial S/W Revision	Prior to A.02.00
Modified at S/W Revision	A.03.00

<b>Remote Command</b>	<code>[[:SENSe]:POWer[:RF]:PADJust:PRESelector MWAVE   MMWave   EXTernal [:SENSe]:POWer[:RF]:PADJust:PRESelector?</code>
Notes	PSA had multiple preselectors, and you could select which preselector to adjust. Since the X-Series has only one mm/uW preselector, the preselector selection softkey is no longer available. However, to provide backward compatibility, we accept the legacy remote commands. The command form has no effect, the query always returns MWAVE

Initial S/W Revision	Prior to A.02.00
----------------------	------------------

## Amplitude Unit

This displays the menu keys that enable you to change the amplitude unit for X Axis. For this measurement, the amplitude level falls on the X-axis of the display.

Key Path	Amptd Y Scale
<b>Remote Command</b>	<code>:UNIT:APD:POWer DBM DBMV DBMA W V A DBUV DBUA DBPW DBUVM DBUAM DBPT DBG :UNIT:APD:POWer?</code>
<b>Example</b>	UNIT:APD:POW DBUV UNIT:APD:POW?
Dependencies	If an amplitude correction with an Antenna Unit other than None is applied and enabled, and you then turn off that correction or set Apply Corrections to No, the Amplitude Unit that existed before the Antenna Unit was applied is restored.
Couplings	In the EMI Receiver application, this parameter is coupled to the X Axis unit of other measurements.
Preset	DBUV
State Saved	Saved in instrument state
Range	DBM DBMV DBMA W V A DBUV DBUA DBPW DBUVM DBUAM DBPT DBG
Readback Text	The currently selected Amplitude Unit
Initial S/W Revision	A.13.00

<b>Remote Command</b>	<code>:UNIT[1] 2:POWer DBUV   DBUV_MHZ   DBM   DBUA   DBUA_MHZ   DBPW   DBPW_MHZ   DBPT   DBPT_MHZ   DBMV   DBMV_MHZ :UNIT[1] 2:POWer?</code>
Notes	This command is included for ESU compatibility. The suffix [1]2 is irrelevant to the measurement, they are added solely for the compatibility purpose

---

The following SCPI will return a -224, "Illegal parameter value".

UNIT:POW DBUV\_MHZ

UNIT:POW DBUA\_MHZ

UNIT:POW DBPW\_MHZ

UNIT:POW DBPT\_MHZ

UNIT:POW DBMV\_MHZ

---

**Backwards Compatibility SCPI** :CALCulate[1]|2:UNIT:POWer

---

**Backwards Compatibility SCPI Notes** ESU supports both :CALCulate[1]2:UNIT:POWer and UNIT[1]2.  
 Note that the suffix [1]2 is irrelevant to the measurement, they are added solely for the compatibility purpose  
 CALC:UNIT:POW DBUV is an alias to UNIT:POW DBUV  
 CALC:UNIT:POW DBM is an alias to UNIT:POW DBM  
 CALC:UNIT:POW DBUA is an alias to UNIT:POW DBUA  
 CALC:UNIT:POW DBPT is an alias to UNIT:POW DBPT  
 CALC:UNIT:POW DBMV is an alias to UNIT:POW DBM  
 CALC:UNIT:POW DBPW is an alias to UNIT:POW DBPW

---

## dBm

This sets the amplitude unit for the selected amplitude scale to dBm.

---

Key Path	AMPTD Y Scale, Amplitude Unit
<b>Example</b>	UNIT:APD:POW DBM
Dependencies	Grayed out if an Amplitude Correction with an Antenna Unit is ON.
Readback	dBm
Initial S/W Revision	A.13.00

---

## dBmV

This sets the amplitude unit for the selected amplitude scale to dBmV.

---

Key Path	AMPTD Y Scale, Amplitude Unit
<b>Example</b>	UNIT:APD:POW DBMV
Dependencies	Grayed out if an Amplitude Correction with an Antenna Unit is ON.
Readback	dBmV
Initial S/W Revision	A.13.00

---

## dBmA

This sets the amplitude unit for the selected amplitude scale to dBmA.

Key Path	AMPTD Y Scale, Amplitude Unit
<b>Example</b>	UNIT:APD:POW DBMA
Dependencies	Grayed out if an Amplitude Correction with an Antenna Unit is ON.
Readback	dBmA
Initial S/W Revision	A.13.00

## W

This sets the amplitude unit for the selected amplitude scale to watts.

Key Path	AMPTD Y Scale, Amplitude Unit
<b>Example</b>	UNIT:APD:POW W
Dependencies	Grayed out if an Amplitude Correction with an Antenna Unit is ON.
Readback	W
Initial S/W Revision	A.13.00

## V

This sets the amplitude unit for the selected amplitude scale to volts.

Key Path	AMPTD Y Scale, Amplitude Unit
<b>Example</b>	UNIT:APD:POW V
Dependencies	Grayed out if an Amplitude Correction with an Antenna Unit is ON.
Readback	V
Initial S/W Revision	A.13.00

## A

This sets the amplitude unit for the selected amplitude scale to Amperes.

Key Path	AMPTD Y Scale, Amplitude Unit
<b>Example</b>	UNIT:APD:POW A
Dependencies	Grayed out if an Amplitude Correction with an Antenna Unit is ON.
Readback	A
Initial S/W Revision	A.13.00

## dB $\mu$ V

This sets the amplitude unit for the selected amplitude scale to dB $\mu$ V.

Key Path	AMPTD Y Scale, Amplitude Unit
<b>Example</b>	UNIT:APD:POW DBUV
Dependencies	Grayed out if an Amplitude Correction with an Antenna Unit is ON.
Readback	dB $\mu$ V
Initial S/W Revision	A.13.00

## dB $\mu$ A

This sets the amplitude unit for the selected amplitude scale to dB $\mu$ A.

Key Path	AMPTD Y Scale, Amplitude Unit
<b>Example</b>	UNIT:APD:POW DBUA
Dependencies	Grayed out if an Amplitude Correction with an Antenna Unit is ON.
Readback	dB $\mu$ A
Initial S/W Revision	A.13.00

## dBpW

This sets the amplitude unit for the selected amplitude scale to dBpW. This is an antenna unit, and this key is grayed out unless a correction with this Antenna Unit selected is ON. If this is the case, all of the other Antenna Units are grayed out.

Key Path	AMPTD Y Scale, Amplitude Unit
<b>Example</b>	UNIT:APD:POW DBPW
Dependencies	Grayed out if an Amplitude Correction with an Antenna Unit is ON.
Readback	dBpW
Initial S/W Revision	A.13.00

## Antenna Unit

When a Correction is turned on that uses an Antenna Unit, the Y Axis Unit changes to that Antenna Unit. All of the keys in the Y-Axis Unit menu are then greyed out, except the Antenna Unit key. The unit being used is shown on this key and is shown as selected in the submenu.

Key Path	AMPTD Y Scale, Amplitude Unit
Dependencies	Grayed out if no Amplitude Correction with an Antenna Unit is on.
Readback line	Currently selected unit
Initial S/W Revision	A.13.00

### dB $\mu$ V/m

This sets the amplitude unit for the selected amplitude scale to dB $\mu$ V/m. This is an antenna unit, and this key is grayed out unless a Correction with this Antenna Unit selected is ON. If this is the case, all of the other Antenna Units are grayed out.

Key Path	AMPTD Y Scale, Amplitude Unit, Antenna Unit
<b>Example</b>	UNIT:APD:POW DBUVM
Dependencies	Grayed out if no Amplitude Correction with an Antenna Unit is on.
Readback	dB $\mu$ V/m
Initial S/W Revision	A.13.00

### dB $\mu$ A/m

This sets the amplitude unit for the selected amplitude scale to dB $\mu$ A/m. This is an antenna unit, and this key is grayed out unless a Correction with this Antenna Unit selected is ON. If this is the case, all of the other Antenna Units are grayed out.

Key Path	AMPTD Y Scale, Amplitude Unit, Antenna Unit
<b>Example</b>	UNIT:APD:POW DBUAM
Dependencies	Grayed out if no Amplitude Correction with an Antenna Unit is on.
Readback	dB $\mu$ A/m
Initial S/W Revision	A.13.00

### dB $\mu$ A

This sets the amplitude unit for the selected amplitude scale to dB $\mu$ A. This is an antenna unit, and this key is grayed out unless a Correction with this Antenna Unit selected is ON. If this is the case, all of the other Antenna Units are grayed out.

Key Path	AMPTD Y Scale, Amplitude Unit, Antenna Unit
<b>Example</b>	UNIT:POW DBUAM
Dependencies	Grayed out if no Amplitude Correction with an Antenna Unit is on.
Readback	dB $\mu$ A
Initial S/W Revision	A.13.00

### dBpT

This sets the amplitude unit for the selected amplitude scale to dBpT. This is an antenna unit, and this key is grayed out unless a Correction with this Antenna Unit selected is ON. If this is the case, all of the other Antenna Units are grayed out.



Key Path	AMPTD Y Scale, Amplitude Unit, Antenna Unit
<b>Example</b>	UNIT:APD:POW DBPT
Dependencies	Grayed out if no Amplitude Correction with an Antenna Unit is on.
Readback	dBpT
Initial S/W Revision	A.13.00

## dBG

This sets the amplitude unit for the selected amplitude scale to dBG. This is an antenna unit, and this key is grayed out unless a Correction with this Antenna Unit selected is ON. If this is the case, all of the other Antenna Units are grayed out.

Key Path	AMPTD Y Scale, Amplitude Unit, Antenna Unit
<b>Example</b>	UNIT:APD:POW DBG
Dependencies	Grayed out if no Amplitude Correction with an Antenna Unit is on.
Readback	dBG
Initial S/W Revision	A.13.00

## None

This is selected if no Antenna Unit is currently on, however you cannot actually set this value, since it is always grayed out. The key is included simply to provide an indication on the Readback line of the Antenna Unit key when there is no Antenna Unit selected.

Key Path	AMPTD Y Scale, Amplitude Unit, Antenna Unit
Readback	"None"
Initial S/W Revision	A.13.00

## Internal Preamp

Accesses a menu of keys that control the internal preamps. Turning on the preamp gives a better noise figure, but a poorer TOI to noise floor dynamic range. You can optimize this setting for your particular measurement.

The instrument takes the preamp gain into account as it sweeps. If you sweep outside of the range of the preamp the instrument will also account for that. The displayed result will always reflect the correct gain.

For some measurements, when the preamp is on and any part of the displayed frequency range is below the lowest frequency for which the preamp has specifications, a warning condition message appears in the status line. For example, for a preamp with a 9 kHz lowest specified frequency: "Preamp: Accy unspec'd below 9 kHz".

Key Path	AMPTD Y Scale
Scope	Meas Global
Remote Command	[ :SENSe] :POWer [ :RF] :GAIN [ :STATe] OFF   ON   0   1 [ :SENSe] :POWer [ :RF] :GAIN [ :STATe] ?
Dependencies	Preamp is not available on all hardware platforms. If the preamp is not present or is unlicensed, the key is not shown. The preamp is not available when the electronic/soft attenuator is enabled.
Couplings	The act of connecting the U7227A USB Preamplifier to one of the analyzer's USB ports will cause the Internal Preamp to be switched on. When this happens an informational message will be generated: "Internal Preamp turned on for optimal operation with USB Preamp." Note that if the Internal Preamp was already on, there will be no change to the setting, but if it was Off it will be switched On, to Full Range. Note that this same action occurs when the SA mode is selected while the USB Preamp is connected to one of the analyzer's USB ports, if it is the first time that the SA mode has run since powerup, or if the last time the SA mode was running the USB Preamp was NOT connected. Subsequently disconnecting the USB Preamp from USB does not change the Internal Preamp setting nor restore the previous setting.
Preset	OFF
State Saved	Saved in instrument state
Initial S/W Revision	Prior to A.02.00
Modified at S/W Revision	A.14.00

Key Path	AMPTD Y Scale, Internal Preamp
Scope	Meas Global
Remote Command	[ :SENSe] :POWer [ :RF] :GAIN :BAND LOW   FULL [ :SENSe] :POWer [ :RF] :GAIN :BAND ?
Dependencies	Preamp is not available on all hardware platforms. If the preamp is not present or is unlicensed, the key is not shown. If a POW:GAIN:BAND FULL command is sent when a low band preamp is available, the preamp band parameter is to LOW instead of FULL, and an "Option not installed" message is generated.
Preset	LOW
State Saved	Saved in instrument state
Initial S/W Revision	Prior to A.02.00

## Off

Turns the internal preamp off

Key Path	AMPTD Y Scale, Internal Preamp
<b>Example</b>	:POW:GAIN OFF
Readback	Off
Initial S/W Revision	Prior to A.02.00

## Low Band

Sets the internal preamp to use only the low band.

The frequency range of the installed (optional) low-band preamp is displayed in square brackets on the Low Band key label.

Key Path	AMPTD Y Scale, Internal Preamp
<b>Example</b>	:POW:GAIN ON :POW:GAIN:BAND LOW
Readback	Low Band
Initial S/W Revision	Prior to A.02.00

## Full Range

Sets the internal preamp to use its full range. The low band (0–3.6 GHz or 0–3GHz, depending on the model) is supplied by the low band preamp and the frequencies above low band are supplied by the high band preamp.

The frequency range of the installed (optional) preamp is displayed in square brackets on the Full Range key label. If the high band option is not installed the Full Range key does not appear.

Key Path	AMPTD Y Scale, Internal Preamp
<b>Example</b>	:POW:GAIN ON :POW:GAIN:BAND FULL
Readback	Full Range
Initial S/W Revision	Prior to A.02.00

## μW Presel Center

Presel Center@3017.

## μW Presel Adjust

Preselector Adjust@3020.

## Auto Couple

The Auto Couple feature provides a quick and convenient way to automatically couple multiple instrument settings. This helps ensure accurate measurements and optimum dynamic range. When the Auto Couple feature is activated, either from the front panel or remotely, all parameters of the current measurement that have an Auto/Manual mode are set to Auto mode and all measurement settings dependent on (or coupled to) the Auto/Man parameters are automatically adjusted for optimal performance.

However, the Auto Couple key actions are confined to the current measurement only. It does not affect other measurements in the mode, and it does not affect markers, marker functions, or trace or display attributes.

See ["More Information" on page 908](#)

Key Path	Front-panel key
Remote Command	:COUPLe ALL NONE
Example	:COUP ALL
Notes	:COUPLe ALL puts all Auto/Man parameters in Auto mode (equivalent to pressing the Auto Couple key). :COUPLE NONE puts all Auto/Man parameters in manual mode. It decouples all the coupled instrument parameters and is not recommended for making measurements.
Initial S/W Revision	Prior to A.02.00

### More Information

There are two types of functions that have Auto/Manual modes.

#### Auto/Man Active Function keys

An Auto/Man toggle key controls the binary state associated with an instrument parameter by toggling between Auto (where the parameter is automatically coupled to the other parameters it is dependent upon) and Man (where the parameter is controlled independent of the other parameters), as well as making the parameter the active function. The current mode is indicated on the softkey with either Auto or Man underlined as illustrated below.



#### Auto/Man 1-of-N keys

An Auto/Man 1-of-N key allows you to manually pick from a list of parameter values, or place the function in Auto, in which case the value is automatically selected (and indicated) as shown below. If in Auto, Auto is underlined on the calling key. If in manual operation, manual is indicated on the calling key. But the calling key does not actually toggle the function, it simply opens the menu.

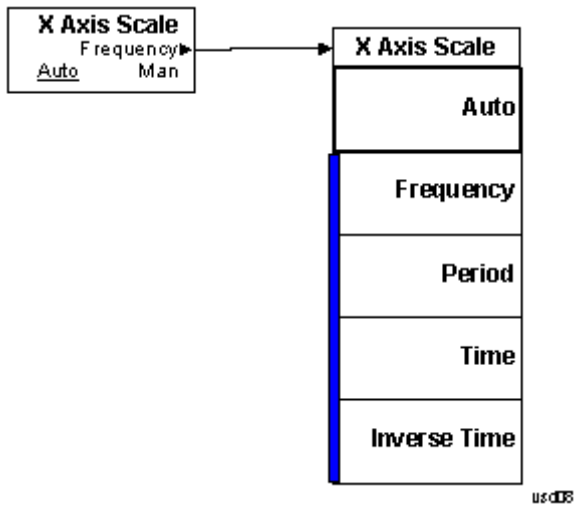

## BW

Displays the menu key that enables you to control the resolution BW.

Key Path	Front-panel key
Notes	Front panel only.
Initial S/W Revision	A.07.00

## Res BW

Activates the Resolution Bandwidth (RBW) action function, which allows you to manually set the RBW.

Key Path	BW								
<b>Remote Command</b>	<pre>[ :SENSe]:BANDwidth BWIDth[:RESolution] &lt;freq&gt; [:SENSe]:BANDwidth BWIDth[:RESolution]? [:SENSe]:BANDwidth BWIDth[:RESolution]:AUTO OFF ON 0 1 [:SENSe]:BANDwidth BWIDth[:RESolution]:AUTO?</pre>								
<b>Example</b>	<pre>BAND 200kHz BAND? FSC:BAND:AUTO 0 FSC:BAND:AUTO?</pre>								
Notes	<p>For Frequency Scan measurements, this key only affects RBWs used for meters.</p> <p>For numeric entries, the RBW chooses the nearest (arithmetically, on a linear scale, rounding up) available RBW to the value entered.</p> <p>The suffix 1 2 is irrelevant to the measurement, they are added solely for remote language compatibility.</p>								
Dependencies	<p>When in zero span and EMC Std is set to None, there is no Auto setting for the Res BW. The Auto/Man line on the Res BW softkey disappears in this case, and if the SCPI command [:SENSe]:BWID[:RESolution]:AUTO ON is sent, it generates an error.</p>								
Couplings	<p>When a CISPR or MIL EMI Standard is in use, the Res BW is coupled to the Center Frequency and not to the Span.</p> <p>When in the CISPR or MIL EMC Standard, selecting Auto will make RBW auto coupled to Center Frequency, in order to comply with EMI specs.</p> <p>When EMC Standard= CISPR,</p> <table border="1" style="width: 100%; border-collapse: collapse;"> <tr> <td style="width: 50%;"><math>&lt;150\text{ kHz}</math></td> <td style="width: 50%; text-align: right;">200 Hz</td> </tr> <tr> <td><math>150\text{ kHz to } &lt;30\text{ MHz}</math></td> <td style="text-align: right;">9 kHz</td> </tr> <tr> <td><math>\geq 30\text{ MHz to } &lt;1\text{ GHz}</math></td> <td style="text-align: right;">120 kHz</td> </tr> <tr> <td><math>\geq 1\text{ GHz}</math></td> <td style="text-align: right;">1 MHz</td> </tr> </table> <p>When EMC Standard= MIL,</p>	$<150\text{ kHz}$	200 Hz	$150\text{ kHz to } <30\text{ MHz}$	9 kHz	$\geq 30\text{ MHz to } <1\text{ GHz}$	120 kHz	$\geq 1\text{ GHz}$	1 MHz
$<150\text{ kHz}$	200 Hz								
$150\text{ kHz to } <30\text{ MHz}$	9 kHz								
$\geq 30\text{ MHz to } <1\text{ GHz}$	120 kHz								
$\geq 1\text{ GHz}$	1 MHz								

	< 1 kHz	10 Hz
	1 kHz to < 10 kHz	100 Hz
	10 kHz to < 150 kHz	1 kHz
	150 kHz to <30 MHz	10 kHz
	30 MHz to <1 GHz	100 kHz
	≥1 GHz	1 MHz
Preset	120 kHz ON	
State Saved	Saved in instrument state	
Min	1 Hz	
Max	8 MHz is the max equivalent -3 dB RBW, which means that the named RBW (the one shown on the key ) can actually exceed 8 MHz if using a filter type other than -3dB.	
Default Unit	Hz	
<b>Backwards Compatibility SCPI</b>	:SENSe1 SENSe2 [SENSe]:BANDwidth BWIDth[:RESolution]	
Backwards Compatibility SCPI Notes	This command above is included for ESU compatibility. The suffix 1 2 is irrelevant to the measurement, they are added solely for remote language compatibility.	
Initial S/W Revision	A.07.00	

## Cont (Continuous Measurement/Sweep)

Sets the analyzer for Continuous measurement operation. The single/continuous state is Meas Global so the setting will affect all measurements. If you are Paused, pressing Cont does a Resume.

<b>Key Path</b>	Front-panel key
<b>Remote Command</b>	:INITiate:CONTinuous OFF ON 0 1 :INITiate:CONTinuous?
<b>Example</b>	:INIT:CONT 0 puts analyzer in Single measurement operation. :INIT:CONT 1 puts analyzer in Continuous measurement operation
<b>Preset</b>	ON (Note that SYST:PRESet sets INIT:CONT to ON but *RST sets INIT:CONT to OFF)
<b>State Saved</b>	Saved in instrument state
<b>Backwards Compatibility Notes</b>	For Spectrum Analysis mode in ESA and PSA, there is no Cont hardkey, instead there is a Sweep Single/Cont key. In these analyzers, switching the Sweep Single/Cont key from Single to Cont restarts averages (displayed average count reset to 1), but does not restart Max Hold and Min Hold. The X-Series has Single and Cont keys in place of the SweepSingleCont key. In the X-Series, if in single measurement, the Cont key (and INIT:CONT ON ) switches to continuous measurement, but never restarts a measurement and never resets a sweep.
<b>Initial S/W Revision</b>	Prior to A.02.00

In Swept SA Measurement (Spectrum Analysis Mode):

The analyzer takes repetitive sweeps, averages, measurements, etc., when in Continuous mode. When the average count reaches the Average/Hold Number the count stops incrementing, but the analyzer keeps sweeping. See the Trace/Detector section for the averaging formula used both before and after the Average/Hold Number is reached. The trigger condition must be met prior to each sweep. The type of trace processing for multiple sweeps, is set under the Trace/Detector key, with choices of Trace Average, Max Hold, or Min Hold.

In Other Measurements/Modes:

With Avg/Hold Num (in the Meas Setup menu) set to Off or set to On with a value of 1, a sweep is taken after the trigger condition is met; and the analyzer continues to take new sweeps after the current sweep has completed and the trigger condition is again met. However, with Avg/Hold Num set to On with a value >1, multiple sweeps (data acquisitions) are taken for the measurement. The trigger condition must be met prior to each sweep. The sweep is not stopped when the average count k equals the number N set for Avg/Hold Num is reached, but the number k stops incrementing. A measurement average usually applies to all traces, marker results, and numeric results. But sometimes it only applies to the numeric results.

If the analyzer is in Single measurement, pressing the Cont key does not change k and does not cause the sweep to be reset; the only action is to put the analyzer into Continuous measurement operation.

If it is already in continuous sweep:

the INIT:CONT 1 command has no effect



the INIT:CONT 0 command will place the analyzer in Single Sweep but will have no effect on the current sequence until  $k = N$ , at which point the current sequence will stop and the instrument will go to the idle state.

11 APD Measurement  
File

File

See "File" on page 266

## FREQ Channel

Displays the menu keys that enable you to control the frequency parameters.

Key Path	Front-panel key
Notes	Front panel only.
Initial S/W Revision	A.13.00

### Frequency

Sets the frequency of Meters in the Frequency Scan measurement. For the Strip Chart measurement, this key will set the frequency for both meters and strip chart. For APD measurement, this key is used to set the frequency to perform Amplitude Probability Distribution. For Monitor Spectrum measurement, this key is used to set the Center Frequency.

Key Path	FREQ Channel
<b>Remote Command</b>	<code>[ :SENSe ] :FREQuency:CENTer &lt;frequency&gt;</code> <code>[ :SENSe ] :FREQuency:CENTer ?</code>
<b>Example</b>	FREQ:CENT 3 GHZ FREQ:CENT?
Notes	For the Frequency Scan measurement, when QPD, EMI Average or RMS Average detectors is selected, you will see some delay for meters to reflect the new data due to filtering time. However, if the change in the meters frequency is performed by knob or step keys, there will be no filtering time added unless the change of the meters frequency has triggered other parameter changes.
Preset	515 MHz
State Saved	Saved in instrument state.
Min	For Frequency Scan and Strip Chart measurements, it depends on the instrument minimum frequency.
Max	For Frequency Scan, and Strip Chart measurements, it depends on the instrument maximum frequency.
Default Unit	Hz
Status Bits/OPC dependencies	non-overlapped
<b>Backwards Compatibility SCPI</b>	<code>:SENSe1   SENSe2   [SENSe] :FREQuency:CENTer</code> <code>:SENSe1   SENSe2   [SENSe] :FREQuency:FIXed</code>
Backwards Compatibility SCPI Notes	These commands above are included for ESU compatibility. The suffix 1 2 is irrelevant to the measurement, they are added solely for remote language compatibility.
Initial S/W Revision	A.07.00

### Freq/ Step

Changes the step size for the Frequency.

Key Path	FREQ Channel
Remote Command	[ :SENSe ] :FREQuency:CENTer:STEP [ :INCRement ] <freq> [ :SENSe ] :FREQuency:CENTer:STEP [ :INCRement ] ? [ :SENSe ] :FREQuency:CENTer:STEP:AUTO OFF ON 0 1 [ :SENSe ] :FREQuency:CENTer:STEP:AUTO?
Example	FREQ:CENT:STEP:AUTO ON FREQ:CENT:STEP 500 MHz FREQ:CENT UP increases the current center frequency value by 500 MHz FREQ:CENT:STEP? FREQ:CENT:STEP:AUTO?
Notes	Preset and Max values are dependent on Hardware Options (503, 508, 513, 526)
Preset	Auto ON
State Saved	Saved in instrument state
Min	- ( the maximum frequency of the instrument). (that is, a 27 GHz max freq instrument has a CF step range of +/- 27 GHz)
Max	The maximum frequency of the instrument. (that is, a 27 GHz max freq instrument has a CF step range of +/- 27 GHz)
Default Unit	Hz
Status Bits/OPC dependencies	non-overlapped
Initial S/W Revision	A.07.00

### Freq → Signal (Replace)

Replaces the frequency of the selected signal with the set Frequency. Trace, Disturbance level (E meas), Probability of Time (p meas) and Delta To Limit values will be shown as "--" to indicate that those values are undefined. TimeStamp will be updated. Signal list will be re-sorted based on the auto sort setting.

Key Path	FREQ Channel
Remote Command	:CALCulate:APD:SLIS:REPLace <integer>
Example	CALC:APD:SLIS:REPL 2 Replace Signal #2 with Freq
Notes	If the signal list contains no data, an error is generated and this function cannot be performed. If the selected signal is not in the list, an error is generated and this function cannot be performed.
Initial S/W Revision	A.13.00

### Freq → List (Append)

Append the set Frequency to the signal list. Trace, Disturbance level (E meas), Probability of Time (p meas) and Delta To Limit values will be shown as "--" to indicate that those values are undefined.

Key Path	FREQ Channel
<b>Remote Command</b>	:CALCulate:APD:SLIS:APPend
<b>Example</b>	CALC:APD:SLIS:APP
Notes	<p>If there is no free space in the signal list, you will be prompted by a message that asks whether to continue or not: WARNING! There is not enough free space in Signal List. Would you like to clear the Signal list before adding signals? Press ENTER to continue or ESC to Cancel.</p> <p>If you send the SCPI command when there is no free space in the signal list, the application will just clear the signal list. The information message is only for key presses.</p>
Couplings	The newly added signal will become the selected signal in the list.
Initial S/W Revision	A.13.00

11 APD Measurement  
Input/Output

## Input/Output

See ["Input/Output" on page 150](#)

## Marker

This displays a menu that enables you to set the marker control mode to Normal, Delta or Off.

If the selected marker is Off, pressing Marker sets it to Normal and places it at probability of 10<sup>-1</sup> (Or at a point after the probability of 10<sup>-1</sup> if the latter point does not exists) on the trace determined by the Marker Trace rules. At the same time, the Marker X Axis Value appears on the Active Function area.

The Active function for the selected marker's current control mode is the default active function. If the current control mode is Off, there is no active function and the active function is turned off. The active function display is the marker X axis value entered in the active function area, which will display the marker value to its full entered precision.

All interactions and dependencies detailed under the key description are enforced when the remote command is sent.

Key Path	Front-panel key
Remote Command	:CALCulate:APD:MARKer[1] 2 ... 12:MODE Position DELTA OFF :CALCulate:APD:MARKer[1] 2 ... 12:MODE?
Example	CALC:APD:MARK1:MODE POS CALC:APD:MARK:MODE?
Notes	If the selected marker is Off, pressing Marker sets it to Normal and places it at the center of the screen on the trace determined by the Marker Trace rules. At the same time, the Marker X Axis Value appears on the Active Function area.  Default Active Function: the active function for the selected marker's current control mode. If the current control mode is Off, there is no active function and the active function is turned off.  Active Function Display: the marker X axis value entered in the active function area will display the marker value to its full entered precision.
Preset	OFF
State Saved	Saved in instrument state.
Range	Normal Delta Off
Initial S/W Revision	A.13.00

Remote Command	:CALCulate:APD:MARKer[1] 2 ... 12:X <rel_ampl> :CALCulate:APD:MARKer[1] 2 ... 12:X?
Example	CALC:APD:MARK3:X 0 CALC:APD:MARK3:X?
Notes	If no suffix is sent, it will use the fundamental units for the current marker X Axis Scale. If a suffix is sent that does not match the current marker X Axis Scale unit, an error "Invalid suffix" will be generated.  The query returns the marker's absolute X Axis value if the control mode is Normal, or the offset from the marker's reference marker if the control mode is Delta. The query is returned in the fundamental units for the current marker X Axis scale: Hz for Frequency, seconds for Time, dB for Amplitude. If the

	marker is Off the response is not a number.
Preset	After a preset, all Markers are turned OFF, so Marker X Axis Value query will return a not a number (NAN).
State Saved	No
Min	25 dBuV
Max	124.99 dBuV
Initial S/W Revision	A.13.00

<b>Remote Command</b>	:CALCulate:APD:MARKer[1] 2 ... 12:Y?
<b>Example</b>	CALC:APD:MARK11:Y?
Notes	The query returns the marker Y-axis result, if the control mode is Normal, or Delta. If the marker is Off the response is not a number.
Preset	0
State Saved	No
Initial S/W Revision	A.13.00

## Select Marker

Accesses a menu that allows you to select one of 12 markers for control and function.

Key Path	Marker
Initial S/W Revision	A.13.00

## Normal

Sets the control mode for the selected marker to Normal and turns on the active function for setting its value. If the selected marker was off, it is placed at the beginning the trace.

A Normal mode (POSition type) marker can be moved to any point on the X Axis by specifying its X Axis value.

Key Path	Marker
<b>Example</b>	CALC:APD:MARK:MODE POS Sets Marker 1 to Normal.
Couplings	The marker addressed by this command becomes the selected marker on the front panel.
State Saved	Saved in instrument state.
Initial S/W Revision	A.13.00



## Delta

Sets the control mode for the selected marker to Delta and turns on the active function for setting its delta value. If the selected marker is off, the marker is placed at the beginning of the trace.

In Delta mode, the marker result shows the relative result between the selected (Delta) marker and its reference marker. A delta marker can be moved to any point on the X Axis by specifying its X Axis offset from a reference marker. Its absolute Y Axis value is then the value of the trace point at that X Axis value.

Key Path	Marker
<b>Example</b>	CALC:APD:MARK:MODE DELT Sets marker 1 to Delta.
Dependencies	The marker addressed by this command becomes the selected marker on the front panel.
State Saved	Saved in instrument state.
Initial S/W Revision	A.13.00

## Off

Turns off the selected marker, removes the marker annunciation from the display, and turns off any active function. Turning the marker off does not affect which marker is selected.

Key Path	Marker
<b>Example</b>	CALC:APD:MARK:MODE OFF Sets Marker 1 to Off.
State Saved	Saved in instrument state.
Initial S/W Revision	A.13.00

## Properties

Accesses the marker properties menu.

Key Path	Marker
Initial S/W Revision	A.13.00

## Select Marker

Accesses a menu that allows you to select one of 12 markers for control and function.

Key Path	Marker
Initial S/W Revision	A.13.00

## Relative To

This sets the reference marker that the selected marker will be relative to.

Key Path	Marker, Properties
Remote Command	:CALCulate:APD:MARKer[1] 2 ... 12:REFerence <integer> :CALCulate:APD:MARKer[1] 2 ... 12:REFerence?
Example	CALC:APD:MARK1:REF 3 CALC:APD:MARK2:REF?
Notes	A marker cannot be relative to itself so that choice is grayed out, and if sent from SCPI generates error -221: "Settings conflict; marker cannot be relative to itself." When queried a single value will be returned (the specified marker numbers relative marker).
Preset	2 3 4 5 6 7 8 9 10 11 12 1
State Saved	Saved in instrument state
Min	1
Max	12
Initial S/W Revision	A.13.00

## Marker Trace

This assigns the specified marker to the designated trace.

Key Path	Marker, Properties
Remote Command	:CALCulate:APD:MARKer[1] 2 ... 12:TRACe MEAS MEAS2 ELIMit :CALCulate:APD:MARKer[1] 2 ... 12:TRACe?
Example	CALC:APD:MARK3:TRAC MEAS CALC:APD:MARK2:TRAC?
Preset	Measured  Measured 2  Exceeded Limit
State Saved	Saved in instrument state
Range	Measured
Initial S/W Revision	A.13.00

## Couple Markers

When this function is true, moving any marker causes an equal X axis movement of every other marker which is not Off. By "equal X axis movement" we mean that we preserve the difference between each marker's X axis value (in the fundamental x-axis units of the trace that marker is on) and the X axis value of the marker being moved (in the same fundamental x-axis units).

Key Path	Marker
Remote Command	:CALCulate:APD:MARKer:COUPle[:STATe] OFF ON 0 1 :CALCulate:APD:MARKer:COUPle[:STATe]?
Example	CALC:APD:MARK:COUP ON Sets Couple Markers on.

Preset	Off, presets on Mode Preset and All Markers Off
State Saved	Saved in instrument state.
Initial S/W Revision	A.13.00

## All Markers Off

This turns off all the markers.

Key Path	Marker
<b>Remote Command</b>	:CALCulate:APD:MARKer:AOff
<b>Example</b>	CALC:APD:MARK:AOff
Initial S/W Revision	A.13.00

## Backwards Compatibility SCPI Commands

"Normal Marker State" on page 923

"Normal Marker X Axis Value" on page 923

"Normal Marker Y Axis Value" on page 924

"Delta Marker State" on page 924

"Delta Marker X Axis Value" on page 924

"Delta Marker Y Axis Value" on page 925

## Normal Marker State

Enables you to toggle the Normal marker state on/off.

<b>Remote Command</b>	:CALCulate[1] 2:MARKer[1] 2 ... 4[:STATE] ON OFF 1 0 :CALCulate[1] 2:MARKer[1] 2 ... 4[:STATE]?
<b>Example</b>	CALC:MARK4 ON Turn on maker 4 in Normal mode.
Notes	This SCPI is alias to :CALC:APD:MARK[1]2 3 4:MODE POS.
Preset	OFF
Initial S/W Revision	A.13.00

## Normal Marker X Axis Value

Enables you to set the selected marker to Normal mode, and sets/ gets the marker X Axis Values.

<b>Remote Command</b>	:CALCulate[1] 2:MARKer[1] 2 ... 4:X <value> :CALCulate[1] 2:MARKer[1] 2 ... 4:X?
-----------------------	---

<b>Example</b>	CALC:MARK3:X 30 Turn on maker 3 in Normal mode, by default will set the marker amplitude to 30 dBuV. CALC:MARK3:X? Turn on maker 3 in Normal mode and query the X axis value.
Notes	This SCPI is alias to :CALC:APD:MARK[1]2 3 4:MODE POS; :CALC:APD:MARK[1]2 3 4:X?
Preset	25 dBuV
Initial S/W Revision	A.13.00

### Normal Marker Y Axis Value

Enables you to set the selected marker to Normal mode, and gets the marker YAxis Values.

<b>Remote Command</b>	:CALCulate[1]2:MARKer[1]2 ... 4:Y?
<b>Example</b>	CALC:MARK3:Y? Turn on maker 3 in Normal mode and query the Y axis value.
Notes	This SCPI is alias to :CALC:APD:MARK[1]2 3 4:MODE POS; :CALC:APD:MARK[1]2 3 4:Y?
Initial S/W Revision	A.13.00

### Delta Marker State

Enables you to toggle the Delta marker state on/off.

<b>Remote Command</b>	:CALCulate[1]2:DELTamarker[1]2 ... 4[:STATE] ON OFF 1 0 :CALCulate[1]2:DELTamarker[1]2 ... 4[:STATE]?
<b>Example</b>	CALC:DELT3 ON Turn on maker 3 in Delta mode.
Notes	This SCPI is alias to :CALC:APD:MARK[1]2 3 4:MODE DELT.
Preset	OFF
Initial S/W Revision	A.13.00

### Delta Marker X Axis Value

Enables you to set the selected marker to Delta mode, and sets/ gets the marker X Axis Values. The command input, in relative values, refers to the reference marker while the query always returns absolute values in order to make it compatible with ESU.

<b>Remote Command</b>	:CALCulate[1]2:DELTamarker[1]2 ... 4:X <value> :CALCulate[1]2:DELTamarker[1]2 ... 4:X?
<b>Example</b>	CALC:DELT3:X 30 Turn on maker 3 in Delta mode, set the relative delta marker amplitude to 30 dB. CALC:DELT3:X? Turn on maker 3 in Delta mode and query the X axis value.
Notes	This SCPI is alias to :CALC:APD:MARK[1]2 3 4:MODE DELT; :CALC:APD:MARK[1]2 3 4:X? returns the relative values when marker in Delta mode.
Preset	25 dBuV
Initial S/W Revision	A.13.00

## Delta Marker Y Axis Value

Enables you to set the selected marker to Delta mode, and gets the marker Y Axis Values. The output is always a relative value referred to the reference marker.

<b>Remote Command</b>	:CALCulate [1]   2 : DELTAmarker [1]   2   ...   4 : Y?
<b>Example</b>	CALC:DELT3:Y? Turn on maker 3 in Normal mode and query the Y axis relative value.
<b>Notes</b>	This SCPI is alias to :CALC:APD:MARK[1]2 3 4:MODE DELT; :CALC:APD:MARK[1]2 3 4:Y?
<b>Initial S/W Revision</b>	A.13.00

## Marker ->

Displays the menu keys that enable you to append new elements into the existing signal list.

Key Path	Front-panel key
Notes	Front panel only.
Initial S/W Revision	A.13.00

## Marker → List

Appends the frequency, Disturbance level (E meas), Probability of Time ( $p$  meas) where the selected marker stays in the signal list. Trace at which the marker is located will be reflected in the Trace column. Delta To Limit values will be shown as “---“ to indicate the value is undefined.

Key Path	Marker To
<b>Remote Command</b>	:CALCulate:APD:MARKer[1] 2 ... 12[:SET]:SLIST
<b>Example</b>	CALC:APD:MARK2:SLIS
Notes	<p>If there is no free space in the signal list, a message will prompt you asking whether to continue:  <b>WARNING! There is not enough free space in Signal List. Would you like to clear the Signal list before adding signals? Press ENTER to continue or ESC to Cancel.</b></p> <p>If you send the SCPI command when there is no free space in the signal list, the application will just clear the signal list. The prompt message is only for key presses.</p>
Couplings	If there is no marker turned ON when this operation is performed, the default marker will be turned on. The newly added signal will become the selected signal in the list.
Initial S/W Revision	A.13.00

## MarkerFunction

There is no Marker Function supported in APD measurement. The front-panel key will display a blank menu when pressed.

Key Path	Front-panel key
Notes	Front-panel only.
Initial S/W Revision	A.13.00

## Meas

The information in this section is common to all measurements. For key and remote command information for a specific measurement, refer to the section that describes the measurement of interest.

Measurements available under the Meas key are specific to the current Mode.

When viewing Help for measurements, note the following:

**NOTE**

Operation for some keys differs between measurements. The information displayed in Help pertains to the current measurement. To see how a key operates in a different measurement, exit Help (press the Cancel Esc key), select the measurement, then reenter Help (press the Help key) and press that key.

---

Key Path	Front-panel key
Initial S/W Revision	Prior to A.02.00

---

### Remote Measurement Functions

This section contains the following topics:

["Measurement Group of Commands" on page 1048](#)

["Current Measurement Query \(Remote Command Only\)" on page 1050](#)

["Limit Test Current Results \(Remote Command Only\)" on page 1050](#)

["Data Query \(Remote Command Only\)" on page 1050](#)

["Calculate/Compress Trace Data Query \(Remote Command Only\)" on page 1051](#)

["Calculate Peaks of Trace Data \(Remote Command Only\)" on page 1056](#)

[Hardware-Accelerated Fast Power Measurement \(Remote Command Only\)](#)

["Format Data: Numeric Data \(Remote Command Only\)" on page 1057](#)

["Format Data: Byte Order \(Remote Command Only\)" on page 1058](#)

---

Initial S/W Revision	Prior to A.02.00
----------------------	------------------

---



## Measurement Group of Commands

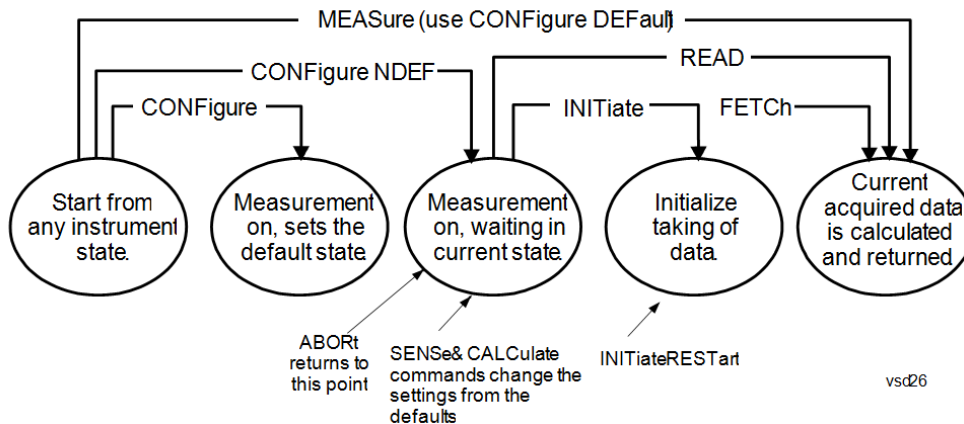

---

### Measure Commands:

:MEASure:<measurement>[n]?

This is a fast single-command way to make a measurement using the factory default instrument settings. These are the settings and units that conform to the Mode Setup settings (e.g. radio standard) that you have currently selected.

- Stops the current measurement (if any) and sets up the instrument for the specified measurement using the factory defaults
- Initiates the data acquisition for the measurement
- Blocks other SCPI communication, waiting until the measurement is complete before returning results.
- If the function does averaging, it is turned on and the number of averages is set to 10.
- After the data is valid it returns the scalar results, or the trace data, for the specified measurement. The type of data returned may be defined by an [n] value that is sent with the command.
- The scalar measurement results will be returned if the optional [n] value is not included, or is set to 1. If the [n] value is set to a value other than 1, the selected trace data results will be returned. See each command for details of what types of scalar results or trace data results are available.
- ASCII is the default format for the data output. (Older versions of Spectrum Analysis and Phase Noise mode measurements only use ASCII.) The binary data formats should be used for handling large blocks of data since they are smaller and faster than the ASCII format. Refer to the FORMat:DATA command for more information.

If you need to change some of the measurement parameters from the factory default settings you can set up the measurement with the CONFIGure command. Use the commands in the SENSe:<measurement> and CALCulate:<measurement> subsystems to change the settings. Then you can use the READ? command to initiate the measurement and query the results.

If you need to repeatedly make a given measurement with settings other than the factory defaults, you can use the commands in the SENSe:<measurement> and CALCulate:<measurement> subsystems to set up the measurement. Then use the READ? command to initiate the measurement and query results.

Measurement settings persist if you initiate a different measurement and then return to a previous one. Use READ:<measurement>? if you want to use those persistent settings. If you want to go back to the default settings, use MEASure:<measurement>?.

---

### Configure Commands:

:CONFigure:<measurement>

This command stops the current measurement (if any) and sets up the instrument for the specified measurement using

---

---

the factory default instrument settings. It does not initiate the taking of measurement data unless INIT:CONTinuous is ON. If you change any measurement settings after using the CONFigure command, the READ command can be used to initiate a measurement without changing the settings back to their defaults.

In the Swept SA measurement in Spectrum Analyzer mode the CONFigure command also turns the averaging function on and sets the number of averages to 10 for all measurements.

:CONFigure: <measurement>: NDEFault stops the current measurement and changes to the specified measurement. It does not change the settings to the defaults. It does not initiate the taking of measurement data unless INIT:CONTinuous is ON.

The CONFigure? query returns the current measurement name.

The CONFigure:CATalog? query returns a quoted string of all licensed measurement names in the current mode. For example, "SAN, CHP, OBW, ACP, PST, TXP, SPUR, SEM, LIST".

---

#### Fetch Commands:

---

:FETCh:<measurement>[n]?

This command puts selected data from the most recent measurement into the output buffer. Use FETCh if you have already made a good measurement and you want to return several types of data (different [n] values, for example, both scalars and trace data) from a single measurement. FETCh saves you the time of re-making the measurement. You can only FETCh results from the measurement that is currently active, it will not change to a different measurement. An error message is reported if a measurement other than the current one is specified.

If you need to get new measurement data, use the READ command, which is equivalent to an INITiate followed by a FETCh.

The scalar measurement results will be returned if the optional [n] value is not included, or is set to 1. If the [n] value is set to a value other than 1, the selected trace data results will be returned. See each command for details of what types of scalar results or trace data results are available. The binary data formats should be used for handling large blocks of data since they are smaller and transfer faster than the ASCII format. (FORMat:DATA)

FETCh may be used to return results other than those specified with the original READ or MEASure command that you sent.

---

#### INITiate Commands:

---

:INITiate:<measurement>

This command is not available for measurements in all the instrument modes:

- Initiates a trigger cycle for the specified measurement, but does not output any data. You must then use the FETCh<meas> command to return data. If a measurement other than the current one is specified, the instrument will switch to that measurement and then initiate it.
  - For example, suppose you have previously initiated the ACP measurement, but now you are running the channel power measurement. If you send INIT:ACP? it will change from channel power to ACP and will initiate an ACP measurement.
  - Does not change any of the measurement settings. For example, if you have previously started the ACP measurement and you send INIT:ACP? it will initiate a new ACP measurement using the same instrument settings as the last time ACP was run.
  - If your selected measurement is currently active (in the idle state) it triggers the measurement, assuming the trigger conditions are met. Then it completes one trigger cycle. Depending upon the measurement and the number of averages, there may be multiple data acquisitions, with multiple trigger events, for one full trigger cycle. It also holds off additional commands on GPIB until the acquisition is complete.
- 

#### READ Commands:

---

:READ:<measurement>[n]?

- Does not preset the measurement to the factory default settings. For example, if you have previously initiated the ACP
-

---

measurement and you send READ:ACP? it will initiate a new measurement using the same instrument settings.

- Initiates the measurement and puts valid data into the output buffer. If a measurement other than the current one is specified, the instrument will switch to that measurement before it initiates the measurement and returns results.
  - For example, suppose you have previously initiated the ACP measurement, but now you are running the channel power measurement. Then you send READ:ACP? It will change from channel power back to ACP and, using the previous ACP settings, will initiate the measurement and return results.
  - Blocks other SCPI communication, waiting until the measurement is complete before returning the results
  - If the optional [n] value is not included, or is set to 1, the scalar measurement results will be returned. If the [n] value is set to a value other than 1, the selected trace data results will be returned. See each command for details of what types of scalar results or trace data results are available. The binary data formats should be used when handling large blocks of data since they are smaller and faster than the ASCII format. (FORMat:DATA)
- 

---

Initial S/W Revision	Prior to A.02.00
----------------------	------------------

---

### Current Measurement Query (Remote Command Only)

This command returns the name of the measurement that is currently running.

---

<b>Remote Command</b>	:CONFigure?
-----------------------	-------------

<b>Example</b>	CONF?
----------------	-------

Initial S/W Revision	Prior to A.02.00
----------------------	------------------

---

### Limit Test Current Results (Remote Command Only)

Queries the status of the current measurement limit testing. It returns a 0 if the measured results pass when compared with the current limits. It returns a 1 if the measured results fail any limit tests.

---

<b>Remote Command</b>	:CALCulate:CLIMits:FAIL?
-----------------------	--------------------------

<b>Example</b>	CALC:CLIM:FAIL? queries the current measurement to see if it fails the defined limits. Returns a 0 or 1: 0 it passes, 1 it fails.
----------------	--

Initial S/W Revision	Prior to A.02.00
----------------------	------------------

---

### Data Query (Remote Command Only)

Returns the designated measurement data for the currently selected measurement and subopcode.

n = any valid subopcode for the current measurement. See the measurement command results table for your current measurement, for information about what data is returned for the subopcodes.

This command uses the data setting specified by the FORMat:BORDER and FORMat:DATA commands and can return real or ASCII data. (See the format command descriptions under Input/Output in the Analyzer Setup section.)

<b>Remote Command</b>	:CALCulate:DATA[n]?
<b>Notes</b>	The return trace depends on the measurement. In CALCulate:<meas>:DATA[n], n is any valid subopcode for the current measurement. It returns the same data as the FETCH:<measurement>? query where <measurement> is the current measurement.
<b>Initial S/W Revision</b>	Prior to A.02.00

### Calculate/Compress Trace Data Query (Remote Command Only)

Returns compressed data for the currently selected measurement and sub-opcode [n].

n = any valid sub-opcode for that measurement. See the MEASure:<measurement>? command description of your specific measurement for information on the data that can be returned.

The data is returned in the current Y Axis Unit of the analyzer. The command is used with a sub-opcode <n> (default=1) to specify the trace. With trace queries, it is best if the analyzer is not sweeping during the query. Therefore, it is generally advisable to be in Single Sweep, or Update=Off.

This command is used to compress or decimate a long trace to extract and return only the desired data. A typical example would be to acquire N frames of GSM data and return the mean power of the first burst in each frame. The command can also be used to identify the best curve fit for the data.

<b>Remote Command</b>	:CALCulate:DATA<n>:COMPRESS? BLOCK   CFIT   MAXimum   MINimum   MEAN   DMEan   RMS   RMSCubed   SAMPLE   SDEVIation   PPHase [,<soffset> [,<length>[,<roffset>[,<rlimit>]]]]
<b>Example</b>	To query the mean power of a set of GSM bursts: Supply a signal that is a set of GSM bursts. Select the IQ Waveform measurement (in IQ Analyzer Mode). Set the sweep time to acquire at least one burst. Set the triggers such that acquisition happens at a known position relative to a burst. Then query the mean burst levels using, CALC:DATA2:COMP? MEAN, 24e-6, 526e-6 (These parameter values correspond to GSM signals, where 526e-6 is the length of the burst in the slot and you just want 1 burst.)
<b>Notes</b>	The command supports 5 parameters. Note that the last 4 (<soffset>, <length>, <roffset>, <rlimit>) are optional. But these optional parameters must be entered in the specified order. For example, if you want to specify <length>, then you must also specify <soffset>. See details below for a definition of each of these parameters.  This command uses the data in the format specified by FORMat:DATA, returning either binary or ASCII data.
<b>Initial S/W Revision</b>	Prior to A.02.00

- BLOCK or block data - returns all the data points from the region of the trace data that you specify. For example, it could be used to return the data points of an input signal over several timeslots, excluding the portions of the trace data that you do not want. (This is x,y pairs for trace data and I,Q pairs for complex data.)

- CFIT or curve fit - applies curve fitting routines to the data. <soffset> and <length> are required to define the data that you want. <roffset> is an optional parameter for the desired order of the curve equation. The query will return the following values: the x-offset (in seconds) and the curve coefficients ((order + 1) values).

MIN, MAX, MEAN, DME, RMS, RMSC, SAMP, SDEV and PPH return one data value for each specified region (or <length>) of trace data, for as many regions as possible until you run out of trace data (using <roffset> to specify regions). Or they return the number of regions you specify (using <rlimit>) ignoring any data beyond that.

- MINimum - returns the minimum data point (y value) for the specified region(s) of trace data. For I/Q trace data, the minimum magnitude of the I/Q pairs is returned.
- MAXimum - returns the maximum data point (y value) for the specified region(s) of trace data. For I/Q trace data, the maximum magnitude of the I/Q pairs is returned.
- MEAN - returns a single value that is the arithmetic mean of the data point values (in dB/ dBm) for the specified region(s) of trace data. For I/Q trace data, the mean of the magnitudes of the I/Q pairs is returned. See the following equations.

- 

**NOTE**

If the original trace data is in dB, this function returns the arithmetic mean of those log values, not log of the mean power which is a more useful value. The mean of the log is the better measurement technique when measuring CW signals in the presence of noise. The mean of the power, expressed in dB, is useful in power measurements such as Channel Power. To achieve the mean of the power, use the RMS option.

Equation 1

Mean Value of Data Points for Specified Region(s)

$$\text{MEAN} = \frac{1}{n} \sum_{X_i \in \text{region}(s)} X_i$$

where  $X_i$  is a data point value, and  $n$  is the number of data points in the specified region(s).

Equation 2

Mean Value of I/Q Data Pairs for Specified Region(s)

$$\text{MEAN} = \frac{1}{n} \sum_{X_i \in \text{region}(s)} |X_i|$$

where  $|X_i|$  is the magnitude of an I/Q pair, and  $n$  is the number of I/Q pairs in the specified region(s).

- DMEan - returns a single value that is the mean power (in dB/ dBm) of the data point values for the specified region(s) of trace data. See the following equation:

Equation 3

DMEan Value of Data Points for Specified Region(s)

$$\text{DME} = 10 \times \log_{10} \left( \frac{1}{n} \sum_{X_i \in \text{region}(s)} 10^{\frac{X_i}{10}} \right)$$

- RMS - returns a single value that is the average power on a root-mean-squared voltage scale (arithmetic rms) of the data point values for the specified region(s) of trace data. See the following equation.

**NOTE**

For I/Q trace data, the rms of the magnitudes of the I/Q pairs is returned. See the following equation. This function is very useful for I/Q trace data. However, if the original trace data is in dB, this function returns the rms of the log values which is not usually needed.

Equation 4

RMS Value of Data Points for Specified Region(s)

$$\text{RMS} = \sqrt{\frac{1}{n} \sum_{X_i \in \text{region}(s)} X_i^2}$$

where  $X_i$  is a data point value, and  $n$  is the number of data points in the specified region(s).

Equation 5

RMS Value of I/Q Data Pairs for Specified Region(s)

$$\text{RMS} = \sqrt{\frac{1}{n} \sum_{X_i \in \text{region}(s)} X_i X_i^*}$$

where  $X_i$  is the complex value representation of an I/Q pair,  $X_i^*$  its conjugate complex number, and  $n$  is the number of I/Q pairs in the specified region(s).

Once you have the rms value for a region of trace data (linear or I/Q), you may want to calculate the mean power. You must convert this rms value (peak volts) to power in dBm:

$$10 \times \log[10 \times (\text{rms value})^2]$$

- SAMPlE - returns the first data value (x,y pair) for the specified region(s) of trace data. For I/Q trace data, the first I/Q pair is returned.
- SDEViation - returns a single value that is the arithmetic standard deviation for the data point values for the specified region(s) of trace data. See the following equation.
- For I/Q trace data, the standard deviation of the magnitudes of the I/Q pairs is returned. See the following equation.

Equation 6

Standard Deviation of Data Point Values for Specified Region(s)

$$\text{SDEV} = \sqrt{\frac{1}{n} \sum_{X_i \in \text{region}(s)} (X_i - \bar{X})^2}$$

where  $X_i$  is a data point value,  $\bar{X}$  is the arithmetic mean of the data point values for the specified region (s), and  $n$  is the number of data points in the specified region(s).

$$\text{SDEV} = \sqrt{\frac{1}{n} \sum_{X_i \in \text{region}(s)} (|X_i| - \bar{X})^2}$$

where  $|X_i|$  is the magnitude of an I/Q pair,  $\bar{X}$  is the mean of the magnitudes for the specified region(s), and  $n$  is the number of data points in the specified region(s).

- PPHase - returns the x,y pairs of both rms power (dBm) and arithmetic mean phase (radian) for every specified region and frequency offset (Hz). The number of pairs is defined by the specified number of regions. This parameter can be used for I/Q vector ( $n=0$ ) in Waveform (time domain) measurement and all parameters are specified by data point in PPHase.

The rms power of the specified region may be expressed as:

$$\text{Power} = 10 \times \log [10 \times (\text{RMS I/Q value})] + 10.$$

The RMS I/Q value (peak volts) is:

$$\sqrt{\frac{1}{n} \sum_{X_i \in \text{region}} X_i X_i^*}$$

where  $X_i$  is the complex value representation of an I/Q pair,  $X_i^*$  its conjugate complex number, and  $n$  is the number of I/Q pairs in the specified region.

The arithmetic mean phase of the specified region may be expressed as:

$$\frac{1}{n} \sum_{Y_i \in \text{region}} Y_i$$

where  $Y_i$  is the unwrapped phase of I/Q pair with applying frequency correction and  $n$  is the number of I/Q pairs in the specified region.

The frequency correction is made by the frequency offset calculated by the arithmetic mean of every specified region's frequency offset. Each frequency offset is calculated by the least square method against the unwrapped phase of I/Q pair.

Sample Trace Data - Constant Envelope

(See below for explanation of variables.)

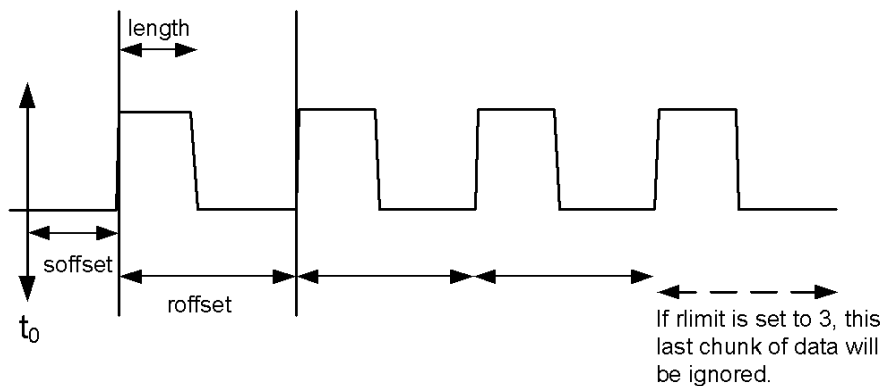

Sample Trace Data - Not Constant Envelope

(See below for explanation of variables.)

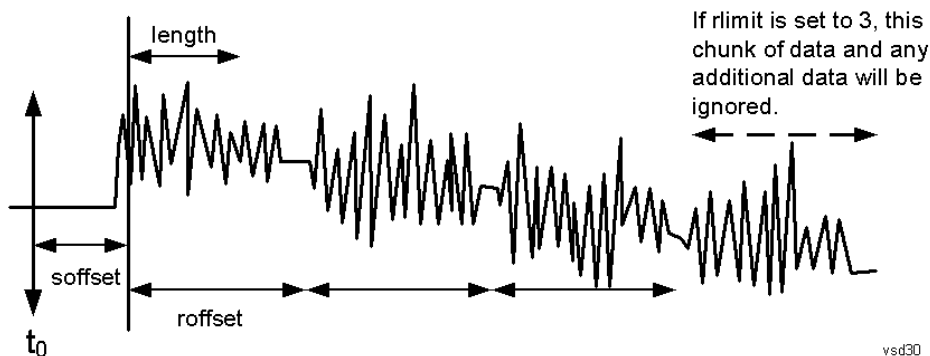

<soffset> - start offset is an optional real number. (It is in seconds for time-domain traces, and is a dimensionless index 0 to Npoints - 1, for frequency-domain traces). It specifies the amount of data at the beginning of the trace that will be ignored before the decimation process starts. It is the time or frequency change from the start of the trace to the point where you want to start using the data. The default value is zero.

<length> - is an optional real number. (It is in seconds for time-domain traces, and is a dimensionless index 0 to Npoints - 1, for frequency-domain traces). It defines how much data will be compressed into one value. This parameter has a default value equal to the current trace length.

<roffset> - repeat offset is an optional real number. (It is in seconds for time-domain traces, and is a dimensionless index 0 to Npoints - 1, for frequency-domain traces). It defines the beginning of the next field of trace elements to be compressed. This is relative to the beginning of the previous field. This parameter has a default value equal to the <length> variable. Note that this parameter is used for a completely different purpose when curve fitting (see CFIT above).

<rlimit> - repeat limit is an optional integer. It specifies the number of data items that you want returned. It will ignore any additional items beyond that number. You can use the Start offset and the Repeat limit to pick out exactly what part of the data you want to use. The default value is all the data.



## Calculate Peaks of Trace Data (Remote Command Only)

Returns a list of all the peaks for the currently selected measurement and sub-opcode [n]. The peaks must meet the requirements of the peak threshold and excursion values.

n = any valid sub-opcode for the current measurement. See the MEASure:<measurement> command description of your specific measurement for information on the data that can be returned.

The command can only be used with specific sub-opcodes with measurement results that are trace data. Both real and complex traces can be searched, but complex traces are converted to magnitude in dBm. In many measurements the sub-opcode n=0, is the raw trace data which cannot be searched for peaks. And Sub-opcode n=1, is often calculated results values which also cannot be searched for peaks.

This command uses the data setting specified by the FORMat:BORDER and FORMat:DATA commands and can return real or ASCII data. If the format is set to INT,32, it returns REAL,32 data.

The command has four types of parameters:

- Threshold (in dBm)
- Excursion (in dB)
- Sorting order (amplitude, frequency, time)
- Optional in some measurements: Display line use (all, > display line, < display line)

<b>Remote Command</b>	<p>For Swept SA measurement:</p> <pre>:CALCulate:DATA[1] 2 ... 6:PEAKs? &lt;threshold&gt;,&lt;excursion&gt;[,AMPLitude   FREQuency   TIME[,ALL   GTDLLine   LTDLine]]</pre> <p>For most other measurements:</p> <pre>:CALCulate:DATA[1] 2 ... 6:PEAKs? &lt;threshold&gt;,&lt;excursion&gt;[,AMPLitude   FREQuency   TIME]</pre>
-----------------------	---

<b>Example</b>	<p>Example for Swept SA measurement in Spectrum Analyzer Mode:</p> <p>CALC:DATA4:PEAK? -40, 10, FREQ, GTDL This will identify the peaks of trace 4 that are above -40 dBm, with excursions of at least 10 dB. The peaks are returned in order of increasing frequency, starting with the lowest frequency. Only the peaks that are above the display line are returned.</p> <p>Query Results 1:</p> <p>With FORMat:DATA REAL, 32 selected, it returns a list of floating-point numbers. The first value in the list is the number of peak points that are in the following list. A peak point consists of two values: a peak amplitude followed by its corresponding frequency (or time).</p> <p>If no peaks are found the peak list will consist of only the number of peaks, (0).</p>
----------------	---

<b>Notes</b>	<p>&lt;n&gt; - is the trace that will be used</p> <p>&lt;threshold&gt; - is the level below which trace data peaks are ignored. Note that the threshold value is required and is always used as a peak criterion. To effectively disable the threshold criterion for this command, provide a substantially low threshold value such as -200 dBm. Also note that the threshold value used in this command is independent of and has no effect on the threshold value stored under the Peak Criteria menu.</p> <p>&lt;excursion&gt; - is the minimum amplitude variation (rise and fall) required for a signal to be identified as peak. Note that the excursion value is required and is always used as a peak criterion. To effectively disable the excursion criterion for this command, provide the minimum value of 0.0 dB. Also note that the excursion value used in this command is independent of and has no effect on the</p>
--------------	---

---

excursion value stored under the Peak Criteria menu.

Values must be provided for threshold and excursion. The sorting and display line parameters are optional (defaults are AMPLitude and ALL).

Note that there is always a Y-axis value for the display line, regardless of whether the display line state is on or off. It is the current Y-axis value of the display line which is used by this command to determine whether a peak should be reported

Sorting order:

AMPLitude - lists the peaks in order of descending amplitude, with the highest peak first (default if optional parameter not sent)

FREQuency - lists the peaks in order of occurrence, left to right across the x-axis.

TIME - lists the peaks in order of occurrence, left to right across the x-axis.

Peaks vs. Display Line:

ALL - lists all of the peaks found (default if optional parameter not sent).

GTDLine (greater than display line) - lists all of the peaks found above the display line.

LTDLine (less than display line) - lists all of the peaks found below the display line.

---

Initial S/W Revision      Prior to A.02.00

---

### Format Data: Numeric Data (Remote Command Only)

This command specifies the format of the trace data input and output. It specifies the formats used for trace data during data transfer across any remote port. It affects only the data format for setting and querying trace data for the :TRACe[:DATA], TRACe[:DATA]?, :CALCulate:DATA[n]? and FETCh:SANalyzer [n]? commands and queries.

---

**Remote Command**      :FORMat [:TRACe] [:DATA] ASCii|INTeger,32|REAL,32 |REAL,64  
:FORMat [:TRACe] [:DATA] ?

---

**Notes**      The query response is:  
ASCii: ASC,8  
REAL,32: REAL,32  
REAL,64: REAL,64  
INTeger,32: INT,32

When the numeric data format is REAL or ASCii, data is output in the current Y Axis unit. When the data format is INTeger, data is output in units of m dBm (.001 dBm).

The INT,32 format returns binary 32-bit integer values in internal units (m dBm), in a definite length block.

---

**Dependencies**      Sending a data format spec with an invalid number (for example, INT,48) generates no error. The analyzer simply uses the default (8 for ASCii, 32 for INTeger, 32 for REAL).

Sending data to the analyzer which does not conform to the current FORMat specified, results in an error. Sending ASCII data when a definite block is expected generates message -161 "Invalid Block Data" and sending a definite block when ASCII data is expected generates message -121 "Invalid Character in Number".

---

**Preset**      ASCii

---

**Backwards Compatibility Notes**      Note that the INT,32 format is only applicable to the command, TRACe:DATA. This preserves backwards compatibility for the Swept SA measurement. For all other commands/queries which honor FORMat:DATA, if INT,32 is sent the analyzer will behave as though it were set to REAL,32.

---

Initial S/W Revision      Prior to A.02.00

---

The specs for each output type follow:

ASCIi - Amplitude values are in ASCII, in the current Y Axis Unit, one ASCII character per digit, values separated by commas, each value in the form:

SX.YYYYYEsZZ

Where:

S = sign (+ or -)

X = one digit to left of decimal point

Y = 5 digits to right of decimal point

E = E, exponent header

s = sign of exponent (+ or -)

ZZ = two digit exponent

REAL,32 - Binary 32-bit real values in the current Y Axis Unit, in a definite length block.

REAL,64 - Binary 64-bit real values in the current Y Axis Unit, in a definite length block.

### Format Data: Byte Order (Remote Command Only)

This command selects the binary data byte order for data transfer and other queries. It controls whether binary data is transferred in normal or swapped mode. This command affects only the byte order for setting and querying trace data for the :TRACe[:DATA], TRACe[:DATA]? , :CALCulate:DATA[n]? and FETCh:SANalyzer[n]? commands and queries.

By definition any command that says it uses FORMat:DATA uses any format supported by FORMat:DATA.

The NORMal order is a byte sequence that begins with the most significant byte (MSB) first, and ends with the least significant byte (LSB) last in the sequence: 1|2|3|4. SWAPPed order is when the byte sequence begins with the LSB first, and ends with the MSB last in the sequence: 4|3|2|1.

<b>Remote Command</b>	:FORMat:BORDER NORMal SWAPPed :FORMat:BORDER?
<b>Preset</b>	NORMal
<b>Initial S/W Revision</b>	Prior to A.02.00

## Meas Setup

Displays a menu of keys that enable you to set up the measurement.

Key Path	Front-panel key
Notes	Front panel only.
Initial S/W Revision	A.13.00

### Select Signal

Specifies the selected signal. The term “Selected signal” is used throughout this document to specify which signal will be affected by the functions.

Key Path	Meas Setup, Signal List
Notes	Front panel only. When Select Signal is the active function, press UP to go up in the signal list, and press DOWN to go down in the list.
Couplings	When the signal list is cleared, this value will reset to 0. Select Signal is auto coupled with Frequency Scan and Monitor Spectrum Selected signal.
Preset	If the signal list is empty, =0 If the signal list is not empty, = number of peaks in the signal list table
State Saved	Saved in instrument state.
Min	0
Max	Number of peaks in the signal list table.
Initial S/W Revision	A.13.00

### Meas Time

Specifies the measurement time for each sweep.

Key Path	Mode Setup
<b>Remote Command</b>	[ :SENSe ] :APD :SWEep :TIME <time> [ :SENSe ] :APD :SWEep :TIME ?
<b>Example</b>	APD:SWE:TIME 500ms APD:SWE:TIME?
Preset	100 ms
State Saved	Saved in instrument state.
Min	10 ms
Max	120 s
Default Unit	s
Initial S/W Revision	A.13.00

## Measure

Specifies the signal coverage for the automated APD measurement.

Key Path	Meas Setup
<b>Remote Command</b>	[ :SENSE ] :APD:MEAS ALL MARKed [ :SENSE ] :APD:MEAS?
<b>Example</b>	APD:MEAS ALL APD:MEAS?
Notes	ALL = All Signals MARKed = Marked Signals
Preset	ALL
State Saved	Saved in instrument state.
Range	All Signals  Marked Signals
Readback	All Signals  Marked Signals
Initial S/W Revision	A.13.00

## Limits

Opens the Limit Lines menu that contains keys to control limit lines of the current measurement.

Key Path	Meas Setup
State Saved	Saved in instrument state.
Initial S/W Revision	A.13.00

## Select Limit

Specifies the selected limit. The term “selected limit” is used throughout this document to specify which limit will be affected by the functions.

Key Path	Meas Setup, Limits
Notes	Front panel only. The selected limit is remembered even when not in the Limit Menu. Currently, there is only 1 limit line in this measurement. Limit line choices 2 through 6 will be grayed out.
Preset	Limit 1
State Saved	Saved in instrument state.
Initial S/W Revision	A.13.00

## Limit On/Off

Selects whether the limit is displayed. If Test Limits is on, this also determines whether the test trace (see "Test Trace" on page 943) will be tested against the limit. If Limit On/Off is On and the current frequency is within the defined limit frequency, the following occurs:

- The limit line is displayed, in the same color, but paler, as the limited trace. A red "+" sign shows the point of APD trace which fails the limit.
- "x Trace Pass/Fail" indication is displayed in the graticule if the test trace is on. If the trace is at or within the bounds of the applicable limits, the text "x Trace Pass" will be displayed in green. If the trace is outside the bounds of some applicable limits, the text "x Trace Fail" will be displayed in red

Note that a red + sign will be used to show the point that failed the limit line. The Test trace that is off will not be compared. In this case, the Invalid Data indicator (\*) will appear in the upper right corner, and no report of the trace passing or failing is seen on the graticule.

<b>Key Path</b>	Meas Setup, Limits
<b>Remote Command</b>	:CALCulate:APD:LLINE[1]:DISPlay ON OFF 1 0 :CALCulate:APD:LLINE[1]:DISPlay?
<b>Example</b>	CALC:APD:LLIN:DISP ON CALC:APD:LLIN:DISP?
<b>Couplings</b>	Turning ON Limit Display will turn ON Test Limits (All Limits).
<b>Preset</b>	OFF
<b>State Saved</b>	Saved in instrument state.
<b>Range</b>	On Off
<b>Initial S/W Revision</b>	A.13.00

## Properties

Accesses a menu that enables you to set the properties of the selected limit.

<b>Key Path</b>	Meas Setup, Limits
<b>Initial S/W Revision</b>	A.13.00

## Select Limit

Specifies the selected limit. The term "selected limit" is used throughout this document to specify which limit will be affected by the functions.

<b>Key Path</b>	Meas Setup, Limits
<b>Notes</b>	Front panel only. The selected limit is remembered even when not in the Limit Menu. Currently, there is only 1 limit line in this measurement. Limit line choices 2 through 6 will be grayed out.

Preset	Limit 1
State Saved	Saved in instrument state.
Initial S/W Revision	A.13.00

## Test Trace

Selects the trace that you want the limit to test.

Key Path	Meas Setup, Limits, Properties
<b>Remote Command</b>	:CALCulate:APD:LLINe[1]:TRACe MEAS MEAS2 :CALCulate:APD:LLINe[1]:TRACe?
<b>Example</b>	CALC:APD:LLIN:TRAC MEAS Applies limit 1 to Measured Trace.
Notes	When the trace is off, the trace is not tested. If the trace is on and Limit Display is on: a.If Test Limit is Off, the “Trace Pass/Fail” indication is displayed in the upper left corner of the graticule. b.If Test Limit is On, the “Trace Pass/Fail” indication is displayed in the upper left corner of the graticule, and the PASS/FAILbox is displayed in the left corner of the Meas Bar.
Couplings	This matters when testing a trace or limit line for failure, via :CALC:APD:LLIN:FAIL? or :CALC:APD:TRAC2:FAIL?
Preset	MEAS
State Saved	Saved in instrument state.
Range	Measured  Measured 2  Exceeded Limit
Initial S/W Revision	A.13.00

## Description

Provides a description of up to 60 characters by which you can easily identify the limit. The descriptions will be stored in the exported file and can be displayed in the active function area by selecting them as the active function, if desired to be in a screen capture.

Key Path	Meas Setup, Limits, Properties
<b>Remote Command</b>	:CALCulate:APD:LLINe[1]:DESCRiption “string” :CALCulate:APD:LLINe[1]:DESCRiption?
<b>Example</b>	CALC:APD:LLIN:DESC “European APD”
Preset	”” (null String), not affected by Mode Preset, preset by Restore Mode Defaults.
State Saved	Saved in instrument state.
Initial S/W Revision	A.13.00

### Comment

Sets an ASCII comment field, which will be stored in an exported file. The comment can be displayed in the active function area by selecting it as the active function, if desired to be in a screen capture. The Limits .csv file supports this field.

Key Path	Meas Setup, Limits, Properties
Remote Command	:CALCulate:APD:LLINE[1]:COMMENT "string" :CALCulate:APD:LLINE[1]:COMMENT ?
Example	CALC:APD:LLIN:COMM "European Emissions"
Preset	"" (null String), not affected by Mode Preset, preset by Restore Mode Defaults.
State Saved	Saved in instrument state.
Initial S/W Revision	A.13.00

### Edit Limit

Opens the Table Editor for the selected limit line.

Key Path	Meas Setup, Limits
Initial S/W Revision	A.13.00

### Navigate

Enables you to move through the table to edit the desired point.

Key Path	Meas Setup, Limits, Edit
Notes	There is no readback value on the key
Min	1
Max	2000
Initial S/W Revision	A.13.00

### Frequency

Enables you to edit the frequency of the current row.

Key Path	Meas Setup, Limits, Edit
Notes	There is no readback value on the key
Min	0
Max	1 THz
Initial S/W Revision	A.13.00



### Disturbance Level (E limit)/ Probability of Time ( $\rho$ limit)

Enables you to edit the disturbance level or probability of the current row. Depending on the APD Method, this key can be a Disturbance Level or Probability of Time.

Key Path	Meas Setup, Limits, Edit
Notes	There is no readback value on the key.
Min	-1000 dBm
Max	1000 dBm
Initial S/W Revision	A.13.00

Key Path	Meas Setup, Limits, Edit
Notes	There is no readback value on the key.
Initial S/W Revision	A.13.00

### APD Method

Selects the APD measurement method for the selected limit, either:

1. Disturbance Level: Compare a measured emission (E meas) against a limit emissions level (E limit) at a specified probability value.
2. Probability of Time: Compare a measured probability level ( $\rho$  meas) against a limit probability ( $\rho$  limit) level at a specified Emissions value.

Key Path	Meas Setup, Limits, Edit
<b>Remote Command</b>	:CALCulate:APD:LLINe[1]:METHod DLEVel PROBability :CALCulate:APD:LLINe[1]:METHod?
<b>Example</b>	CALC:APD:LLIN:METH DLEV CALC:APD:LLIN:METH
Dependencies	When Disturbance Level is selected, the limit table editor will show “Disturbance Level (E limit)” key. When Probability of Time is selected, the limit table editor will show “Prblty of Time ( $\rho$ limit)” key.
Preset	DLEVel
State Saved	Saved in instrument state.
Range	DLEVel PROBability
Initial S/W Revision	A.13.00

### Disturbance Level

Set the Limit APD method to Disturbance Level.

Key Path	Meas Setup, Limits, APD Method
<b>Example</b>	CALC:APD:LLIN:METH DLEV
State Saved	Saved in instrument state.
Initial S/W Revision	A.13.00

### Probability of Time (Constant)

Defines the probability where the Disturbance Level limit is applies to.

Key Path	Meas Setup, Limits, APD Method, Disturbance Level
<b>Remote Command</b>	:CALCulate:APD:LLINe[1]:METHod:DLEVel:PROBability N1   N2   N3   N4   N5   N6   N7  :CALCulate:APD:LLINe[1]:METHod:DLEVel:PROBability?
<b>Example</b>	CALC:APD:LLIN:METH:DLEV:PROB N2 Specified limit at probability of 10 <sup>-2</sup> . CALC:APD:LLIN:METH:DLEV:PROB?
Preset	N1
State Saved	Saved in instrument state.
Range	N1 N2 N3 N4 N5 N6 N7
Initial S/W Revision	A.13.00

### N1

Sets the Probability of Time constant to 10<sup>-1</sup>.

Key Path	Meas Setup, Limits, APD Method, Disturbance Level, Probability of Time
<b>Example</b>	CALC:APD:LLIN:METH:DLEV:PROB N1
Readback	10 <sup>-1</sup>
Initial S/W Revision	A.13.00

### N2

Sets the Probability of Time constant to 10<sup>-2</sup>.

Key Path	Meas Setup, Limits, APD Method, Disturbance Level, Probability of Time
<b>Example</b>	CALC:APD:LLIN:METH:DLEV:PROB N2
Readback	10 <sup>-2</sup>
Initial S/W Revision	A.13.00

## N3

Sets the Probability of Time constant to 10<sup>-3</sup>.

Key Path	Meas Setup, Limits, APD Method, Disturbance Level, Probability of Time
<b>Example</b>	CALC:APD:LLIN:METH:DLEV:PROB N3
Readback	10 <sup>-3</sup>
Initial S/W Revision	A.13.00

## N4

Sets the Probability of Time constant to 10<sup>-4</sup>.

Key Path	Meas Setup, Limits, APD Method, Disturbance Level, Probability of Time
<b>Example</b>	CALC:APD:LLIN:METH:DLEV:PROB N4
Readback	10 <sup>-4</sup>
Initial S/W Revision	A.13.00

## N5

Sets the Probability of Time constant to 10<sup>-5</sup>.

Key Path	Meas Setup, Limits, APD Method, Disturbance Level, Probability of Time
<b>Example</b>	CALC:APD:LLIN:METH:DLEV:PROB N5
Readback	10 <sup>-5</sup>
Initial S/W Revision	A.13.00

## N6

Sets the Probability of Time constant to 10<sup>-6</sup>.

Key Path	Meas Setup, Limits, APD Method, Disturbance Level, Probability of Time
<b>Example</b>	CALC:APD:LLIN:METH:DLEV:PROB N6
Readback	10 <sup>-6</sup>
Initial S/W Revision	A.13.00

## N7

Sets the Probability of Time constant to 10<sup>-7</sup>.

Key Path	Meas Setup, Limits, APD Method, Disturbance Level, Probability of Time
<b>Example</b>	CALC:APD:LLIN:METH:DLEV:PROB N7

Readback	10-7
Initial S/W Revision	A.13.00

### Probability of Time

Set the Limit APD method to Probability of Time.

Key Path	Meas Setup, Limits, APD Method
<b>Example</b>	CALC:APD:LLIN:METH PROB
State Saved	Saved in instrument state.
Initial S/W Revision	A.13.00

### Disturbance Level (Constant)

Defines the disturbance level where the Probability limit is applies to.

Key Path	Meas Setup, Limits, APD Method, Probability of Time
<b>Remote Command</b>	:CALCulate:APD:LLINE[1]:METHod:PROBability:DLEVel <ampl> :CALCulate:APD:LLINE[1]:METHod:PROBability:DLEVel?
<b>Example</b>	CALC:APD:LLIN:METH:PROB:DLEV 70 CALC:APD:LLIN:METH:PROB:DLEV?
Preset	dBuV
State Saved	Saved in instrument state.
Min	-250 dBuV
Max	250 dBuV
Default Unit	Depends on the currently selected amplitude axis unit(X Axis).
Initial S/W Revision	A.13.00

### Insert Point Below

Pressing this key inserts a point below the current point. The new point is a copy of the current point and becomes the current point. The new point is not yet entered into the underlying table, and the data in the row is displayed in light gray.

Key Path	Meas Setup, Limits, Edit
Initial S/W Revision	A.13.00

## Delete Point

Pressing this key immediately deletes the currently selected point, whether or not that point is being edited, or selected through Navigate. The point following the currently-selected point (or the point before this point if there is none) will be selected.

Key Path	Meas Setup, Limits, Edit
Initial S/W Revision	A.13.00

## Test Limits (All Limits)

Selects whether test traces are tested against the displayed limits (i.e. those for which Limit On/Off is set to On). If On, the PASS/FAIL box is displayed in the left corner of the Meas Bar.

This command only affects the display, and has no impact on remote behavior. Limit queries over SCPI test the trace against the limit regardless of whether the trace or the limit is turned on (exception: the query :CALCulate:APD:TRACe[1]|2|3:FAIL? tests only the limits that are turned on for that trace).

Key Path	Meas Setup, Limits
<b>Remote Command</b>	:CALCulate:APD:LLINe:TEST ON OFF 1 0 :CALCulate:APD:LLINe:TEST?
<b>Example</b>	CALC:APD:LLIN:TEST ON CALC:APD:LLIN:TEST?
Preset	On, not affected by Mode Preset, preset by Restore Mode Defaults.
State Saved	Saved in instrument state.
Range	On Off
Initial S/W Revision	A.13.00

## Delete Limit

Deletes the currently selected limit line. Pressing Delete Limit purges the data from the limit line tables. Limit data, including secondary parameters such as limit trace, description, comment, APD Method, etc..., will be cleared and returned to factory preset settings.

When this key is pressed a prompt is placed on the screen that says “Please press Enter or OK key to delete limit. Press ESC or Cancel to close this dialog.” The deletion is only performed if you press OK or Enter. After a deletion, the informational message “Limit deleted” appears in the MSG line.

Key Path	Meas Setup, Limits
<b>Remote Command</b>	:CALCulate:APD:LLINe [1] :DElete
<b>Example</b>	CALC:APD:LLIN3:DEL Deletes all data for limit line 3
Initial S/W Revision	A.13.00

## Delete All Limits

Deletes all limit lines. Pressing Delete All Limits purges the data from all limit line tables. All limit data will be cleared and returned to factory preset settings. However, since there is only 1 limit line in this measurement, pressing this key has the same result as Delete Limit.

When this key is pressed a prompt is placed on the screen that says “Please press Enter or OK key to delete all limits. Press ESC or Cancel to close this dialog.” The deletion is only performed if you press OK or Enter. After a deletion, the informational message “All Limits deleted” appears in the MSG line.

<b>Key Path</b>	Meas Setup, Limits
<b>Remote Command</b>	:CALCulate:APD:LLINe:ALL:DElete
<b>Example</b>	CALC:APD:LLIN:ALL:DEL
<b>Initial S/W Revision</b>	A.13.00

## Limit Line Fail? (Remote Command Only)

Tests a limit line against its associated APD trace. Returns a 0 if the Disturbance Level (E meas) at the specified Probability or Probability of time (p meas) at the specified Disturbance Level is within the limit, a 1 if the value exceeds either the limit.

Note this command performs the test regardless of whether the trace or the limit is turned on, on the display.

<b>Remote Command</b>	:CALCulate:APD:LLINe[1]:FAIL?
<b>Example</b>	CALC:APD:LLIN:FAIL? Returns a zero if limit line 1’s associated trace has no failure, 1 if there is a limit failure.
<b>Initial S/W Revision</b>	A.13.00

## Trace Fail? (Remote Command Only)

Tests a trace against all associated limit lines. Returns a 0 if the trace is within all limits, a 1 if the trace exceeds one or more of the limits. If no limits apply to the selected trace, this will automatically return a 0. Currently, there is only one limit line in this measurement.

Only applies to limits that are turned on, if a Limit is off it will not be tested. If a Trace is not displaying it will still be tested, and if Test Limits (All Limits) is off the Trace will still be tested.

This command ignores limit lines that are assigned to other traces.

<b>Remote Command</b>	:CALCulate:APD:TRACe[1] 2:FAIL?
<b>Example</b>	CALC:APD:TRAC:FAIL? returns a zero if there is no failure, 1 if the trace exceeds either the limit.
<b>Initial S/W Revision</b>	A.13.00

### Frequency of Disturbance Level Limit (Remote Command Only)

Defines a list of frequency values for a given disturbance level limit line. Up to 2000 points may be defined for each limit using the following parameters.

<b>Remote Command</b>	:CALCulate:APD:LLINe[1]:DLEVel:CONTRol[:DATA] <x>, <x>, ... :CALCulate:APD:LLINe[1]:DLEVel:CONTRol[:DATA]?
<b>Example</b>	CALC:APD:LLIN:DLEV:CONT 1GHz, 2GHz, 2GHz, 3GHz Describes the X values of a stair-stepped limit line. CALC:APD:LLIN:DLEV:CONT?
Preset	Unaffected by Preset
State Saved	Saved in instrument state.
Initial S/W Revision	A.13.00

<b>Remote Command</b>	:CALCulate:APD:LLINe[1]:DLEVel:CONTRol:POINTs?
<b>Example</b>	CALC:APD:LLIN:DLEV:CONT:POIN? Returns the number of points in the limit line.
Preset	1
State Saved	Saved in instrument state.
Initial S/W Revision	A.13.00

### Frequency of Probability Limit (Remote Command Only)

Defines a list of frequency values for a given probability limit line. Up to 2000 points may be defined for each limit using the following parameters.

<b>Remote Command</b>	:CALCulate:APD:LLINe[1]:PROBability:CONTRol[:DATA] <x>, <x>, ... :CALCulate:APD:LLINe[1]:PROBability:CONTRol[:DATA]?
<b>Example</b>	CALC:APD:LLIN:PROB:CONT 1GHz, 2GHz, 2GHz, 3GHz Describes the X values of a stair-stepped limit line. CALC:APD:LLIN:PROB:CONT?
Preset	Unaffected by Preset
State Saved	Saved in instrument state.
Initial S/W Revision	A.13.00

<b>Remote Command</b>	:CALCulate:APD:LLINe[1]:PROBability:CONTRol:POINTs?
<b>Example</b>	CALC:APD:LLIN:PROB:CONT:POIN? Returns the number of points in the limit line.
Preset	1
State Saved	Saved in instrument state.
Initial S/W Revision	A.13.00

### Disturbance Level- E limit (Remote Command Only, SCPI standard compatibility)

Defines a list of disturbance values for a given limit line. Up to 200 points may be defined for each limit. The limit defined in this SCPI is enabled when APD method is set to Disturbance Level (CALCulate:APD:LLINE [1]:METHOD DLEVEL). The units default to the current amplitude axis unit (X Axis) and the range is -200 dBm to +100 dBm.

The points query returns the number of points in the amplitude list. It will not be possible to turn on the limit line unless the number of points in the control matches the number of points in the amplitude.

The points query returns the number of points in the amplitude list. It should match the number of points in the control, that is, the number of values for the CONTROL axis and for the corresponding limit lines must be identical. If one array is larger than the other, the limit trace is built using only as much data as is contained in the smaller array.

An empty array returns the system error “list is empty” to a data query, 0 to a POINTs query.

<b>Remote Command</b>	:CALCulate:APD:LLINE [1] :DLEVEL [:DATA] <ampl>, <ampl>, ... :CALCulate:APD:LLINE [1] :DLEVEL [:DATA] ?
<b>Example</b>	:CALC:APD:LLIN:DLEV:DATA -10, -10, -20, -20 describes the amplitude values of limit line
<b>Preset</b>	Limit line data is cleared by Restore Mode Defaults.
<b>State Saved</b>	Saved in instrument state.
<b>Initial S/W Revision</b>	A.13.00

<b>Remote Command</b>	:CALCulate:APD:LLINE [1] :DLEVEL :POINTs ?
<b>Example</b>	:CALC:APD:LLIN:DLEV:POIN? returns the number of points in the Disturbance Level limit line.
<b>Preset</b>	Upper Limit line data/points are cleared by Restore Mode Defaults.
<b>State Saved</b>	Saved in instrument state.
<b>Initial S/W Revision</b>	A.13.00

### Probability of Time- ρ limit (Remote Command Only, SCPI standard compatibility)

Defines a list of probability values for a given limit line. Up to 200 points may be defined for each limit. The limit defined in this SCPI is enabled when APD method is set to Probability of Time (CALCulate:APD:LLINE [1]:METHOD PROBABILITY).

The points query returns the number of points in the amplitude list. It will not be possible to turn on the limit line unless the number of points in the control matches the number of points in the amplitude.

The points query returns the number of points in the amplitude list. It should match the number of points in the control, that is, the number of values for the CONTROL axis and for the corresponding limit lines must be identical. If one array is larger than the other, the limit trace is built using only as much data as is contained in the smaller array.



An empty array returns the system error “list is empty” to a data query, 0 to a POINTs query.

<b>Remote Command</b>	:CALCulate:APD:LLINe[1]:PROBability[:DATA] <double>   <double>   ... :CALCulate:APD:LLINe[1]:PROBability[:DATA]?
<b>Example</b>	:CALC:APD:LLIN:PROB:DATA 0.1,0.01 describes the probability values of limit line
Preset	Limit line data is cleared by Restore Mode Defaults.
State Saved	Saved in instrument state.
Initial S/W Revision	A.13.00

<b>Remote Command</b>	:CALCulate:APD:LLINe[1]:PROBability:POINTs?
<b>Example</b>	:CALC:APD:LLIN:PROB:POIN? returns the number of points in the probability limit line.
Preset	Upper Limit line data/points are cleared by Restore Mode Defaults.
State Saved	Saved in instrument state
Initial S/W Revision	A.13.00

## Analog Demod Tune & Listen

The Analog Demod Tune & Listen key opens the Analog Demod menu, which contains keys to turn the demod function on and off and select the modulation type.

Key Path	Meas Setup
<b>Remote Command</b>	[ :SENSe ] :APD:DEMod AM FM PM OFF [ :SENSe ] :APD:DEMod?
<b>Example</b>	APD:DEM AM APD:DEM?
Preset	OFF
State Saved	Saved in instrument state
Range	AM FM PM OFF
Initial S/W Revision	A.13.00

## AM

Pressing this key, when it is not selected, selects and activates the AM demodulation function.

Key Path	Meas Setup, Analog Demod Tune&Listen
<b>Example</b>	APD:DEM AM Turns AM demodulation function ON.
State Saved	Saved in instrument state
Initial S/W Revision	A.13.00

## FM

Pressing this key, when it is not selected, selects and activates the FM demodulation function. Pressing it a second time branches to the FM Demod menu where FM demodulation settings can be adjusted.

Key Path	Meas Setup, Analog Demod Tune&Listen
<b>Example</b>	APD:DEM FM Turns FM demodulation function ON.
State Saved	Saved in instrument state
Initial S/W Revision	A.13.00

## De-emphasis (FM Demod Only)

The De-emphasis setting controls a single-pole filter (6 dB/octave roll off), used to counter intentional pre-emphasis in the transmitter. When the De-emphasis state is OFF the hardware digital filter is bypassed, otherwise the setting is applied.

Key Path	Meas Setup, Analog Demod, FM
<b>Remote Command</b>	[ :SENSe ] :APD:DEMod:FM:DEEMphasis OFF US25 US50 US75 US750 [ :SENSe ] :APD:DEMod:FM:DEEMphasis?
<b>Example</b>	APD:DEM:FM:DEEM US75 APD:DEM:FM:DEEM?
Notes	Only available in FM. Grayed out for AM and PM.
Preset	US75
State Saved	Saved in instrument state
Range	OFF US25 US50 US75 US750
Initial S/W Revision	A.13.00

## Off

This setting bypasses the De-emphasis filter.

Key Path	Meas Setup, Analog Demod Tune&Listen, FM, De-emphasis
<b>Example</b>	APD:DEM:FM:DEEM OFF
Readback	Off
Initial S/W Revision	A.13.00

## 25 $\mu$ s

Sets the De-emphasis time constant to 25 $\mu$ s.

Key Path	Meas Setup, Analog Demod Tune&Listen, FM, De-emphasis
<b>Example</b>	APD:DEM:FM:DEEM US25
Readback	25 ∞s
Initial S/W Revision	A.13.00

50 μs

Sets the De-emphasis time constant to 50 μs.

Key Path	Meas Setup, Analog Demod Tune&Listen, FM, De-emphasis
<b>Example</b>	APD:DEM:FM:DEEM US50
Readback	50 ∞s
Initial S/W Revision	A.13.00

75 μs

Sets the De-emphasis time constant to 75 μs.

Key Path	Meas Setup, Analog Demod Tune&Listen, FM, De-emphasis
<b>Example</b>	APD:DEM:FM:DEEM US75
Readback	75 ∞s
Initial S/W Revision	A.13.00

750 μs

Sets the De-emphasis time constant to 750 μsec.

Key Path	Meas Setup, Analog Demod Tune&Listen, FM, De-emphasis
<b>Example</b>	APD:DEM:FM:DEEM US750
Readback	750 ∞s
Initial S/W Revision	A.13.00

## PM

Pressing this key, when it is not selected, selects and activates the PM demodulation function.

Key Path	Meas Setup, Analog Demod Tune&Listen
<b>Example</b>	APD:DEM PM Turns PM demodulation function ON.
State Saved	Saved in instrument state.
Initial S/W Revision	A.13.00

## Off

Pressing this key, turns the demodulation function off.

Key Path	Meas Setup, Analog Demod Tune&Listen
<b>Example</b>	:APD:DEM OFF Turns off demodulation function.
State Saved	Saved in instrument state.
Initial S/W Revision	A.13.00

## Meas Preset

Returns the measurement local variables in the current measurement to their preset values.

Key Path	Meas Setup
<b>Remote Command</b>	:CONFigure:APD
<b>Example</b>	CONF:APD
Initial S/W Revision	A.13.00

## Mode

See "Mode" on page 222

## Mode Preset

Returns the active mode to a known state.

Mode Preset does the following for the currently active mode:

- Aborts the currently running measurement.
- Brings up the default menu for the mode, with no active function.
- Sets measurement Global settings to their preset values for the active mode only.
- Activates the default measurement.
- Brings up the default menu for the mode.
- Clears the input and output buffers.
- Sets Status Byte to 0.

Mode Preset does not:

- Cause a mode switch
- Affect mode persistent settings
- Affect system settings

See "[How-To Preset](#)" on page 959 for more information.

<b>Key Path</b>	Front-panel key
<b>Remote Command</b>	:SYSTem:PRESet
<b>Example</b>	:SYST:PRES
<b>Notes</b>	*RST is preferred over :SYST:PRES for remote operation. *RST does a Mode Preset, as done by the :SYST:PRES command, and it sets the measurement mode to Single measurement rather than Continuous for optimal remote control throughput. Clears all pending OPC bits. The Status Byte is set to 0.
<b>Couplings</b>	A Mode Preset aborts the currently running measurement, activates the default measurement, and gets the mode to a consistent state with all of the default couplings set.
<b>Backwards Compatibility Notes</b>	In the X-Series, the legacy "Factory Preset" has been replaced with Mode Preset, which only presets the currently active mode, not the entire instrument. In the X-Series, the way to preset the entire instrument is by using System, Restore System Defaults All, which behaves essentially the same way as restore System Defaults does on ESA and PSA. There is also no "Preset Type" as there is on the PSA. There is a green Mode Preset front-panel key that does a Mode Preset and a white-with-green-letters User Preset front-panel key that does a User Preset. The old PRESet:TYPE command is ignored (without generating an error), and SYST:PRES without a parameter does a Mode Preset, which should cover most backward code compatibility issues. The settings and correction data under the Input/Output front-panel key (examples: Input Z Corr, Ext Amp Gain, etc.) are no longer part of any Mode, so they will not be preset by a Mode Preset. They are preset using Restore Input/Output Defaults, Restore System Defaults All. Note that because User Preset does a Recall State, and all of these settings are saved in State, they ARE recalled when using

	User Preset.
Initial S/W Revision	Prior to A.02.00

## How-To Preset

The table below shows all possible presets, their corresponding SCPI commands and front-panel access (key paths). Instrument settings depend on the current measurement context. Some settings are local to the current measurement, some are global (common) across all the measurements in the current mode, and some are global to all the available modes. In a similar way, restoring the settings to their preset state can be done within the different contexts.

Auto Couple - is a measurement local key. It sets all Auto/Man parameter couplings in the measurement to Auto. Any Auto/Man selection that is local to other measurements in the mode will not be affected.

Meas Preset - is a measurement local key. Meas Preset resets all the variables local to the current measurement except the persistent ones.

Mode Preset - resets all the current mode's measurement local and measurement global variables except the persistent ones.

Restore Mode Defaults - resets ALL the Mode variables (and all the Meas global and Meas local variables), including the persistent ones.

Type Of Preset	SCPI Command	Front Panel Access
Auto Couple	:COUPlE ALL	Auto Couple front-panel key
Meas Preset	:CONFIgure:<Measurement>	Meas Setup Menu
Mode Preset	:SYSTem:PRESet	Mode Preset (green key)
Restore Mode Defaults	:INSTrument:DEFault	Mode Setup Menu
Restore All Mode Defaults	:SYSTem:DEFault MODEs	System Menu; Restore System Default Menu
*RST	*RST	not possible (Mode Preset with Single)
Restore Input/Output Defaults	:SYSTem:DEFault INPut	System Menu; Restore System Default Menu
Restore Power On Defaults	:SYSTem:DEFault PON	System Menu; Restore System Default Menu
Restore Alignment Defaults	:SYSTem:DEFault ALIGn	System Menu; Restore System Default Menu
Restore Miscellaneous Defaults	:SYSTem:DEFault MISC	System Menu; Restore System Default Menu
Restore All System Defaults	:SYSTem:DEFault [ALL] :SYSTem:PRESet:PERSistent	System Menu; Restore System Default Menu
User Preset	:SYSTem:PRESet:USER	User Preset Menu
User Preset All Modes	:SYSTem:PRESet:USER:ALL	User Preset Menu

11 APD Measurement  
Mode Preset

Power On Mode Preset	:SYSTem:PON:TYPE MODE	System Menu
Power On User Preset	:SYSTem:PON:TYPE USER	System Menu
Power On Last State	:SYSTem:PON:TYPE LAST	System Menu



## Mode Setup

See ["Mode Setup"](#) on page 246

## Peak Search

Pressing Peak Search will place the selected marker at the peak amplitude value that is on screen.

Key Path	Front-panel key
<b>Remote Command</b>	:CALCulate:APD:MARKer[1] 2 ... 12:MAXimum
<b>Example</b>	CALC:APD:MARK2:MAX Performs a peak search using marker 2. CALC:APD:MARK2:Y? Queries the probability of time (Y-axis) value for marker 2. CALC:APD:MARK2:X? Queries the amplitude (X-axis) value for marker 2. SYST:ERR? Queries the errors to determine if a peak is found. The error -200 will be returned after an unsuccessful search.
Notes	Sending this command selects the subopcoded marker.
Initial S/W Revision	A.13.00

Print

See "Print" on page 271

## Quick Save

The Quick Save front-panel key repeats the most recent save that was performed from the Save menu, with the following exceptions:

- Register saves are not remembered as Saves for the purpose of the Quick Save function
- If the current measurement does not support the last non-register save that was performed, an informational message is generated, “File type not supported for this measurement”

Quick Save repeats the last type of qualified save (that is, a save qualified by the above criteria) in the last save directory by creating a unique filename using the Auto File Naming algorithm described below.

If Quick Save is pressed after startup and before any qualified Save has been performed, the Quick Save function performs a Screen Image save using the current settings for Screen Image saves (current theme, current directory), which then becomes the “last save” for the purpose of subsequent Quick Saves.

The Auto File Naming feature automatically generates a file name for use when saving a file. The filename consists of a prefix and suffix separated by a dot, as is standard for the Windows® file system. A default prefix exists for each of the available file types:

Type	Default Prefix	Menu
State	State_	(Save/Recall)
Trace + State	State_	(Save/Recall)
Screen	Screen_	(Save/Recall)
Amplitude Corrections	Ampcor_	(Import/Export)
Traces	Trace_	(Import/Export)
Limit Lines	LLine_	(Import/Export)
Measurement Result	MeasR_	(Import/Export)
Capture Buffer	CapBuf_	(Import/Export)

A four digit number is appended to the prefix to create a unique file name. The numbering sequence starts at 0000 within each Mode for each file type and updates incrementally to 9999, then wraps to 0000 again. It remembers where it was through a Mode Preset and when leaving and returning to the Mode. It is reset by Restore Misc Defaults and Restore System Defaults and subsequent running of the instrument application. So, for example, the first auto file name generated for State files is State\_0000.state. The next is State\_0001, and so forth.

One of the key features of Auto File Name is that we guarantee that the Auto File Name will never conflict with an existing file. The algorithm looks for the next available number. If it gets to 9999, then it looks for holes. If it find no holes, that is no more numbers are available, it gives an error.

For example, if when we get to State\_0010.state there is already a State\_0010.state file in the current directory, it advances the counter to State\_0011.state to ensure that no conflict will exist (and then it verifies that State\_0011.state also does not exist in the current directory and advances again if it does, and so forth).

If you enter a file name for a given file type, then the prefix becomes the filename you entered instead of the default prefix, followed by an underscore. The last four letters (the suffix) are the 4-digit number.

For example, if you save a measurement results file as “fred.csv”, then the next auto file name chosen for a measurement results save will be fred\_0000.csv.

**NOTE**

Although 0000 is used in the example above, the number that is used is actually the current number in the Meas Results sequence, that is, the number that would have been used if you had not entered your own file name.

---

**NOTE**

If the filename you entered ends with \_dddd, where d=any number, making it look just like an auto file name, then the next auto file name picks up where you left off with the suffix being dddd + 1.

---

Key Path	Front-panel key
Notes	No remote command for this key specifically.
Initial S/W Revision	Prior to A.02.00

---

## Recall

The recall key accesses the menu that allows you to load a measurement state and data from external files or registers.

Key Path	Front-panel key
Initial S/W Revision	A.07.00

### State

The Recall State menu lets you choose a register or file from which to recall the state.

The content of a state file includes all of the settings and data required to return the analyzer as closely as possible to the Mode it was in, with the exact settings that were in place, when the save occurred. The Mode settings in each state file include the settings that are affected by Mode Preset, as well as the additional settings affected by Restore Mode Defaults; all of the Mode's settings. In addition, all of the settings of the Input/Output system are included, even though they are outside of the Mode's state, because they are needed to restore the complete setup. Persistent System settings (for example, GPIB address) are not affected by either a Mode Preset or Restore Mode Defaults, nor are they included in a saved State file.

Since each state file is only for one Mode, the settings for other Modes are unaffected when it is loaded. Recall State will cause a mode switch if the state being recalled is not from the current active mode.

After the recall completes, the message "File <filename> recalled" or "Recalled State Register <register number>" is displayed.

For rapid recalls, the State menu lists 16 registers that you can choose from to recall. Pressing a Register key initiates the recall. You can also select a file from which to recall.

The default path for all State Files is:

My Documents\<<mode name>\state

where <mode name> is the parameter used to select the mode with the INST:SEL command (for example, SA for the Spectrum Analyzer).

See "[More Information](#)" on page 967.

Key Path	Recall
Mode	All
<b>Remote Command</b>	:MMEMory:LOAD:STATe <filename>
<b>Example</b>	:MMEM:LOAD:STAT "myState.state" This recalls the file myState.state on the default path
<b>Example</b>	MMEM:LOAD:STAT "MyStateFile.state" This loads the state file data (on the default file directory path) into the instrument state.
Notes	When you pick a file to recall, the analyzer first verifies that the file is recallable in the current instrument by checking the software version and model number of the instrument. If everything

matches, a full recall proceeds by aborting the currently running measurement, clearing any pending operations, and then loading the State from the saved state file. You can open state files from any mode, so recalling a State file switches to the mode that was active when the save occurred. After switching to the mode of the saved state file, mode settings and data (if any for the mode) are loaded with values from the saved file. The saved measurement of the mode becomes the newly active measurement and the data relevant to the measurement (if there is any) is recalled.

If there is a mismatch between file version or model number or instrument version or model number, the recall function tries to recall as much as possible and returns a warning message. It may limit settings that differ based on model number, licensing or version number.

After recalling the state, the Recall State function does the following:

- Makes the saved measurement for the mode the active measurement.
- Clears the input and output buffers.
- Status Byte is set to 0.
- Executes a \*CLS

If the file specified is empty an error is generated. If the specified file does not exist, another error is generated. If there is a mismatch between the file and the proper file type, an error is generated. If there is a mismatch between file version or model number or instrument version or model number, a warning is displayed. Then it returns to the State menu and File Open dialog goes away.

After the Recall, the analyzer exits the Recall menu and returns to the previous menu.

<b>Backwards Compatibility SCPI</b>	:MMEMory:LOAD:STATe 1,<filename>
Initial S/W Revision	Prior to A.02.00

For backwards compatibility, the above syntax is supported. The "1" is simply ignored.

## More Information

In measurements that support saving Traces, for example, Swept SA, the Trace data is saved along with the State in the State file. When recalling the State, the Trace data is recalled as well. Traces are recalled exactly as they were stored, including the writing mode and update and display modes. If a Trace was updating and visible when the State was saved, it will come back updating and visible, and its data will be rewritten right away. When you use State to save and recall traces, any trace whose data must be preserved should be placed in View or Blank mode before saving.

The following table describes the Trace Save and Recall possibilities:

You want to recall state and one trace's data, leaving other traces unaffected.	Save Trace+State from 1 trace. Make sure that no other traces are updating (they should all be in View or Blank mode) when the save is performed.	On Recall, specify the trace you want to load the one trace's data into. This trace will load in View. All other traces' data will be unaffected, although their trace mode will be as it was when the state save was performed.
You want to recall all traces	Save Trace+State from ALL traces.	On Recall, all traces will come back in View (or Blank if they were in Blank or Background when saved)

You want all traces to load exactly as they were when saved.

Save State

On recall, all traces' mode and data will be exactly as they were when saved. Any traces that were updating will have their data immediately overwritten.

### From File...

When you press “From File”, the analyzer brings up a Windows dialog and a menu entitled “File Open.” This menu allows you to navigate to the various fields in the Windows dialog without using a keyboard or mouse. The Tab and Arrow keys can also be used for dialog navigation.

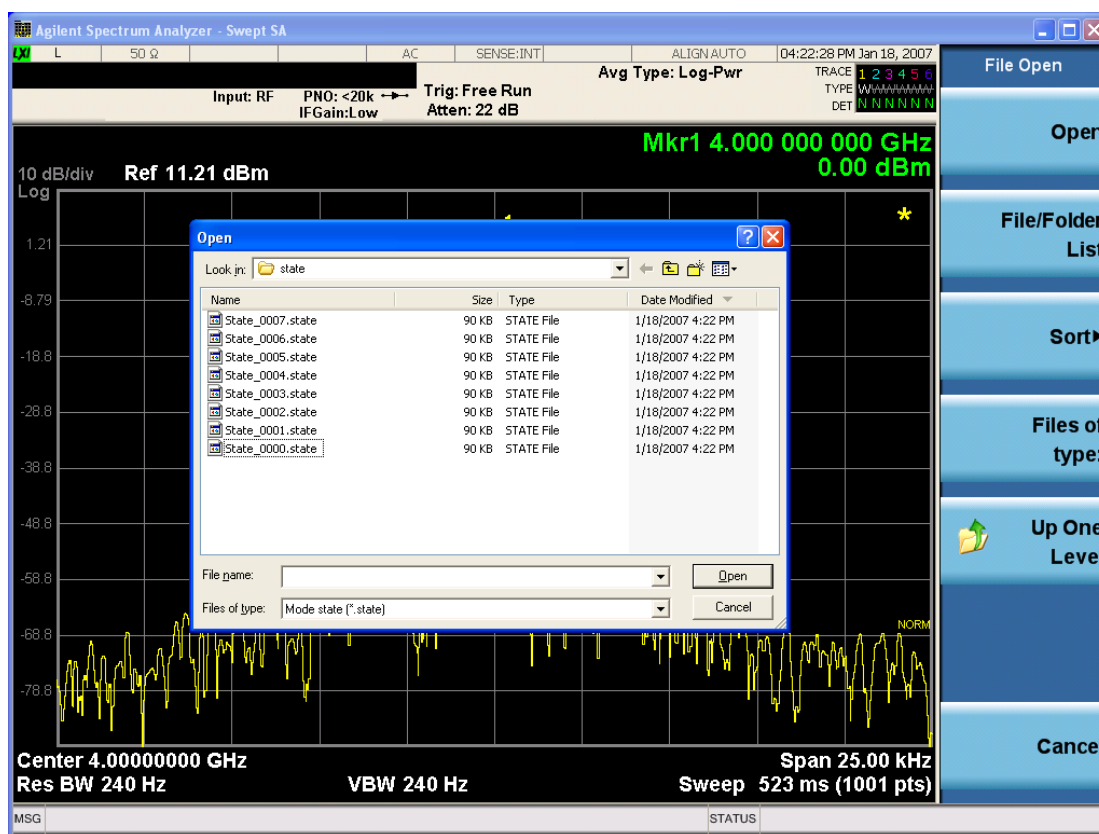

Listed below are the functions of the various fields in the dialog, and the corresponding softkeys:

#### Open

Performs the recall of the specified file. While the recall is being performed, the floppy icon appears briefly in the Meas bar.

#### File/Folder List

Enables you to navigate to the center of the dialog that contains the list of files and folders. Once here you can get information about the file and use the tab keys to navigate to the other fields in the dialog, such as Look In.



## Look In

The Look In field shows the path from which the file will be recalled and allows you to change the path using the up and down arrow keys to navigate to other paths; the Enter key to open a directory; and the Backspace key to go back one directory. The **Look In field** first uses the last path from the Save As dialog **Save In**: path for that same file type. There is no softkey for directly navigating to the Look In field, but you can use the left tab to get here from the File/Folder List.

User specified paths are remembered when you leave and return to a Mode and are reset back to the default using Restore Mode Defaults.

## Sort

Accesses a menu that enables you to sort the files within the File Open dialog. Only one sorting type can be selected at a time and the sorting happens immediately. The sorting types are By Date, By Name, By extension, and By Size.

## Files of Type

This field shows the file suffix for the type of file you have selected to recall. For example, if you navigated here while recalling State, "Mode state (\*.state)" is in the field. If you navigated here while recalling Trace, ""Mode state (\*.trace)" is in the field. If you navigated here while importing a trace data file, "Trace Data (\*.csv)" is in the field. For some file types, there is more than one choice in the dropdown menu, which you can select by using the up and down arrow keys and Enter.

## Up One Level

This key corresponds to the icon of a folder with the up arrow that is in the tool bar of the dialog. When pressed, it causes the file and folder list to navigate up one level in the directory structure. The Backspace key does the same thing.

## Cancel

This key corresponds to the Cancel selection in the dialog. It causes the current **Open** request to be cancelled. The ESC key does the same thing.

Key Path	Recall, State
Notes	Brings up the Open dialog for recalling a State Save Type
Initial S/W Revision	Prior to A.02.00

## Edit Register Names

You may enter a custom name on any of the Register keys, to help you remember what you are using that state to save. To do this, press the Edit Register Names key, choose the register whose name you wish to edit, and then enter the desired label using the Alpha Editor or an external PC keyboard.

The maximum number of characters that can be added is 30. In most cases, 30 characters will fit on two lines of the key.

For more information and the SCPI command, see Edit Register Names under the Save, State function.

Key Path	Recall, State
Mode	All
Dependencies	N9060A-7FP or N9060B-2FP license required to edit the register names. When the feature is not licensed, sending the SCPI command generates an error, -221, "Settings conflict;Option not available"
Initial S/W Revision	A.11.00

### Register 1 thru Register 16

Selecting any one of these register keys causes the State of the mode from the specified Register to be recalled. Each of the register keys annotates whether it is empty or at what date and time it was last modified. In addition, you can use the Edit Register Names key under Save, State to enter custom names for each register.

Registers are shared by all modes, so recalling from any one of the registers will cause a mode switch to the mode that was active when the save to the Register occurred.

Although these 16 registers are the only registers available from the front panel, there are 128 state registers available in the instrument. Registers 17-128 are only available from the SCPI interface, using the \*RCL command.

After the recall completes, the message "Register <register number> recalled" appears in the message bar. If you are in the Spectrum Analyzer Mode, and you are recalling a register that was saved in the Spectrum Analyzer Mode, then after the recall, you will still be in the Recall Register menu. If the Recall causes you to switch modes, then after the Recall, you will be in the Frequency menu.

If a requested register is empty an error is generated.

Key Path	Recall, State
<b>Example</b>	*RCL 1
Range	1-16 from front panel, 1-128 from SCPI
Readback	Date and time with seconds resolution are displayed on the key OR A custom name of up to 30 characters entered using the Save, State, Edit Register Names key OR “(empty)” if no prior save operation has been performed to this register.
Initial S/W Revision	Prior to A.02.00
Modified at S/W Revision	Prior to A.11.00

### Register 1 thru Register 16

Selecting any one of these register keys causes the State of the mode from the specified Register to be recalled. Each of the register keys annotates whether it is empty or at what date and time it was last

modified. In addition, you can use the Edit Register Names key under Save, State to enter custom names for each register.

Registers are shared by all modes, so recalling from any one of the registers will cause a mode switch to the mode that was active when the save to the Register occurred.

Although these 16 registers are the only registers available from the front panel, there are 128 state registers available in the instrument. Registers 17–128 are only available from the SCPI interface, using the \*RCL command.

After the recall completes, the message "Register <register number> recalled" appears in the message bar. If you are in the Spectrum Analyzer Mode, and you are recalling a register that was saved in the Spectrum Analyzer Mode, then after the recall, you will still be in the Recall Register menu. If the Recall causes you to switch modes, then after the Recall, you will be in the Frequency menu.

If a requested register is empty an error is generated.

Key Path	Recall, State
<b>Example</b>	*RCL 1
Range	1–16 from front panel, 1–128 from SCPI
Readback	Date and time with seconds resolution are displayed on the key OR A custom name of up to 30 characters entered using the Save, State, Edit Register Names key OR “(empty)” if no prior save operation has been performed to this register.
Initial S/W Revision	Prior to A.02.00
Modified at S/W Revision	Prior to A.11.00

## Data (Import)

Importing a data file loads data that was previously saved from the current measurement or from other measurements and/or modes that produce compatible data files. The Import Menu only contains Data Types that are supported by the current measurement.

Since the commonly exported data files are in .csv format, the data can be edited by the user prior to importing. This allows you to export a data file, manipulate the data in Excel (the most common PC Application for manipulating .csv files) and then import it.

Importing Data loads measurement data from the specified file into the specified or default destination, depending on the data type selected. Selecting an Import Data menu key will not actually cause the importing to occur, since the analyzer still needs to know from where to get the data. Pressing the Open key in this menu brings up the Open dialog and Open menu that provides you with the options from where to recall the data. Once a filename has been selected or entered in the Open menu, the recall occurs as soon as the Open button is pressed.

Key Path	Recall
Mode	All

Notes	The menu is built from whatever data types are available for the mode. Some keys will be missing completely, so the key locations in the sub-menu will vary. No SCPI command directly controls the Data Type that this key controls. The Data Type is included in the MMEM:LOAD commands.
Dependencies	If a file type is not used by a certain measurement, it is grayed out for that measurement. The key for a file type will not show at all if there are no measurements in the Mode that support it.
Preset	Is not affected by Preset or shutdown, but is reset during Restore Mode Defaults
Readback	The data type that is currently selected
Initial S/W Revision	Prior to A.02.00

## Amplitude Correction

This key selects the Amplitude Corrections as the data type to be imported. When pressed a second time, it brings up the Select Menu, which lets you select the Correction into which the data will be imported.

Amplitude Corrections are fully discussed in the documentation of the Input/Output key, under the Corrections key.

A set of preloaded Corrections files can be found in the directory

/My Documents/ EMC Limits and Ampcor.

When the Amplitude Correction is an Antenna correction and the Antenna Unit in the file is not None, the Y Axis Unit setting will change to match the Antenna Unit in the file.

Key Path	Recall
Mode	SA EDGE GSM PN
Remote Command	:MMEMory:LOAD:CORRection 1 2 3 4 5 6 7 8, <filename>
Example	:MMEM:LOAD:CORR 2, "myAmpcor.csv" recalls the Amplitude Correction data from the file myAmpcor.csv in the current directory to the 2nd Amplitude Correction table, and turns on Correction 2. The default path is D:\User_My_Documents\Instrument\My Documents\amplitudeCorrections\
Dependencies	Only the first correction array (Correction 1) supports antenna units. This means that a correction file with an Antenna Unit can only be loaded into the Corrections 1 register. Consequently only for Correction 1 does the dropdown in the Recall dialog include.ant, and if an attempt is made to load a correction file into any other Correction register which DOES contain an antenna unit, a Mass Storage error is generated. Corrections are not supported by all Measurements. If in a Mode in which some Measurements support it, this key will be grayed out in measurements that do not. The key will not show at all if no measurements in the Mode support it. Errors are reported if the file is empty or missing, or if the file type does not match, or if there is a mismatch between the file type and the destination data type. If any of these occur during manual operation, the analyzer returns to the Import Data menu and the File Open dialog goes away. This key does not appear unless you have the proper option installed in your instrument. This command will generate an "Option not available" error unless you have the proper option installed in your instrument.

Couplings	When a correction file is loaded from mass storage, it is automatically turned on ( <b>Correction ON</b> ) and <b>ApplyCorrections</b> is set to On. This allows you to see its effect, thus confirming the load.
Readback	selected Correction
<b>Backwards Compatibility SCPI</b>	:MMEMory:LOAD:CORRection ANTenna   CABLe   OTHer   USER, <filename> For backwards compatibility, ANTenna maps to 1, CABLe maps to 2, OTHer maps to 3 and USER maps to 4
Initial S/W Revision	A.02.00

## Default Directory

Specifies the default directory used for loading of Amplitude Correction. If user is selected, the default recall directory is the default (My Documents\amplitudeCorrections) or the last directory you saved the amplitude correction data to. Otherwise, the default recall directory is My Documents\EMC Limits and Ampcor\Ampcor, which contains a set of preloaded amplitude correction files in the directory called Ampcor.

Key Path	Recall, Export Data, Amplitude Correction
<b>Remote Command</b>	:MMEMory:LOAD:CORRection:DDIRectory USER PRELoaded
<b>Example</b>	:MMEM:LOAD:CORR:DDIR USER Select user :MMEM:LOAD:CORR:DDIR?
Notes	USER = User PRELoaded = Preloaded
Preset	PRELoaded
State Saved	Saved in instrument state.
Range	User  Preloaded
Readback	"User"  "Preloaded"
Initial S/W Revision	A.13.00

## Trace

This key selects Trace as the data type to be imported. When pressed a second time, it brings up the Trace Menu, which lets you select the Trace into which the data will be imported.

Key Path	Recall, Data
<b>Remote Command</b>	:MMEMory:LOAD:ATRACE MEAS MEAS2,<filename>
<b>Example</b>	:MMEM:LOAD:ATR MEAS2, "myTrace2.csv" imports the Measured 2 Trace from the file myTrace2.csv in the current path. The default path is My Documents\EMI\data\APD\Traces.
Dependencies	A trace cannot be recalled from a trace file that was exported with ALL traces selected. A trace cannot be imported if the number of trace points in the file does not match the number of

	<p>sweep points currently set for the measurement. If this happens, an error message is generated. Errors are reported if the file is empty or missing, or if the file type does not match, or if there is a mismatch between the file type and the destination data type.</p> <p>If any error occurs while trying to load a file manually (as opposed to during remote operation), the analyzer returns to the Import Data menu and the File Open dialog goes away.</p>
Couplings	When a trace is imported, Trace Update is always turned OFF for that trace and Trace Display is always turned ON.
Readback	Selected Trace
Status Bits/OPC dependencies	Sequential - waits for previous measurement to complete
Initial S/W Revision	A.13.00

## Limit

This key selects Limit Lines as the data type to be imported. When pressed a second time, it brings up the Limits Menu, which enables you to select into which Limit the data will be imported. However, currently there is only 1 limit line for the APD measurement.

Key Path	Recall, Data
Remote Command	:MMEMory:LOAD:ALIMit LLINE1,<filename>
Example	:MMEM:LOAD:LIM LLINE1, "myLimitLine2.csv" imports the Limit Line 1 from the file myLimitLine2.csv in the current path. The default path is My Documents\EMI\data\APD\Limits.
Dependencies	<p>Errors are reported if the file is empty or missing, or if the file type does not match, or if there is a mismatch between the file type and the destination data type. If any of these occur during manual operation, the analyzer returns to the Import Data menu and the File Open dialog goes away.</p> <p>This key will only appear if you have the proper option installed in your instrument.</p>
Couplings	When a limit line is loaded from mass storage, it is automatically turned on. This allows you to see it, thus confirming the load. The Margin settings will match those set when the limit was saved
Readback	Selected Limit Line
Status Bits/OPC dependencies	Sequential - aborts the current measurement
Initial S/W Revision	A.13.00

## Default Directory

Specifies the default directory used for loading of Limit. If user is selected, the default recall directory is the default (My Documents\EMI\data\xxx\Limits where xxx is the measurement name) or the last directory you saved the limit line data to. Otherwise, the default recall directory is My Documents\EMC Limits and Ampcor\Limits, which contains a set of preloaded limit files.

Key Path	Recall, Export Data, Limit
----------	----------------------------

<b>Remote Command</b>	:MMEMory:LOAD:LIMit:DDIRectory USER PRELoaded
<b>Example</b>	:MMEM:LOAD:LIM:DDIR USER Select user :MMEM:LOAD:LIM:DDIR?
Notes	USER = User PRELoaded = Preloaded
Preset	PRELoaded
State Saved	Saved in instrument state.
Range	User  Preloaded
Readback	"User"  "Preloaded"
Initial S/W Revision	A.13.00

## Signal List

This key selects Signal List as the data type to be imported. The next step is to select the Open key in the Import Data menu. Importing a Signal List always replaces the data with the data that is already in the signal list.

Key Path	Recall, Data
<b>Remote Command</b>	:MMEMory:LOAD:ALISt <filename>
<b>Example</b>	MMEM:LOAD:ALIS "myAPDSignalList2.csv" imports the Signal List from the file myAPDSignalList2.csv in the current path. The default path is My Documents\EMI\data\APD\SignalList.
Notes	If the file is empty, error -250.3005 is reported. If the file does not exist error -256 is reported. If there is a mismatch between the file and the destination data type, an error is reported. -250.3003. Then you are returned to the Import Data menu and the File Open dialog goes away.
Status Bits/OPC dependencies	Sequential - aborts the current measurement
Initial S/W Revision	A.13.00

## Open...

When you press "Open", the analyzer brings up a Windows dialog and a menu entitled "File Open." This menu allows you to navigate to the various fields in the Windows dialog without using a keyboard or mouse. The Tab and Arrow keys can also be used for dialog navigation.

See "[From File...](#)" on page 1083 in Recall, State, for a full description of this dialog and menu.

Key Path	Recall, Data
Notes	The key location is mode-dependent and will vary. Brings up Open dialog for recalling a <mode specific> Save Type
Initial S/W Revision	Prior to A.02.00

## State

Most of the functions under this key work the same way in many measurements, so they are documented in the Utility Functions section. For details about this key, see ["State" on page 1081](#).

## Data (Import)

Most of the functions under this key work the same way in many measurements, so they are documented in the Utility Functions section. For details about this key, see ["Data \(Import\)" on page 1086](#).

## Amplitude Correction

Most of the functions under this key work the same way in many measurements. For details about this key, see ["Amplitude Correction " on page 1087](#).

## Default Directory

Specifies the default directory used for loading of Amplitude Correction. If user is selected, the default recall directory is the default (My Documents\amplitudeCorrections) or the last directory you saved the amplitude correction data to. Otherwise, the default recall directory is My Documents\EMC Limits and Ampcor\Ampcor, which contains a set of preloaded amplitude correction files in the directory called Ampcor.

Key Path	Recall, Export Data, Amplitude Correction
Remote Command	:MMEMory:LOAD:CORRection:DDIRectory USER PRELoaded
Example	:MMEM:LOAD:CORR:DDIR USER Select user :MMEM:LOAD:CORR:DDIR?
Notes	USER = User PRELoaded = Preloaded
Preset	PRELoaded
State Saved	Saved in instrument state.
Range	User  Preloaded
Readback	"User"  "Preloaded"
Initial S/W Revision	A.13.00

## Trace

This key selects Trace as the data type to be imported. When pressed a second time, it brings up the Trace Menu, which lets you select the Trace into which the data will be imported.

The trace file contains "meta" data which describes the state of the analyzer when the trace was exported (see ). If the meta data in the file does not match the current SA state, the "invalid data indicator" (\*) is displayed.

Key Path	Recall, Data
Remote Command	:MMEMory:LOAD:TRACe:DATA TRACE1 TRACE2 TRACE3,<filename>



<b>Example</b>	:MMEM:LOAD:TRAC DATA TRACE2, "myTrace2.csv" imports the 2nd trace from the file myTrace2.csv in the current path. The default path is My Documents\EMI\data\xxx\traces where xxx is the measurement name.
<b>Dependencies</b>	A trace cannot be recalled from a trace file that was exported with ALL traces selected. A trace cannot be imported if the number of trace points in the file do not match the number of sweep points currently set for the measurement. If this happens, an error message is generated. Errors are reported if the file is empty or missing, or if the file type does not match, or if there is a mismatch between the file type and the destination data type. If any error occurs while trying to load a file manually (as opposed to during remote operation), the analyzer returns to the Import Data menu and the File Open dialog goes away.
<b>Couplings</b>	When a trace is imported, <b>Trace Update</b> is always turned OFF for that trace and <b>Trace Display</b> is always turned ON.
<b>Readback</b>	1 2 3
<b>Status Bits/OPC dependencies</b>	Sequential - aborts the current measurement.
<b>Initial S/W Revision</b>	Prior to A.02.00

## Limit

This key selects Limit Lines as the data type to be imported. When pressed a second time, it brings up the Limits Menu, which lets you select into which Limit the data will be imported.

<b>Key Path</b>	Recall, Data
<b>Remote Command</b>	:MMEMory:LOAD:LIMit LLINE1   LLINE2   LLINE3   LLINE4   LLINE5   LLINE6,<filename>
<b>Example</b>	:MMEM:LOAD:LIM LLINE2, "myLimitLine2.csv" imports the 2nd Limit Line from the file myLimitLine2.csv in the current path. The default path is depending on the Limit Default Directory selection.
<b>Dependencies</b>	Errors are reported if the file is empty or missing, or if the file type does not match, or if there is a mismatch between the file type and the destination data type. If any of these occur during manual operation, the analyzer returns to the Import Data menu and the File Open dialog goes away. This key will only appear if you have the proper option installed in your instrument.
<b>Couplings</b>	When a limit line is loaded from mass storage, it is automatically turned on. This allows you to see it, thus confirming the load. The Margin settings will match those set when the limit was saved
<b>Readback</b>	1 2 3 4 5 6
<b>Status Bits/OPC dependencies</b>	Sequential - aborts the current measurement
<b>Initial S/W Revision</b>	A.02.00

## Default Directory

Specifies the default directory used for loading of Limit. If user is selected, the default recall directory is the default (My Documents\EMI\data\xxx\Limits where xxx is the measurement name) or the last directory you

saved the limit line data to. Otherwise, the default recall directory is My Documents\EMC Limits and Ampcor\Limits, which contains a set of preloaded limit files.

Key Path	Recall, Export Data, Limit
Remote Command	:MMEMory:LOAD:LIMit:DDIRectory USER PRELoaded
Example	:MMEM:LOAD:LIM:DDIR USER Select user :MMEM:LOAD:LIM:DDIR?
Notes	USER = User PRELoaded = Preloaded
Preset	PRELoaded
State Saved	Saved in instrument state.
Range	User Preloaded
Readback	"User"  "Preloaded"
Initial S/W Revision	A.13.00

## Open

Most of the functions under this key work the same way in many measurements. For details about this key, see ["Open..." on page 1089](#).

## Restart

The Restart function restarts the current sweep, or measurement, or set of averaged/held sweeps or measurements. If you are Paused, pressing Restart does a Resume.

The Restart function is accessed in several ways:

- Pressing the Restart key
- Sending the remote command INIT:IMMEDIATE
- Sending the remote command INIT:RESTART

See "[More Information](#)" on page 979

Key Path	Front-panel key
Remote Command	:INITiate[:IMMEDIATE] :INITiate:RESTART
Example	:INIT:IMM :INIT:REST
Notes	:INITiate:RESTART and :INITiate:IMMEDIATE perform exactly the same function.
Couplings	Resets average/hold count k. For the first sweep overwrites all active (update=on) traces with new current data. For application modes, it resets other parameters as required by the measurement.
Status Bits/OPC dependencies	This is an Overlapped command. The STATUS:OPERation register bits 0 through 8 are cleared. The STATUS:QUESTIONable register bit 9 (INTEgrity sum) is cleared. The SWEEPING bit is set. The MEASURING bit is set.
Backwards Compatibility Notes	For Spectrum Analysis mode in ESA and PSA, the Restart hardkey and the INITiate:RESTART command restart trace averages (displayed average count reset to 1) for a trace in Clear Write, but did not restart Max Hold and Min Hold. In the X-Series, the Restart hardkey and the INITiate:RESTART command restart not only Trace Average, but MaxHold and MinHold traces as well. For wireless comms modes in ESA and PSA, the Restart hardkey and the INITiate:RESTART command restart every measurement, which includes all traces and numeric results. There is no change to this operation.
Initial S/W Revision	Prior to A.02.00

### More Information

The **Restart** function first aborts the current sweep/measurement as quickly as possible. It then resets the sweep and trigger systems, sets up the measurement and initiates a new data measurement sequence with a new data acquisition (sweep) taken once the trigger condition is met.

If the analyzer is in the process of aligning when **Restart** is executed, the alignment finishes before the restart function is performed.

Even when set for Single operation, multiple sweeps may be taken when Restart is pressed (for example, when averaging/holding is on). Thus when we say that **Restart** "restarts a measurement," we may mean:

- It restarts the current sweep
- It restarts the current measurement
- It restarts the current set of sweeps if any trace is in Trace Average, Max Hold or Min Hold
- It restarts the current set of measurements if Averaging, or Max Hold, or Min Hold is on for the measurement
- depending on the current settings.

With **Average/Hold Number** (in **Meas Setup** menu) set to 1, or Averaging off, or no trace in Trace Average or Hold, a single sweep is equivalent to a single measurement. A single sweep is taken after the trigger condition is met; and the analyzer stops sweeping once that sweep has completed. However, with **Average/Hold Number** >1 and at least one trace set to **Trace Average, Max Hold, or Min Hold (SA Measurement)** or **Averaging on (most other measurements)**, multiple sweeps/data acquisitions are taken for a single measurement. The trigger condition must be met prior to each sweep. The sweep is stopped when the average count  $k$  equals the number  $N$  set for **Average/Hold Number**. A measurement average usually applies to all traces, marker results, and numeric results; but sometimes it only applies to the numeric results.

Once the full set of sweeps has been taken, the analyzer will go to idle state. To take one more sweep without resetting the average count, increment the average count by 1, by pressing the step up key while **Average/Hold Number** is the active function, or sending the remote command `CALC:AVER:TCON UP`.

## Save

The Save menu lets you choose what you want to save and where you want to save it. Among the types of files you can save are **States**, **Traces**, and **Screen Images**. In addition, an Export (Data) option lets you save a number of data types as CSV files for easy import into Excel and other spreadsheet programs.

Key Path	Front-panel key
Mode	All
Notes	No remote command for this key specifically, but the :MMEM:STORe command is available for specific file types. An example is :MMEM:STOR:STATe <filename>.
Initial S/W Revision	Prior to A.02.00

## State

The Save State menu lets you choose a register or file for saving the state.

The content of a state file includes all of the settings and data required to return the analyzer as closely as possible to the Mode it was in, with the exact settings which were in place, when the save occurred. The Mode settings in each state file include the settings that are affected by Mode Preset, as well as the additional settings affected by Restore Mode Defaults; all of the Mode's settings. In addition, all of the settings of the Input/Output system are included, even though they are outside of the Mode's state, because they are needed to restore the complete setup. Persistent System settings (for example, Verbose SCPI) are not affected by either Mode Preset or Restore Mode Defaults, nor are they included in a saved State file.

After the save completes, the message "File <filename> saved" or "State Register <register number> saved" is displayed.

For rapid saving, the State menu lists 16 registers to save to. Pressing a Register key initiates the save. You can also select a file to save to.

The default path for all State Files is:

My Documents\<>mode name>\state

where <mode name> is the parameter used to select the mode with the INST:SEL command (for example, SA for the Spectrum Analyzer).

Key Path	Save
Mode	All
Remote Command	:MMEMory:STORe:STATe <filename>
Example	MMEM:STOR:STATe "MyStateFile.state" This stores the current instrument state data in the file MyStateFile.state in the default directory.
Notes	Both single and double quotes are supported for any filename parameter over remote. After saving to a register, that register's menu key is updated with the date the time, unless a custom label has been entered for that key. After saving to a register, you remain in the Save State menu, so that you can see the Register key

update. After saving to a file, the analyzer automatically returns to the previous menu and any Save As dialog goes away.

**Backwards Compatibility SCPI** :MMEMory:STORe:STATe 1,<filename>

For backwards compatibility, the above syntax is supported. The "1" is simply ignored. The command is sequential.

Initial S/W Revision Prior to A.02.00

### To File . . .

When you press “To File”, the analyzer brings up a Windows dialog and a menu entitled “Save As.” This menu allows you to navigate to the various fields in the Windows dialog without using a keyboard or mouse. The Tab and Arrow keys can also be used for dialog navigation.

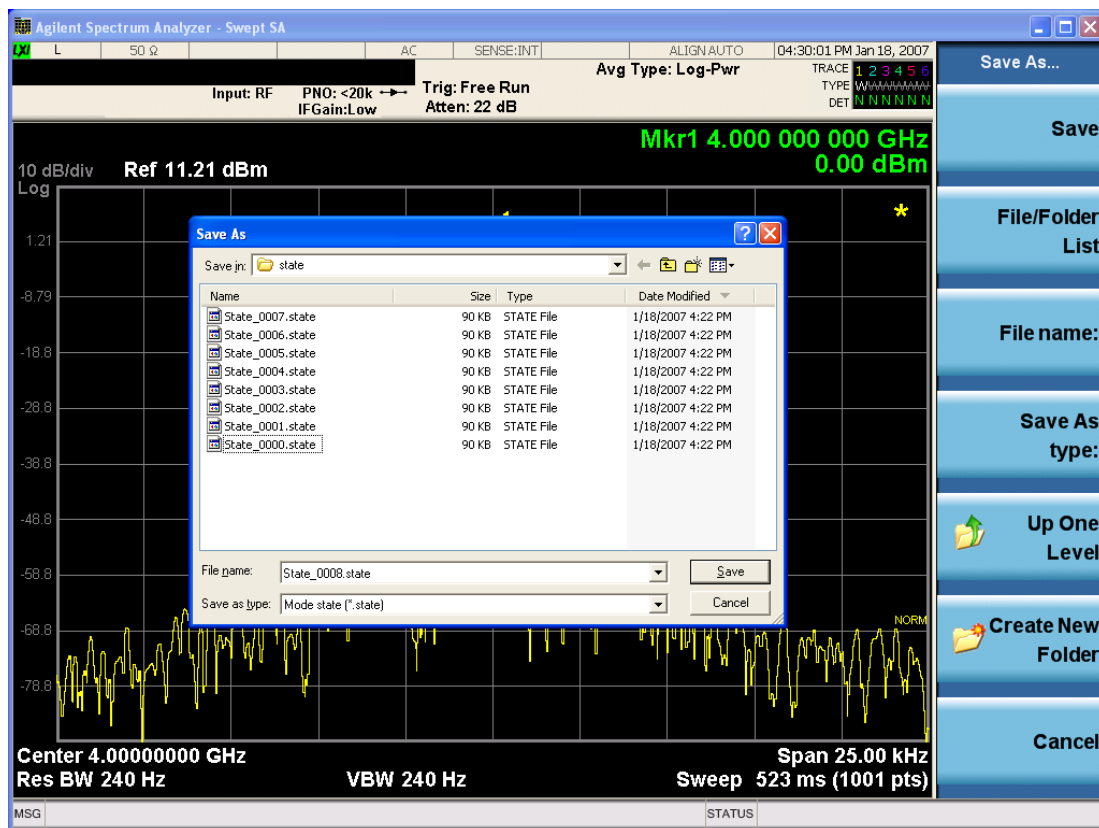

The Listed below

are the functions of the various fields in the dialog, and the corresponding softkeys:

#### Save

Performs the save to the specified file of the selected type. If the file already exists, a dialog will appear that allows you to replace the existing file by selecting OK, or you can Cancel the request. If you select OK, the file will be overwritten. Using the C: drive is strongly discouraged, since it runs the risk of being overwritten during an instrument software upgrade.

While the save is being performed, the floppy icon appears briefly in the Meas bar.

## File/Folder List

Enables you to navigate to the center of the dialog that contains the list of files and folders. Once here you can get information about the file and use the tab keys to navigate to the other fields in the dialog, such as Save In.

## Save In

The Save In field shows the path to which the file will be saved and allows you to change the path using the up and down arrow keys to navigate to other paths; the Enter key to open a directory; and the Backspace key to go back one directory. The **Save In field** defaults to the default path for this type of file and remembers the last path you used to save this type of file. There is no softkey for directly navigating to the Save In field but you can use left tab to get here from the File/Folder List.

User specified paths are remembered when you leave and return to a Mode and are reset back to the default using Restore Mode Defaults.

## File Name

The File Name field is initially loaded with an automatically generated filename specific to the appropriate Save Type. The automatically generated filename is guaranteed not to conflict with any filename currently in the directory. You may replace or modify this filename using the File Name key. See the ["Quick Save " on page 1079](#) documentation for more on the automatic file naming algorithm.

When you press the File Name key the analyzer displays the Alpha Editor. Use the knob to choose the letter to add and the front-panel Enter key to add the letter to the file name. The BK character moves you back and the FW character moves you forward in the filename. The Select key on the front panel generates a space character. When you are done entering the filename press the Done softkey. This returns back to the **File Open** dialog and menu, but does not cause the save to occur.

## Save As Type

This field shows the file suffix for the type of file you have selected to save. For example, if you navigated here while saving State, "Mode state (\*.state)" is in the field. If you navigated here from saving Trace, ""Mode state (\*.trace)" is in the field. If you navigated here while exporting a trace data file, "Trace Data (\*.csv)" is in the field. For some file types, there is more than one choice in the dropdown, which you can select by using the up and down arrow keys and Enter.

## Up One Level

This key corresponds to the icon of a folder with the up arrow that is in the tool bar of the dialog. When pressed, it causes the file and folder list to navigate up one level in the directory structure. The Backspace key does the same thing.

## Create New Folder

This key corresponds to the icon of a folder with the "\*" that is in the tool bar of the dialog. When pressed, a new folder is created in the current directory with the name **New Folder** and you can enter a new folder name using the Alpha Editor.

## Cancel

This key corresponds to the Cancel selection in the dialog. It causes the current **Save As** request to be cancelled. The ESC key does the same thing.

Key Path	Save, State
Mode	All
Notes	Brings up Save As dialog for saving a State Save Type
Initial S/W Revision	Prior to A.02.00

## Edit Register Names

You may enter a custom name on any of the Register keys, to help you remember what you are using that state to save. To do this, press the Edit Register Names key, choose the register whose name you wish to edit, and then enter the desired label using the Alpha Editor or an external PC keyboard.

The maximum number of characters that can be added is 30. In most cases, 30 characters will fit on two lines of the key.

See ["More Information" on page 984](#)

Key Path	Save, State
Mode	All
<b>Remote Command</b>	:MMEMory:REGister:STATe:LABel <reg number>,"label" :MMEMory:REGister:STATe:LABel? <reg number>
<b>Example</b>	:MMEM:REG:STAT:LAB 1,"my label"
Notes	<reg number> is an integer from 1 to 16. If the SCPI specifies an invalid register number an error message is generated, -222,"Data out of range;Invalid register label number" "label" is a string from 0 to 30 characters in length. If a label exceeds 30 characters, an error message is generated, -150,"String data error;Label clipped to 30 characters" "label" of length 0 erases the custom label and restores the default (time and date) label. E.g.: :MMEM:REG:STAT:LAB 1,""
Dependencies	N9060A-7FP or N9060B-2FP license required to edit the register names. When the feature is not licensed, sending this command generates an error, -221,"Settings conflict;Option not available"
Preset	The names are unaffected by Preset or power cycle but are set to the default label (time and date) on a "Restore System Defaults->Misc"
Initial S/W Revision	A.11.00

## More Information

When you edit one of the register names, the time and date field will be replaced by the custom name.

If you delete all the characters in the custom name, it restores the default (time and date).

The register names are stored within the state files, but they are not part of the instrument state; that is, once you have edited a register name, loading a new state will not change that register name. Another consequence of this is that the names will be persistent through a power cycle. Also, if a named state file is transferred to another analyzer, it will bring its custom name along with it.



If you try to edit the name of an empty register, the analyzer will first save the state to have a file to put the name in. If you load a named state file into an analyzer with older firmware it will ignore the metadata.

The \*SAV and \*RCL commands will not be affected by the custom register names, nor will the MMEM commands.

### Register 1 thru Register 16

Selecting any one of these register menu keys causes the State of the currently active mode to be saved to the specified Register. The registers are provided for rapid saving and recalling, since you do not need to specify a filename or navigate to a file. Each of the register menu keys annotates whether it is empty or at what date and time it was last modified. In addition, you can use the Edit Register Names key to enter custom names for each register.

Although these 16 registers are the only registers available from the front panel, there are 128 state registers available in the instrument. Registers 17–128 are only available from the SCPI interface, using the \*SAV command.

There is one set of 128 state registers in the instrument, not one set for each Mode. When a state is saved, the Mode it was saved from is saved with it; then when it is recalled, the instrument switches to that Mode.

After the save completes, the corresponding register menu key annotation is updated with the date and time and the message "Register <register number> saved" is displayed.

Key Path	Save, State
Mode	All
<b>Example</b>	*SAV 1
Range	1–16 from front panel, 1–128 from SCPI
Readback	Date and time with seconds resolution are displayed on the key OR A custom name of up to 30 characters entered using the Edit Register Names key OR “(empty)” if no prior save operation has been performed to this register.
Initial S/W Revision	Prior to A.02.00
Modified at S/W Revision	A.11.00

### Register 1 thru Register 16

Selecting any one of these register menu keys causes the State of the currently active mode to be saved to the specified Register. The registers are provided for rapid saving and recalling, since you do not need to specify a filename or navigate to a file. Each of the register menu keys annotates whether it is empty or at what date and time it was last modified. In addition, you can use the Edit Register Names key to enter custom names for each register.

Although these 16 registers are the only registers available from the front panel, there are 128 state registers available in the instrument. Registers 17–128 are only available from the SCPI interface, using the \*SAV command.

There is one set of 128 state registers in the instrument, not one set for each Mode. When a state is saved, the Mode it was saved from is saved with it; then when it is recalled, the instrument switches to that Mode.

After the save completes, the corresponding register menu key annotation is updated with the date and time and the message "Register <register number> saved" is displayed.

Key Path	Save, State
Mode	All
Example	*SAV 1
Range	1-16 from front panel, 1-128 from SCPI
Readback	Date and time with seconds resolution are displayed on the key OR A custom name of up to 30 characters entered using the Edit Register Names key OR “(empty)” if no prior save operation has been performed to this register.
Initial S/W Revision	Prior to A.02.00
Modified at S/W Revision	A.11.00

## Data (Export)

Exporting a data file stores data from the current measurement to mass storage files. The Export Menu only contains data types that are supported by the current measurement.

Since the commonly exported data files are in .csv format, the data can be edited by you prior to importing. This allows you to export a data file, manipulate the data in Excel (the most common PC Application for manipulating .csv files) and then import it.

Selecting an Export Data menu key will not actually cause the exporting to occur, since the analyzer still needs to know where you wish to save the data. Pressing the Save As key in this menu brings up the Save As dialog and Save As menu that allows you to specify the destination file and directory. Once a filename has been selected or entered in the Open menu, the export will occur as soon as the Save key is pressed.

Key Path	Save
Mode	All
Notes	The menu is built from whatever data types are available for the mode. So the key locations in the sub menu will vary.  No SCPI command directly controls the Data Type that this key controls. The Data Type is included in the MMEM:STORe commands.
Dependencies	If a file type is not used by a certain measurement, that type is grayed out for that measurement. The key for a file type will not show at all if there are no measurements in the Mode that support it.
Preset	Is not affected by a Preset or shutdown, but is reset during Restore Mode Defaults
Readback	The data type that is currently selected
Initial S/W Revision	Prior to A.02.00

## Amplitude Correction

Pressing this key selects **Amplitude Corrections** as the data type to be exported. Pressing this key again brings up the Select Menu, which allows the user to select which **Amplitude Correction** to save.

Amplitude Corrections are fully discussed in the documentation of the Input/Output key, under the Corrections softkey.

See "[Correction Data File](#)" on page 987

Key Path	Save
<b>Remote Command</b>	:MMEMory:STORe:CORRection 1 2 3 4 5 6, <filename>
<b>Example</b>	:MMEM:STOR:CORR 2 "myAmpcor.csv" saves Correction 2 to the file myAmpcor.csv on the current path. The default path is My Documents\amplitudeCorrections.
Notes	If the save is initiated via SCPI, and the file already exists, the file will be overwritten. Using the C: drive is strongly discouraged, since it runs the risk of being overwritten during an instrument software upgrade. Both single and double quotes are supported for any filename parameter over SCPI.
Dependencies	Corrections are not supported by all Measurements. If in a Mode in which some Measurements support it, this key will be grayed out in measurements that do not. The key will not show at all if no measurements in the Mode support it. This key will not appear unless you have the proper option installed in your instrument.
Readback	Selected Correction
<b>Backwards Compatibility SCPI</b>	:MMEMory:STORe:CORRection ANTenna   CABLe   OTHer   USER, <filename> For backwards compatibility, ANTenna maps to 1, CABLe maps to 2, OTHer maps to 3 and USER maps to 4
Initial S/W Revision	A.02.00

## Correction Data File

A Corrections Data File contains a copy of one of the analyzer correction tables. Corrections provide a way to adjust the trace display for predetermined gain curves (such as for cable loss).

Corrections files are text files in .csv (comma separated values) form, to make them importable into Excel or other spreadsheet programs. The format for Corrections files is as follows.

Line #	Type of field	Example	Notes
1	File type, must be "Amplitude Correction"	Amplitude Correction	May not be omitted
2	File Description (in quotes)	"Correction Factors for 11966E"	60 characters max; may be empty but may not be omitted. If exceeds 60 characters, error -233 Too much data reported
3	Comment (in quotes)	"Class B Radiated"	60 characters max; may be empty but

Line #	Type of field	Example	Notes
			may not be omitted. . If exceeds 60 characters, error -233 Too much data reported
4	Instrument Version, Model #	A.02.06,N9020A	May be empty but may not be omitted
5	Option List, File Format Version	K03 LFE EXM ,01	May be empty but may not be omitted
6	Freq Unit to be used for all frequency values in the file	Frequency Unit,MHz	assumed to be Hz if omitted
7	Antenna Unit	Antenna Unit,None	If omitted leaves the Antenna unit unchanged. The amplitude unit in the Antenna Unit field is a conversion factor that is used to adjust the Y Axis Units of the current mode, if the mode supports Antenna Units. For more details on antenna correction data, refer to the Input/Output,Corrections key description. Allowable values: dBuV/m, dBuA/m, dBG, dBpT, None
8	Freq Interpolation	Frequency Interpolation,Linear	if omitted leaves the Freq Interpolation unchanged. Allowable values: Linear, Logarithmic
9	Bias value in mA	Bias,0.00	If omitted leaves the Bias value unchanged (added as of A.08.50)
10	Bias State	Bias State,On	If omitted leaves the Bias State unchanged. Allowable values: On, Off (added as of A.08.50)
11	Overlap, two values, Freq1 and Freq2, separated by commas.	Overlap,33500,40000	Uses Freq Unit from line 6. Thus, in this example Freq1=33.5 GHz, Freq2= 40.0 GHz (see note below). If omitted leaves the overlap unchanged (added as of A.08.50)
12	DATA marker	DATA	Corrections data begins in the next line

Lines 2 through 5 can be empty but must appear in the file. Lines 6 through 11 are optional, the lines can be left out of the file altogether.

The Overlap row and the two Bias rows apply only to external mixing. Both are read-only, they are never written by the analyzer. The only way to insert or modify these rows is to edit the file with a text editor or a spreadsheet editor. These rows are intended for use by mixer manufacturers, as they allow the manufacturer to insert data about how the mixer corrections were generated and how they should be applied. The Bias rows allow you to specify whether to turn Bias on or off when the Correction is turned on and to specify a Bias value (turning off the Correction does not change the Bias, but turning it back on again sets it to the value specified in the file). The Overlap row allows you to specify an overlap region in which

two different corrections may be applied. It is expected that in the corrections data itself, there will be TWO corrections values exactly at Max Freq, otherwise Overlap is ignored. The way the overlap is processed is as follows: if at any given time the current analyzer Start Freq is greater than Freq 1 and lower than Freq 2, and the current Stop Freq is greater than Freq 2, extend the first correction point at or above Freq 2 down to Freq 1, rather than using the correction data between Freq1 and Freq2.

The Antenna Unit row can only be used in Correction register 1, because there can only be one setting for Antenna Unit at any given time. If a Correction whose Antenna Unit is set to anything but None is loaded into any Correction register but 1, an error is generated (Mass storage error; Can only load an Antenna Unit into Correction 1). When a correction file is saved from any Correction register but 1, Antenna Unit is always written as None.

Similarly, the Bias rows can only be used in Correction register 1, because there can only be one setting for Bias at any given time. If a Correction file with a Bias or Bias State row is loaded into any Correction register but 1, an error is generated: Mass storage error; Can only load Bias Settings into Correction 1

The data follows the DATA row, as comma separated X, Y pairs; one pair per line.

For example, suppose you have an Antenna to correct for on an N9020A version A.02.06 and the correction data is:

- 0 dB at 200 MHz
- 17 dB at 210 MHz
- 14.8 dB at 225 MHz

Then the file will look like:

- Amplitude Correction
- "Correction Factors for 11966E"
- "Class B Radiated"
- A.02.06,N9020A
- P13 EA3 UK6,01
- Frequency Unit,MHz
- Antenna Unit,dBuV/m
- Frequency Interpolation,Linear
- DATA
- 200.000000,0.00
- 210.000000,17.00
- 225.000000,14.80

The choices for the 1 of N fields in the metadata are as follows:

- Frequency Unit: Hz, kHz, MHz, GHz
- Antenna Unit: dBuV/m, dBuA/m, dBG, dBpT, None

- Frequency Interpolation: Logarithmic, Linear

## Trace

Pressing this key selects Traces as the data type to be exported. Pressing this key when it is already selected brings up the Trace Menu, which allows you to select which Trace to save.

Key Path	Save, Data
Remote Command	:MMEMory:STORe:ATRACE MEAS MEAS2 ELIMit ALL, <filename>
Example	:MMEM:STOR:ATR MEAS, "MyApdTrace.csv" exports Measured Trace to the file MyApdTrace.csv in the current path. The default path is My Documents\EMI\data\APD\Traces.
Notes	If the save is initiated via SCPI, and the file already exists, the file will be overwritten. Using the C: drive is strongly discouraged, since it runs the risk of being overwritten during an instrument software upgrade. Both single and double quotes are supported for any filename parameter over SCPI.
Dependencies	Traces cannot be recalled from a trace file that was saved with ALL traces selected.
Readback	Selected Trace
Status Bits/OPC dependencies	Sequential - waits for previous measurement to complete
Initial S/W Revision	A.13.00

## APD Trace File Content

The following file example shows the Trace file content in Excel for one trace.

Trace	
EMI:APD	
A.12.50	N9038A
526 EA3 B25 P26 PFR	1
Amptd Unit	
dBuV	
DATA	
Trace1	
18.81050082	0.677811275
18.90460178	0.672439196
18.99870273	0.666681778
19.09280368	0.661241698
19.186897	0.65548428
19.28099796	0.650293538
19.37509891	0.644037446

19.46919986	0.638484031
19.56330081	0.632386608
19.65740176	0.626085183
19.75150272	0.619035746
19.84560367	0.612008976
19.93969699	0.604778203
20.03379794	0.598635447
20.1278989	0.592334021
20.22199985	0.585579255
20.3161008	0.578461817

## Limit

Pressing this key selects Limit Lines as the data type to be exported. Pressing the key a second time brings up the Limit Menu that allows you to select which Limit Line to save. However, currently there is only 1 limit line for the APD measurement.

Key Path	Save, Data
<b>Remote Command</b>	:MMEMory:STORe:ALIMit LLINE1, <filename>
<b>Example</b>	:MMEM:STOR:ALIM LLINE1, " myAPDLimit.csv" saves the Limit Line to the file myAPDLimit.csv in the current path. The default path is My Documents\EMI\data\APD\Limits.
Notes	If the save is initiated via SCPI, and the file already exists, the file will be overwritten. Using the C: drive is strongly discouraged, since it runs the risk of being overwritten during an instrument software upgrade. Both single and double quotes are supported for any filename parameter over SCPI.
Dependencies	This key will only appear if you have the proper option installed in your instrument.
Preset	1; not part of Preset, but is reset by Restore Mode Defaults and survives power cycles.
State Saved	The selected Limit number is saved in instrument state.
Readback	Selected Limit Line
Status Bits/OPC dependencies	Sequential - waits for previous measurement to complete
Initial S/W Revision	A.13.00

## APD Limit File Content

The following file example shows the Limit file content in comma separated values when the APD Method is set to:

(a)Disturbance Level

Limit

11 APD Measurement  
Save

""

""

\*,Zorro

None,\*

Frequency Unit, MHz

Amplitude Unit, dBuV

APD Method, DistLevel

Prblty, 0.1

DATA

400, 47.0000000033602

600, 47.0000000033602

(b)Probability

Limit

""

""

\*,Zorro

None,\*

Frequency Unit, MHz

Amplitude Unit, dBuV

APD Method, Probability

Dist Level, 26.0000000033602

DATA

400, 0.1

600, 0.1

## Signal List

Pressing this key selects Signal List as the data type to be exported with a save request. The next step is to select the Save As key in the Save Data menu.

Key Path	Save, Data
Remote Command	:MMEMory:STORe:ALIS <filename>
Example	MMEM:STOR:ALIS "APDList.csv" exports the Signal List to the file APDList.csv in the current path. The default path is My Documents\EMI\data\APD\SignalList.
Notes	If the save is initiated via SCPI, and the file already exists, the file will be overwritten.



---

Using the C: drive is strongly discouraged, since it runs the risk of being overwritten during an instrument software upgrade.

Both single and double quotes are supported for any filename parameter over SCPI.

---

Initial S/W Revision      A.13.00

---

## APD Signal List File Content

The following file example shows the Signal List file content in comma separated values.

SignalList

EMI:APD

A.12.50,N9038A

526 B25 CNF CR3 DP2 EMC NFE P26 PFR TDS YAS ,01

Amplitude Unit,dBuV

DATA

SIG,MRK,TRC,FREQ,DIST LEVEL,PRBLTY,DIST LEVEL DELTA,PRBLTY DELTA,TIMESTAMP,COMMENT

1,False,1,450000000,18.8105008246102,0.599179454632001,-  
88.17919921875,0.499179454632001,2012/11/06 23:55:580.499179454632001,**p** meas diff from **p** limit

2,False,1,515000000,26.0000000033602,0.141374073486411,0,0.0413740734864111,2012/11/07  
02:18:540.0413740734864111,

## Save As . . .

When you press “Save As”, the analyzer brings up a Windows dialog and a menu entitled “**Save As.**” This menu allows you to navigate to the various fields in the Windows dialog without using a keyboard or mouse. The Tab and Arrow keys can also be used for dialog navigation.

See "[To File . . .](#)" on page 1096 in Save, State for a full description of this dialog and menu.

The default path for saving files is:

For all of the Trace Data Files:

My Documents\`<mode name>`\data\traces

For all of the Limit Data Files:

My Documents\`<mode name>`\data\limits

For all of the Measurement Results Data Files:

My Documents\`<mode name>`\data\`<measurement name>`\results

For all of the Capture Buffer Data Files:

My Documents\`<mode name>`\data\captureBuffer

Key Path	Save, Data
Mode	All
Notes	The key location is mode-dependent and will vary. Brings up the Save As dialog for saving a <mode specific> Save Type. The save is performed immediately and does not wait until the measurement is complete.
Initial S/W Revision	Prior to A.02.00

### Screen Image

Pressing Screen Image accesses a menu of functions that enable you to specify a format and location for the saved screen image. It brings up a menu that allows you to specify the color scheme of the Screen Image (Themes) or navigate to the Save As dialog to perform the actual save.

Screen Image files contain an exact representation of the analyzer display. They cannot be loaded back onto the analyzer, but they can be loaded into your PC for use in many popular applications.

The image to be saved is actually captured when the Save front panel key is pressed, and kept in temporary storage to be used if you ask for a Screen Image save. When the Screen Image key is pressed, a "thumbnail" of the captured image is displayed, as shown below:

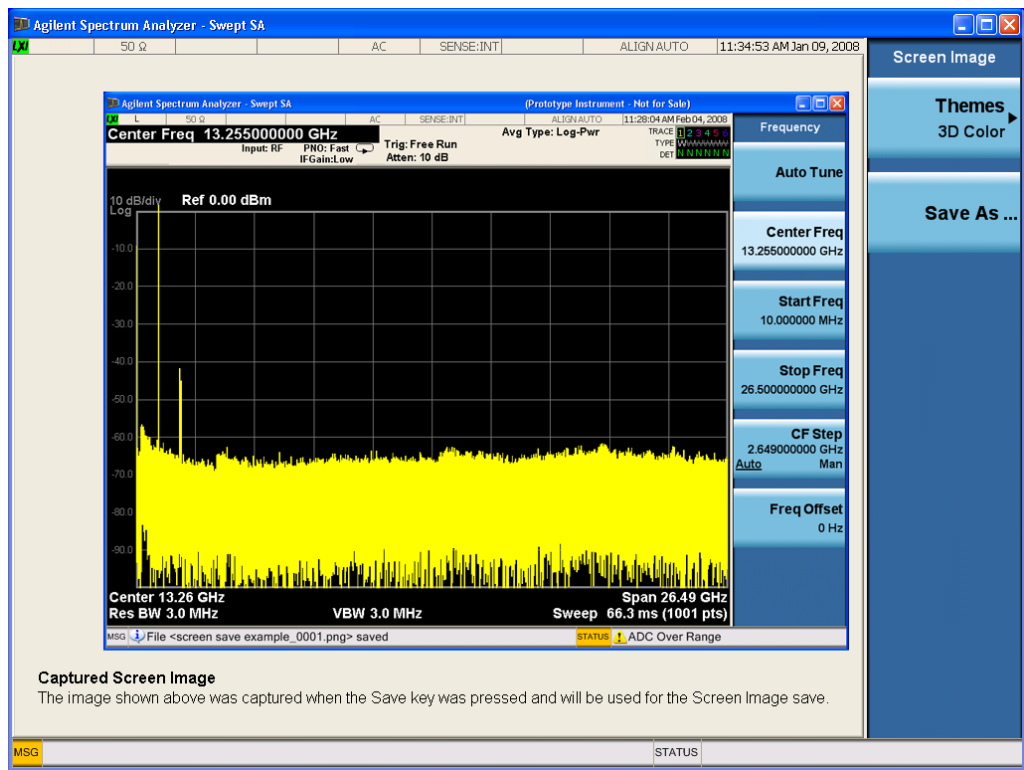

When you continue on into the Save As menu and complete the Screen Image save, the image depicted in the thumbnail is the one that gets saved, showing the menus that were on the screen before going into the Save menus. The save is performed immediately and does not wait until the measurement is complete.

After you have completed the save, the Quick Save front-panel key lets you quickly repeat the last save performed, using an auto-named file, with the current screen data.

**NOTE**

For versions previous to A.01.55, if you initiate a screen image save by navigating through the Save menus, the image that is saved will contain the Save menu softkeys, not the menus and the active function that were on the screen when you first pressed the Save front panel key.

Key Path	Save
Mode	All
Remote Command	:MMEMory:STORe:SCReem <filename>
Example	:MMEM:STOR:SCR "myScreen.png" This stores the current screen image in the file MyScreenFile.png in the default directory.
Initial S/W Revision	Prior to A.02.00

## Themes

Accesses a menu of functions that enable you to choose the theme to be used when saving the screen image.

The **Themes** option is the same as the **Themes** option under the **Display** and **Page Setup** dialogs. It allows you to choose between themes to be used when saving the screen image.

Key Path	Save, Screen Image
Remote Command	:MMEMory:STORe:SCReem:THEMe TDColor   TDMonochrome   FCOLOR   FMONochrome  :MMEMory:STORe:SCReem:THEMe?
Example	:MMEM:STOR:SCR:THEM TDM
Preset	3D Color; Is not part of Preset, but is reset by Restore Misc Defaults or Restore System Defaults All and survives subsequent running of the modes.
Readback	3D Color   3D Mono   Flat Color   Flat Mono
Backwards Compatibility Notes	In ESA and PSA we offer the choice of "Reverse Bitmap" or "Reverse Metafile" when saving screen images. This is much like the "Flat Color" theme available in X-Series. Also, if you selected Reverse Bitmap AND a black & white screen image, that would be much like "Flat Monochrome". In other words, each of the X-Series themes has a similar screen image type in ESA/PSA. But they are not identical.
Initial S/W Revision	Prior to A.02.00

## 3D Color

Selects a standard color theme with each object filled, shaded and colored as designed.

Key Path	Save, Screen Image, Themes
Example	MMEM:STOR:SCR:THEM TDC

Readback	3D Color
Initial S/W Revision	Prior to A.02.00

### 3D Monochrome

Selects a format that is like 3D color but shades of gray are used instead of colors.

Key Path	Save, Screen Image, Themes
<b>Example</b>	MMEM:STOR:SCR:THEM TDM
Readback	3D Mono
Initial S/W Revision	Prior to A.02.00

### Flat Color

Selects a format that is best when the screen is to be printed on an ink printer.

Key Path	Save, Screen Image, Themes
<b>Example</b>	MMEM:STOR:SCR:THEM FCOL
Readback	Flat Color
Initial S/W Revision	Prior to A.02.00

### Flat Monochrome

Selects a format that is like Flat Color. But only black is used (no colors, not even gray), and no fill.

Key Path	Save, Screen Image, Themes
<b>Example</b>	MMEM:STOR:SCR:THEM FMON
Readback	Flat Mono
Initial S/W Revision	Prior to A.02.00

### Save As...

When you press "Save As", the analyzer brings up a Windows dialog and a menu entitled "**Save As.**" This menu allows you to navigate to the various fields in the Windows dialog without using a keyboard or mouse. The Tab and Arrow keys can also be used for dialog navigation.

See "[To File . . .](#)" on page 1096 in Save, State for a full description of this dialog and menu.

The default path for Screen Images is

My Documents\`<mode name>`\screen.

where <mode name> is the parameter used to select the mode with the INST:SEL command (for example, SA for the Spectrum Analyzer).

Key Path	Save, Screen Image
Notes	Brings up Save As dialog for saving a Screen Image Save Type
Initial S/W Revision	Prior to A.02.00

### Mass Storage Catalog (Remote Command Only)

Key path	SCPI Only
<b>Remote Command</b>	:MMEMory:CATalog? [<directory_name>]
Notes	<p>The string must be a valid logical path.</p> <p>Queries disk usage information (drive capacity, free space available) and obtains a list of files and directories in a specified directory in the following format:          &lt;numeric_value&gt;,&lt;numeric_value&gt;,{&lt;file_entry&gt;}</p> <p>It returns two numeric parameters and as many strings as there are files and directories. The first parameter indicates the total amount of storage currently used in bytes. The second parameter indicates the total amount of storage available, also in bytes. The &lt;file_entry&gt; is a string. Each &lt;file_entry&gt; indicates the name, type, and size of one file in the directory list:          &lt;file_name&gt;,&lt;file_type&gt;,&lt;file_size&gt;</p> <p>As the windows file system has an extension that indicates file type, &lt;file_type&gt; is always empty. &lt;file_size&gt; provides the size of the file in bytes. For directories, &lt;file_entry&gt; is surrounded by square brackets and both &lt;file_type&gt; and &lt;file_size&gt; are empty</p>
Initial S/W Revision	Prior to A.02.00

### Mass Storage Change Directory (Remote Command Only)

Key path	SCPI Only
<b>Remote Command</b>	:MMEMory:CDIRectory [<directory_name>] :MMEMory:CDIRectory?
Notes	<p>The string must be a valid logical path.</p> <p>Changes the default directory for a mass memory file system. The &lt;directory_name&gt; parameter is a string. If no parameter is specified, the directory is set to the *RST value.</p> <p>At *RST, this value is set to the default user data storage area, that is defined as System.Environment.SpecialFolder.Personal.</p> <p>Query returns full path of the default directory.</p>
Initial S/W Revision	Prior to A.02.00

## Mass Storage Copy (Remote Command Only)

Key path	SCPI Only
<b>Remote Command</b>	:MMEMory:COpy <string>,<string>[,<string>,<string>]
Notes	<p>The string must be a valid logical path.</p> <p>Copies an existing file to a new file or an existing directory to a new directory.</p> <p>Two forms of parameters are allowed. The first form has two parameters. In this form, the first parameter specifies the source, and the second parameter specifies the destination.</p> <p>The second form has four parameters. In this form, the first and third parameters specify the source. The second and fourth parameters specify the directories. The first pair of parameters specifies the source. The second pair specifies the destination. An error is generated if the source doesn't exist or the destination file already exists.</p> <p>This command will generate an "access denied" error if the destination is a restricted folder (e.g., C:\Windows) and the current user does not have Power User or Administrator privileges.</p>

## Mass Storage Device Copy (Remote Command Only)

This command transfers data to/from a file and a peripheral device.

Key path	SCPI Only
<b>Remote Command</b>	:MMEMory:COpy:DEvice <source_string>,<dest_string>
Notes	<p>The strings must be a valid logical path or a valid device keyword. If the dest_string is a device keyword, the data is copied from the source file to the device. If the source_string is a device keyword, the data is copied to the source file from the device.</p> <p>Valid device keywords are:</p> <p>SNS (smart noise source)</p> <p>An error is generated if the file or device is not found.</p>

## Mass Storage Delete (Remote Command Only)

Key path	SCPI Only
<b>Remote Command</b>	:MMEMory:DElete <file_name>[,<directory_name>]
Notes	<p>The string must be a valid logical path.</p> <p>Removes a file from the specified directory. The &lt;file_name&gt; parameter specifies the file name to be removed. This command will generate an "access denied" error if the file is in a restricted folder (e.g., C:\Windows) and the current user does not have Power User or Administrator privileges.</p>
Initial S/W Revision	Prior to A.02.00

## Mass Storage Data (Remote Command Only)

Creates a file containing the specified data OR queries the data from an existing file.

Key path	SCPI Only
<b>Remote Command</b>	:MMEMory:DATA <file_name>, <data> :MMEMory:DATA? <file_name>
Notes	The string must be a valid logical path. The command form is MMEMory:DATA <file_name>,<data>. It loads <data> into the file <file_name>. <data> is in 488.2 block format. <file_name> is string data. The query form is MMEMory:DATA? <file_name> with the response being the associated <data> in block format.
Initial S/W Revision	Prior to A.02.00

### Mass Storage Make Directory (Remote Command Only)

Key path	SCPI Only
<b>Remote Command</b>	:MMEMory:MDIRectory <directory_name>
Notes	The string must be a valid logical path. Creates a new directory. The <directory_name> parameter specifies the name to be created. This command will generate an “access denied” error if the new directory would be in a restricted folder (e.g., C:\Windows) and the current user does not have Power User or Administrator privileges.
Initial S/W Revision	Prior to A.02.00

### Mass Storage Move (Remote Command Only)

Key path	SCPI Only
<b>Remote Command</b>	:MMEMory:MOVE <string>,<string>[,<string>,<string>]
Notes	The string must be a valid logical path. Moves an existing file to a new file or an existing directory to a new directory. Two forms of parameters are allowed. The first form has two parameters. In this form, the first parameter specifies the source, and the second parameter specifies the destination. The second form has four parameters. In this form, the first and third parameters specify the source. The second and fourth parameters specify the directories. The first pair of parameters specifies the source. The second pair specifies the destination. An error is generated if the source doesn't exist or the destination file already exists. This command will generate an “access denied” error if the destination is a restricted folder (e.g., C:\Windows) and the current user does not have Power User or Administrator privileges.
Initial S/W Revision	Prior to A.02.00

## Mass Storage Remove Directory (Remote Command Only)

Key path	SCPI Only
<b>Remote Command</b>	:MMEMory:RDIRectory <directory_name>
Notes	<p>The string must be a valid logical path.</p> <p>Removes a directory. The &lt;directory_name&gt; parameter specifies the directory name to be removed. All files and directories under the specified directory shall also be removed.</p> <p>This command will generate an “access denied” error if the folder is a restricted folder (e.g., C:\Windows) or is in a restricted folder and the current user does not have Power User or Administrator privileges.</p>
Initial S/W Revision	Prior to A.02.00



## Single (Single Measurement/Sweep)

Sets the analyzer for Single measurement operation. The single/continuous state is Meas Global, so the setting will affect all the measurements. If you are Paused, pressing Single does a Resume.

See ["More Information" on page 1001](#)

Key Path	Front-panel key
Example	:INIT:CONT OFF
Notes	See Cont key description.
Backwards Compatibility Notes	<p>For Spectrum Analysis mode in ESA and PSA, the Single hardkey and the INITiate:IMM switched from continuous measurement to single measurement and restarted sweeps and averages (displayed average count reset to 1), but did not restart Max Hold and Min Hold. In the X-Series, the Single hardkey and the INITiate:IMM command initiate a sweep/ measurement/ average sequence/hold sequence including MaxHold and MinHold.</p> <p>For Spectrum Analysis mode in ESA and PSA, the Single hardkey restarted the sweep regardless of whether or not you were in an active sweep or sweep sequence. In the X-Series, Restart does this but Single only restarts the sweep or sweep sequence if you are in the idle state.</p> <p>INIT[:IMM] in ESA &amp; PSA Spectrum Analysis Mode does an implied ABORT. In some other PSA Modes, INIT[:IMM] is ignored if not in the idle state. . The X-Series follows the ESA/PSA SA Mode model, which may cause some Modes to have compatibility problems.</p>
Initial S/W Revision	Prior to A.02.00

### More Information

See ["Restart" on page 1093](#) for details on the INIT:IMMEDIATE (Restart) function.

If you are already in single sweep, the INIT:CONT OFF command has no effect.

If you are already in Single Sweep, then pressing the Single key in the middle of a sweep does not restart the sweep or sequence. Similarly, pressing the Single key does not restart the sweep or sequence if the sweep is not in the idle state (for example, if you are taking a very slow sweep, or the analyzer is waiting for a trigger). Instead, it results in a message. "Already in Single, press Restart to initiate a new sweep or sequence". Even though pressing the Single key in the middle of a sweep does not restart the sweep, sending INIT:IMMEDIATE does reset it.

To take one more sweep without resetting the average count, increment the average count by 1, by pressing the step up key while **Average/Hold Number** is the active function, or sending the remote command CALC:AVER:TCON UP.

## Source

There is no Source control functionality for this measurement. When this key is pressed, the screen either displays a blank menu, or the previously-selected menu remains unchanged.

---

Key Path	Front-panel key
----------	-----------------

---

## SPAN X Scale

Displays the menu keys that enable you to change the span parameters.

Key Path	Front-panel key
Notes	Front panel only.
Initial S/W Revision	A.13.00

## Reference Level

The reference level specifies the amplitude represented by the right most graticule line on the X-axis.

Key Path	Span X Scale
<b>Remote Command</b>	:DISPlay:APD:VIEW[1]:WINDow[1]:TRACe:X[:SCALe]:RLEVel <real> :DISPlay:APD:VIEW[1]:WINDow[1]:TRACe:X[:SCALe]:RLEVel?
<b>Example</b>	DISP:APD:VIEW:WIND:TRAC:X:RLEV 80 dBuV DISP:APD:VIEW:WIND:TRAC:X:RLEV?
Couplings	If you reduce the attenuation, the analyzer may have to lower the reference level to keep it below its allowed maximum. This allowed maximum level is specified in the "Max" row, below, along with other variables which affect it. When you increase attenuation, the reference level does not change.
Preset	106.98 dBuV
State Saved	Saved in instrument state
Min	RefLevelMin = -29.31 dBuV - ExtGain.
Max	RefLevelMax = 153.11 dBuV - External Gain
Default Unit	Depends on the current selected Amplitude unit
Initial S/W Revision	A.13.00

## Scale/Div

This key enables you to enter a time value to change the horizontal scale.

Key Path	Span X Scale
<b>Remote Command</b>	:DISPlay:APD:VIEW[1]:WINDow[1]:TRACe:X[:SCALe]:PDIVision <rel_ampl> :DISPlay:APD:VIEW[1]:WINDow[1]:TRACe:X[:SCALe]:PDIVision?
<b>Example</b>	DISP:APD:VIEW:WIND:TRAC:X:PDIV 10 DISP:APD:VIEW:WIND:TRAC:X:PDIV?
Preset	10
State Saved	Saved in instrument state
Min	1.0

11 APD Measurement  
SPAN X Scale

---

Max	20.0
Default Unit	dB

---

## Sweep/Control

Displays the menu keys that enable you to control the sweep parameters.

Key Path	Front-panel key
Notes	Front panel only.
Initial S/W Revision	A.13.00

### Pause/Resume

Pauses the automated APD measurement that is initiated by the Start Measure key after the current data acquisition is complete. When paused, the label on the key changes to “Resume”. Pressing the Resume key resumes the measurement at the point it was at when paused.

Key Path	Sweep/ Control
<b>Remote Command</b>	:INITiate:PAUSE
<b>Example</b>	INIT:PAUS
Dependencies	Pause is not available when the automated APD measurement is not running.
Couplings	When paused, the label on the key changes to “Resume”.
Initial S/W Revision	A.13.00

Key Path	Sweep/ Control
<b>Remote Command</b>	:INITiate:RESume
<b>Example</b>	INIT:RES
Dependencies	Resume is not available when the automated APD measurement is not running.
Couplings	When resumed, the label on the key changes to “Pause”.
Initial S/W Revision	A.13.00

### Start Measure/ Stop

When this key is pressed, the analyzer executes an automated APD measurement based on the Measure selection in the Meas Setup menu, i.e. all signals or mark signals, and then returned.

If the limit table is empty when this key is pressed, a prompt message is placed on the screen that says:

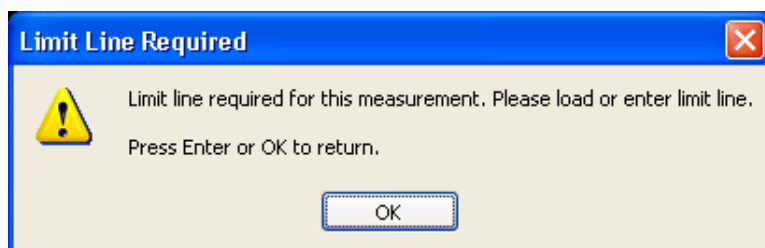

If the limit table is not empty, but it is turned off, a prompt message is placed on the screen that says:

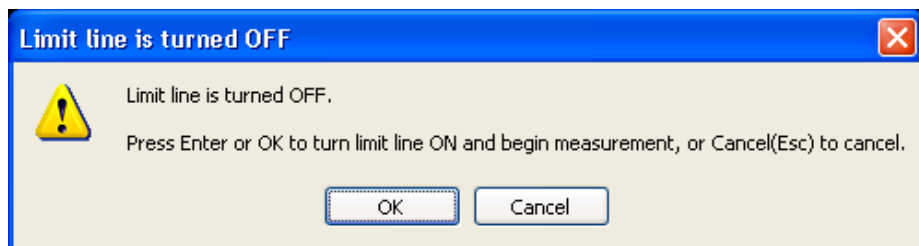

During the automated measurement, the APD will be measured at each signal frequency in the list using Measured Trace. Depending on the APD method set in the limit, the corresponded E meas for a given probability  $p$  limit or  $p$  meas for a given E limit will be updated onto the signal list. If the point does not exist on the APD trace, the interpolated value will be updated. Delta to limit values will be updated. Any positive limit delta value is shown in red.

If there is no limit defined for the signal frequency, E meas or  $p$  meas will be updated onto signal list, and Delta To Limit values will be shown as "--". "No limit defined for this freq" will be added to the comment column.

You may pause or stop the measurement. When the measurement is complete, the analyzer restores the frequency and continuous mode setting to their pre-Automated Measurement values and the normal APD measurement resumes.

Key Path	Sweep/Control
Remote Command	INITiate:APD:SMEasure
Example	INIT:APD:SME
Notes	If the signal list contains no data, an error is generated and the measurement cannot be started.
Couplings	When started, the label on the key changes to "Stop". Performing Start Measure would turn on Measured Trace, and set it to Trace On. Measurement completion does not restore the previous value.
Status Bits/OPC Dependencies	This is an Overlapped command. OPC is set as a result of this command's action finishing.
Initial S/W Revision	A.13.00

Key Path	Sweep/Control
Remote Command	INITiate:APD:STOP
Example	INIT:APD:STOP
Notes	If the stop command is sent when there is no automated APD measurement running, it will: - abort and restart APD trace acquisition if it is in continuous mode - abort APD trace acquisition if it is in single mode
Couplings	When stopped, the label on the key changes to "Start Measure".
Backwards Compatibility SCPI	INIT:ABOR
Initial S/W Revision	A.13.00



11 APD Measurement  
System

## System

See "[System](#)" on page 272



## Trace/Detector

Displays a menu of keys that enable you to control the trace setting for the APD trace window.

Key Path	Front-panel key
Notes	Front panel only.
Initial S/W Revision	A.13.00

### Select Trace

Determines which trace the type control keys will affect. When you select a trace, it makes that trace the current trace, so it displays on top of all of the other traces.

Key Path	Trace/ Detector
Notes	Front panel only.
Preset	Measured
State Saved	Saved in instrument state.
Initial S/W Revision	A.13.00

### View/Blank

This key lets you set the state of the two trace variables, Update and Display. The four choices available in this 1-of-N menu are:

- Trace On: Update and Display both On
- View: Update Off and Display On
- Blank: Update Off and Display Off
- Background: Update On, Display Off (this allows a trace to be blanked and continue to update “in the background”)

Key Path	Trace/Detector
Notes	The four states of this 1-of-N actually set two variables, Update and Display, to their four possible combinations: Trace On: Update and Display both On View: Update Off and Display On Blank: Update Off and Display Off Background: Update On, Display Off See the following tables, " <a href="#">Trace Update State (Remote Command Only)</a> " on page 1010 and " <a href="#">Trace Display State (Remote Command Only)</a> " on page 1010, for details on the SCPI to control these two variables.
Couplings	Loading a trace from a file puts that trace in View regardless of the state it was in when it was saved.

	When a View/ Blank selection is made, the menu returns to the previous menu.
Readback Text	Trace On View Blank Background
Initial S/W Revision	A.13.00

### Trace Update State (Remote Command Only)

Toggles the trace update state.

Key Path	Trace/Detector
<b>Remote Command</b>	:TRACe[1] 2 3:APD:UPDate[:STATe] ON OFF 0 1 :TRACe[1] 2 3:APD:UPDate[:STATe]?
<b>Example</b>	:TRAC2:APD:UPD 0 Makes trace 2 inactive (stops updating)
Couplings	Whenever you set Update to On for any trace, the Display is set to On for that trace.
Preset	1 0 0 (On for Trace 1; Off for Trace 2 and 3)
State Saved	Saved in Instrument State
Initial S/W Revision	A.13.00

### Trace Display State (Remote Command Only)

Toggle the trace display state.

Key Path	Trace/Detector
<b>Remote Command</b>	:TRACe[1] 2 3:APD:DISPlay[:STATe] ON OFF 0 1 :TRACe[1] 2 3:APD:DISPlay[:STATe]?
<b>Example</b>	:TRAC2:APD:DISP,1 Makes trace 2 visible :TRAC3:APD:DISP,0 Blanks trace 3
Couplings	Whenever you set Update to On for any trace, the Display is set to On for that trace.
Preset	1 0 0 (On for Trace 1; Off for Trace 2 and Trace 3)
State Saved	Saved in instrument state.
Initial S/W Revision	A.13.00

### Reset Exceeded Limit

Resets the Exceeded Limit Trace.

Key Path	Trace/Detector
<b>Remote Command</b>	[:SENSe]:APD:TRACe:ELIMit:RESet
<b>Example</b>	APD:TRAC:ELIM:RES
Initial S/W Revision	A.13.00

## Query Trace Data (Remote Command Only)

This command allows trace data to be sent to the instrument or queried from the instrument. The response to the query is a list of trace data in the pair of x,y. x is the disturbance level returned in the amplitude unit currently selected. Y is the probability of time.

The traces in the APD contain 1024 points each.

<b>Remote Command</b>	:TRACe:APD[:DATA]? MEAS MEAS2 ELIMit
<b>Example</b>	TRAC:APD? MEAS2 Queries the analyzer for the contents of Measured 2 trace.
<b>Remote Command Notes</b>	When MEAS, the latest contents of Measured trace will be returned. When MEAS2, the latest contents of Measured 2 trace will be returned. When ELIM, the latest contents of Exceeded Limit trace will be returned.
<b>Couplings</b>	The FORMat:DATA command describes the different types of data formats that can be used with trace data. When the numeric data format is REAL or ASCii, x data is output in the current Y Axis unit. When the data format is INTeger, x data is output in units of m dBm (.001 dBm) and y data is output in the units of m. Use the FORMat:BORDER command to set the byte order.
<b>Backwards Compatibility SCPI</b>	:TRACe[:DATA]? TRACE1 TRACE2 TRACE3
<b>Backwards Compatibility SCPI Notes</b>	This command is included for ESU compatibility. The SCPI is Meas Local and Context Sensitive.
<b>Initial S/W Revision</b>	A.13.00

## Trigger

See ["Trigger" on page 358](#)

### Free Run

See ["Free Run " on page 365](#)

### Video

See ["Video \(IF Envelope\) " on page 366](#)

### Trigger Level

See ["Trigger Level " on page 366](#)

### Trig Slope

See ["Trig Slope " on page 367](#)

### Trig Delay

See ["Trig Delay " on page 368](#)

### External 1

See ["External 1 " on page 369](#)

### Trigger Level

See ["Trigger Level " on page 370](#)

### Trig Slope

See ["Trig Slope " on page 370](#)

### Trig Delay

See ["Trig Delay " on page 371](#)

### Zero Span Delay Comp

See ["Zero Span Delay Comp On/Off" on page 372](#)

### External 2

See ["External 2 " on page 372](#)

### Trigger Level

See ["Trigger Level " on page 373](#)

### Trig Slope

See ["Trig Slope " on page 373](#)

### **Trig Delay**

See "Trig Delay " on page 374

### **Zero Span Delay Comp**

See "Zero Span Delay Comp On/Off" on page 374

### **Auto/Holdoff**

See "Auto/Holdoff " on page 375

### **Auto Trig**

See "Auto Trig " on page 375

### **Trig Holdoff**

See "Trig Holdoff " on page 376

## User Preset

Accesses a menu that gives you the following three choices:

- User Preset – recalls a state previously saved using the Save User Preset function.
- User Preset All Modes – presets all of the modes in the analyzer
- Save User Preset– saves the current state for the current mode

Key Path	Front-panel key
Backwards Compatibility Notes	<p>User Preset is actually loading a state, and in legacy analyzers, it was possible to load a state without affecting the trace data, limit lines or correction data. Similarly it was possible to do a User Preset without affecting the trace data, limit lines or correction data.</p> <p>In the X-Series, “state” always includes all of this data; so whenever state is loaded, or User Preset is executed, all of the traces, limit lines and corrections are affected. Although this differs from previous behavior, it is desirable behavior, and should not cause adverse issues for users.</p> <p>On ESA and PSA, User Preset affected the entire instrument’s state. In the X-Series, User Preset only recalls the state for the active mode. There is a User Preset file for each mode. User Preset can never cause a mode switch as it can in legacy analyzers. If you want to recall all modes to their user preset file state, you will need to do a User Preset after mode switching into each mode.</p> <p>User Preset recalls mode state which can now include data like traces; whereas on ESA and PSA, User Preset did not affect data.</p>
Initial S/W Revision	Prior to A.02.00

## User Preset

User Preset sets the state of the currently active mode back to the state that was previously saved for this mode using the Save User Preset menu key or the SCPI command, SYST:PRES:USER:SAV. It not only recalls the Mode Preset settings, but it also recalls all of the mode persistent settings, and the Input/Output system setting that existed at the time Save User Preset was executed.

If a Save User Preset has not been done at any time, User Preset recalls the default user preset file for the currently active mode. The default user preset files are created if, at power-on, a mode detects there is no user preset file. There will never be a scenario when there is no user preset file to restore. For each mode, the default user preset state is the same state that would be saved if a Save User Preset is performed in each mode right after doing a Restore Mode Default and after a Restore Input/Output Defaults.

The User Preset function does the following:

- Aborts the currently running measurement.
- Sets the mode State to the values defined by Save User Preset.
- Makes the saved measurement for the currently running mode the active measurement.
- Brings up the saved menu for the power-on mode.
- Clears the input and output buffers.
- Sets the Status Byte to 0.

Key Path	User Preset
<b>Remote Command</b>	:SYSTem:PRESet:USER
<b>Example</b>	:SYST:PRES:USER:SAVE:SYST:PRES:USER
Notes	:SYST:PRES:USER:SAVE is used to save the current state as the user preset state. Clears all pending OPC bits. The Status Byte is set to 0. Pressing the User Preset front-panel key while already in the User Preset menu will cause the User Preset to get executed
Couplings	A user preset will cause the currently running measurement to be aborted and cause the saved measurement to be active. Recalling a User Preset file has the same issues that recalling a Save State file has. Some settings may need to be limited and therefore re-coupled, since the capabilities of the mode may have changes when the User Preset file was last saved.
Initial S/W Revision	Prior to A.02.00

## User Preset All Modes

Recalls all of the User Preset files for each mode, switches to the power-on mode, and activates the saved measurement from the power-on mode User Preset file.

### NOTE

When the instrument is secured, all of the user preset files are converted back to their default user preset files.

The User Preset function does the following:

- Aborts the currently running measurement.
- Switches the Mode to the power-on mode.
- Restores the User Preset files for each mode.
- Makes the saved measurement for the power-on mode the active measurement.
- Brings up the saved menu for the power-on mode.
- Clears the input and output buffers.
- Sets the Status Byte to 0.

Key Path	User Preset
<b>Remote Command</b>	:SYSTem:PRESet:USER:ALL
<b>Example</b>	:SYST:PRES:USER:SAVE:SYST:PRES:USER:ALL
Notes	Clears all pending OPC bits. The Status Byte is set to 0. :SYST:PRES:USER:SAVE is used to save the current state as the user preset state.
Couplings	A user preset will cause the currently running measurement to be aborted, cause a mode switch to the power-on mode, and cause the saved measurement to be active in the power-on mode. Recalling a User Preset file has the same issues that recalling a Save State file has. Some settings may need to be limited and therefore re-coupled, since the capabilities of the mode may have changes when the User Preset file was last saved.
Initial S/W Revision	Prior to A.02.00

## Save User Preset

Saves the currently active mode and its State. You can recall this User Preset file by pressing the User Preset menu key or sending the SYST:PRES:USER remote command. This same state is also saved by the Save State function.

Key Path	User Preset
Remote Command	:SYSTem:PRESet:USER:SAVE
Example	:SYST:PRES:USER:SAVE
Notes	:SYST:PRES:SAVE creates the same file as if the user requested a *SAV or a MMEM:STOR:STAT, except User Preset Save does not allow the user to specify the filename or the location of the file.
Initial S/W Revision	Prior to A.02.00



## View/Display

The View/Display key opens the Display Menu (common to most measurements) and the View menu for the current measurement.

Some measurements have simple View menus, or even no View menu, others provide many different Views.

Views are different ways of looking at data, usually different ways of looking at the same data, often when the data represents a time record that is being digitally processed with an FFT and/or other digital signal processing algorithms.

Key Path	Front-panel key
Initial S/W Revision	Prior to A.02.00

## Display

The Display menu is common to most measurements, and is used for configuring items on the display. Some Display menu settings apply to all the measurements in a mode, and some only to the current measurement. Those under the System Display Settings key apply to all measurements in all modes.

Key Path	Display
Key Path	View/Display
Initial S/W Revision	Prior to A.02.00

## Annotation

Turns on and off various parts of the display annotation. The annotation is divided up into four categories:

1. Meas Bar: This is the measurement bar at the top of the screen. It does not include the settings panel or the Active Function. Turning off the Meas Bar turns off the settings panel and the Active Function. When the Meas Bar is off, the graticule area expands to fill the area formerly occupied by the Meas Bar.
2. Screen Annotation: this is the annotation and annunciation around the graticule, including any annotation on lines (such as the display line, the threshold line, etc.) This does NOT include the marker number or the N dB result. When off, the graticule expands to fill the entire graticule area.
3. Trace annotation: these are the labels on the traces, showing their detector (or their math mode).
4. Active Function annotation: this is the active function display in the meas bar, and all of the active function values displayed on softkeys.

See the figure below. Each type of annotation can be turned on and off individually.

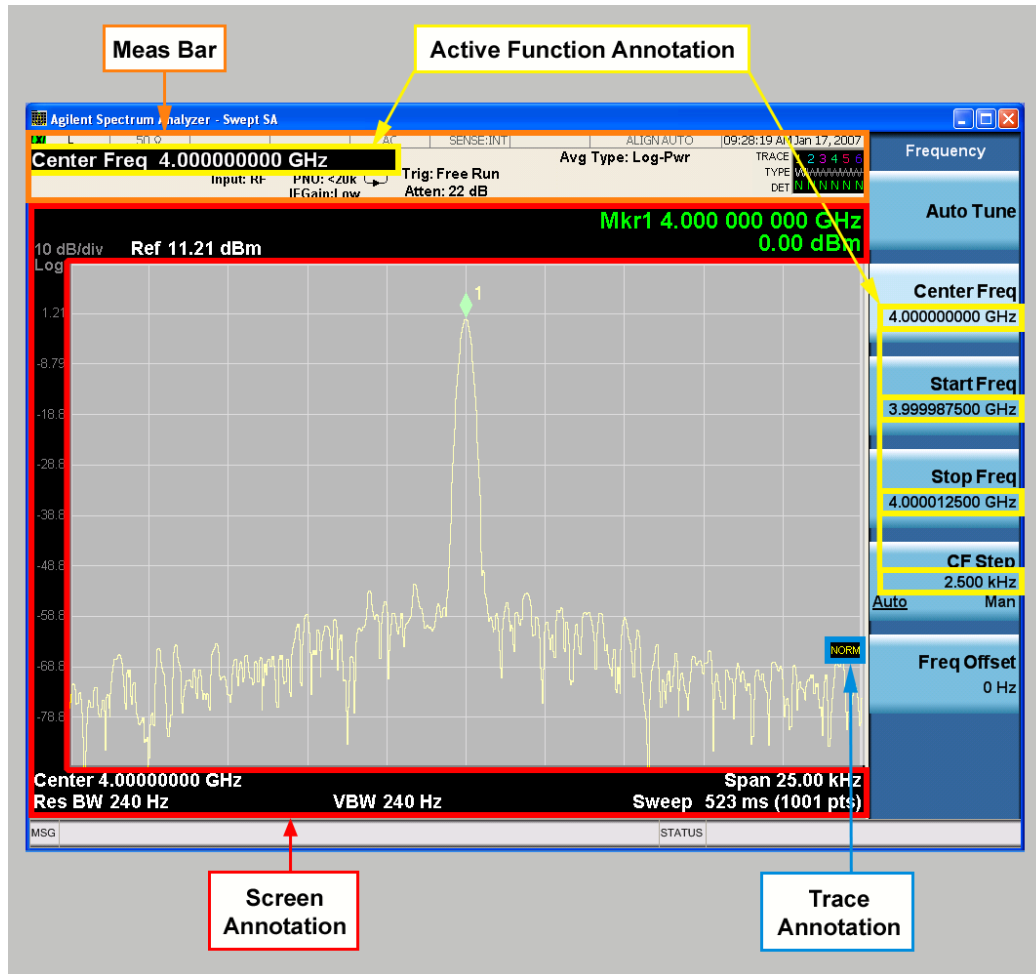

Key Path	View/Display, Display
Initial S/W Revision	Prior to A.02.00

**Meas Bar On/Off**

This function turns the Measurement Bar on and off, including the settings panel. When off, the graticule area expands to fill the area formerly occupied by the Measurement Bar.

Key Path	View/Display, Display, Annotation
Remote Command	:DISPlay:ANNOtation:MBAR[:STATe] OFF ON 0 1 :DISPlay:ANNOtation:MBAR[:STATe]?
Example	DISP:ANN:MBAR OFF
Dependencies	Grayed out and forced to OFF when System Display Settings, Annotation is set to Off.
Preset	On This should remain Off through a Preset when System DisplaySettings, Annotation is set to Off.
State Saved	Saved in instrument state.
Initial S/W Revision	Prior to A.02.00

## Screen

This controls the display of the annunciation and annotation around the graticule, including any annotation on lines (such as the display line, the threshold line, etc.) and the y-axis annotation. This does NOT include marker annotation (or the N dB result). When off, the graticule expands to fill the entire graticule area, leaving only the 1.5% gap above the graticule as described in the Trace/Detector chapter.

Key Path	View/Display, Display, Annotation
<b>Remote Command</b>	:DISPlay:ANNotation:SCReen[:STATe] OFF ON 0 1 :DISPlay:ANNotation:SCReen[:STATe]?
<b>Example</b>	DISP:ANN:SCR OFF
Dependencies	Grayed-out and forced to OFF when System Display Settings, Annotation is set to Off.
Preset	On This should remain Off through a Preset when System DisplaySettings, Annotation is set to Off
State Saved	Saved in instrument state.
Initial S/W Revision	Prior to A.02.00

## Trace

Turns on and off the labels on the traces, showing their detector (or their math mode) as described in the Trace/Detector section.

If trace math is being performed with a trace, then the trace math annotation will replace the detector annotation.

Key Path	View/Display, Display, Annotation
<b>Remote Command</b>	:DISPlay:ANNotation:TRACe[:STATe] ON OFF 1 0 :DISPlay:ANNotation:TRACe[:STATe]?
<b>Example</b>	DISP:ANN:TRAC OFF
Preset	Off
State Saved	Saved in instrument state.
Initial S/W Revision	Prior to A.02.00

## Active Function Values On/Off

Turns on and off the active function display in the Meas Bar, and all of the active function values displayed on the softkeys.

Note that all of the softkeys that have active functions have these numeric values blanked when this function is on. This is a security feature..

11 APD Measurement  
View/Display

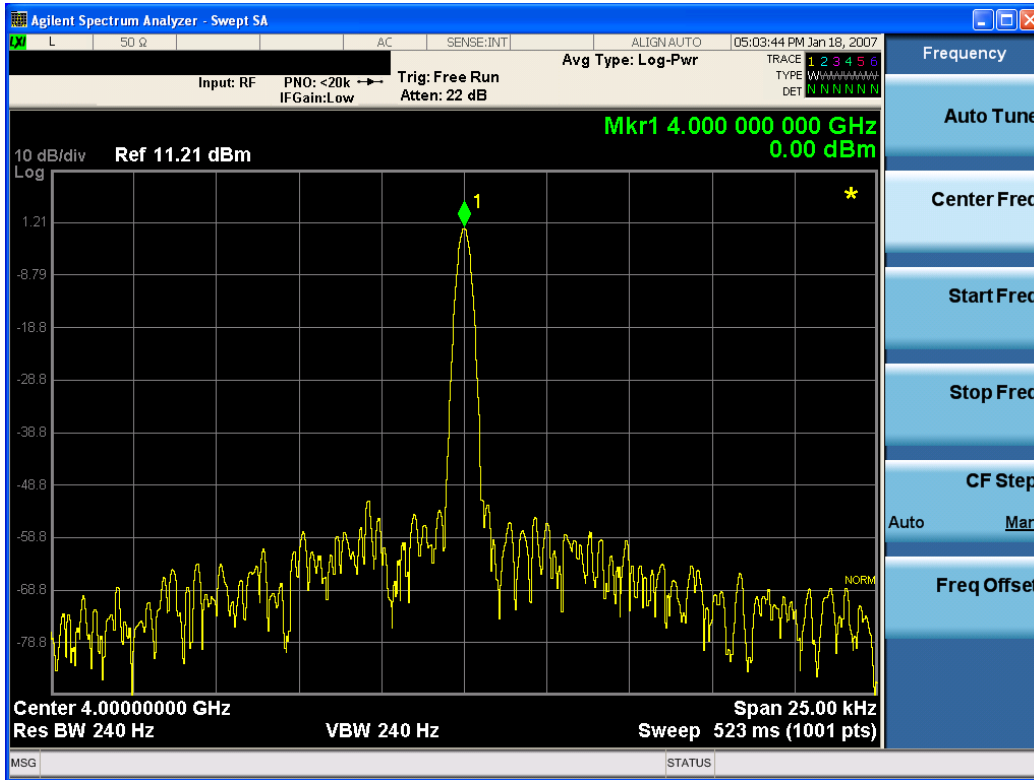

Key Path	View/Display, Display, Annotation
Remote Command	:DISPlay:ACTivefunc[:STATE] ON OFF 1 0 :DISPlay:ACTivefunc[:STATE]?
Example	DISP:ACT OFF
Dependencies	Grayed out and forced to OFF when System Display Settings, Annotation is set to Off.
Preset	On This should remain Off through a Preset when System DisplaySettings, Annotation is set to Off
State Saved	Saved in instrument state.
Initial S/W Revision	Prior to A.02.00

Title

Displays menu keys that enable you to change or clear a title on your display.

Key Path	View/Display, Display
Initial S/W Revision	Prior to A.02.00

Change Title

Writes a title into the "measurement name" field in the banner, for example, "Swept SA".

Press Change Title to enter a new title through the alpha editor. Press Enter or Return to complete the entry. Press ESC to cancel the entry and preserve your existing title.

The display title will replace the measurement name. It remains for this measurement until you press Change Title again, or you recall a state, or a Preset is performed. A title can also be cleared by pressing Title, Clear Title.

**NOTE**

Notice the inclusion of the <measurement> parameter in the command below. Because each measurement remembers the Display Title, the command must be qualified with the measurement name. For the Swept SA measurement this is not the case; no <measurement> parameter is used when changing the Display Title for the Swept SA measurement.

Key Path	View/Display, Display, Title
Mode	All
<b>Remote Command</b>	:DISPlay:<measurement>:ANNotation:TITLe:DATA <string> :DISPlay:<measurement>:ANNotation:TITLe:DATA?
<b>Example</b>	DISP:ANN:TITL:DATA "This Is My Title" This example is for the Swept SA measurement in the Spectrum Analyzer mode. The SANalyzer <measurement> name is not used. DISP:ACP:ANN:TITL:DATA "This Is My Title" This example is for Measurements other than Swept SA. Both set the title to: This Is My Title
Notes	Pressing this key cancels any active function. When a title is edited the previous title remains intact (it is not cleared) and the cursor goes at the end so that characters can be added or BKSP can be used to go back over previous characters.
Preset	No title (measurement name instead)
State Saved	Saved in instrument state.
Initial S/W Revision	Prior to A.02.00

### Clear Title

Clears a title from the front-panel display. Once cleared, the title cannot be retrieved. After the title is cleared, the current Measurement Name replaces it in the title bar.

Key Path	View/Display, Display, Title
<b>Example</b>	The following commands clear the title and restore the measurement's original title: DISP:ANN:TITL:DATA "" This example is for the Swept SA measurement in the Spectrum Analyzer mode. The SANalyzer <measurement> name is not used. DISP:ACP:ANN:TITL:DATA "" This example is for ACP; in measurements other than Swept SA the measurement name is required.
Notes	Uses the :DISPlay:<measurement>:ANNotation:TITLe:DATA <string> command with an empty string (in the Swept SA, the <measurement> is omitted).
Preset	Performed on Preset.
Initial S/W Revision	Prior to A.02.00

## Graticule

Pressing Graticule turns the display graticule On or Off. It also turns the graticule y-axis annotation on and off.

Key Path	View/Display, Display
Remote Command	:DISPlay:WINDow[1]:TRACe:GRATicule:GRID[:STATe] OFF ON 0 1 :DISPlay:WINDow[1]:TRACe:GRATicule:GRID[:STATe]?
Example	DISP:WIND:TRAC:GRAT:GRID OFF
Notes	The graticule is the set of horizontal and vertical lines that make up the grid/divisions for the x-axis and y-axis.
Preset	On
State Saved	Saved in instrument state
Initial S/W Revision	Prior to A.02.00

## System Display Settings

These settings are "Mode Global" – they affect all modes and measurements and are reset only by Restore Misc Defaults or Restore System Defaults under System.

Key Path	View/Display, Display
Initial S/W Revision	Prior to A.02.00

## Annotation Local Settings

This is a Mode Global override of the meas local annotation settings. When it is All Off, it forces ScreenAnnotation, Meas Bar, Trace, and Active Function Values settings to be OFF for all measurements in all modes. This provides the security based "annotation off" function of previous analyzers; hence it uses the legacy SCPI command.

When it is All Off, the Screen, Meas Bar, Trace, and Active Function Values keys under the Display, Annotation menu are grayed out and forced to Off. When Local Settings is selected, you are able to set the local annotation settings on a measurement by measurement basis.

Key Path	View/Display, Display, System Display Settings
Remote Command	:DISPlay:WINDow[1]:ANNotation[:ALL] OFF ON 0 1 :DISPlay:WINDow[1]:ANNotation[:ALL]?
Example	:DISP:WIND:ANN OFF
Preset	On (Set by Restore Misc Defaults)
State Saved	Not saved in instrument state.
Backwards Compatibility Notes	The WINDow parameter and optional subopcode is included for backwards compatibility but ignored – all windows are equally affected.
Initial S/W Revision	Prior to A.02.00

## Themes

Accesses a menu of functions that enable you to choose the theme to be used when saving the screen image.

The **Themes** option is the same as the **Themes** option under the **Display** and **Page Setup** dialogs. It allows you to choose between themes to be used when saving the screen image.

<b>Key Path</b>	Save, Screen Image
<b>Remote Command</b>	:MMEMory:STORe:SCReen:THEMe TDColor   TDMonochrome   FCOLOR   FMONochrome  :MMEMory:STORe:SCReen:THEMe?
<b>Example</b>	:MMEM:STOR:SCR:THEM TDM
<b>Preset</b>	3D Color; Is not part of Preset, but is reset by Restore Misc Defaults or Restore System Defaults All and survives subsequent running of the modes.
<b>Readback</b>	3D Color   3D Mono   Flat Color   Flat Mono
<b>Backwards Compatibility Notes</b>	In ESA and PSA we offer the choice of "Reverse Bitmap" or "Reverse Metafile" when saving screen images. This is much like the "Flat Color" theme available in X-Series. Also, if you selected Reverse Bitmap AND a black & white screen image, that would be much like "Flat Monochrome". In other words, each of the X-Series themes has a similar screen image type in ESA/PSA. But they are not identical.
<b>Initial S/W Revision</b>	Prior to A.02.00

### 3D Color

Selects a standard color theme with each object filled, shaded and colored as designed.

<b>Key Path</b>	Save, Screen Image, Themes
<b>Example</b>	MMEM:STOR:SCR:THEM TDC
<b>Readback</b>	3D Color
<b>Initial S/W Revision</b>	Prior to A.02.00

### 3D Monochrome

Selects a format that is like 3D color but shades of gray are used instead of colors.

<b>Key Path</b>	Save, Screen Image, Themes
<b>Example</b>	MMEM:STOR:SCR:THEM TDM
<b>Readback</b>	3D Mono
<b>Initial S/W Revision</b>	Prior to A.02.00

### Flat Color

Selects a format that is best when the screen is to be printed on an ink printer.

Key Path	Save, Screen Image, Themes
<b>Example</b>	MMEM:STOR:SCR:THEM FCOL
Readback	Flat Color
Initial S/W Revision	Prior to A.02.00

### Flat Monochrome

Selects a format that is like Flat Color. But only black is used (no colors, not even gray), and no fill.

Key Path	Save, Screen Image, Themes
<b>Example</b>	MMEM:STOR:SCR:THEM FMON
Readback	Flat Mono
Initial S/W Revision	Prior to A.02.00

### Backlight

Accesses the display backlight on/off keys. This setting may interact with settings under the Windows "Power" menu.

When the backlight is off, pressing ESC, TAB, SPACE, ENTER, UP, DOWN, LEFT, RIGHT, DEL, BKSP, CTRL, or ALT turns the backlight on without affecting the application. Pressing any other key will turn backlight on and could potentially perform the action as well.

Key Path	View/Display, Display, System Display Settings
<b>Remote Command</b>	:DISPlay:BACKlight ON OFF :DISPlay:BACKlight?
Preset	ON (Set by Restore Misc Defaults)
Initial S/W Revision	Prior to A.02.00

### Backlight Intensity

An active function used to set the backlight intensity. It goes from 0 to 100 where 100 is full on and 0 is off. This value is independent of the values set under the Backlight on/off key.

Key Path	View/Display, Display, System Display Settings
<b>Remote Command</b>	:DISPlay:BACKlight:INTensity <integer> :DISPlay:BACKlight:INTensity?
<b>Example</b>	DISP:BACK:INT 50



Preset	100 (Set by Restore Misc Defaults)
Min	0
Max	100
Initial S/W Revision	Prior to A.02.00



## 12 Disturbance Analyzer Measurement

The Disturbance Analyzer measurement is used for automatic assessment of amplitude, rate and duration of disturbances and is commonly used for household appliances in electromagnetic compatibility test. The Disturbance Analyzer measurement has Peak and Quasi Peak detector traces. The traces measured values are gapless with 500  $\mu$ s resolution time. The maximum duration of recorded traces data is 2 hours. CISPR 16-1-1 chapter 9 and CISPR 14-1 define the standards of the test methods of the measurement and the process of test result interpretation. However, the Click measurement and analysis are not clearly described in CISPR standard. The Disturbance Analyzer measurement is designed based on an interpretation of the CISPR standards.

This topic contains the following sections:

Measurement Commands for Disturbance Analyzer

["Remote Command Results for Disturbance Analyzer" on page 1029](#)

## Measurement Commands for Disturbance Analyzer

CONFigure:DANalyzer

CONFigure:DANalyzer:NDEFault

CONFigure?

INITiate:DANalyzer

FETCh:DANalyzer [n]?

MEASure:DANalyzer [n]?

READ:DANalyzer [n]?

## Remote Command Results for Disturbance Analyzer

Command	n	Return Value
INITiate:DANalyzer	n/a	n/a
CONFigure?	n/a	Name of current measurement: "DANalyzer"
CONFigure:DANalyzer	n/a	n/a (selects DAN measurement in Meas Preset state)
CONFigure:DANalyzer:NDEFault	n/a	n/a (selects DAN measurement without affecting settings)
FETCh:DANalyzer[n]? MEASure:DANalyzer[n]? READ:DANalyzer[n]?	not specified or n=1	Returns comma separated list containing detailed information in the following format: <ul style="list-style-type: none"> <li>• Time Remaining</li> <li>• Counted Clicks</li> <li>• Click Rate</li> <li>• Lq</li> <li>• Clicks &gt; Lq</li> <li>• Counted Continuous Disturbance</li> <li>• Total Time of Continuous Disturbance</li> </ul>
	2	Returns comma separated list containing detailed information in the following format: <ul style="list-style-type: none"> <li>• Number of disturbance in the following list (integer)</li> </ul> [Repeat the following for each disturbance] <ul style="list-style-type: none"> <li>• Disturbance#</li> <li>• Duration of Disturbance</li> <li>• Peak Amplitude</li> <li>• Quasi Peak Amplitude</li> </ul>
	3	Returns comma separated list containing detailed information in the following format: <ul style="list-style-type: none"> <li>• Frequency</li> <li>• Measurement Duration</li> <li>• Click Rate</li> <li>• Click &lt; 10ms</li> <li>• Click &lt;= 10ms</li> <li>• Click ( &gt;10ms – 20ms )</li> <li>• Click &gt; 20ms</li> <li>• Click &gt; Lq</li> <li>• Click &gt; Lq ( Percent )</li> <li>• L</li> <li>• Lq</li> <li>• Counted Continuous Disturbance</li> <li>• Total Time of Continuous Disturbance</li> <li>• Exception Rule Used : 600ms Combination</li> <li>• Exception Rule Used : Separation of Click &lt; 200ms</li> </ul>

Command	n	Return Value
		<ul style="list-style-type: none"><li>• Overload Occurred</li><li>• Result</li></ul>
	4	Returns Peak amplitude trace data as a series of x,y pairs
	5	Returns Quasi Peak amplitude trace data as a series of x,y pairs

Key Path	Meas
Initial S/W Revision	A.14.00

## AMPTD Y Scale

Accesses a menu that enables you to control the amplitude parameters.

Key Path	Front-panel key
Notes	. Front panel only.
Initial S/W Revision	A.14.00

### Reference Level

Specifies the amplitude represented by the topmost graticule line.

Key Path	AMPTD/Y Scale
<b>Remote Command</b>	:DISPlay:DANalyzer:VIEW[1]:WINDow[1]:TRACe:Y[:SCALe]:RLEVel <real> :DISPlay:DANalyzer:VIEW[1]:WINDow[1]:TRACe:Y[:SCALe]:RLEVel?
<b>Example</b>	DISP:DAN:VIEW:WIND:TRAC:Y:RLEV 80 dBuV DISP:DAN:VIEW:WIND:TRAC:Y:RLEV?
Couplings	Ref level is always auto coupled to limit so that limit line is always in the center of graph.
Preset	106.99 dBuV
State Saved	Saved in instrument state
Min	RefLevelMin = -63.01 dBuV + RefLevelOffset - ExtGain.
Max	RefLevelMax = 206.99 dBuV + RefLevelOffset - ExtGain
Default Unit	Depends on the current selected Y axis unit
Initial S/W Revision	A.14.00

### Scale/ Div

Specifies the units per division of vertical scale in logarithmic display.

Key Path	AMPTD Y Scale
<b>Remote Command</b>	:DISPlay:DANalyzer:VIEW[1]:WINDow[1]:TRACe:Y[:SCALe]:PDIVision <rel_ amptd> :DISPlay:DANalyzer:VIEW[1]:WINDow[1]:TRACe:Y[:SCALe]:PDIVision?
<b>Example</b>	DISP:DAN:VIEW:WIND:TRAC:Y:PDIV 5 dB DISP:DAN:VIEW:WIND:TRAC:Y:PDIV?
Preset	10.00 dB
State Saved	Saved in instrument state
Min	0.10 dB
Max	20.00 dB
Initial S/W Revision	A.14.00





## Auto Couple

The Auto Couple feature provides a quick and convenient way to automatically couple multiple instrument settings. This helps ensure accurate measurements and optimum dynamic range. When the Auto Couple feature is activated, either from the front panel or remotely, all parameters of the current measurement that have an Auto/Manual mode are set to Auto mode and all measurement settings dependent on (or coupled to) the Auto/Man parameters are automatically adjusted for optimal performance.

For the Disturbance Analyzer measurement, these parameters are:

- Reference Level
- Attenuation
- Step Frequency
- RBW

---

Key Path	Front-panel key
----------	-----------------

---

## BW

BW controls are not settable by the user and therefore do not appear in any menus. A blank menu appears when this key is pressed.

---

Key Path	Front-panel key
----------	-----------------

---

## Cont

There is no Cont Mode in the Disturbance Analyzer measurement. Pressing the Cont key will show error message “Settlings conflict; Cont Mode is not available”.

---

Key Path	Front Panel Key
Initial S/W Revision	A.14.00

---

12 Disturbance Analyzer Measurement  
File

File

See "File" on page 266

## FREQ Channel

The Frequency menu is in the **Error! Reference source not found.** menu in the Disturbance Analyzer measurement.

---

Key Path	Front-panel key
Initial S/W Revision	A.14.00

---

## Input/Output

See ["Input/Output" on page 150](#)

## Marker

Access the Marker menu. The functions in this menu include a 1-of-N selection of the control mode Normal, Delta or Off for the selected marker. If the selected marker is Off, pressing Marker sets it to Normal and places it at the center of the screen on the trace determined by the Marker Trace rules. At the same time, the reference value of the selected marker appears on the Active Function area.

The marker X axis value entered in the active function area will display the marker value to its full entered precision.

<b>Key Path</b>	Front-panel key
<b>Remote Command</b>	:CALCulate:DANalyzer:MARKer[1] 2 ... 12:MODE POSition   DELTa   OFF :CALCulate:DANalyzer:MARKer[1] 2 ... 12:MODE?
<b>Example</b>	CALC:DAN:MARK:MODE OFF CALC:DAN:MARK:MODE?
<b>Notes</b>	If the selected marker is Off, pressing Marker sets it to Normal and places it at the center of the screen on the trace determined by the Marker Trace rules. At the same time, the Marker X Axis Value appears in the Active Function area.  Default Active Function: the active function for the selected marker's current control mode. Note that if the current control mode is Off, there is no active function and the active function is turned off.  Active Function Display: the marker X axis value entered in the active function area will display the marker value to its fully entered precision.
<b>Preset</b>	OFF
<b>State Saved</b>	Saved in instrument state
<b>Initial S/W Revision</b>	A.14.00

## Select Marker

Displays a menu with 12 markers available for selection.

<b>Key Path</b>	Marker
<b>Notes</b>	Front panel only. The selected marker is remembered even when not in the Marker menu and is used
<b>Preset</b>	Marker 1
<b>State Saved</b>	Saved in instrument state
<b>Initial S/W Revision</b>	A.14.00

## Normal

Sets the control mode for the selected marker to Normal and turns on the active function for setting its value. If the selected marker was off, it is placed at the center of the screen on the trace specified by the marker's Trace attribute.

A Normal mode (POSition type) marker can be moved to any point on the X Axis by specifying its X Axis value. Its absolute Y Axis value is then the value of the trace point at that X Axis value.

Key Path	Marker
<b>Example</b>	CALC:DAN:MARK:MODE POS Sets Marker 1 to Normal.
Couplings	The marker addressed by this command becomes the selected marker on the front panel.
State Saved	Saved in instrument state
Initial S/W Revision	A.14.00

## Delta

Sets the control mode for the selected marker to Delta and turns on the active function for setting its delta value. If the selected marker is off, the marker is placed at the center of the screen on the trace specified by the marker's Trace attribute.

In Delta mode the marker result shows the relative result between the selected (Delta) marker and its reference marker. A delta marker can be moved to any point on the X Axis by specifying its X Axis offset from a reference marker. Its absolute Y Axis value is then the value of the trace point at that X Axis value.

Key Path	Marker
<b>Example</b>	CALC:DAN:MARK:MODE DELT Sets marker 1 to Delta.
Dependencies	The marker addressed by this command becomes the selected marker on the front panel.
State Saved	Saved in instrument state
Initial S/W Revision	A.14.00

## Off

Turns off the selected marker. Removes the marker annunciation from the display. Turns off any active function. Turning the marker off does not affect which marker is selected.

Key Path	Marker
<b>Example</b>	CALC:DAN:MARK:MODE OFF Sets Marker 1 to Off.
State Saved	Saved in instrument state
Initial S/W Revision	A.14.00

## Select Marker

Displays a menu with 12 markers available for selection.

Key Path	Marker
Notes	Front panel only. The selected marker is remembered even when not in the Marker menu and is used



Preset	Marker 1
State Saved	The number of the selected marker is saved in instrument state.
Initial S/W Revision	A.14.00

## Select Marker

Display a menu with 12 markers available for selection for the current measurement.

Key Path	Marker
Notes	Front panel only. The selected marker is remembered even when not in the Marker menu and is used
Preset	Marker 1
State Saved	The number of the selected marker is saved in instrument state.
Initial S/W Revision	A.07.00

## Relative To

Select the reference marker for a marker in Delta mode.

Key Path	Marker, Properties
<b>Remote Command</b>	:CALCulate:DANalyzer:MARKer[1] 2 ... 12:REFerence <integer> :CALCulate:DANalyzer:MARKer[1] 2 ... 12:REFerence?
<b>Example</b>	CALC:DAN:MARK5:REF 1 CALC:DAN:MARK5:REF?
Notes	A marker cannot be relative to itself so that choice is grayed out, and if sent from SCPI, generates error -221: "Settings conflict; marker cannot be relative to itself." When queried, a single value will be returned - the specified marker number's relative marker.
Preset	2
State Saved	Saved in instrument state
Min	1
Max	12
Initial S/W Revision	A.14.00

## Marker Trace

Assign the specified marker to the designated trace.

Key Path	Marker, Properties
<b>Remote Command</b>	:CALCulate:DANalyzer:MARKer[1] 2 ... 12:TRACe 1 2

	:CALCulate:DANalyzer:MARKer[1] 2 ... 12:TRACe?
<b>Example</b>	CALC:DAN:MARK1:TRAC 1
<b>Notes</b>	A marker may be placed on a blanked and/or inactive trace, even though the trace is not visible and/or updating. An application may register a trace name to be displayed on the key instead of a trace number.
<b>Couplings</b>	The state of Marker Trace is not affected by the Auto Couple key. If a Marker Trace is chosen manually, Auto Init goes to Off for that marker. Sending the remote command causes the addressed marker to become selected.
<b>Preset</b>	1
<b>State Saved</b>	The Marker Trace and state of Auto Init for each marker is saved in instrument state.
<b>Min</b>	1
<b>Max</b>	2
<b>Readback line</b>	[TraceN, Auto Init] or [TraceN, Manual] where N is the trace number to which the marker is currently assigned.
<b>Initial S/W Revision</b>	A.14.00

### Couple Marker

When this function is invoked, moving any marker causes an “equal X Axis movement” of every other marker that is active. By “equal X Axis movement” we mean that the difference between each marker’s X Axis value (in the fundamental x-axis units of the trace that marker is on) is preserved, as is the X Axis value of the marker being moved (in the same fundamental X-axis units).

**NOTE** This may result in markers going off screen.

<b>Key Path</b>	Marker
<b>Remote Command</b>	:CALCulate:DANalyzer:MARKer:COUPle[:STATe] ON OFF 1 0 :CALCulate:DANalyzer:MARKer:COUPle[:STATe]?
<b>Example</b>	CALC:DAN:MARK:COUP ON CALC:DAN:MARK:COUP?
<b>Preset</b>	OFF
<b>State Saved</b>	Saved in instrument state
<b>Initial S/W Revision</b>	A.14.00

### All Marker Off

Turns all markers Off.

<b>Key Path</b>	Marker
<b>Remote Command</b>	:CALCulate:DANalyzer:MARKer:AOFF

<b>Example</b>	:CALC:DAN:MARK:AOFF
Couplings	Sets the selected marker to 1.
Initial S/W Revision	A.14.00

### Marker X Axis Value (Remote Command Only)

Sets the marker X Axis value in the current marker X Axis Scale unit. It has no effect if the control mode is Off, but is the SCPI equivalent of entering an X value, if the control mode is Normal or Delta.

<b>Key Path</b>	Marker, Select Marker
<b>Remote Command</b>	:CALCulate:DANalyzer:MARKer[1] 2 ... 12:X <real> :CALCulate:DANalyzer:MARKer[1] 2 ... 12:X?
<b>Example</b>	CALC:DAN:MARK3:X 0 CALC:DAN:MARK3:X?
<b>Notes</b>	If no suffix is sent, it will use the fundamental units for the current marker X Axis Scale. If a suffix is sent that does not match the current marker X Axis Scale unit, an "Invalid suffix" error will be generated.  The query returns the marker's absolute X Axis value if the control mode is Normal, or the offset from the marker's reference marker, if the control mode is Delta. The query is returned in the fundamental units for the current marker X Axis scale: seconds. If the marker is off the response is not a number (NAN).
Preset	9.91E+37
State Saved	No
Initial S/W Revision	A.14.00

### Marker Y Axis Value ( Remote Command Only )

Returns the marker Y Axis value in the current marker Y Axis unit.

<b>Remote Command</b>	:CALCulate:DANalyzer:MARKer[1] 2 ... 12:Y?
<b>Example</b>	CALC:DAN:MARK11:Y?
<b>Notes</b>	The query returns the marker Y-axis result. If the marker is Off the response is 9.91E+37
State Saved	No
Initial S/W Revision	A.14.00

## Marker Function

Accesses a menu of keys that allows you to do marker zoom related functions.

Key Path	Front-panel key
Notes	Front panel only.
Initial S/W Revision	A.14.00

## Marker Zoom

Marker zoom will show traces data to the entire graticule display by magnifying 10% of the current traces data on the selected marker.

Key Path	Marker Function
<b>Remote Command</b>	CALCulate: DANalyzer: MARKer [1]   2   ...   12: FUNCtion: ZOOM
<b>Example</b>	CALC:DAN:MARK1:FUNC:ZOOM
Notes	Command Only
Dependencies	Marker Zoom function is not available if the new traces range is out of limit of the Min value of x-scale/div after magnifying the traces
Couplings	The Ref Value and Scale/Div will be changed to accommodate the new span when disturbance zoom is executed.
Initial S/W Revision	A.14.00

## Marker Zoom Out

Marker zoom out will return the graticule display back to the previous marker zoom display range.

Key Path	Marker Function
<b>Remote Command</b>	CALCulate: DANalyzer: MARKer [1]   2   ...   12: FUNCtion: ZOOM: OUT
<b>Example</b>	CALC:DAN:MARK1:FUNC:ZOOM:OUT
Notes	Command Only
Dependencies	Marker Zoom Out key is not available if the Marker Zoom has not executed
Couplings	The Ref Value and Scale/Div will be changed to accommodate the new span when disturbance zoom is executed.
<b>Backwards Compatibility SCPI</b>	CALCulate: DANalyzer: MARKer [1]   2   ...   12: FUNCtion: PREVIOUS: ZOOM
Initial S/W Revision	A.14.00

## Marker Zoom Out Full

Marker Zoom Out Full will be restored back to the previous marker zoom range completely.

Key Path	Marker Function
<b>Remote Command</b>	CALCulate:DAAnalyzer:MARKer[1] 2 ... 12:FUNCTION:ZOOM:CLEar
<b>Example</b>	CALC:DAN:MARK1:FUNC:ZOOM:CLE
Dependencies	The Marker Zoom Out Full key is not available if Marker Zoom has not executed.
Couplings	The Ref Value and Scale/Div will be changed to accommodate the new span when disturbance zoom is executed.
Initial S/W Revision	A.14.00

## MarkerMarker->

Displays a menu that enables you to access the Marker To function.

Key Path	Front-panel key
Notes	Front panel only.
Initial S/W Revision	A.14.00

## Mkr $\Delta$ ->Span

Sets the display graticule range to the values of the delta markers.

Key Path	Marker ->
<b>Remote Command</b>	:CALCulate:DANalyzer:MARKer[1] 2 ... 12[:SET]:DELTA:SPAN
<b>Example</b>	CALC:DAN:MARK2:DELT:SPAN
Dependencies	This function is only available when the selected marker is a delta marker. Otherwise the key is grayed out.
Initial S/W Revision	A.14.00

## Meas

The information in this section is common to all measurements. For key and remote command information for a specific measurement, refer to the section that describes the measurement of interest.

Measurements available under the Meas key are specific to the current Mode.

When viewing Help for measurements, note the following:

**NOTE**

Operation for some keys differs between measurements. The information displayed in Help pertains to the current measurement. To see how a key operates in a different measurement, exit Help (press the Cancel Esc key), select the measurement, then reenter Help (press the Help key) and press that key.

---

Key Path	Front-panel key
Initial S/W Revision	Prior to A.02.00

---

### Remote Measurement Functions

This section contains the following topics:

"Measurement Group of Commands" on page 1048

"Current Measurement Query (Remote Command Only)" on page 1050

"Limit Test Current Results (Remote Command Only)" on page 1050

"Data Query (Remote Command Only)" on page 1050

"Calculate/Compress Trace Data Query (Remote Command Only)" on page 1051

"Calculate Peaks of Trace Data (Remote Command Only)" on page 1056

Hardware-Accelerated Fast Power Measurement (Remote Command Only)

"Format Data: Numeric Data (Remote Command Only)" on page 1057

"Format Data: Byte Order (Remote Command Only)" on page 1058

---

Initial S/W Revision	Prior to A.02.00
----------------------	------------------

---

## Measurement Group of Commands

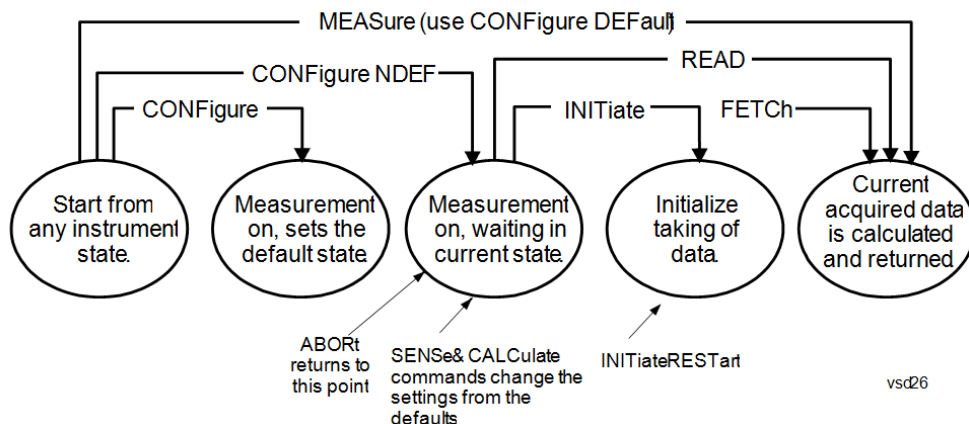

---

### Measure Commands:

:MEASure:<measurement>[n]?

This is a fast single-command way to make a measurement using the factory default instrument settings. These are the settings and units that conform to the Mode Setup settings (e.g. radio standard) that you have currently selected.

- Stops the current measurement (if any) and sets up the instrument for the specified measurement using the factory defaults
- Initiates the data acquisition for the measurement
- Blocks other SCPI communication, waiting until the measurement is complete before returning results.
- If the function does averaging, it is turned on and the number of averages is set to 10.
- After the data is valid it returns the scalar results, or the trace data, for the specified measurement. The type of data returned may be defined by an [n] value that is sent with the command.
- The scalar measurement results will be returned if the optional [n] value is not included, or is set to 1. If the [n] value is set to a value other than 1, the selected trace data results will be returned. See each command for details of what types of scalar results or trace data results are available.
- ASCII is the default format for the data output. (Older versions of Spectrum Analysis and Phase Noise mode measurements only use ASCII.) The binary data formats should be used for handling large blocks of data since they are smaller and faster than the ASCII format. Refer to the FORMat:DATA command for more information.

If you need to change some of the measurement parameters from the factory default settings you can set up the measurement with the CONFigure command. Use the commands in the SENSE:<measurement> and CALCulate:<measurement> subsystems to change the settings. Then you can use the READ? command to initiate the measurement and query the results.

If you need to repeatedly make a given measurement with settings other than the factory defaults, you can use the commands in the SENSE:<measurement> and CALCulate:<measurement> subsystems to set up the measurement. Then use the READ? command to initiate the measurement and query results.

Measurement settings persist if you initiate a different measurement and then return to a previous one. Use READ:<measurement>? if you want to use those persistent settings. If you want to go back to the default settings, use MEASure:<measurement>?.

---

### Configure Commands:

:CONFigure:<measurement>

This command stops the current measurement (if any) and sets up the instrument for the specified measurement using

---



---

the factory default instrument settings. It does not initiate the taking of measurement data unless INIT:CONTInuous is ON. If you change any measurement settings after using the CONFigure command, the READ command can be used to initiate a measurement without changing the settings back to their defaults.

In the Swept SA measurement in Spectrum Analyzer mode the CONFigure command also turns the averaging function on and sets the number of averages to 10 for all measurements.

:CONFigure: <measurement>: NDEFault stops the current measurement and changes to the specified measurement. It does not change the settings to the defaults. It does not initiate the taking of measurement data unless INIT:CONTInuous is ON.

The CONFigure? query returns the current measurement name.

The CONFigure:CATalog? query returns a quoted string of all licensed measurement names in the current mode. For example, "SAN, CHP, OBW, ACP, PST, TXP, SPUR, SEM, LIST".

---

#### Fetch Commands:

:FETCh:<measurement>[n]?

This command puts selected data from the most recent measurement into the output buffer. Use FETCh if you have already made a good measurement and you want to return several types of data (different [n] values, for example, both scalars and trace data) from a single measurement. FETCh saves you the time of re-making the measurement. You can only FETCh results from the measurement that is currently active, it will not change to a different measurement. An error message is reported if a measurement other than the current one is specified.

If you need to get new measurement data, use the READ command, which is equivalent to an INITiate followed by a FETCh.

The scalar measurement results will be returned if the optional [n] value is not included, or is set to 1. If the [n] value is set to a value other than 1, the selected trace data results will be returned. See each command for details of what types of scalar results or trace data results are available. The binary data formats should be used for handling large blocks of data since they are smaller and transfer faster than the ASCII format. (FORMat:DATA)

FETCh may be used to return results other than those specified with the original READ or MEASure command that you sent.

---

#### INITiate Commands:

:INITiate:<measurement>

This command is not available for measurements in all the instrument modes:

- Initiates a trigger cycle for the specified measurement, but does not output any data. You must then use the FETCh<meas> command to return data. If a measurement other than the current one is specified, the instrument will switch to that measurement and then initiate it.
- For example, suppose you have previously initiated the ACP measurement, but now you are running the channel power measurement. If you send INIT:ACP? it will change from channel power to ACP and will initiate an ACP measurement.
- Does not change any of the measurement settings. For example, if you have previously started the ACP measurement and you send INIT:ACP? it will initiate a new ACP measurement using the same instrument settings as the last time ACP was run.
- If your selected measurement is currently active (in the idle state) it triggers the measurement, assuming the trigger conditions are met. Then it completes one trigger cycle. Depending upon the measurement and the number of averages, there may be multiple data acquisitions, with multiple trigger events, for one full trigger cycle. It also holds off additional commands on GPIB until the acquisition is complete.

---

#### READ Commands:

:READ:<measurement>[n]?

- Does not preset the measurement to the factory default settings. For example, if you have previously initiated the ACP
-

---

measurement and you send READ:ACP? it will initiate a new measurement using the same instrument settings.

- Initiates the measurement and puts valid data into the output buffer. If a measurement other than the current one is specified, the instrument will switch to that measurement before it initiates the measurement and returns results.
  - For example, suppose you have previously initiated the ACP measurement, but now you are running the channel power measurement. Then you send READ:ACP? It will change from channel power back to ACP and, using the previous ACP settings, will initiate the measurement and return results.
  - Blocks other SCPI communication, waiting until the measurement is complete before returning the results
  - If the optional [n] value is not included, or is set to 1, the scalar measurement results will be returned. If the [n] value is set to a value other than 1, the selected trace data results will be returned. See each command for details of what types of scalar results or trace data results are available. The binary data formats should be used when handling large blocks of data since they are smaller and faster than the ASCII format. (FORMat:DATA)
- 

---

Initial S/W Revision	Prior to A.02.00
----------------------	------------------

---

### Current Measurement Query (Remote Command Only)

This command returns the name of the measurement that is currently running.

---

<b>Remote Command</b>	:CONFigure?
-----------------------	-------------

<b>Example</b>	CONF?
----------------	-------

Initial S/W Revision	Prior to A.02.00
----------------------	------------------

---

### Limit Test Current Results (Remote Command Only)

Queries the status of the current measurement limit testing. It returns a 0 if the measured results pass when compared with the current limits. It returns a 1 if the measured results fail any limit tests.

---

<b>Remote Command</b>	:CALCulate:CLIMits:FAIL?
-----------------------	--------------------------

<b>Example</b>	CALC:CLIM:FAIL? queries the current measurement to see if it fails the defined limits. Returns a 0 or 1: 0 it passes, 1 it fails.
----------------	--

Initial S/W Revision	Prior to A.02.00
----------------------	------------------

---

### Data Query (Remote Command Only)

Returns the designated measurement data for the currently selected measurement and subopcode.

n = any valid subopcode for the current measurement. See the measurement command results table for your current measurement, for information about what data is returned for the subopcodes.

This command uses the data setting specified by the FORMat:BORDER and FORMat:DATA commands and can return real or ASCII data. (See the format command descriptions under Input/Output in the Analyzer Setup section.)

<b>Remote Command</b>	:CALCulate:DATA[n]?
<b>Notes</b>	The return trace depends on the measurement. In CALCulate:<meas>:DATA[n], n is any valid subopcode for the current measurement. It returns the same data as the FETCH:<measurement>? query where <measurement> is the current measurement.
<b>Initial S/W Revision</b>	Prior to A.02.00

### Calculate/Compress Trace Data Query (Remote Command Only)

Returns compressed data for the currently selected measurement and sub-opcode [n].

n = any valid sub-opcode for that measurement. See the MEASure:<measurement>? command description of your specific measurement for information on the data that can be returned.

The data is returned in the current Y Axis Unit of the analyzer. The command is used with a sub-opcode <n> (default=1) to specify the trace. With trace queries, it is best if the analyzer is not sweeping during the query. Therefore, it is generally advisable to be in Single Sweep, or Update=Off.

This command is used to compress or decimate a long trace to extract and return only the desired data. A typical example would be to acquire N frames of GSM data and return the mean power of the first burst in each frame. The command can also be used to identify the best curve fit for the data.

<b>Remote Command</b>	:CALCulate:DATA<n>:COMPRESS? BLOCK   CFIT   MAXimum   MINimum   MEAN   DMEan   RMS   RMSCubed   SAMPLE   SDEVIation   PPHase [,<soffset> [,<length>[,<roffset>[,<rlimit>]]]]
<b>Example</b>	To query the mean power of a set of GSM bursts: Supply a signal that is a set of GSM bursts. Select the IQ Waveform measurement (in IQ Analyzer Mode). Set the sweep time to acquire at least one burst. Set the triggers such that acquisition happens at a known position relative to a burst. Then query the mean burst levels using, CALC:DATA2:COMP? MEAN, 24e-6, 526e-6 (These parameter values correspond to GSM signals, where 526e-6 is the length of the burst in the slot and you just want 1 burst.)
<b>Notes</b>	The command supports 5 parameters. Note that the last 4 (<soffset>, <length>, <roffset>, <rlimit>) are optional. But these optional parameters must be entered in the specified order. For example, if you want to specify <length>, then you must also specify <soffset>. See details below for a definition of each of these parameters.  This command uses the data in the format specified by FORMat:DATA, returning either binary or ASCII data.
<b>Initial S/W Revision</b>	Prior to A.02.00

- BLOCK or block data - returns all the data points from the region of the trace data that you specify. For example, it could be used to return the data points of an input signal over several timeslots, excluding the portions of the trace data that you do not want. (This is x,y pairs for trace data and I,Q pairs for complex data.)

- CFIT or curve fit - applies curve fitting routines to the data. <soffset> and <length> are required to define the data that you want. <roffset> is an optional parameter for the desired order of the curve equation. The query will return the following values: the x-offset (in seconds) and the curve coefficients ((order + 1) values).

MIN, MAX, MEAN, DME, RMS, RMSC, SAMP, SDEV and PPH return one data value for each specified region (or <length>) of trace data, for as many regions as possible until you run out of trace data (using <roffset> to specify regions). Or they return the number of regions you specify (using <rlimit>) ignoring any data beyond that.

- MINimum - returns the minimum data point (y value) for the specified region(s) of trace data. For I/Q trace data, the minimum magnitude of the I/Q pairs is returned.
- MAXimum - returns the maximum data point (y value) for the specified region(s) of trace data. For I/Q trace data, the maximum magnitude of the I/Q pairs is returned.
- MEAN - returns a single value that is the arithmetic mean of the data point values (in dB/ dBm) for the specified region(s) of trace data. For I/Q trace data, the mean of the magnitudes of the I/Q pairs is returned. See the following equations.

•

---

**NOTE** If the original trace data is in dB, this function returns the arithmetic mean of those log values, not log of the mean power which is a more useful value. The mean of the log is the better measurement technique when measuring CW signals in the presence of noise. The mean of the power, expressed in dB, is useful in power measurements such as Channel Power. To achieve the mean of the power, use the RMS option.

---

Equation 1

Mean Value of Data Points for Specified Region(s)

$$MEAN = \frac{1}{n} \sum_{X_i \in \text{region}(s)} X_i$$

where  $X_i$  is a data point value, and  $n$  is the number of data points in the specified region(s).

Equation 2

Mean Value of I/Q Data Pairs for Specified Region(s)

$$MEAN = \frac{1}{n} \sum_{X_i \in \text{region}(s)} |X_i|$$

where  $|X_i|$  is the magnitude of an I/Q pair, and  $n$  is the number of I/Q pairs in the specified region(s).

- DMEan - returns a single value that is the mean power (in dB/ dBm) of the data point values for the specified region(s) of trace data. See the following equation:

Equation 3

DMEan Value of Data Points for Specified Region(s)

$$\text{DME} = 10 \times \log_{10} \left( \frac{1}{n} \sum_{X_i \in \text{region}(s)} 10^{\frac{X_i}{10}} \right)$$

- RMS - returns a single value that is the average power on a root-mean-squared voltage scale (arithmetic rms) of the data point values for the specified region(s) of trace data. See the following equation.

**NOTE**

For I/Q trace data, the rms of the magnitudes of the I/Q pairs is returned. See the following equation. This function is very useful for I/Q trace data. However, if the original trace data is in dB, this function returns the rms of the log values which is not usually needed.

Equation 4

RMS Value of Data Points for Specified Region(s)

$$\text{RMS} = \sqrt{\frac{1}{n} \sum_{X_i \in \text{region}(s)} X_i^2}$$

where  $X_i$  is a data point value, and  $n$  is the number of data points in the specified region(s).

Equation 5

RMS Value of I/Q Data Pairs for Specified Region(s)

$$\text{RMS} = \sqrt{\frac{1}{n} \sum_{X_i \in \text{region}(s)} X_i X_i^*}$$

where  $X_i$  is the complex value representation of an I/Q pair,  $X_i^*$  its conjugate complex number, and  $n$  is the number of I/Q pairs in the specified region(s).

Once you have the rms value for a region of trace data (linear or I/Q), you may want to calculate the mean power. You must convert this rms value (peak volts) to power in dBm:

$$10 \times \log[10 \times (\text{rms value})^2]$$

- SAMPLe - returns the first data value (x,y pair) for the specified region(s) of trace data. For I/Q trace data, the first I/Q pair is returned.
- SDEViation - returns a single value that is the arithmetic standard deviation for the data point values for the specified region(s) of trace data. See the following equation.
- For I/Q trace data, the standard deviation of the magnitudes of the I/Q pairs is returned. See the following equation.

Equation 6

Standard Deviation of Data Point Values for Specified Region(s)

$$\text{SDEV} = \sqrt{\frac{1}{n} \sum_{X_i \in \text{region}(s)} (X_i - \bar{X})^2}$$

where  $X_i$  is a data point value,  $\bar{X}$  is the arithmetic mean of the data point values for the specified region (s), and  $n$  is the number of data points in the specified region(s).

$$\text{SDEV} = \sqrt{\frac{1}{n} \sum_{X_i \in \text{region}(s)} (|X_i| - \bar{X})^2}$$

where  $|X_i|$  is the magnitude of an I/Q pair,  $\bar{X}$  is the mean of the magnitudes for the specified region(s), and  $n$  is the number of data points in the specified region(s).

- PPHase - returns the x,y pairs of both rms power (dBm) and arithmetic mean phase (radian) for every specified region and frequency offset (Hz). The number of pairs is defined by the specified number of regions. This parameter can be used for I/Q vector ( $n=0$ ) in Waveform (time domain) measurement and all parameters are specified by data point in PPHase.

The rms power of the specified region may be expressed as:

$$\text{Power} = 10 \times \log [10 \times (\text{RMS I/Q value})] + 10.$$

The RMS I/Q value (peak volts) is:

$$\sqrt{\frac{1}{n} \sum_{X_i \in \text{region}} X_i X_i^*}$$

where  $X_i$  is the complex value representation of an I/Q pair,  $X_i^*$  its conjugate complex number, and  $n$  is the number of I/Q pairs in the specified region.

The arithmetic mean phase of the specified region may be expressed as:

$$\frac{1}{n} \sum_{Y_i \in \text{region}} Y_i$$

where  $Y_i$  is the unwrapped phase of I/Q pair with applying frequency correction and  $n$  is the number of I/Q pairs in the specified region.

The frequency correction is made by the frequency offset calculated by the arithmetic mean of every specified region's frequency offset. Each frequency offset is calculated by the least square method against the unwrapped phase of I/Q pair.

Sample Trace Data - Constant Envelope

(See below for explanation of variables.)

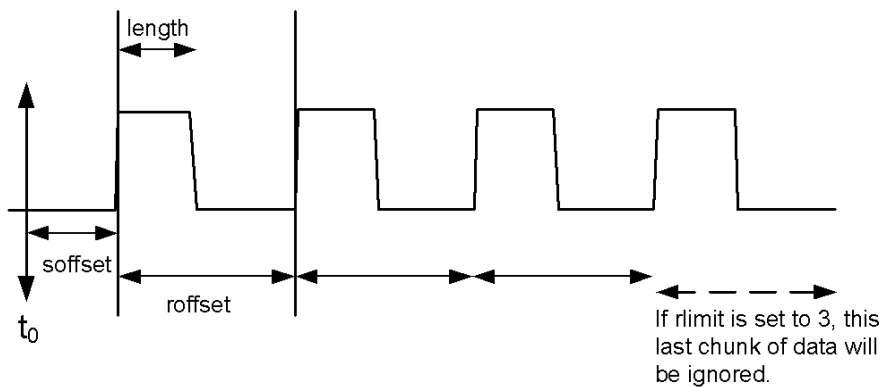

### Sample Trace Data - Not Constant Envelope

(See below for explanation of variables.)

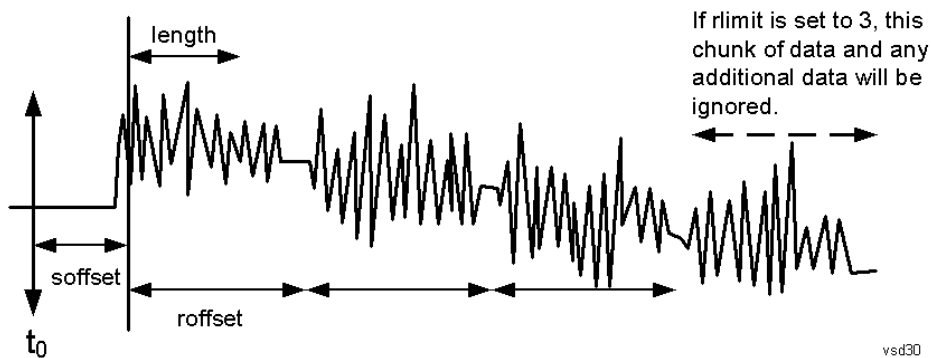

<soffset> - start offset is an optional real number. (It is in seconds for time-domain traces, and is a dimensionless index 0 to Npoints - 1, for frequency-domain traces). It specifies the amount of data at the beginning of the trace that will be ignored before the decimation process starts. It is the time or frequency change from the start of the trace to the point where you want to start using the data. The default value is zero.

<length> - is an optional real number. (It is in seconds for time-domain traces, and is a dimensionless index 0 to Npoints - 1, for frequency-domain traces). It defines how much data will be compressed into one value. This parameter has a default value equal to the current trace length.

<roffset> - repeat offset is an optional real number. (It is in seconds for time-domain traces, and is a dimensionless index 0 to Npoints - 1, for frequency-domain traces). It defines the beginning of the next field of trace elements to be compressed. This is relative to the beginning of the previous field. This parameter has a default value equal to the <length> variable. Note that this parameter is used for a completely different purpose when curve fitting (see CFIT above).

<rlimit> - repeat limit is an optional integer. It specifies the number of data items that you want returned. It will ignore any additional items beyond that number. You can use the Start offset and the Repeat limit to pick out exactly what part of the data you want to use. The default value is all the data.

## Calculate Peaks of Trace Data (Remote Command Only)

Returns a list of all the peaks for the currently selected measurement and sub-opcode [n]. The peaks must meet the requirements of the peak threshold and excursion values.

n = any valid sub-opcode for the current measurement. See the MEASure:<measurement> command description of your specific measurement for information on the data that can be returned.

The command can only be used with specific sub-opcodes with measurement results that are trace data. Both real and complex traces can be searched, but complex traces are converted to magnitude in dBm. In many measurements the sub-opcode n=0, is the raw trace data which cannot be searched for peaks. And Sub-opcode n=1, is often calculated results values which also cannot be searched for peaks.

This command uses the data setting specified by the FORMat:BORDER and FORMat:DATA commands and can return real or ASCII data. If the format is set to INT,32, it returns REAL,32 data.

The command has four types of parameters:

- Threshold (in dBm)
- Excursion (in dB)
- Sorting order (amplitude, frequency, time)
- Optional in some measurements: Display line use (all, > display line, < display line)

---

<b>Remote Command</b>	<p>For Swept SA measurement:</p> <pre>:CALCulate:DATA[1] 2 ... 6:PEAKs? &lt;threshold&gt;,&lt;excursion&gt;[,AMPLitude   FREQuency   TIME[,ALL   GTDLLine   LTDLine]]</pre> <p>For most other measurements:</p> <pre>:CALCulate:DATA[1] 2 ... 6:PEAKs? &lt;threshold&gt;,&lt;excursion&gt;[,AMPLitude   FREQuency   TIME]</pre>
-----------------------	---

---

<b>Example</b>	<p>Example for Swept SA measurement in Spectrum Analyzer Mode:</p> <p>CALC:DATA4:PEAK? -40, 10, FREQ, GTDL This will identify the peaks of trace 4 that are above -40 dBm, with excursions of at least 10 dB. The peaks are returned in order of increasing frequency, starting with the lowest frequency. Only the peaks that are above the display line are returned.</p> <p>Query Results 1:</p> <p>With FORMat:DATA REAL, 32 selected, it returns a list of floating-point numbers. The first value in the list is the number of peak points that are in the following list. A peak point consists of two values: a peak amplitude followed by its corresponding frequency (or time).</p> <p>If no peaks are found the peak list will consist of only the number of peaks, (0).</p>
----------------	---

---

<b>Notes</b>	<p>&lt;n&gt; - is the trace that will be used</p> <p>&lt;threshold&gt; - is the level below which trace data peaks are ignored. Note that the threshold value is required and is always used as a peak criterion. To effectively disable the threshold criterion for this command, provide a substantially low threshold value such as -200 dBm. Also note that the threshold value used in this command is independent of and has no effect on the threshold value stored under the Peak Criteria menu.</p> <p>&lt;excursion&gt; - is the minimum amplitude variation (rise and fall) required for a signal to be identified as peak. Note that the excursion value is required and is always used as a peak criterion. To effectively disable the excursion criterion for this command, provide the minimum value of 0.0 dB. Also note that the excursion value used in this command is independent of and has no effect on the</p>
--------------	---

---



---

excursion value stored under the Peak Criteria menu.

Values must be provided for threshold and excursion. The sorting and display line parameters are optional (defaults are AMPLitude and ALL).

Note that there is always a Y-axis value for the display line, regardless of whether the display line state is on or off. It is the current Y-axis value of the display line which is used by this command to determine whether a peak should be reported

Sorting order:

AMPLitude - lists the peaks in order of descending amplitude, with the highest peak first (default if optional parameter not sent)

FREQUency - lists the peaks in order of occurrence, left to right across the x-axis.

TIME - lists the peaks in order of occurrence, left to right across the x-axis.

Peaks vs. Display Line:

ALL - lists all of the peaks found (default if optional parameter not sent).

GTDLine (greater than display line) - lists all of the peaks found above the display line.

LTDLine (less than display line) - lists all of the peaks found below the display line.

---

Initial S/W Revision      Prior to A.02.00

---

## Format Data: Numeric Data (Remote Command Only)

This command specifies the format of the trace data input and output. It specifies the formats used for trace data during data transfer across any remote port. It affects only the data format for setting and querying trace data for the :TRACe[:DATA], TRACe[:DATA]?, :CALCulate:DATA[n]? and FETCh:SANalyzer [n]? commands and queries.

---

<b>Remote Command</b>	:FORMat[:TRACe] [:DATA] ASCii INTeger, 32 REAL, 32  REAL, 64 :FORMat[:TRACe] [:DATA] ?
-----------------------	---

---

Notes	<p>The query response is:</p> <p>ASCii: ASC,8</p> <p>REAL,32: REAL,32</p> <p>REAL,64: REAL,64</p> <p>INTeger,32: INT,32</p> <p>When the numeric data format is REAL or ASCii, data is output in the current Y Axis unit. When the data format is INTeger, data is output in units of m dBm (.001 dBm).</p> <p>The INT,32 format returns binary 32-bit integer values in internal units (m dBm), in a definite length block.</p>
-------	---

---

Dependencies	<p>Sending a data format spec with an invalid number (for example, INT,48) generates no error. The analyzer simply uses the default (8 for ASCii, 32 for INTeger, 32 for REAL).</p> <p>Sending data to the analyzer which does not conform to the current FORMat specified, results in an error. Sending ASCII data when a definite block is expected generates message -161 "Invalid Block Data" and sending a definite block when ASCII data is expected generates message -121 "Invalid Character in Number".</p>
--------------	--

---

Preset	ASCii
--------	-------

---

Backwards Compatibility Notes	Note that the INT,32 format is only applicable to the command, TRACe:DATA. This preserves backwards compatibility for the Swept SA measurement. For all other commands/queries which honor FORMat:DATA, if INT,32 is sent the analyzer will behave as though it were set to REAL,32.
-------------------------------	--

---

Initial S/W Revision	Prior to A.02.00
----------------------	------------------

---

The specs for each output type follow:

AScii - Amplitude values are in ASCII, in the current Y Axis Unit, one ASCII character per digit, values separated by commas, each value in the form:

SX.YYYYYEsZZ

Where:

S = sign (+ or -)

X = one digit to left of decimal point

Y = 5 digits to right of decimal point

E = E, exponent header

s = sign of exponent (+ or -)

ZZ = two digit exponent

REAL,32 - Binary 32-bit real values in the current Y Axis Unit, in a definite length block.

REAL,64 - Binary 64-bit real values in the current Y Axis Unit, in a definite length block.

### Format Data: Byte Order (Remote Command Only)

This command selects the binary data byte order for data transfer and other queries. It controls whether binary data is transferred in normal or swapped mode. This command affects only the byte order for setting and querying trace data for the :TRACe[:DATA], TRACe[:DATA]? , :CALCulate:DATA[n]? and FETCh:SANalyzer[n]? commands and queries.

By definition any command that says it uses FORMat:DATA uses any format supported by FORMat:DATA.

The NORMal order is a byte sequence that begins with the most significant byte (MSB) first, and ends with the least significant byte (LSB) last in the sequence: 1|2|3|4. SWAPped order is when the byte sequence begins with the LSB first, and ends with the MSB last in the sequence: 4|3|2|1.

---

<b>Remote Command</b>	:FORMat:BORDER NORMal   SWAPped :FORMat:BORDER?
<b>Preset</b>	NORMal
<b>Initial S/W Revision</b>	Prior to A.02.00

---

## Meas Setup

Displays the menu keys that enable you to setup the measurement.

Key Path	Front-panel key
Notes	Front panel only.
Initial S/W Revision	A.14.00

### Select Disturbance

Specifies the selected disturbance.

Key Path	Meas Setup, Disturbance List
Notes	Front panel only. When select disturbance is the active function, press UP to go up in the disturbance list, and press DOWN to go down in the list.
Dependencies	Yes
Couplings	When the disturbance list is cleared, this value will reset to 0.
Preset	If the disturbance list is empty, =0 If the disturbance list is not empty, = 1
State Saved	Saved in instrument state
Min	0
Max	Number of disturbances in disturbance list
Initial S/W Revision	A.14.00

### Disturbance List

This menu enables you to access the disturbance list related functions.

Key Path	Meas Setup
Initial S/W Revision	A.14.00

### Select Disturbance

Specifies the selected disturbance.

Key Path	Meas Setup, Disturbance List
Notes	Front panel only. When select disturbance is the active function, press UP to go up in the disturbance list, and press DOWN to go down in the list.
Dependencies	Yes
Couplings	When the disturbance list is cleared, this value will reset to 0.

Preset	If the disturbance list is empty, =0 If the disturbance list is not empty, = 1
State Saved	Saved in instrument state
Min	0
Max	Number of disturbances in disturbance list
Initial S/W Revision	A.14.00

## Navigate

This menu enables you to navigate through the disturbance list without using a mouse.

Key Path	Meas Setup, Disturbance List
Initial S/W Revision	A.14.00

## Page Up

Takes you to the next page of disturbance list.

Key Path	Meas Setup, Disturbance List, Navigate
Notes	Front panel only.
Initial S/W Revision	A.14.00

## Page Down

Takes you to the previous page of disturbance list.

Key Path	Meas Setup, Disturbance List, Navigate
Notes	Front panel only.
Initial S/W Revision	A.14.00

## Scroll Left

Scrolls the disturbance list to the left.

Key Path	Meas Setup, Disturbance List, Navigate
Notes	Front panel only.
Initial S/W Revision	A.14.00

## Scroll Right

Scrolls the disturbance list to the right.

Key Path	Meas Setup, Disturbance List, Navigate
Notes	Front panel only.
Initial S/W Revision	A.14.00

## Sort Disturbances

Specifies the disturbance list sorting either based on the duration, detector amplitude, type of disturbance or time in ascending or descending order. During sorting, an advisory message appears on the message bar, "Sorting disturbance list by <sorting type selected>...", for example:  
Sorting signal list by Duration...

Key Path	Meas Setup, Disturbance List, Sort Disturbances
Remote Command	CALCulate:DANalyzer:DLIS:SORT:TYPE DURation   DAMplitude   TDISturbance   TIME  CALCulate:DANalyzer:DLIS:SORT:TYPE?
Example	CALC:DAN:DLIS:SORT:TYPE DUR CALC:DAN:DLIS:SORT:TYPE?
Dependencies	Selecting a sorting mode (pressing the key or sending the equivalent SCPI command) will turn on the Auto Sort state, even if that sorting mode was already selected.
Preset	TIME
State Saved	Saved in instrument state
Range	By Duration   By Detector Amplitude   By Type of Disturbance   By Time
Initial S/W Revision	A.14.00

## By Duration

Specifies the disturbance list will be sorted based on the duration.

Key Path	Meas Setup, Disturbance List, Sort Disturbances
Example	CALC:DAN:DLIS:SORT:TYPE DUR
Initial S/W Revision	A.14.00

## By Detector Amplitude Type

Specifies how the signal list will be sorted based on the detector amplitude type.

Key Path	Meas Setup, Disturbance List, Sort Disturbances, By Detector Amplitude
Remote Command	CALCulate:DANalyzer:DLIS:SORT:DAMplitude PEAK QPEak

	CALCulate:DANalyzer:DLIS:SORT:DAMplitude ?
<b>Example</b>	CALC:DAN:DLIS:SORT:DAMP PEAK CALC:DAN:DLIS:SORT:DAMP?
Dependencies	Selecting the detector amplitude type to be sorted (pressing the key or sending the equivalent SCPI command) will turn on the Auto Sort state, even if that detector amplitude type was already selected.
Preset	PEAK
State Saved	Saved in instrument state
Range	Peak   Quasi Peak
Initial S/W Revision	A.14.00

### By Type of Disturbance

Specifies the disturbance list will be sorted based on type of disturbance.

Key Path	Meas Setup, Disturbance List, Sort Disturbances
<b>Example</b>	CALC:DAN:DLIS:SORT:TYPE TDIS
Initial S/W Revision	A.14.00

### By Time

Specifies the disturbance list will be sorted based on time.

Key Path	Meas Setup, Disturbance List, Sort Disturbances
<b>Example</b>	CALC:DAN:DLIS:SORT:TYPE TIME
Initial S/W Revision	A.14.00

### Sort Order

Chooses the sorting order.

Key Path	Meas Setup, Disturbance List, Sort Disturbances
<b>Remote Command</b>	CALCulate:DANalyzer:DLIS:SORT:ORDER ASCending  DESCending CALCulate:DANalyzer:DLIS:SORT:ORDER?
<b>Example</b>	CALC:DAN:DLIS:SORT:ORD DESC CALC:DAN:DLIS:SORT:ORD?
Dependencies	Selecting the sort order (pressing the key or sending the equivalent SCPI command) will turn on the Auto Sort state, even if that sort order was already selected.
Preset	ASCending
State Saved	Saved in instrument state
Initial S/W Revision	A.14.00

## Auto Sort

If this is turned On, the disturbance list is sorted based on the sorting order and sorting type as selected. If this is Off, the disturbance will be added into the last row of the disturbance list.

<b>Key Path</b>	Meas Setup, Disturbance List, Sort Disturbances
<b>Remote Command</b>	CALCulate:DANalyzer:DLISort:AUTO ON OFF 1 0 CALCulate:DANalyzer:DLISort:AUTO?
<b>Example</b>	CALC:DAN:DLISort:AUTO 1 Turn on auto sorting CALC:DAN:DLISort:AUTO?
<b>Preset</b>	ON
<b>State Saved</b>	Saved in instrument state
<b>Range</b>	On Off
<b>Initial S/W Revision</b>	A.14.00

## Delete All

Deletes all disturbances in the disturbance list. If you accessed this function from the front panel, the following message will prompt you for confirmation to delete the selected disturbances from the disturbance list..

This will delete all disturbances. Are you sure you want to do this? Please press Enter or OK to proceed. Press ESC or Cancel to close this dialog.

<b>Key Path</b>	Meas Setup, Disturbance List
<b>Remote Command</b>	CALCulate:DANalyzer:DLISort:DELETE:ALL
<b>Example</b>	CALC:DAN:DLISort:DEL:ALL
<b>Initial S/W Revision</b>	A.14.00

## Comment

Sets an ASCII comment field for each disturbance in list, which will be shown in the "Comment" column of the disturbance list. This value will be stored in the disturbance list exported file.

<b>Key Path</b>	Meas Setup, Disturbance List
<b>Remote Command</b>	CALCulate:DANalyzer:DLISort:COMMENT <integer>,'string' CALCulate:DANalyzer:DLISort:COMMENT? <integer>
<b>Example</b>	CALC:DAN:DLISort:COMM 1,'Is OK'
<b>Preset</b>	""
<b>State Saved</b>	Saved in instrument state
<b>Initial S/W Revision</b>	A.14.00

## Zoom

Zoom will show trace data to the entire graticule display by magnifying 10% of the current trace data on the selected disturbance.

<b>Key Path</b>	Meas Setup, Disturbance List
<b>Remote Command</b>	:CALCulate:DANalyzer:DLIS:ZOOM <integer>
<b>Example</b>	CALC:DAN:DLIS:ZOOM 3
<b>Notes</b>	If the display range is out of the defined Min or Max of x-axis value of traces, the zoom function will be limited to Min or Max of x-axis value of traces.
<b>Dependencies</b>	This key is grayed out if the new traces range is out of limit of the Min value of x-scale/div after magnifying the traces. If the grayed out key is pressed, an advisory message is generated. If the equivalent SCPI command is sent, this same message is generated as part of a “-200, Execution error” warning.
<b>Couplings</b>	The Ref Value and Scale/Div will be changed to accommodate the new span when disturbance zoom executes.
<b>Initial S/W Revision</b>	A.14.00

## Zoom Out

Restores back to the previous disturbance zoom range completely.

<b>Key Path</b>	Meas Setup, Disturbance List
<b>Remote Command</b>	:CALCulate:DANalyzer:DLIS:ZOOM:OUT
<b>Example</b>	CALC:DAN:DLIS:ZOOM:OUT
<b>Initial S/W Revision</b>	A.14.00

## Setup Table

Setup Table is used to enter the measurement settings.

<b>Key Path</b>	Meas Setup
<b>Initial S/W Revision</b>	A.12.00

## Frequency

Sets the frequency of the measurement. This is for the current measurement and not the global measurement frequency of all the other measurements



Key Path	Meas Setup, Setup Table
<b>Remote Command</b>	[ :SENSe ] :DANalyzer:FREQuency F150KHZ   F500KHZ   F1400KHZ   F30MHZ   MANual  [ :SENSe ] :DANalyzer:FREQuency?
<b>Example</b>	DAN:FREQ F150KHZ DAN:FREQ?
Preset	150 kHz
State Saved	Saved in instrument state
Range	F150kHz F500kHz F1400kHz F30MHZ MANual
Initial S/W Revision	A.14.00

### 150 kHz

Sets the Frequency to 150 kHz.

Key Path	Meas Setup, Setup Table, Frequency
<b>Example</b>	DAN:FREQ F150KHZ
Readback Text	150 kHz
Initial S/W Revision	A.14.00

### 500 kHz

Sets the Frequency to 500 kHz.

Key Path	Meas Setup, Setup Table, Frequency
<b>Example</b>	DAN:FREQ F500kHz
Readback Text	500 kHz
Initial S/W Revision	A.14.00

### 1400 kHz

Sets the Frequency to 1400 kHz.

Key Path	Meas Setup, Setup Table, Frequency
<b>Example</b>	DAN:FREQ F1400 kHz
Readback Text	1400 kHz
Initial S/W Revision	A.14.00

### 30 MHZ

Sets the Frequency to 30 MHz.

Key Path	Meas Setup, Setup Table, Frequency
<b>Example</b>	DAN:FREQ F30MHZ
Readback Text	30 MHZ
Initial S/W Revision	A.14.00

### Manual

Enables you to set the Frequency.

Key Path	Meas Setup, Setup Table, Frequency
<b>Example</b>	DAN:FREQ MAN
Readback Text	<freq>
Initial S/W Revision	A.14.00

Key Path	Meas Setup, Setup Table, Frequency
<b>Remote Command</b>	[ :SENSe ] :DANalyzer:FREQuency:MANual <freq> [ :SENSe ] :DANalyzer:FREQuency:MANual?
<b>Example</b>	DAN:FREQ:MAN 150 KHz DAN:FREQ:MAN?
Preset	150 KHz
State Saved	Saved in instrument state
Min	Depends on the instrument minimum frequency.
Max	Depends on the instrument maximum frequency.
Default Unit	Hz
Initial S/W Revision	A.14.00

### Terminal

Selects the terminal type of the CISPR limit.

Key Path	Meas Setup, Setup Table
<b>Remote Command</b>	CALCulate:DANalyzer:LIMit:CISPr:TERMinal MAINS   LOAD   MP1   MP2   MP3 CALCulate:DANalyzer:LIMit:CISPr:TERMinal?
<b>Example</b>	CALC:DAN:LIM:CISP:TERM MAINS CALC:DAN:LIM:CISP:TERM?

Preset	MAINS
State Saved	Saved in instrument state
Range	Mains   Load   Motor Power 1 <= 700 W   Motor Power 2 700 W < MP <= 1000 W   Motor Power 3 > 1000 W
Initial S/W Revision	A.14.00

## Limit

Enables you to set the desired limit.

Key Path	Meas Setup, Setup Table
<b>Remote Command</b>	CALCulate:DANalyzer:LIMit <amptd> CALCulate:DANalyzer:LIMit? CALCulate:DANalyzer:LIMit:AUTO ON OFF 1 0 CALCulate:DANalyzer:LIMit:AUTO?
<b>Example</b>	CALC:DAN:LIM 50 dBuV CALC:DAN:LIM? CALC:DAN:LIM:AUTO OFF
Preset	66 ON
State Saved	Saved in instrument state
Min	6.99 dBuV
Max	156.99 dBuV
Initial S/W Revision	A.14.00

## Attenuation

Enables you to set the value of the Attenuation parameter. This key only affects the Mechanical Attenuator.

The following amplitude parameters are not settable by the user and therefore do not appear in any menus:

Elec Attenuator	Disabled
Elec Attenuation	0dB
Meas Atten Step	2dB
Max Mixer Level	-10dBm

Key Path	Meas Setup, Setup Table
Remote Command	[ :SENSe]:DANalyzer:POWer[:RF]:ATTenuation <rel_amptd> [ :SENSe]:DANalyzer:POWer[:RF]:ATTenuation? [ :SENSe]:DANalyzer:POWer[:RF]:ATTenuation:AUTO OFF ON 0 1 [ :SENSe]:DANalyzer:POWer[:RF]:ATTenuation:AUTO?
Example	DAN:POW:ATT 10 DAN:POW:ATT?
Dependencies	When external mixing is active, Attenuation is grayed-out.
Couplings	Attenuation auto value is determined from the formula; Attenuation = Limit + 44dB ( Lq ) + 28dB ( Headroom for peak) + 10dB ( default attenuation value) is to avoid excessive compression.
Preset	42 dB ON
State Saved	Saved in instrument state.
Min	0 dB
Max	50 dB (CXA) 60 dB (EXA) 70 dB (MXA, PXA & N9038A)
Default Unit	dB
Initial S/W Revision	A.14.00

## Click Rate

Specifies the Click Rate for the Lq value.

Key Path	Meas Setup, Setup Table
Remote Command	[ :SENSe]:DANalyzer:CRATe: <integer> [ :SENSe]:DANalyzer:CRATe?
Example	DAN:CRAT 10 DAN:CRAT?
Preset	0
State Saved	Saved in instrument state.
Min	1
Max	1000
Initial S/W Revision	A.14.00

Key Path	Meas Setup, Setup Table
Remote Command	[ :SENSe]:DANalyzer:CRATe:TYPe MEASured USER

	<code>[ :SENSe ] :DANalyzer:CRATe:TYPe?</code>
<b>Example</b>	DAN:CRAT:TYP MEASured DAN:CRAT:TYP?
Preset	MEASured
State Saved	Saved in instrument state
Range	MEASured  USER
Readback Text	MEASured  USER
Initial S/W Revision	A.14.00

## Display Setup Table

Turns on and off the setup table. Once you turn off the setup table display, it will stay off even when you press the Setup Table key.

Key Path	Meas Setup, Setup Table
<b>Remote Command</b>	<code>:CALCulate:DANalyzer:TABLE:DISPlay OFF ON 0 1</code> <code>:CALCulate:DANalyzer:TABLE:DISPlay?</code>
<b>Example</b>	CALC:DANalyzer:TABLE:DISP OFF Turn off display setup. CALC:DANalyzer:TABLE:DISP?
Preset	ON
State Saved	Saved in instrument state
Range	OFF ON 0 1
Initial S/W Revision	A.14.00

## Duration

Specifies the max duration of the recorded traces data in a graph.

Key Path	Meas Setup, Setup Table
Initial S/W Revision	A.14.00

## Click Correction

Specifies the amplitude of the correction.

Key Path	Meas Setup, Setup Table
<b>Remote Command</b>	<code>[ :SENSe ] :DANalyzer:CLICk:CORRection &lt;rel_amptd&gt;</code> <code>[ :SENSe ] :DANalyzer:CLICk:CORRection?</code>
<b>Example</b>	DAN:CLIC:CORR -10 dB

	DAN:CLIC:CORR?
Preset	0
State Saved	Saved in instrument state
Min	-100 dB
Max	100 dB
Initial S/W Revision	A.14.00

### Click Count

When turned on, specifies the Click Count value for the test to stop when the measured clicks is equal or more than the entered clicks limit number.

Key Path	Meas Setup, Frequency
Remote Command	[ :SENSe ] :DANalyzer:CLICk:COUNT <integer> [ :SENSe ] :DANalyzer:CLICk:COUNT? [ :SENSe ] :DANalyzer:CLICk:COUNT:STATe ON OFF 1 0 [ :SENSe ] :DANalyzer:CLICk:COUNT:STATe?
Example	DAN:CLIC:COUN 10 DAN:CLIC:COUN? DAN:CLIC:COUNt:STAT OFF
Preset	40 OFF
State Saved	Saved in instrument state
Min	1
Max	1000
Initial S/W Revision	A.14.00

### By $\Delta$ Detector Type

Specifies that the elements in the signal list will be sorted based on the detector to limit delta type.

Key Path	Meas Setup, Signal List, Sort Signals, By $\Delta$ Detector
Remote Command	:CALCulate:FSCan:SLIS:SORT:DLDelta DET1 DET2 DET3 :CALCulate:FSCan:SLIS:SORT:DLDelta?
Example	CALC:FSC:SLIS:SORT:DLD DET2 CALC:FSC:SLIS:SORT:DLD?
Dependencies	This key is grayed out when a scan sequence is running. If the grayed out key is pressed, an advisory message is generated. If the equivalent SCPI command is sent, this same message is generated as part of a “-221, Settings conflict” warning.

Couplings	Selecting the $\Delta$ Detector type to be sorted (pressing the key or sending the equivalent SCPI command) will turn on the Auto Sort state, even if that $\Delta$ Detector type was already selected.
Preset	DET1
State Saved	Saved in instrument state.
Range	Detector 1 Detector 2 Detector 3
Initial S/W Revision	A.07.00

### Meas Preset

This key returns the Meas Local variables in the Disturbance Analyzer measurement to their preset values. This is the same as sending the SCPI command CONF:DAN.

Key Path	Meas Setup
Initial S/W Revision	A.14.00

## Mode

See "[Mode](#)" on page 222



## Mode Preset

Returns the active mode to a known state.

Mode Preset does the following for the currently active mode:

- Aborts the currently running measurement.
- Brings up the default menu for the mode, with no active function.
- Sets measurement Global settings to their preset values for the active mode only.
- Activates the default measurement.
- Brings up the default menu for the mode.
- Clears the input and output buffers.
- Sets Status Byte to 0.

Mode Preset does not:

- Cause a mode switch
- Affect mode persistent settings
- Affect system settings

See "[How-To Preset](#)" on page 1074 for more information.

Key Path	Front-panel key
<b>Remote Command</b>	:SYSTem:PRESet
<b>Example</b>	:SYST:PRES
Notes	*RST is preferred over :SYST:PRES for remote operation. *RST does a Mode Preset, as done by the :SYST:PRES command, and it sets the measurement mode to Single measurement rather than Continuous for optimal remote control throughput. Clears all pending OPC bits. The Status Byte is set to 0.
Couplings	A Mode Preset aborts the currently running measurement, activates the default measurement, and gets the mode to a consistent state with all of the default couplings set.
Backwards Compatibility Notes	In the X-Series, the legacy "Factory Preset" has been replaced with Mode Preset, which only presets the currently active mode, not the entire instrument. In the X-Series, the way to preset the entire instrument is by using System, Restore System Defaults All, which behaves essentially the same way as restore System Defaults does on ESA and PSA. There is also no "Preset Type" as there is on the PSA. There is a green Mode Preset front-panel key that does a Mode Preset and a white-with-green-letters User Preset front-panel key that does a User Preset. The old PRESet:TYPE command is ignored (without generating an error), and SYST:PRES without a parameter does a Mode Preset, which should cover most backward code compatibility issues. The settings and correction data under the Input/Output front-panel key (examples: Input Z Corr, Ext Amp Gain, etc.) are no longer part of any Mode, so they will not be preset by a Mode Preset. They are preset using Restore Input/Output Defaults, Restore System Defaults All. Note that because User Preset does a Recall State, and all of these settings are saved in State, they ARE recalled when using

	User Preset.
Initial S/W Revision	Prior to A.02.00

## How-To Preset

The table below shows all possible presets, their corresponding SCPI commands and front-panel access (key paths). Instrument settings depend on the current measurement context. Some settings are local to the current measurement, some are global (common) across all the measurements in the current mode, and some are global to all the available modes. In a similar way, restoring the settings to their preset state can be done within the different contexts.

Auto Couple - is a measurement local key. It sets all Auto/Man parameter couplings in the measurement to Auto. Any Auto/Man selection that is local to other measurements in the mode will not be affected.

Meas Preset - is a measurement local key. Meas Preset resets all the variables local to the current measurement except the persistent ones.

Mode Preset - resets all the current mode's measurement local and measurement global variables except the persistent ones.

Restore Mode Defaults - resets ALL the Mode variables (and all the Meas global and Meas local variables), including the persistent ones.

Type Of Preset	SCPI Command	Front Panel Access
Auto Couple	:COUPle ALL	Auto Couple front-panel key
Meas Preset	:CONFigure:<Measurement>	Meas Setup Menu
Mode Preset	:SYSTem:PRESet	Mode Preset (green key)
Restore Mode Defaults	:INSTrument:DEFault	Mode Setup Menu
Restore All Mode Defaults	:SYSTem:DEFault MODes	System Menu; Restore System Default Menu
*RST	*RST	not possible (Mode Preset with Single)
Restore Input/Output Defaults	:SYSTem:DEFault INPUt	System Menu; Restore System Default Menu
Restore Power On Defaults	:SYSTem:DEFault PON	System Menu; Restore System Default Menu
Restore Alignment Defaults	:SYSTem:DEFault ALIGN	System Menu; Restore System Default Menu
Restore Miscellaneous Defaults	:SYSTem:DEFault MISC	System Menu; Restore System Default Menu
Restore All System Defaults	:SYSTem:DEFault [ALL] :SYSTem:PRESet:PERsistent	System Menu; Restore System Default Menu
User Preset	:SYSTem:PRESet:USER	User Preset Menu
User Preset All Modes	:SYSTem:PRESet:USER:ALL	User Preset Menu

Power On Mode Preset	:SYSTem:PON:TYPE MODE	System Menu
Power On User Preset	:SYSTem:PON:TYPE USER	System Menu
Power On Last State	:SYSTem:PON:TYPE LAST	System Menu

## Mode Setup

See "[Mode Setup](#)" on page 246

## Peak Search

Displays the Peak Search menu and places the selected marker on the trace point with the maximum y-axis value for that marker's trace. If the selected marker was off, then it is turned on as a normal marker and a peak search is performed.

Peak Search functionality only applicable to those traces on the current x-axis display range.

Key Path	Front-panel key
<b>Remote Command</b>	:CALCulate:DANalyzer:MARKer[1] 2 ... 12:MAXimum
<b>Example</b>	CALC:DAN:MARK1:MAX
State Saved	No
Initial S/W Revision	A.14.00

## Next Peak

Moves the selected marker to the next highest local maximum with a value less than the current marker's. If the selected marker was off, then it is turned on as a normal marker and a peak search is performed.

Key Path	Peak Search
<b>Remote Command</b>	:CALCulate:DANalyzer:MARKer[1] 2 ... 12:MAXimum:NEXT
<b>Example</b>	CALC:DAN:MARK:MAX:NEXT
State Saved	No
Initial S/W Revision	A.14.00

## Min Search

Moves the selected marker to the minimum y-axis value on the current trace. If the selected marker was off, then it is turned on as a normal marker and a peak search is performed.

Key Path	Peak Search
<b>Remote Command</b>	:CALCulate:DANalyzer:MARKer[1] 2 ... 12:MINimum
<b>Example</b>	CALC:DAN:MARK:MIN
State Saved	No
Initial S/W Revision	A.14.00

12 Disturbance Analyzer Measurement  
Print

Print

See "Print" on page 271

## Quick Save

The Quick Save front-panel key repeats the most recent save that was performed from the Save menu, with the following exceptions:

- Register saves are not remembered as Saves for the purpose of the Quick Save function
- If the current measurement does not support the last non-register save that was performed, an informational message is generated, “File type not supported for this measurement”

Quick Save repeats the last type of qualified save (that is, a save qualified by the above criteria) in the last save directory by creating a unique filename using the Auto File Naming algorithm described below.

If Quick Save is pressed after startup and before any qualified Save has been performed, the Quick Save function performs a Screen Image save using the current settings for Screen Image saves (current theme, current directory), which then becomes the “last save” for the purpose of subsequent Quick Saves.

The Auto File Naming feature automatically generates a file name for use when saving a file. The filename consists of a prefix and suffix separated by a dot, as is standard for the Windows® file system. A default prefix exists for each of the available file types:

Type	Default Prefix	Menu
State	State_	(Save/Recall)
Trace + State	State_	(Save/Recall)
Screen	Screen_	(Save/Recall)
Amplitude Corrections	Ampcor_	(Import/Export)
Traces	Trace_	(Import/Export)
Limit Lines	LLine_	(Import/Export)
Measurement Result	MeasR_	(Import/Export)
Capture Buffer	CapBuf_	(Import/Export)

A four digit number is appended to the prefix to create a unique file name. The numbering sequence starts at 0000 within each Mode for each file type and updates incrementally to 9999, then wraps to 0000 again. It remembers where it was through a Mode Preset and when leaving and returning to the Mode. It is reset by Restore Misc Defaults and Restore System Defaults and subsequent running of the instrument application. So, for example, the first auto file name generated for State files is State\_0000.state. The next is State\_0001, and so forth.

One of the key features of Auto File Name is that we guarantee that the Auto File Name will never conflict with an existing file. The algorithm looks for the next available number. If it gets to 9999, then it looks for holes. If it find no holes, that is no more numbers are available, it gives an error.

For example, if when we get to State\_0010.state there is already a State\_0010.state file in the current directory, it advances the counter to State\_0011.state to ensure that no conflict will exist (and then it verifies that State\_0011.state also does not exist in the current directory and advances again if it does, and so forth).

If you enter a file name for a given file type, then the prefix becomes the filename you entered instead of the default prefix, followed by an underscore. The last four letters (the suffix) are the 4-digit number.

For example, if you save a measurement results file as “fred.csv”, then the next auto file name chosen for a measurement results save will be fred\_0000.csv.

**NOTE**

Although 0000 is used in the example above, the number that is used is actually the current number in the Meas Results sequence, that is, the number that would have been used if you had not entered your own file name.

---

**NOTE**

If the filename you entered ends with \_dddd, where d=any number, making it look just like an auto file name, then the next auto file name picks up where you left off with the suffix being dddd + 1.

---

Key Path	Front-panel key
Notes	No remote command for this key specifically.
Initial S/W Revision	Prior to A.02.00



## Recall

The recall key accesses the menu that allows you to load a measurement state and data from external files or registers.

Key Path	Front-panel key
Initial S/W Revision	A.07.00

## State

The Recall State menu lets you choose a register or file from which to recall the state.

The content of a state file includes all of the settings and data required to return the analyzer as closely as possible to the Mode it was in, with the exact settings that were in place, when the save occurred. The Mode settings in each state file include the settings that are affected by Mode Preset, as well as the additional settings affected by Restore Mode Defaults; all of the Mode's settings. In addition, all of the settings of the Input/Output system are included, even though they are outside of the Mode's state, because they are needed to restore the complete setup. Persistent System settings (for example, GPIB address) are not affected by either a Mode Preset or Restore Mode Defaults, nor are they included in a saved State file.

Since each state file is only for one Mode, the settings for other Modes are unaffected when it is loaded. Recall State will cause a mode switch if the state being recalled is not from the current active mode.

After the recall completes, the message "File <filename> recalled" or "Recalled State Register <register number>" is displayed.

For rapid recalls, the State menu lists 16 registers that you can choose from to recall. Pressing a Register key initiates the recall. You can also select a file from which to recall.

The default path for all State Files is:

My Documents\<<mode name>\state

where <mode name> is the parameter used to select the mode with the INST:SEL command (for example, SA for the Spectrum Analyzer).

See "[More Information](#)" on page 1082.

Key Path	Recall
Mode	All
<b>Remote Command</b>	:MMEMory:LOAD:STATe <filename>
<b>Example</b>	:MMEM:LOAD:STAT "myState.state" This recalls the file myState.state on the default path
<b>Example</b>	MMEM:LOAD:STAT "MyStateFile.state" This loads the state file data (on the default file directory path) into the instrument state.
Notes	When you pick a file to recall, the analyzer first verifies that the file is recallable in the current instrument by checking the software version and model number of the instrument. If everything

matches, a full recall proceeds by aborting the currently running measurement, clearing any pending operations, and then loading the State from the saved state file. You can open state files from any mode, so recalling a State file switches to the mode that was active when the save occurred. After switching to the mode of the saved state file, mode settings and data (if any for the mode) are loaded with values from the saved file. The saved measurement of the mode becomes the newly active measurement and the data relevant to the measurement (if there is any) is recalled.

If there is a mismatch between file version or model number or instrument version or model number, the recall function tries to recall as much as possible and returns a warning message. It may limit settings that differ based on model number, licensing or version number.

After recalling the state, the Recall State function does the following:

- Makes the saved measurement for the mode the active measurement.
- Clears the input and output buffers.
- Status Byte is set to 0.
- Executes a \*CLS

If the file specified is empty an error is generated. If the specified file does not exist, another error is generated. If there is a mismatch between the file and the proper file type, an error is generated. If there is a mismatch between file version or model number or instrument version or model number, a warning is displayed. Then it returns to the State menu and File Open dialog goes away.

After the Recall, the analyzer exits the Recall menu and returns to the previous menu.

<b>Backwards Compatibility SCPI</b>	:MMEMory:LOAD:STATe 1,<filename>
Initial S/W Revision	Prior to A.02.00

### More Information

In measurements that support saving Traces, for example, Swept SA, the Trace data is saved along with the State in the State file. When recalling the State, the Trace data is recalled as well. Traces are recalled exactly as they were stored, including the writing mode and update and display modes. If a Trace was updating and visible when the State was saved, it will come back updating and visible, and its data will be rewritten right away. When you use State to save and recall traces, any trace whose data must be preserved should be placed in View or Blank mode before saving.

The following table describes the Trace Save and Recall possibilities:

You want to recall state and one trace's data, leaving other traces unaffected.	Save Trace+State from 1 trace. Make sure that no other traces are updating (they should all be in View or Blank mode) when the save is performed.	On Recall, specify the trace you want to load the one trace's data into. This trace will load in View. All other traces' data will be unaffected, although their trace mode will be as it was when the state save was performed.
You want to recall all traces	Save Trace+State from ALL traces.	On Recall, all traces will come back in View (or Blank if they were in Blank or Background when saved)

You want all traces to load exactly as they were when saved.

Save State

On recall, all traces' mode and data will be exactly as they were when saved. Any traces that were updating will have their data immediately overwritten.

### From File...

When you press “From File”, the analyzer brings up a Windows dialog and a menu entitled “File Open.” This menu allows you to navigate to the various fields in the Windows dialog without using a keyboard or mouse. The Tab and Arrow keys can also be used for dialog navigation.

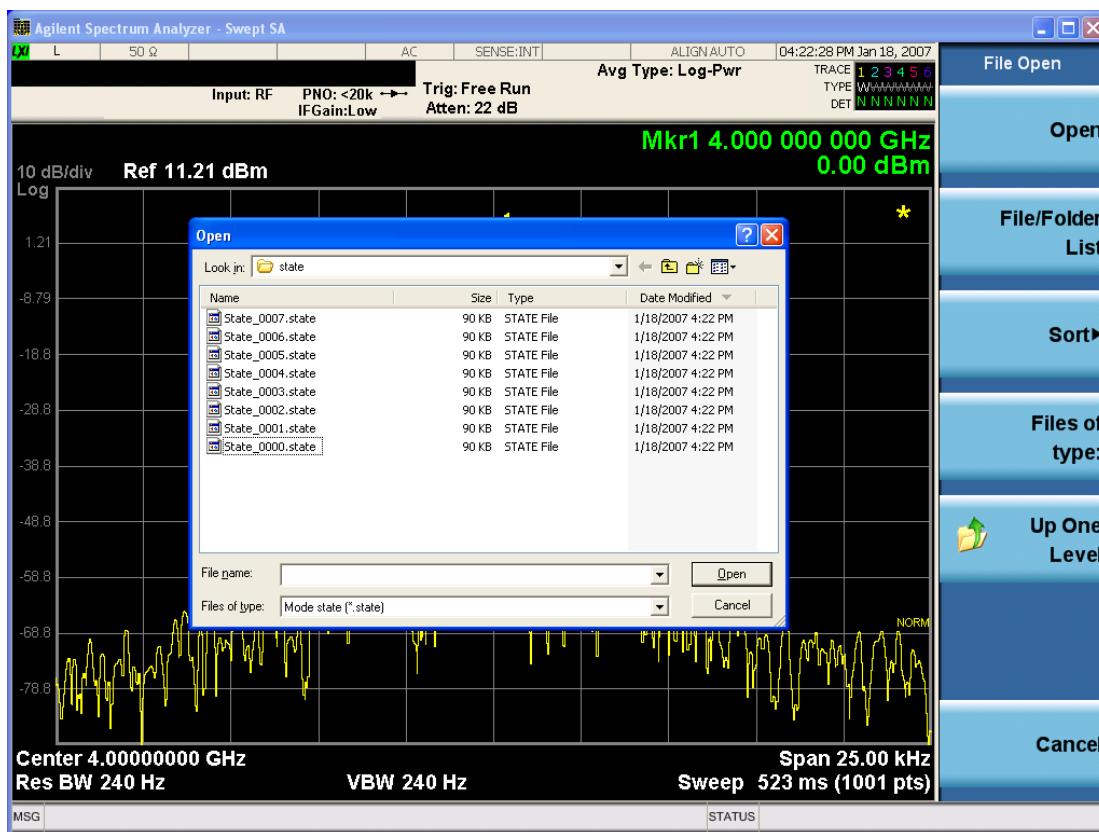

Listed below are the functions of the various fields in the dialog, and the corresponding softkeys:

#### Open

Performs the recall of the specified file. While the recall is being performed, the floppy icon appears briefly in the Meas bar.

#### File/Folder List

Enables you to navigate to the center of the dialog that contains the list of files and folders. Once here you can get information about the file and use the tab keys to navigate to the other fields in the dialog, such as Look In.

### Look In

The Look In field shows the path from which the file will be recalled and allows you to change the path using the up and down arrow keys to navigate to other paths; the Enter key to open a directory; and the Backspace key to go back one directory. The **Look In field** first uses the last path from the Save As dialog **Save In:** path for that same file type. There is no softkey for directly navigating to the Look In field, but you can use the left tab to get here from the File/Folder List.

User specified paths are remembered when you leave and return to a Mode and are reset back to the default using Restore Mode Defaults.

### Sort

Accesses a menu that enables you to sort the files within the File Open dialog. Only one sorting type can be selected at a time and the sorting happens immediately. The sorting types are By Date, By Name, By extension, and By Size.

### Files of Type

This field shows the file suffix for the type of file you have selected to recall. For example, if you navigated here while recalling State, "Mode state (\*.state)" is in the field. If you navigated here while recalling Trace, ""Mode state (\*.trace)" is in the field. If you navigated here while importing a trace data file, "Trace Data (\*.csv)" is in the field. For some file types, there is more than one choice in the dropdown menu, which you can select by using the up and down arrow keys and Enter.

### Up One Level

This key corresponds to the icon of a folder with the up arrow that is in the tool bar of the dialog. When pressed, it causes the file and folder list to navigate up one level in the directory structure. The Backspace key does the same thing.

### Cancel

This key corresponds to the Cancel selection in the dialog. It causes the current **Open** request to be cancelled. The ESC key does the same thing.

Key Path	Recall, State
Notes	Brings up the Open dialog for recalling a State Save Type
Initial S/W Revision	Prior to A.02.00

## Edit Register Names

You may enter a custom name on any of the Register keys, to help you remember what you are using that state to save. To do this, press the Edit Register Names key, choose the register whose name you wish to edit, and then enter the desired label using the Alpha Editor or an external PC keyboard.

The maximum number of characters that can be added is 30. In most cases, 30 characters will fit on two lines of the key.

For more information and the SCPI command, see Edit Register Names under the Save, State function.

Key Path	Recall, State
Mode	All
Dependencies	N9060A-7FP or N9060B-2FP license required to edit the register names. When the feature is not licensed, sending the SCPI command generates an error, -221, "Settings conflict;Option not available"
Initial S/W Revision	A.11.00

### Register 1 thru Register 16

Selecting any one of these register keys causes the State of the mode from the specified Register to be recalled. Each of the register keys annotates whether it is empty or at what date and time it was last modified. In addition, you can use the Edit Register Names key under Save, State to enter custom names for each register.

Registers are shared by all modes, so recalling from any one of the registers will cause a mode switch to the mode that was active when the save to the Register occurred.

Although these 16 registers are the only registers available from the front panel, there are 128 state registers available in the instrument. Registers 17–128 are only available from the SCPI interface, using the \*RCL command.

After the recall completes, the message "Register <register number> recalled" appears in the message bar. If you are in the Spectrum Analyzer Mode, and you are recalling a register that was saved in the Spectrum Analyzer Mode, then after the recall, you will still be in the Recall Register menu. If the Recall causes you to switch modes, then after the Recall, you will be in the Frequency menu.

If a requested register is empty an error is generated.

Key Path	Recall, State
<b>Example</b>	*RCL 1
Range	1-16 from front panel, 1-128 from SCPI
Readback	Date and time with seconds resolution are displayed on the key OR A custom name of up to 30 characters entered using the Save, State,Edit Register Names key OR “(empty)” if no prior save operation has been performed to this register.
Initial S/W Revision	Prior to A.02.00
Modified at S/W Revision	Prior to A.11.00

### Register 1 thru Register 16

Selecting any one of these register keys causes the State of the mode from the specified Register to be recalled. Each of the register keys annotates whether it is empty or at what date and time it was last

modified. In addition, you can use the Edit Register Names key under Save, State to enter custom names for each register.

Registers are shared by all modes, so recalling from any one of the registers will cause a mode switch to the mode that was active when the save to the Register occurred.

Although these 16 registers are the only registers available from the front panel, there are 128 state registers available in the instrument. Registers 17–128 are only available from the SCPI interface, using the \*RCL command.

After the recall completes, the message "Register <register number> recalled" appears in the message bar. If you are in the Spectrum Analyzer Mode, and you are recalling a register that was saved in the Spectrum Analyzer Mode, then after the recall, you will still be in the Recall Register menu. If the Recall causes you to switch modes, then after the Recall, you will be in the Frequency menu.

If a requested register is empty an error is generated.

<b>Key Path</b>	Recall, State
<b>Example</b>	*RCL 1
<b>Range</b>	1–16 from front panel, 1–128 from SCPI
<b>Readback</b>	Date and time with seconds resolution are displayed on the key OR A custom name of up to 30 characters entered using the Save, State, Edit Register Names key OR “(empty)” if no prior save operation has been performed to this register.
<b>Initial S/W Revision</b>	Prior to A.02.00
<b>Modified at S/W Revision</b>	Prior to A.11.00

## Data (Import)

Importing a data file loads data that was previously saved from the current measurement or from other measurements and/or modes that produce compatible data files. The Import Menu only contains Data Types that are supported by the current measurement.

Since the commonly exported data files are in .csv format, the data can be edited by the user prior to importing. This allows you to export a data file, manipulate the data in Excel (the most common PC Application for manipulating .csv files) and then import it.

Importing Data loads measurement data from the specified file into the specified or default destination, depending on the data type selected. Selecting an Import Data menu key will not actually cause the importing to occur, since the analyzer still needs to know from where to get the data. Pressing the Open key in this menu brings up the Open dialog and Open menu that provides you with the options from where to recall the data. Once a filename has been selected or entered in the Open menu, the recall occurs as soon as the Open button is pressed.

<b>Key Path</b>	Recall
<b>Mode</b>	All

Notes	The menu is built from whatever data types are available for the mode. Some keys will be missing completely, so the key locations in the sub-menu will vary. No SCPI command directly controls the Data Type that this key controls. The Data Type is included in the MMEM:LOAD commands.
Dependencies	If a file type is not used by a certain measurement, it is grayed out for that measurement. The key for a file type will not show at all if there are no measurements in the Mode that support it.
Preset	Is not affected by Preset or shutdown, but is reset during Restore Mode Defaults
Readback	The data type that is currently selected
Initial S/W Revision	Prior to A.02.00

## Amplitude Correction

This key selects the Amplitude Corrections as the data type to be imported. When pressed a second time, it brings up the Select Menu, which lets you select the Correction into which the data will be imported.

Amplitude Corrections are fully discussed in the documentation of the Input/Output key, under the Corrections key.

A set of preloaded Corrections files can be found in the directory

/My Documents/ EMC Limits and Ampcor.

When the Amplitude Correction is an Antenna correction and the Antenna Unit in the file is not None, the Y Axis Unit setting will change to match the Antenna Unit in the file.

Key Path	Recall
Mode	SA EDGE GSM PN
Remote Command	:MMEMory:LOAD:CORRection 1 2 3 4 5 6 7 8, <filename>
Example	:MMEM:LOAD:CORR 2, "myAmpcor.csv" recalls the Amplitude Correction data from the file myAmpcor.csv in the current directory to the 2nd Amplitude Correction table, and turns on Correction 2. The default path is D:\User_My_Documents\Instrument\My Documents\amplitudeCorrections\
Dependencies	Only the first correction array (Correction 1) supports antenna units. This means that a correction file with an Antenna Unit can only be loaded into the Corrections 1 register. Consequently only for Correction 1 does the dropdown in the Recall dialog include.ant, and if an attempt is made to load a correction file into any other Correction register which DOES contain an antenna unit, a Mass Storage error is generated. Corrections are not supported by all Measurements. If in a Mode in which some Measurements support it, this key will be grayed out in measurements that do not. The key will not show at all if no measurements in the Mode support it. Errors are reported if the file is empty or missing, or if the file type does not match, or if there is a mismatch between the file type and the destination data type. If any of these occur during manual operation, the analyzer returns to the Import Data menu and the File Open dialog goes away. This key does not appear unless you have the proper option installed in your instrument. This command will generate an "Option not available" error unless you have the proper option installed in your instrument.

Couplings	When a correction file is loaded from mass storage, it is automatically turned on ( <b>Correction ON</b> ) and <b>ApplyCorrections</b> is set to On. This allows you to see its effect, thus confirming the load.
Readback	selected Correction
<b>Backwards Compatibility SCPI</b>	:MMEMory:LOAD:CORRection ANTenna   CABLe   OTHer   USER, <filename> For backwards compatibility, ANTenna maps to 1, CABLe maps to 2, OTHer maps to 3 and USER maps to 4
Initial S/W Revision	A.02.00

## Trace

This key selects Trace as the data type to be imported. When pressed a second time, it brings up the Trace Menu, which lets you select the Trace into which the data will be imported.

The trace file contains “meta” data which describes the state of the analyzer when the trace was exported. If the meta data in the file does not match the current instrument state, the “invalid data indicator” (\*) is displayed.

Key Path	Recall, Data
<b>Remote Command</b>	:MMEMory:LOAD:DTRaces <filename>
<b>Example</b>	:MMEM:LOAD:DTRaces "myPeakTrace.csv" imports traces from the file myPeakTrace.csv in the current path. The default path is My Documents\EMI\data\ DANalyzer\traces
Dependencies	A trace cannot be recalled from a trace file that was exported with ALL traces selected. A trace cannot be imported if the number of trace points in the file do not match the number of trace points currently set for the measurement. If this happens, an error message is generated. Errors are reported if the file is empty or missing, or if the file type does not match, or if there is a mismatch between the file type and the destination data type. If any error occurs while trying to load a file manually (as opposed to during remote operation), the analyzer returns to the Import Data menu and the File Open dialog goes away.
Readback	Selected Trace
Status Bits/OPC dependencies	Sequential - aborts the current measurement.
Initial S/W Revision	A.14.00

## Disturbance List

Selects the disturbance list as the data type to be imported. The next step is to select the Open key in the Import Data menu. Importing a Disturbance List always replaces the data with the data that is already in the disturbance list.

Key Path	Recall, Data
----------	--------------



<b>Remote Command</b>	:MMEMory:LOAD:DLIS <filename>
<b>Example</b>	MMEM:LOAD:DLIS "myDisturbanceList2.csv" Imports the Disturbance List from the file myDisturbanceList2.csv in the default path.
<b>Notes</b>	If the file is empty, error -250.3005 is reported. If the file does not exist error -256 is reported. If there is a mismatch between the file and the destination data type, an error is reported. -250.3003. Then return to the Import Data menu and File Open dialog goes away.
<b>Status Bits/OPC Dependencies</b>	Sequential - aborts the current measurement
<b>Initial S/W Revision</b>	A.14.00

## Open...

When you press "Open", the analyzer brings up a Windows dialog and a menu entitled "File Open." This menu allows you to navigate to the various fields in the Windows dialog without using a keyboard or mouse. The Tab and Arrow keys can also be used for dialog navigation.

See "[From File...](#)" on page 1083 in Recall, State, for a full description of this dialog and menu.

<b>Key Path</b>	Recall, Data
<b>Notes</b>	The key location is mode-dependent and will vary. Brings up Open dialog for recalling a <mode specific> Save Type
<b>Initial S/W Revision</b>	Prior to A.02.00

## State

Most of the functions under this key work the same way in many measurements, so they are documented in the Utility Functions section. For details about this key, see "[State](#)" on page 1081.

## Data (Import)

Most of the functions under this key work the same way in many measurements, so they are documented in the Utility Functions section. For details about this key, see "[Data \(Import\)](#)" on page 1086.

## Amplitude Correction

Most of the functions under this key work the same way in many measurements. For details about this key, see "[Amplitude Correction](#)" on page 1087.

## Default Directory

Specifies the default directory used for loading of Amplitude Correction. If user is selected, the default recall directory is the default (My Documents\amplitudeCorrections) or the last directory you saved the amplitude correction data to. Otherwise, the default recall directory is My Documents\EMC Limits and Ampcor\Ampcor, which contains a set of preloaded amplitude correction files in the directory called Ampcor.

Key Path	Recall, Export Data, Amplitude Correction
Remote Command	:MMEMory:LOAD:CORRection:DDIRectory USER PRELoaded
Example	:MMEM:LOAD:CORR:DDIR USER Select user :MMEM:LOAD:CORR:DDIR?
Notes	USER = User PRELoaded = Preloaded
Preset	PRELoaded
State Saved	Saved in instrument state.
Range	User Preloaded
Readback	"User"  "Preloaded"
Initial S/W Revision	A.13.00

### Trace

This key selects Trace as the data type to be imported. When pressed a second time, it brings up the Trace Menu, which lets you select the Trace into which the data will be imported.

The trace file contains "meta" data which describes the state of the analyzer when the trace was exported (see ). If the meta data in the file does not match the current SA state, the "invalid data indicator" (\*) is displayed.

Key Path	Recall, Data
Remote Command	:MMEMory:LOAD:TRACe:DATA TRACE1 TRACE2 TRACE3,<filename>
Example	:MMEM:LOAD:TRAC DATA TRACE2, "myTrace2.csv" imports the 2nd trace from the file myTrace2.csv in the current path. The default path is My Documents\EMI\data\xxx\traces where xxx is the measurement name.
Dependencies	A trace cannot be recalled from a trace file that was exported with ALL traces selected. A trace cannot be imported if the number of trace points in the file do not match the number of sweep points currently set for the measurement. If this happens, an error message is generated. Errors are reported if the file is empty or missing, or if the file type does not match, or if there is a mismatch between the file type and the destination data type. If any error occurs while trying to load a file manually (as opposed to during remote operation), the analyzer returns to the Import Data menu and the File Open dialog goes away.
Couplings	When a trace is imported, <b>Trace Update</b> is always turned OFF for that trace and <b>Trace Display</b> is always turned ON.
Readback	1 2 3
Status Bits/OPC dependencies	Sequential - aborts the current measurement.
Initial S/W Revision	Prior to A.02.00

## Limit

This key selects Limit Lines as the data type to be imported. When pressed a second time, it brings up the Limits Menu, which lets you select into which Limit the data will be imported.

Key Path	Recall, Data
Remote Command	:MMEMory:LOAD:LIMit LLINE1   LLINE2   LLINE3   LLINE4   LLINE5   LLINE6, <filename>
Example	:MMEM:LOAD:LIM LLINE2, "myLimitLine2.csv" imports the 2nd Limit Line from the file myLimitLine2.csv in the current path. The default path is depending on the Limit Default Directory selection.
Dependencies	Errors are reported if the file is empty or missing, or if the file type does not match, or if there is a mismatch between the file type and the destination data type. If any of these occur during manual operation, the analyzer returns to the Import Data menu and the File Open dialog goes away. This key will only appear if you have the proper option installed in your instrument.
Couplings	When a limit line is loaded from mass storage, it is automatically turned on. This allows you to see it, thus confirming the load. The Margin settings will match those set when the limit was saved
Readback	1 2 3 4 5 6
Status Bits/OPC dependencies	Sequential - aborts the current measurement
Initial S/W Revision	A.02.00

## Default Directory

Specifies the default directory used for loading of Limit. If user is selected, the default recall directory is the default (My Documents\EMI\data\xxx\Limits where xxx is the measurement name) or the last directory you saved the limit line data to. Otherwise, the default recall directory is My Documents\EMC Limits and Ampcor\Limits, which contains a set of preloaded limit files.

Key Path	Recall, Export Data, Limit
Remote Command	:MMEMory:LOAD:LIMit:DDIRectory USER PRELoaded
Example	:MMEM:LOAD:LIM:DDIR USER Select user :MMEM:LOAD:LIM:DDIR?
Notes	USER = User PRELoaded = Preloaded
Preset	PRELoaded
State Saved	Saved in instrument state.
Range	User  Preloaded
Readback	"User" "Preloaded"
Initial S/W Revision	A.13.00

## Open

Most of the functions under this key work the same way in many measurements. For details about this key, see "[Open...](#)" on page 1089.

## Restart

The Restart function restarts the current sweep, or measurement, or set of averaged/held sweeps or measurements. If you are Paused, pressing Restart does a Resume.

The Restart function is accessed in several ways:

- Pressing the Restart key
- Sending the remote command INIT:IMMEDIATE
- Sending the remote command INIT:RESTART

See "[More Information](#)" on page 1093

Key Path	Front-panel key
Remote Command	:INITiate[:IMMEDIATE] :INITiate:RESTART
Example	:INIT:IMM :INIT:REST
Notes	:INITiate:RESTART and :INITiate:IMMEDIATE perform exactly the same function.
Couplings	Resets average/hold count k. For the first sweep overwrites all active (update=on) traces with new current data. For application modes, it resets other parameters as required by the measurement.
Status Bits/OPC dependencies	This is an Overlapped command. The STATUS:OPERation register bits 0 through 8 are cleared. The STATUS:QUESTIONable register bit 9 (INTEgrity sum) is cleared. The SWEEPING bit is set. The MEASURING bit is set.
Backwards Compatibility Notes	For Spectrum Analysis mode in ESA and PSA, the Restart hardkey and the INITiate:RESTART command restart trace averages (displayed average count reset to 1) for a trace in Clear Write, but did not restart Max Hold and Min Hold. In the X-Series, the Restart hardkey and the INITiate:RESTART command restart not only Trace Average, but MaxHold and MinHold traces as well. For wireless comms modes in ESA and PSA, the Restart hardkey and the INITiate:RESTART command restart every measurement, which includes all traces and numeric results. There is no change to this operation.
Initial S/W Revision	Prior to A.02.00

### More Information

The **Restart** function first aborts the current sweep/measurement as quickly as possible. It then resets the sweep and trigger systems, sets up the measurement and initiates a new data measurement sequence with a new data acquisition (sweep) taken once the trigger condition is met.

If the analyzer is in the process of aligning when **Restart** is executed, the alignment finishes before the restart function is performed.

Even when set for Single operation, multiple sweeps may be taken when Restart is pressed (for example, when averaging/holding is on). Thus when we say that **Restart** "restarts a measurement," we may mean:

- It restarts the current sweep
- It restarts the current measurement
- It restarts the current set of sweeps if any trace is in Trace Average, Max Hold or Min Hold
- It restarts the current set of measurements if Averaging, or Max Hold, or Min Hold is on for the measurement
- depending on the current settings.

With **Average/Hold Number** (in **Meas Setup** menu) set to 1, or Averaging off, or no trace in Trace Average or Hold, a single sweep is equivalent to a single measurement. A single sweep is taken after the trigger condition is met; and the analyzer stops sweeping once that sweep has completed. However, with **Average/Hold Number** >1 and at least one trace set to **Trace Average, Max Hold, or Min Hold (SA Measurement)** or **Averaging on (most other measurements)**, multiple sweeps/data acquisitions are taken for a single measurement. The trigger condition must be met prior to each sweep. The sweep is stopped when the average count  $k$  equals the number  $N$  set for **Average/Hold Number**. A measurement average usually applies to all traces, marker results, and numeric results; but sometimes it only applies to the numeric results.

Once the full set of sweeps has been taken, the analyzer will go to idle state. To take one more sweep without resetting the average count, increment the average count by 1, by pressing the step up key while **Average/Hold Number** is the active function, or sending the remote command CALC:AVER:TCON UP.

## Save

The Save menu lets you choose what you want to save and where you want to save it. Among the types of files you can save are **States**, **Traces**, and **Screen Images**. In addition, an Export (Data) option lets you save a number of data types as CSV files for easy import into Excel and other spreadsheet programs.

Key Path	Front-panel key
Mode	All
Notes	No remote command for this key specifically, but the :MMEM:STORe command is available for specific file types. An example is :MMEM:STOR:STATe <filename>.
Initial S/W Revision	Prior to A.02.00

## State

The Save State menu lets you choose a register or file for saving the state.

The content of a state file includes all of the settings and data required to return the analyzer as closely as possible to the Mode it was in, with the exact settings which were in place, when the save occurred. The Mode settings in each state file include the settings that are affected by Mode Preset, as well as the additional settings affected by Restore Mode Defaults; all of the Mode's settings. In addition, all of the settings of the Input/Output system are included, even though they are outside of the Mode's state, because they are needed to restore the complete setup. Persistent System settings (for example, Verbose SCPI) are not affected by either Mode Preset or Restore Mode Defaults, nor are they included in a saved State file.

After the save completes, the message "File <filename> saved" or "State Register <register number> saved" is displayed.

For rapid saving, the State menu lists 16 registers to save to. Pressing a Register key initiates the save. You can also select a file to save to.

The default path for all State Files is:

My Documents\<>mode name>\state

where <mode name> is the parameter used to select the mode with the INST:SEL command (for example, SA for the Spectrum Analyzer).

Key Path	Save
Mode	All
Remote Command	:MMEMory:STORe:STATe <filename>
Example	MMEM:STOR:STATe "MyStateFile.state" This stores the current instrument state data in the file MyStateFile.state in the default directory.
Notes	Both single and double quotes are supported for any filename parameter over remote. After saving to a register, that register's menu key is updated with the date the time, unless a custom label has been entered for that key. After saving to a register, you remain in the Save State menu, so that you can see the Register key

update. After saving to a file, the analyzer automatically returns to the previous menu and any Save As dialog goes away.

**Backwards Compatibility SCPI** :MMEMory:STORe:STATe 1,<filename>

For backwards compatibility, the above syntax is supported. The "1" is simply ignored. The command is sequential.

Initial S/W Revision Prior to A.02.00

### To File . . .

When you press “To File”, the analyzer brings up a Windows dialog and a menu entitled “Save As.” This menu allows you to navigate to the various fields in the Windows dialog without using a keyboard or mouse. The Tab and Arrow keys can also be used for dialog navigation.

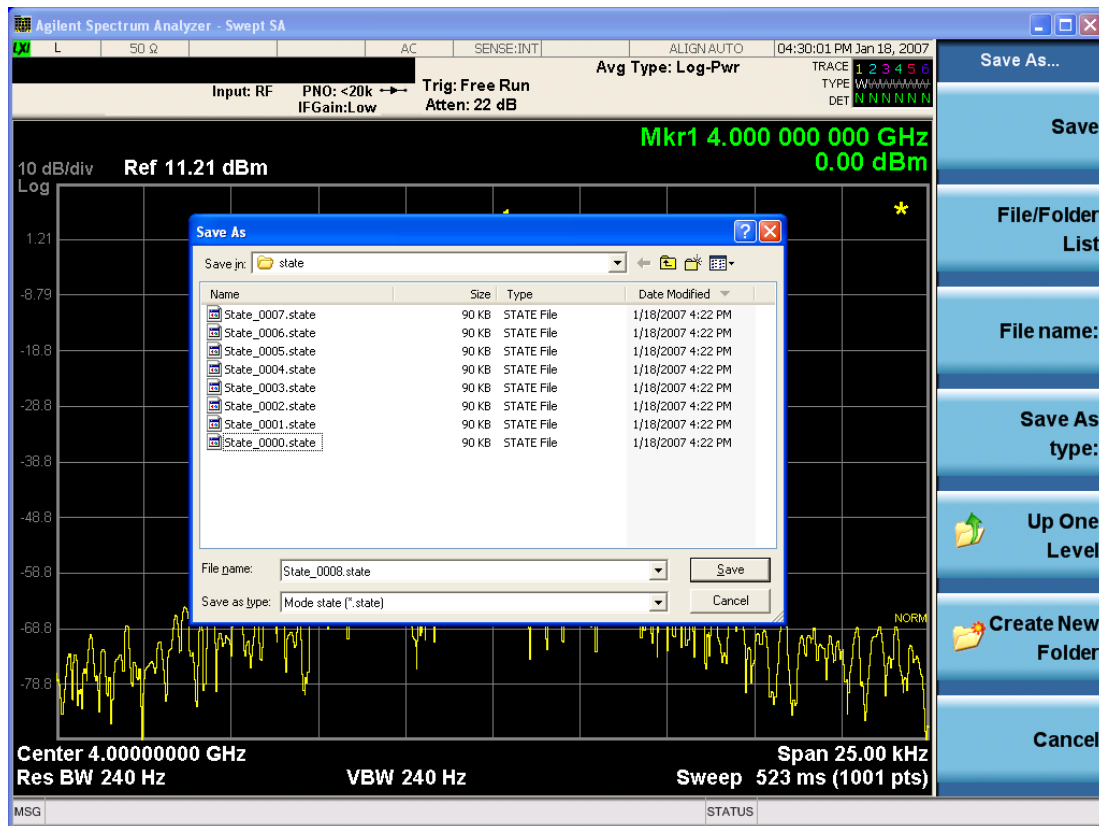

The Listed below

are the functions of the various fields in the dialog, and the corresponding softkeys:

#### Save

Performs the save to the specified file of the selected type. If the file already exists, a dialog will appear that allows you to replace the existing file by selecting OK, or you can Cancel the request. If you select OK, the file will be overwritten. Using the C: drive is strongly discouraged, since it runs the risk of being overwritten during an instrument software upgrade.

While the save is being performed, the floppy icon appears briefly in the Meas bar.



## File/Folder List

Enables you to navigate to the center of the dialog that contains the list of files and folders. Once here you can get information about the file and use the tab keys to navigate to the other fields in the dialog, such as Save In.

## Save In

The Save In field shows the path to which the file will be saved and allows you to change the path using the up and down arrow keys to navigate to other paths; the Enter key to open a directory; and the Backspace key to go back one directory. The **Save In field** defaults to the default path for this type of file and remembers the last path you used to save this type of file. There is no softkey for directly navigating to the Save In field but you can use left tab to get here from the File/Folder List.

User specified paths are remembered when you leave and return to a Mode and are reset back to the default using Restore Mode Defaults.

## File Name

The File Name field is initially loaded with an automatically generated filename specific to the appropriate Save Type. The automatically generated filename is guaranteed not to conflict with any filename currently in the directory. You may replace or modify this filename using the File Name key. See the ["Quick Save " on page 1079](#) documentation for more on the automatic file naming algorithm.

When you press the File Name key the analyzer displays the Alpha Editor. Use the knob to choose the letter to add and the front-panel Enter key to add the letter to the file name. The BK character moves you back and the FW character moves you forward in the filename. The Select key on the front panel generates a space character. When you are done entering the filename press the Done softkey. This returns back to the **File Open** dialog and menu, but does not cause the save to occur.

## Save As Type

This field shows the file suffix for the type of file you have selected to save. For example, if you navigated here while saving State, "Mode state (\*.state)" is in the field. If you navigated here from saving Trace, ""Mode state (\*.trace)" is in the field. If you navigated here while exporting a trace data file, "Trace Data (\*.csv)" is in the field. For some file types, there is more than one choice in the dropdown, which you can select by using the up and down arrow keys and Enter.

## Up One Level

This key corresponds to the icon of a folder with the up arrow that is in the tool bar of the dialog. When pressed, it causes the file and folder list to navigate up one level in the directory structure. The Backspace key does the same thing.

## Create New Folder

This key corresponds to the icon of a folder with the "\*" that is in the tool bar of the dialog. When pressed, a new folder is created in the current directory with the name **New Folder** and you can enter a new folder name using the Alpha Editor.

## Cancel

This key corresponds to the Cancel selection in the dialog. It causes the current **Save As** request to be cancelled. The ESC key does the same thing.

Key Path	Save, State
Mode	All
Notes	Brings up Save As dialog for saving a State Save Type
Initial S/W Revision	Prior to A.02.00

## Edit Register Names

You may enter a custom name on any of the Register keys, to help you remember what you are using that state to save. To do this, press the Edit Register Names key, choose the register whose name you wish to edit, and then enter the desired label using the Alpha Editor or an external PC keyboard.

The maximum number of characters that can be added is 30. In most cases, 30 characters will fit on two lines of the key.

See ["More Information" on page 1098](#)

Key Path	Save, State
Mode	All
<b>Remote Command</b>	:MMEMory:REGister:STATe:LABel <reg number>,"label" :MMEMory:REGister:STATe:LABel? <reg number>
<b>Example</b>	:MMEM:REG:STAT:LAB 1,"my label"
Notes	<reg number> is an integer from 1 to 16. If the SCPI specifies an invalid register number an error message is generated, -222,"Data out of range;Invalid register label number" "label" is a string from 0 to 30 characters in length. If a label exceeds 30 characters, an error message is generated, -150,"String data error;Label clipped to 30 characters" "label" of length 0 erases the custom label and restores the default (time and date) label. E.g.: :MMEM:REG:STAT:LAB 1,""
Dependencies	N9060A-7FP or N9060B-2FP license required to edit the register names. When the feature is not licensed, sending this command generates an error, -221,"Settings conflict;Option not available"
Preset	The names are unaffected by Preset or power cycle but are set to the default label (time and date) on a "Restore System Defaults->Misc"
Initial S/W Revision	A.11.00

## More Information

When you edit one of the register names, the time and date field will be replaced by the custom name.

If you delete all the characters in the custom name, it restores the default (time and date).

The register names are stored within the state files, but they are not part of the instrument state; that is, once you have edited a register name, loading a new state will not change that register name. Another consequence of this is that the names will be persistent through a power cycle. Also, if a named state file is transferred to another analyzer, it will bring its custom name along with it.

If you try to edit the name of an empty register, the analyzer will first save the state to have a file to put the name in. If you load a named state file into an analyzer with older firmware it will ignore the metadata.

The \*SAV and \*RCL commands will not be affected by the custom register names, nor will the MMEM commands.

### Register 1 thru Register 16

Selecting any one of these register menu keys causes the State of the currently active mode to be saved to the specified Register. The registers are provided for rapid saving and recalling, since you do not need to specify a filename or navigate to a file. Each of the register menu keys annotates whether it is empty or at what date and time it was last modified. In addition, you can use the Edit Register Names key to enter custom names for each register.

Although these 16 registers are the only registers available from the front panel, there are 128 state registers available in the instrument. Registers 17–128 are only available from the SCPI interface, using the \*SAV command.

There is one set of 128 state registers in the instrument, not one set for each Mode. When a state is saved, the Mode it was saved from is saved with it; then when it is recalled, the instrument switches to that Mode.

After the save completes, the corresponding register menu key annotation is updated with the date and time and the message "Register <register number> saved" is displayed.

Key Path	Save, State
Mode	All
<b>Example</b>	*SAV 1
Range	1–16 from front panel, 1–128 from SCPI
Readback	Date and time with seconds resolution are displayed on the key OR A custom name of up to 30 characters entered using the Edit Register Names key OR “(empty)” if no prior save operation has been performed to this register.
Initial S/W Revision	Prior to A.02.00
Modified at S/W Revision	A.11.00

### Register 1 thru Register 16

Selecting any one of these register menu keys causes the State of the currently active mode to be saved to the specified Register. The registers are provided for rapid saving and recalling, since you do not need to specify a filename or navigate to a file. Each of the register menu keys annotates whether it is empty or at what date and time it was last modified. In addition, you can use the Edit Register Names key to enter custom names for each register.

Although these 16 registers are the only registers available from the front panel, there are 128 state registers available in the instrument. Registers 17–128 are only available from the SCPI interface, using the \*SAV command.

There is one set of 128 state registers in the instrument, not one set for each Mode. When a state is saved, the Mode it was saved from is saved with it; then when it is recalled, the instrument switches to that Mode.

After the save completes, the corresponding register menu key annotation is updated with the date and time and the message "Register <register number> saved" is displayed.

Key Path	Save, State
Mode	All
Example	*SAV 1
Range	1-16 from front panel, 1-128 from SCPI
Readback	Date and time with seconds resolution are displayed on the key OR A custom name of up to 30 characters entered using the Edit Register Names key OR “(empty)” if no prior save operation has been performed to this register.
Initial S/W Revision	Prior to A.02.00
Modified at S/W Revision	A.11.00

## Data (Export)

Exporting a data file stores data from the current measurement to mass storage files. The Export Menu only contains data types that are supported by the current measurement.

Since the commonly exported data files are in .csv format, the data can be edited by you prior to importing. This allows you to export a data file, manipulate the data in Excel (the most common PC Application for manipulating .csv files) and then import it.

Selecting an Export Data menu key will not actually cause the exporting to occur, since the analyzer still needs to know where you wish to save the data. Pressing the Save As key in this menu brings up the Save As dialog and Save As menu that allows you to specify the destination file and directory. Once a filename has been selected or entered in the Open menu, the export will occur as soon as the Save key is pressed.

Key Path	Save
Mode	All
Notes	The menu is built from whatever data types are available for the mode. So the key locations in the sub menu will vary.  No SCPI command directly controls the Data Type that this key controls. The Data Type is included in the MMEM:STORe commands.
Dependencies	If a file type is not used by a certain measurement, that type is grayed out for that measurement. The key for a file type will not show at all if there are no measurements in the Mode that support it.
Preset	Is not affected by a Preset or shutdown, but is reset during Restore Mode Defaults
Readback	The data type that is currently selected
Initial S/W Revision	Prior to A.02.00

## Amplitude Correction

Pressing this key selects **Amplitude Corrections** as the data type to be exported. Pressing this key again brings up the Select Menu, which allows the user to select which **Amplitude Correction** to save.

Amplitude Corrections are fully discussed in the documentation of the Input/Output key, under the Corrections softkey.

See "[Correction Data File](#)" on page 1101

Key Path	Save
<b>Remote Command</b>	:MMEMory:STORe:CORRection 1 2 3 4 5 6, <filename>
<b>Example</b>	:MMEM:STOR:CORR 2 "myAmpcor.csv" saves Correction 2 to the file myAmpcor.csv on the current path. The default path is My Documents\amplitudeCorrections.
Notes	If the save is initiated via SCPI, and the file already exists, the file will be overwritten. Using the C: drive is strongly discouraged, since it runs the risk of being overwritten during an instrument software upgrade. Both single and double quotes are supported for any filename parameter over SCPI.
Dependencies	Corrections are not supported by all Measurements. If in a Mode in which some Measurements support it, this key will be grayed out in measurements that do not. The key will not show at all if no measurements in the Mode support it. This key will not appear unless you have the proper option installed in your instrument.
Readback	Selected Correction
<b>Backwards Compatibility SCPI</b>	:MMEMory:STORe:CORRection ANTenna   CABLe   OTHer   USER, <filename> For backwards compatibility, ANTenna maps to 1, CABLe maps to 2, OTHer maps to 3 and USER maps to 4
Initial S/W Revision	A.02.00

## Correction Data File

A Corrections Data File contains a copy of one of the analyzer correction tables. Corrections provide a way to adjust the trace display for predetermined gain curves (such as for cable loss).

Corrections files are text files in .csv (comma separated values) form, to make them importable into Excel or other spreadsheet programs. The format for Corrections files is as follows.

Line #	Type of field	Example	Notes
1	File type, must be "Amplitude Correction"	Amplitude Correction	May not be omitted
2	File Description (in quotes)	"Correction Factors for 11966E"	60 characters max; may be empty but may not be omitted. If exceeds 60 characters, error -233 Too much data reported
3	Comment (in quotes)	"Class B Radiated"	60 characters max; may be empty but

Line #	Type of field	Example	Notes
			may not be omitted. . If exceeds 60 characters, error -233 Too much data reported
4	Instrument Version, Model #	A.02.06,N9020A	May be empty but may not be omitted
5	Option List, File Format Version	K03 LFE EXM ,01	May be empty but may not be omitted
6	Freq Unit to be used for all frequency values in the file	Frequency Unit,MHz	assumed to be Hz if omitted
7	Antenna Unit	Antenna Unit,None	If omitted leaves the Antenna unit unchanged. The amplitude unit in the Antenna Unit field is a conversion factor that is used to adjust the Y Axis Units of the current mode, if the mode supports Antenna Units. For more details on antenna correction data, refer to the Input/Output,Corrections key description. Allowable values: dBuV/m, dBuA/m, dBG, dBpT, None
8	Freq Interpolation	Frequency Interpolation,Linear	if omitted leaves the Freq Interpolation unchanged. Allowable values: Linear, Logarithmic
9	Bias value in mA	Bias,0.00	If omitted leaves the Bias value unchanged (added as of A.08.50)
10	Bias State	Bias State,On	If omitted leaves the Bias State unchanged. Allowable values: On, Off (added as of A.08.50)
11	Overlap, two values, Freq1 and Freq2, separated by commas.	Overlap,33500,40000	Uses Freq Unit from line 6. Thus, in this example Freq1=33.5 GHz, Freq2= 40.0 GHz (see note below). If omitted leaves the overlap unchanged (added as of A.08.50)
12	DATA marker	DATA	Corrections data begins in the next line

Lines 2 through 5 can be empty but must appear in the file. Lines 6 through 11 are optional, the lines can be left out of the file altogether.

The Overlap row and the two Bias rows apply only to external mixing. Both are read-only, they are never written by the analyzer. The only way to insert or modify these rows is to edit the file with a text editor or a spreadsheet editor. These rows are intended for use by mixer manufacturers, as they allow the manufacturer to insert data about how the mixer corrections were generated and how they should be applied. The Bias rows allow you to specify whether to turn Bias on or off when the Correction is turned on and to specify a Bias value (turning off the Correction does not change the Bias, but turning it back on again sets it to the value specified in the file). The Overlap row allows you to specify an overlap region in which

two different corrections may be applied. It is expected that in the corrections data itself, there will be TWO corrections values exactly at Max Freq, otherwise Overlap is ignored. The way the overlap is processed is as follows: if at any given time the current analyzer Start Freq is greater than Freq 1 and lower than Freq 2, and the current Stop Freq is greater than Freq 2, extend the first correction point at or above Freq 2 down to Freq 1, rather than using the correction data between Freq1 and Freq2.

The Antenna Unit row can only be used in Correction register 1, because there can only be one setting for Antenna Unit at any given time. If a Correction whose Antenna Unit is set to anything but None is loaded into any Correction register but 1, an error is generated (Mass storage error; Can only load an Antenna Unit into Correction 1). When a correction file is saved from any Correction register but 1, Antenna Unit is always written as None.

Similarly, the Bias rows can only be used in Correction register 1, because there can only be one setting for Bias at any given time. If a Correction file with a Bias or Bias State row is loaded into any Correction register but 1, an error is generated: Mass storage error; Can only load Bias Settings into Correction 1

The data follows the DATA row, as comma separated X, Y pairs; one pair per line.

For example, suppose you have an Antenna to correct for on an N9020A version A.02.06 and the correction data is:

- 0 dB at 200 MHz
- 17 dB at 210 MHz
- 14.8 dB at 225 MHz

Then the file will look like:

- Amplitude Correction
- "Correction Factors for 11966E"
- "Class B Radiated"
- A.02.06,N9020A
- P13 EA3 UK6,01
- Frequency Unit,MHz
- Antenna Unit,dBuV/m
- Frequency Interpolation,Linear
- DATA
- 200.000000,0.00
- 210.000000,17.00
- 225.000000,14.80

The choices for the 1 of N fields in the metadata are as follows:

- Frequency Unit: Hz, kHz, MHz, GHz
- Antenna Unit: dBuV/m, dBuA/m, dBG, dBpT, None

- Frequency Interpolation: Logarithmic, Linear

### Amplitude Correction

These keys let you choose which Correction to save. Once selected, the key returns back to the Export Data menu and the selected Correction number is annotated on the key.

The next step in the Save process is to select the Save As key in the Export Data menu.

Key Path	Save, Data, Amplitude Correction
Preset	Not part of a Preset, but is reset to Correction 1 by Restore Input/Output Defaults. Survives a shutdown.
Readback	1
Initial S/W Revision	A.02.00

### Trace

Pressing this key selects Trace as the data type to be exported. Pressing this key when it is already selected brings up the Trace Menu, which allows you to select which Trace to save.

Key Path	Save, Data
<b>Remote Command</b>	:MMEMory:STORe:DTRaces <filename>
<b>Example</b>	:MMEM:STOR:DTR "myPeak.csv" exports traces to the file myPeak.csv in the current path. The default path is My Documents\EMI\data\DANalyzer\traces
Notes	If the save is initiated via SCPI, and the file already exists, the file will be overwritten. Using the C: drive is strongly discouraged, since it runs the risk of being overwritten during an instrument software upgrade. Both single and double quotes are supported for any filename parameter over SCPI.
Dependencies	Traces cannot be recalled from a trace file that was saved with ALL traces selected.
Readback	selected Trace
Status Bits/OPC dependencies	Sequential - waits for previous measurement to complete
Initial S/W Revision	A.14.00

The trace file contains “meta” data which describes the current state of the analyzer.

The following file example shows the Trace file content in Excel.

AllTrace	
EMI:DANalyzer	
A.11.00_R0009	N9020A
526 EA3 B25 P26 PFR	



Frequency	150000
Attenuation	35
Y Axis Unit	dBuV
Ref Level Offset	0
Internal Preamp State	Off
Internal Preamp Band	Low
Resolution Bandwidth	120000
Measurement Time	0.0005
Duration (hh:mm:ss)	02:00:00

## Data

Trace	Peak	QuasiPeak
	23.7515958	20.173686
	24.6648769	20.194918
	23.3178199	20.213507
	23.5216423	20.221337
	23.4602343	20.220859
	23.5765176	20.212508
	23.7032533	20.197088
	24.825583	20.185434
	23.6549108	20.186032
	23.1558073	20.184001
	23.8378283	20.171481
	24.0481835	20.148553
	23.7659679	20.165786
	23.6379256	20.191835
	23.1793252	20.20728
	23.7241582	20.208026
	24.0573294	20.205218

## Disturbance List

Pressing this key selects Disturbance List as the data type to be exported with a save request. The next step is to select the Save As key in the Save Data menu.

Key Path	Save, Data
Remote Command	:MMEMory:STORe:DLIS <filename>
Example	MMEM:STOR:DLIS "DisturbanceList2.csv"

	exports the Disturbance List to the file myDisturbanceList2.csv in the default path.
Notes	The default path is at "My Documents\EMI\data\ DANalyzer \DisturbanceList\DisturbanceList_ xxx.csv" If the save is initiated via SCPI, and the file already exists, the file will be overwritten. Using the C: drive is strongly discouraged, since it runs the risk of being overwritten during an instrument software upgrade. Both single and double quotes are supported for any filename parameter over SCPI.
Initial S/W Revision	A.14.00

### Disturbance List File

A Disturbance List file contains a copy of the disturbance lists obtained during measurement. The first four lines are system required header lines, and must be in the correct order.

The data follows as comma separated values. A keyword "DATA" precedes the data. Below is an example of disturbance list file

```
DisturbanceList
EMI:DAN
A.11.05,N9020A
B1X P13 EA3 BBA B2X ERC UK6 BAB EMC K03 B25 503 P08 526 508 513 S40 P26 B1C HBA P03 PFR ,01
Y Axis Unit,DecibelMicrovolt
DATA
NO,DURATION,PEAK AMPTD,QP AMPTD,TYPE OF DISTURBANCE,TIMESTAMP,COMMENT
1,10.01,87.88, 78.88,CLICK,2011/11/11 11:11:1,
2,9.99,87.88, 78.88,CLICK,2011/11/11 11:11:1,
3,2089.98,87.88, 78.88,CONT DISTURBANCE,2011/11/11 11:11:1,UNDER INVESTIGATION
4,10.02,87.88, 78.88,CLICK,2011/11/11 11:11:1,
5,210.04,87.88, 78.88,CONT DISTURBANCE,2011/11/11 11:11:1,UNDER INVESTIGATION
```

### Disturbance Analyzer Meas Result

Pressing this key selects Meas Result as the data type to be exported. Pressing this key when it is already selected brings up the Meas Result Menu, which allows you to select and edit the contents of Meas Result to save.

Key Path	Save, Data
Remote Command	:MMEMory:STORe:RESults <filename>
Example	:MMEM:STOR:RES "report1.html" exports the measurement result to the file report1.html
Notes	The default path is at "My Documents\EMI\data\ DANalyzer \Results\report.html"

---

If the save is initiated via SCPI, and the file already exists, the file and the directory will be overwritten.

Using the C: drive is strongly discouraged, since it runs the risk of being overwritten during an instrument software upgrade.

Both single and double quotes are supported for any filename parameter over SCPI.

---

Initial S/W Revision	A.14.00
----------------------	---------

---

## Edit Header

This key is only available in the Disturbance Analyzer measurement. It enables you to edit the measurement results header information.

---

Key Path	Save, Export Data,
----------	--------------------

---

Initial S/W Revision	A.14.00
----------------------	---------

---

## Title

Provides a title of Meas Result file with a maximum length up to 100 characters. The descriptions will be stored in the exported Meas Result file as the title and can be displayed in the active function area by selecting them as the active function.

---

Key Path	Save, Export Data, Edit Header
----------	--------------------------------

---

<b>Remote Command</b>	:MMEMory:RESults:TITLe "string" :MMEMory:RESults:TITLe?
-----------------------	--

---

<b>Example</b>	:MMEM:RES:TITL "Advanced Company EMC Report"
----------------	--

---

Preset	"" (null String), not affected by Mode Preset, preset by Restore Mode Defaults.
--------	---

---

State Saved	Saved in instrument state
-------------	---------------------------

---

Initial S/W Revision	A.14.00
----------------------	---------

---

## Client

Provides the Client information with a maximum length up to 100 characters. The descriptions will be stored in the exported Meas Result file as the Client field and can be displayed in the active function area by selecting them as the active function.

---

Key Path	Save, Export Data, Edit Header
----------	--------------------------------

---

<b>Remote Command</b>	:MMEMory:RESults:CLient "string" :MMEMory:RESults:CLient?
-----------------------	--

---

<b>Example</b>	:MMEM:RES:CLI "XYZ Corp Limited"
----------------	----------------------------------

---

Preset	"" (null String), not affected by Mode Preset, preset by Restore Mode Defaults.
--------	---

---

State Saved	Saved in instrument state
-------------	---------------------------

---

Initial S/W Revision	A.14.00
----------------------	---------

---

### Operator

Provides the Operator information with a maximum length up to 100 characters. The descriptions will be stored in the exported Meas Setup file as the Operator field and can be displayed in the active function area by selecting them as the active function.

Key Path	Save, Export Data, Edit Header
Remote Command	:MMEMory:RESults:OPERator "string" :MMEMory:RESults:OPERator?
Example	:MMEM:RES:OPER "XYZ"
Preset	"" (null String), not affected by Mode Preset, preset by Restore Mode Defaults.
State Saved	Saved in instrument state
Initial S/W Revision	A.14.00

### Product Description

Provides the Product Description information with a maximum length up to 100 characters. The descriptions will be stored in the exported Meas Result file as the Product Description field and can be displayed in the active function area by selecting them as the active function.

Key Path	Save, Export Data, Edit Header
Remote Command	:MMEMory:RESults:PDEscription "string" :MMEMory:RESults:PDEscription?
Example	:MMEM:RES:PDES "Model ABC"
Preset	"" (null String), not affected by Mode Preset, preset by Restore Mode Defaults.
State Saved	Saved in instrument state
Initial S/W Revision	A.14.00

### Comment

Provides the ability to add a comment for the Meas Result file with a maximum length up to 1000 characters. The descriptions will be stored in the exported Meas Result file as the Product Description field and can be displayed in the active function area by selecting them as the active function.

Key Path	Save, Export Data, Edit Header
Remote Command	:MMEMory:RESults:COMMent "string" :MMEMory:RESults:COMMent?
Example	:MMEM:RES:COMM "Result is good"
Preset	"" (null String), not affected by Mode Preset, preset by Restore Mode Defaults.
State Saved	Saved in instrument state
Initial S/W Revision	A.14.00

## Meas Setup On/Off

Provides measurement setup information in the Meas Result file.

Key Path	Save, Export Data, Meas Result
<b>Remote Command</b>	:MMEMory:RESults:MSETup ON OFF 0 1 :MMEMory:RESults:MSETup?
<b>Example</b>	:MMEM:RES:MSET ON
Preset	Not part of Preset, but is reset to ON by Restore Mode Defaults; survives Shutdown.
State Saved	Saved in instrument state
Range	On Off
Initial S/W Revision	A.14.00

## Disturbance List On/Off

Provides Disturbance list data in the Meas Result file.

Key Path	Save, Export Data, Meas Result
<b>Remote Command</b>	:MMEMory:RESults:DLISt ON OFF 0 1 :MMEMory:RESults:DLISt?
<b>Example</b>	:MMEM:RES:DLISt ON
Preset	Not part of Preset, but is reset to ON by Restore Mode Defaults; survives Shutdown.
State Saved	Saved in instrument state
Range	On Off
Initial S/W Revision	A.14.00

## Trace (All Traces) On/Off

Provides Trace data in the Meas Result file.

Key Path	Save, Export Data, Meas Result
<b>Remote Command</b>	:MMEMory:RESults:TRACe ON OFF 0 1 :MMEMory:RESults:TRACe?
<b>Example</b>	:MMEM:RES:TRAC ON
Preset	Not part of Preset, but is reset to ON by Restore Mode Defaults; survives Shutdown.
State Saved	Saved in instrument state

Range	On Off
Initial S/W Revision	A.14.00

### Screen Image

Pressing Screen Image accesses a menu of functions that enable you to specify a format and location for the saved screen image. It brings up a menu that allows you to specify the color scheme of the Screen Image (Themes) or navigate to the Save As dialog to perform the actual save.

Screen Image files contain an exact representation of the analyzer display. They cannot be loaded back onto the analyzer, but they can be loaded into your PC for use in many popular applications.

The image to be saved is actually captured when the Save front panel key is pressed, and kept in temporary storage to be used if you ask for a Screen Image save. When the Screen Image key is pressed, a "thumbnail" of the captured image is displayed, as shown below:

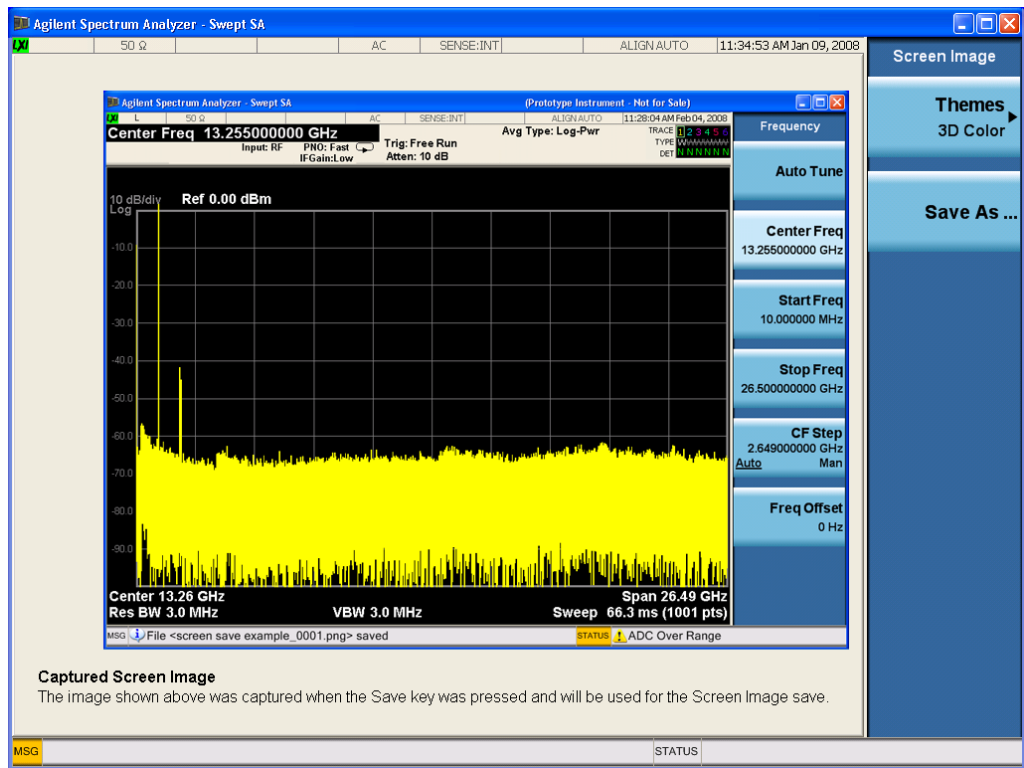

When you continue on into the Save As menu and complete the Screen Image save, the image depicted in the thumbnail is the one that gets saved, showing the menus that were on the screen before going into the Save menus. The save is performed immediately and does not wait until the measurement is complete.

After you have completed the save, the Quick Save front-panel key lets you quickly repeat the last save performed, using an auto-named file, with the current screen data.

**NOTE**

For versions previous to A.01.55, if you initiate a screen image save by navigating through the Save menus, the image that is saved will contain the Save menu softkeys, not the menus and the active function that were on the screen when you first pressed the Save front panel key.

Key Path	Save
Mode	All
<b>Remote Command</b>	:MMEMory:STORe:SCReen <filename>
<b>Example</b>	:MMEM:STOR:SCR "myScreen.png" This stores the current screen image in the file MyScreenFile.png in the default directory.
Initial S/W Revision	Prior to A.02.00

## Themes

Accesses a menu of functions that enable you to choose the theme to be used when saving the screen image.

The **Themes** option is the same as the **Themes** option under the **Display** and **Page Setup** dialogs. It allows you to choose between themes to be used when saving the screen image.

Key Path	Save, Screen Image
<b>Remote Command</b>	:MMEMory:STORe:SCReen:THEMe TDColor   TDMonochrome   FColor   FMONochrome  :MMEMory:STORe:SCReen:THEMe?
<b>Example</b>	:MMEM:STOR:SCR:THEM TDM
Preset	3D Color; Is not part of Preset, but is reset by Restore Misc Defaults or Restore System Defaults All and survives subsequent running of the modes.
Readback	3D Color   3D Mono   Flat Color   Flat Mono
Backwards Compatibility Notes	In ESA and PSA we offer the choice of "Reverse Bitmap" or "Reverse Metafile" when saving screen images. This is much like the "Flat Color" theme available in X-Series. Also, if you selected Reverse Bitmap AND a black & white screen image, that would be much like "Flat Monochrome". In other words, each of the X-Series themes has a similar screen image type in ESA/PSA. But they are not identical.
Initial S/W Revision	Prior to A.02.00

## 3D Color

Selects a standard color theme with each object filled, shaded and colored as designed.

Key Path	Save, Screen Image, Themes
<b>Example</b>	MMEM:STOR:SCR:THEM TDC
Readback	3D Color
Initial S/W Revision	Prior to A.02.00

### 3D Monochrome

Selects a format that is like 3D color but shades of gray are used instead of colors.

Key Path	Save, Screen Image, Themes
<b>Example</b>	MMEM:STOR:SCR:THEM TDM
Readback	3D Mono
Initial S/W Revision	Prior to A.02.00

### Flat Color

Selects a format that is best when the screen is to be printed on an ink printer.

Key Path	Save, Screen Image, Themes
<b>Example</b>	MMEM:STOR:SCR:THEM FCOL
Readback	Flat Color
Initial S/W Revision	Prior to A.02.00

### Flat Monochrome

Selects a format that is like Flat Color. But only black is used (no colors, not even gray), and no fill.

Key Path	Save, Screen Image, Themes
<b>Example</b>	MMEM:STOR:SCR:THEM FMON
Readback	Flat Mono
Initial S/W Revision	Prior to A.02.00

### Save As...

When you press "Save As", the analyzer brings up a Windows dialog and a menu entitled "**Save As.**" This menu allows you to navigate to the various fields in the Windows dialog without using a keyboard or mouse. The Tab and Arrow keys can also be used for dialog navigation.

See "[To File . . .](#)" on page 1096 in Save, State for a full description of this dialog and menu.

The default path for Screen Images is

My Documents\`<mode name>`\screen.

where `<mode name>` is the parameter used to select the mode with the INST:SEL command (for example, SA for the Spectrum Analyzer).

Key Path	Save, Screen Image
Notes	Brings up Save As dialog for saving a Screen Image Save Type
Initial S/W Revision	Prior to A.02.00



## Mass Storage Catalog (Remote Command Only)

Key path	SCPI Only
<b>Remote Command</b>	:MMEMory:CATalog? [<directory_name>]
Notes	<p>The string must be a valid logical path.</p> <p>Queries disk usage information (drive capacity, free space available) and obtains a list of files and directories in a specified directory in the following format:</p> <p>&lt;numeric_value&gt;,&lt;numeric_value&gt;,{&lt;file_entry&gt;}</p> <p>It returns two numeric parameters and as many strings as there are files and directories. The first parameter indicates the total amount of storage currently used in bytes. The second parameter indicates the total amount of storage available, also in bytes. The &lt;file_entry&gt; is a string. Each &lt;file_entry&gt; indicates the name, type, and size of one file in the directory list:</p> <p>&lt;file_name&gt;,&lt;file_type&gt;,&lt;file_size&gt;</p> <p>As the windows file system has an extension that indicates file type, &lt;file_type&gt; is always empty. &lt;file_size&gt; provides the size of the file in bytes. For directories, &lt;file_entry&gt; is surrounded by square brackets and both &lt;file_type&gt; and &lt;file_size&gt; are empty</p>
Initial S/W Revision	Prior to A.02.00

## Mass Storage Change Directory (Remote Command Only)

Key path	SCPI Only
<b>Remote Command</b>	:MMEMory:CDIRectory [<directory_name>] :MMEMory:CDIRectory?
Notes	<p>The string must be a valid logical path.</p> <p>Changes the default directory for a mass memory file system. The &lt;directory_name&gt; parameter is a string. If no parameter is specified, the directory is set to the *RST value.</p> <p>At *RST, this value is set to the default user data storage area, that is defined as System.Environment.SpecialFolder.Personal.</p> <p>Query returns full path of the default directory.</p>
Initial S/W Revision	Prior to A.02.00

## Mass Storage Copy (Remote Command Only)

Key path	SCPI Only
<b>Remote Command</b>	:MMEMory:COPY <string>,<string>[,<string>,<string>]
Notes	<p>The string must be a valid logical path.</p> <p>Copies an existing file to a new file or an existing directory to a new directory.</p> <p>Two forms of parameters are allowed. The first form has two parameters. In this form, the first parameter specifies the source, and the second parameter specifies the destination.</p>

---

The second form has four parameters. In this form, the first and third parameters specify the source. The second and fourth parameters specify the directories. The first pair of parameters specifies the source. The second pair specifies the destination. An error is generated if the source doesn't exist or the destination file already exists.

This command will generate an "access denied" error if the destination is a restricted folder (e.g., C:\Windows) and the current user does not have Power User or Administrator privileges.

---

## Mass Storage Device Copy (Remote Command Only)

This command transfers data to/from a file and a peripheral device.

---

Key path	SCPI Only
<b>Remote Command</b>	:MMEMory:COpy:DEvice <source_string>,<dest_string>
Notes	The strings must be a valid logical path or a valid device keyword. If the dest_string is a device keyword, the data is copied from the source file to the device. If the source_string is a device keyword, the data is copied to the source file from the device.  Valid device keywords are: SNS (smart noise source)  An error is generated if the file or device is not found.

---

## Mass Storage Delete (Remote Command Only)

---

Key path	SCPI Only
<b>Remote Command</b>	:MMEMory:DELeTe <file_name>[,<directory_name>]
Notes	The string must be a valid logical path.  Removes a file from the specified directory. The <file_name> parameter specifies the file name to be removed. This command will generate an "access denied" error if the file is in a restricted folder (e.g., C:\Windows) and the current user does not have Power User or Administrator privileges.
Initial S/W Revision	Prior to A.02.00

---

## Mass Storage Data (Remote Command Only)

Creates a file containing the specified data OR queries the data from an existing file.

---

Key path	SCPI Only
<b>Remote Command</b>	:MMEMory:DATA <file_name>,<data> :MMEMory:DATA? <file_name>
Notes	The string must be a valid logical path.  The command form is MMEMory:DATA <file_name>,<data>. It loads <data> into the file <file_name>. <data> is in 488.2 block format. <file_name> is string data.  The query form is MMEMory:DATA? <file_name> with the response being the associated <data> in

---

	block format.
Initial S/W Revision	Prior to A.02.00

### Mass Storage Make Directory (Remote Command Only)

Key path	SCPI Only
<b>Remote Command</b>	:MMEMory:MDIRectory <directory_name>
Notes	<p>The string must be a valid logical path.</p> <p>Creates a new directory. The &lt;directory_name&gt; parameter specifies the name to be created.</p> <p>This command will generate an “access denied” error if the new directory would be in a restricted folder (e.g., C:\Windows) and the current user does not have Power User or Administrator privileges.</p>
Initial S/W Revision	Prior to A.02.00

### Mass Storage Move (Remote Command Only)

Key path	SCPI Only
<b>Remote Command</b>	:MMEMory:MOVE <string>, <string> [, <string>, <string>]
Notes	<p>The string must be a valid logical path.</p> <p>Moves an existing file to a new file or an existing directory to a new directory.</p> <p>Two forms of parameters are allowed. The first form has two parameters. In this form, the first parameter specifies the source, and the second parameter specifies the destination.</p> <p>The second form has four parameters. In this form, the first and third parameters specify the source. The second and fourth parameters specify the directories. The first pair of parameters specifies the source. The second pair specifies the destination. An error is generated if the source doesn't exist or the destination file already exists.</p> <p>This command will generate an “access denied” error if the destination is a restricted folder (e.g., C:\Windows) and the current user does not have Power User or Administrator privileges.</p>
Initial S/W Revision	Prior to A.02.00

### Mass Storage Remove Directory (Remote Command Only)

Key path	SCPI Only
<b>Remote Command</b>	:MMEMory:RDIRectory <directory_name>
Notes	<p>The string must be a valid logical path.</p> <p>Removes a directory. The &lt;directory_name&gt; parameter specifies the directory name to be removed. All files and directories under the specified directory shall also be removed.</p> <p>This command will generate an “access denied” error if the folder is a restricted folder (e.g., C:\Windows) or is in a restricted folder and the current user does not have Power User or Administrator privileges.</p>
Initial S/W Revision	Prior to A.02.00

12 Disturbance Analyzer Measurement  
Save

## Single

In Single Mode, The Disturbance Analyzer measurement will stop after the specified measurement duration time is complete .

---

Key Path	Front-panel key
Initial S/W Revision	A.14.00

---

See "[Source](#)" on page 1118 for more information.

---

Key Path	Front-panel key
----------	-----------------

---

## Source

There is no Source control functionality for this measurement. When this key is pressed, the screen either displays a blank menu, or the previously-selected menu remains unchanged.

---

Key Path	Front-panel key
----------	-----------------

---

## SPAN X Scale

Displays the menu keys that enable you to control the span x scale parameters.

Key Path	Front-panel key
Notes	Front panel only.
Initial S/W Revision	A.14.00

### Ref Value

Specifies the Ref Value of the graph used to configure the X-axis display range.

Key Path	SPAN X Scale
<b>Remote Command</b>	:DISPlay:DANalyzer:VIEW[1]:WINDow[1]:TRACe:X[:SCALE]:RLEVel <time> :DISPlay:DANalyzer:VIEW[1]:WINDow[1]:TRACe:X[:SCALE]:RLEVel?
<b>Example</b>	DISP:DAN:VIEW:WIND:TRAC:X:RLEV 100 s DISP:DAN:VIEW:WIND:TRAC:X:RLEV?
Couplings	No
Preset	0 s
State Saved	Saved in instrument state
Min	0 s
Max	7199.8 s
Initial S/W Revision	A.14.00

### Scale/Div

Specifies the Scale/Div value of the graph used to configure the X-axis display range.

Key Path	SPAN X Scale
<b>Remote Command</b>	:DISPlay:DANalyzer:VIEW[1]:WINDow[1]:TRACe:X[:SCALE]:PDIVision <time> :DISPlay:DANalyzer:VIEW[1]:WINDow[1]:TRACe:X[:SCALE]:PDIVision?
<b>Example</b>	DISP:DAN:VIEW:WIND:TRAC:X:PDIV 1s DISP:DAN:VIEW:WIND:TRAC:X:PDIV?
Preset	1 s
State Saved	Saved in instrument state
Min	20 ms
Max	720 s
Initial S/W Revision	A.14.00

## Full Scale

Shows the data of all traces on the screen by setting the Ref Value to 0s and Scale/Div to Max value. The maximum value of Scale/Div is dependent on the Duration value.

Key Path	SPAN X Scale
Remote Command	:DISPlay:DANalyzer:VIEW[1]:WINDow[1]:TRACe:X[:SCALe]:FULL
Example	DISP:DAN:VIEW:WIND:TRAC:X:FULL
Initial S/W Revision	A.14.00



## Sweep Control

Displays a menu of keys that enable you to control the sweep parameters.

Key Path	Front-panel key
Notes	Front panel only.
Initial S/W Revision	A.14.00

### Pause / Resume

Allows you to pause and resume a measurement. When a measurement is paused, the label of the key changes to Resume. Press Resume to resume the measurement.

Key Path	Sweep/ Control
<b>Remote Command</b>	INITiate:PAUSE
<b>Example</b>	INIT:PAUS
Couplings	When the measurement is paused, the label on the key changes to “Resume”
Initial S/W Revision	A.14.00

Key Path	Sweep/ Control
<b>Remote Command</b>	:INITiate:RESume
<b>Example</b>	INIT:RES
Couplings	When the measurement is resumed, the label on the key changes to “Pause”
Initial S/W Revision	A.12.00

### Stop / Start

Allows you to start and stop the measurement. When the measurement is started, the label of the key changes to Stop. Press the Start or Restart key to start to run the measurement.

When you start a new measurement, it will delete the disturbance list if the disturbance has any data. When pressing Start or Restart, if the disturbance list has data, an advisory message will issue a warning.

Key Path	Sweep/ Control
<b>Remote Command</b>	:INITiate:ABORt
<b>Example</b>	INIT:ABOR
Initial S/W Revision	A.14.00
Coupling	When the measurement is stopped, the label on the key changes to “Pause”.

Key Path	Sweep/ Control
Remote Command	:INITiate:IMMediate :INITiate:REStart
Example	INIT:IMM INIT:REST
Initial S/W Revision	A.14.00

## Start Analysis

Executes the disturbance analysis process and the measurement results will be shown after completion.

Key Path	Sweep/ Control
Remote Command	:INITiate:DANalyzer:SANalysis
Example	INIT:DAN:SAN
Dependencies	This key is grayed out when a measurement is running. If the grayed out key is pressed, an advisory message is generated. If the equivalent SCPI command is sent, this same message is generated as part of a “-221, Settings conflict” warning.
Initial S/W Revision	A.12.00

## System

See "System" on page 272

## Trace/Detector

There is no Trace/Detector functionality in Disturbance Analyzer measurement.

---

Key Path

Front-panel key

---

## Trigger

See [\\_\\_\\_](#) on page X

## User Preset

Accesses a menu that gives you the following three choices:

- User Preset – recalls a state previously saved using the Save User Preset function.
- User Preset All Modes – presets all of the modes in the analyzer
- Save User Preset– saves the current state for the current mode

Key Path	Front-panel key
Backwards Compatibility Notes	<p>User Preset is actually loading a state, and in legacy analyzers, it was possible to load a state without affecting the trace data, limit lines or correction data. Similarly it was possible to do a User Preset without affecting the trace data, limit lines or correction data.</p> <p>In the X-Series, “state” always includes all of this data; so whenever state is loaded, or User Preset is executed, all of the traces, limit lines and corrections are affected. Although this differs from previous behavior, it is desirable behavior, and should not cause adverse issues for users.</p> <p>On ESA and PSA, User Preset affected the entire instrument’s state. In the X-Series, User Preset only recalls the state for the active mode. There is a User Preset file for each mode. User Preset can never cause a mode switch as it can in legacy analyzers. If you want to recall all modes to their user preset file state, you will need to do a User Preset after mode switching into each mode.</p> <p>User Preset recalls mode state which can now include data like traces; whereas on ESA and PSA, User Preset did not affect data.</p>
Initial S/W Revision	Prior to A.02.00

## User Preset

User Preset sets the state of the currently active mode back to the state that was previously saved for this mode using the Save User Preset menu key or the SCPI command, SYST:PRES:USER:SAV. It not only recalls the Mode Preset settings, but it also recalls all of the mode persistent settings, and the Input/Output system setting that existed at the time Save User Preset was executed.

If a Save User Preset has not been done at any time, User Preset recalls the default user preset file for the currently active mode. The default user preset files are created if, at power-on, a mode detects there is no user preset file. There will never be a scenario when there is no user preset file to restore. For each mode, the default user preset state is the same state that would be saved if a Save User Preset is performed in each mode right after doing a Restore Mode Default and after a Restore Input/Output Defaults.

The User Preset function does the following:

- Aborts the currently running measurement.
- Sets the mode State to the values defined by Save User Preset.
- Makes the saved measurement for the currently running mode the active measurement.
- Brings up the saved menu for the power-on mode.
- Clears the input and output buffers.
- Sets the Status Byte to 0.

Key Path	User Preset
<b>Remote Command</b>	:SYSTem:PRESet:USER
<b>Example</b>	:SYST:PRES:USER:SAVE:SYST:PRES:USER
Notes	:SYST:PRES:USER:SAVE is used to save the current state as the user preset state. Clears all pending OPC bits. The Status Byte is set to 0. Pressing the User Preset front-panel key while already in the User Preset menu will cause the User Preset to get executed
Couplings	A user preset will cause the currently running measurement to be aborted and cause the saved measurement to be active. Recalling a User Preset file has the same issues that recalling a Save State file has. Some settings may need to be limited and therefore re-coupled, since the capabilities of the mode may have changes when the User Preset file was last saved.
Initial S/W Revision	Prior to A.02.00

## User Preset All Modes

Recalls all of the User Preset files for each mode, switches to the power-on mode, and activates the saved measurement from the power-on mode User Preset file.

### NOTE

When the instrument is secured, all of the user preset files are converted back to their default user preset files.

The User Preset function does the following:

- Aborts the currently running measurement.
- Switches the Mode to the power-on mode.
- Restores the User Preset files for each mode.
- Makes the saved measurement for the power-on mode the active measurement.
- Brings up the saved menu for the power-on mode.
- Clears the input and output buffers.
- Sets the Status Byte to 0.

Key Path	User Preset
<b>Remote Command</b>	:SYSTem:PRESet:USER:ALL
<b>Example</b>	:SYST:PRES:USER:SAVE:SYST:PRES:USER:ALL
Notes	Clears all pending OPC bits. The Status Byte is set to 0. :SYST:PRES:USER:SAVE is used to save the current state as the user preset state.
Couplings	A user preset will cause the currently running measurement to be aborted, cause a mode switch to the power-on mode, and cause the saved measurement to be active in the power-on mode. Recalling a User Preset file has the same issues that recalling a Save State file has. Some settings may need to be limited and therefore re-coupled, since the capabilities of the mode may have changes when the User Preset file was last saved.
Initial S/W Revision	Prior to A.02.00

## Save User Preset

Saves the currently active mode and its State. You can recall this User Preset file by pressing the User Preset menu key or sending the SYST:PRES:USER remote command. This same state is also saved by the Save State function.

Key Path	User Preset
Remote Command	:SYSTem:PRESet:USER:SAVE
Example	:SYST:PRES:USER:SAVE
Notes	:SYST:PRES:SAVE creates the same file as if the user requested a *SAV or a MMEM:STOR:STAT, except User Preset Save does not allow the user to specify the filename or the location of the file.
Initial S/W Revision	Prior to A.02.00



## View/Display

The View/Display key opens the Display Menu (common to most measurements) and the View menu for the current measurement.

Some measurements have simple View menus, or even no View menu, others provide many different Views.

Views are different ways of looking at data, usually different ways of looking at the same data, often when the data represents a time record that is being digitally processed with an FFT and/or other digital signal processing algorithms.

Key Path	Front-panel key
Initial S/W Revision	Prior to A.02.00

## Display

The Display menu is common to most measurements, and is used for configuring items on the display. Some Display menu settings apply to all the measurements in a mode, and some only to the current measurement. Those under the System Display Settings key apply to all measurements in all modes.

Key Path	Display
Key Path	View/Display
Initial S/W Revision	Prior to A.02.00

## Annotation

Turns on and off various parts of the display annotation. The annotation is divided up into four categories:

1. Meas Bar: This is the measurement bar at the top of the screen. It does not include the settings panel or the Active Function. Turning off the Meas Bar turns off the settings panel and the Active Function. When the Meas Bar is off, the graticule area expands to fill the area formerly occupied by the Meas Bar.
2. Screen Annotation: this is the annotation and annunciation around the graticule, including any annotation on lines (such as the display line, the threshold line, etc.) This does NOT include the marker number or the N dB result. When off, the graticule expands to fill the entire graticule area.
3. Trace annotation: these are the labels on the traces, showing their detector (or their math mode).
4. Active Function annotation: this is the active function display in the meas bar, and all of the active function values displayed on softkeys.

See the figure below. Each type of annotation can be turned on and off individually.

12 Disturbance Analyzer Measurement  
View/Display

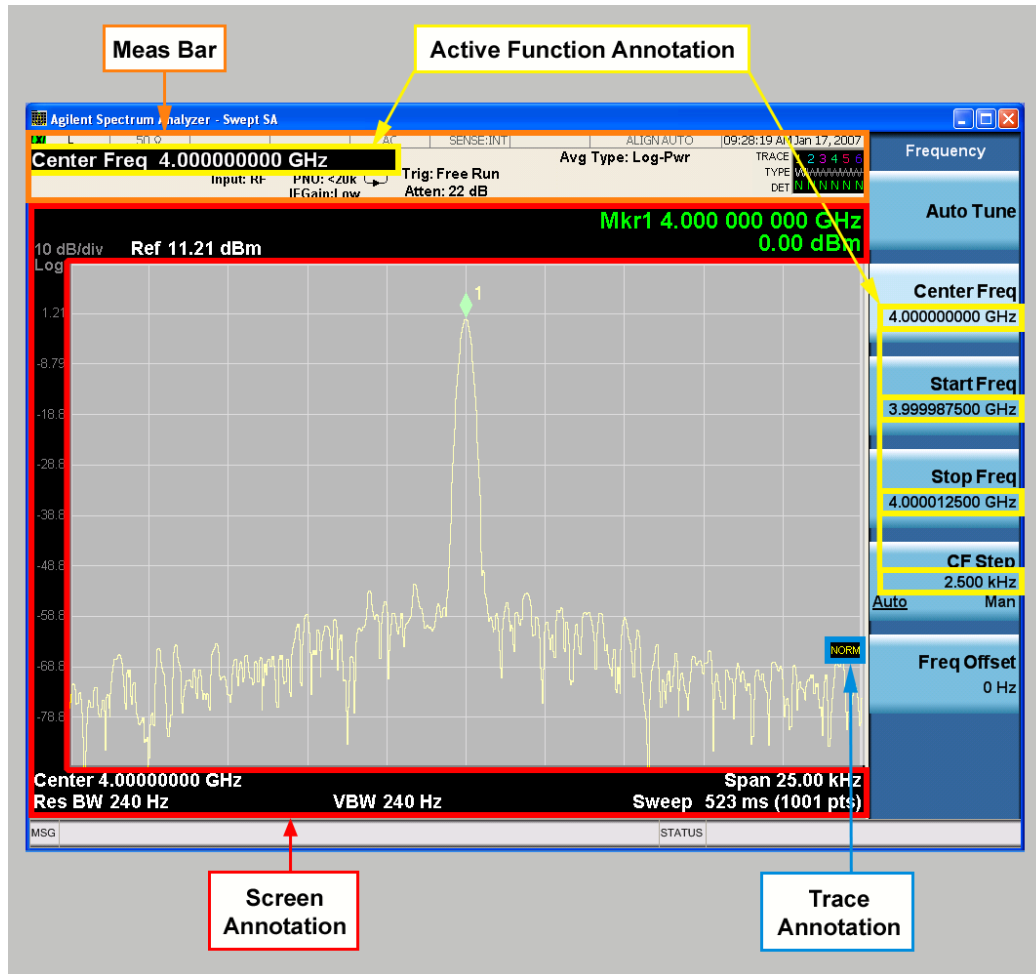

Key Path	View/Display, Display
Initial S/W Revision	Prior to A.02.00

Meas Bar On/Off

This function turns the Measurement Bar on and off, including the settings panel. When off, the graticule area expands to fill the area formerly occupied by the Measurement Bar.

Key Path	View/Display, Display, Annotation
Remote Command	:DISPlay:ANNOtation:MBAR[:STATe] OFF ON 0 1 :DISPlay:ANNOtation:MBAR[:STATe]?
Example	DISP:ANN:MBAR OFF
Dependencies	Grayed out and forced to OFF when System Display Settings, Annotation is set to Off.
Preset	On This should remain Off through a Preset when System DisplaySettings, Annotation is set to Off.
State Saved	Saved in instrument state.
Initial S/W Revision	Prior to A.02.00

## Screen

This controls the display of the annunciation and annotation around the graticule, including any annotation on lines (such as the display line, the threshold line, etc.) and the y-axis annotation. This does NOT include marker annotation (or the N dB result). When off, the graticule expands to fill the entire graticule area, leaving only the 1.5% gap above the graticule as described in the Trace/Detector chapter.

Key Path	View/Display, Display, Annotation
<b>Remote Command</b>	:DISPlay:ANNotation:SCReen[:STATe] OFF ON 0 1 :DISPlay:ANNotation:SCReen[:STATe]?
<b>Example</b>	DISP:ANN:SCR OFF
Dependencies	Grayed-out and forced to OFF when System Display Settings, Annotation is set to Off.
Preset	On This should remain Off through a Preset when System DisplaySettings, Annotation is set to Off
State Saved	Saved in instrument state.
Initial S/W Revision	Prior to A.02.00

## Trace

Turns on and off the labels on the traces, showing their detector (or their math mode) as described in the Trace/Detector section.

If trace math is being performed with a trace, then the trace math annotation will replace the detector annotation.

Key Path	View/Display, Display, Annotation
<b>Remote Command</b>	:DISPlay:ANNotation:TRACe[:STATe] ON OFF 1 0 :DISPlay:ANNotation:TRACe[:STATe]?
<b>Example</b>	DISP:ANN:TRAC OFF
Preset	Off
State Saved	Saved in instrument state.
Initial S/W Revision	Prior to A.02.00

## Active Function Values On/Off

Turns on and off the active function display in the Meas Bar, and all of the active function values displayed on the softkeys.

Note that all of the softkeys that have active functions have these numeric values blanked when this function is on. This is a security feature..

12 Disturbance Analyzer Measurement  
View/Display

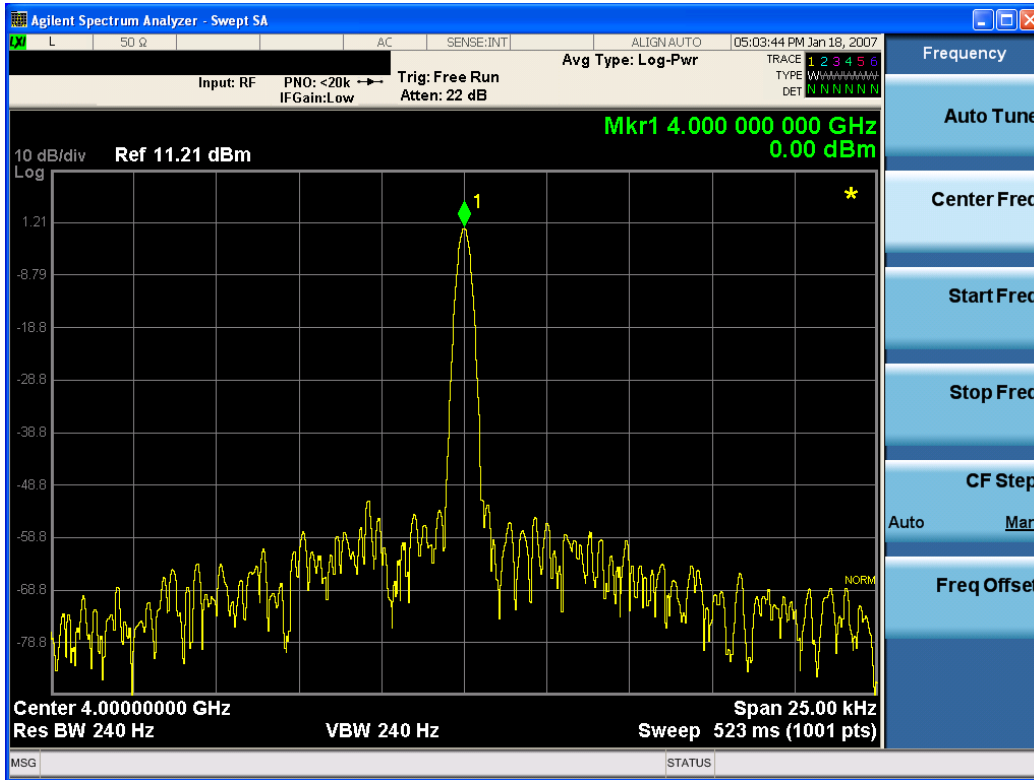

Key Path	View/Display, Display, Annotation
Remote Command	:DISPlay:ACTivefunc[:STATE] ON OFF 1 0 :DISPlay:ACTivefunc[:STATE]?
Example	DISP:ACT OFF
Dependencies	Grayed out and forced to OFF when System Display Settings, Annotation is set to Off.
Preset	On This should remain Off through a Preset when System DisplaySettings, Annotation is set to Off
State Saved	Saved in instrument state.
Initial S/W Revision	Prior to A.02.00

Title

Displays menu keys that enable you to change or clear a title on your display.

Key Path	View/Display, Display
Initial S/W Revision	Prior to A.02.00

Change Title

Writes a title into the "measurement name" field in the banner, for example, "Swept SA".

Press Change Title to enter a new title through the alpha editor. Press Enter or Return to complete the entry. Press ESC to cancel the entry and preserve your existing title.

The display title will replace the measurement name. It remains for this measurement until you press Change Title again, or you recall a state, or a Preset is performed. A title can also be cleared by pressing Title, Clear Title.

**NOTE**

Notice the inclusion of the <measurement> parameter in the command below. Because each measurement remembers the Display Title, the command must be qualified with the measurement name. For the Swept SA measurement this is not the case; no <measurement> parameter is used when changing the Display Title for the Swept SA measurement.

Key Path	View/Display, Display, Title
Mode	All
<b>Remote Command</b>	:DISPlay:<measurement>:ANNotation:TITLe:DATA <string> :DISPlay:<measurement>:ANNotation:TITLe:DATA?
<b>Example</b>	DISP:ANN:TITL:DATA "This Is My Title" This example is for the Swept SA measurement in the Spectrum Analyzer mode. The SANalyzer <measurement> name is not used. DISP:ACP:ANN:TITL:DATA "This Is My Title" This example is for Measurements other than Swept SA. Both set the title to: This Is My Title
Notes	Pressing this key cancels any active function. When a title is edited the previous title remains intact (it is not cleared) and the cursor goes at the end so that characters can be added or BKSP can be used to go back over previous characters.
Preset	No title (measurement name instead)
State Saved	Saved in instrument state.
Initial S/W Revision	Prior to A.02.00

### Clear Title

Clears a title from the front-panel display. Once cleared, the title cannot be retrieved. After the title is cleared, the current Measurement Name replaces it in the title bar.

Key Path	View/Display, Display, Title
<b>Example</b>	The following commands clear the title and restore the measurement's original title: DISP:ANN:TITL:DATA "" This example is for the Swept SA measurement in the Spectrum Analyzer mode. The SANalyzer <measurement> name is not used. DISP:ACP:ANN:TITL:DATA "" This example is for ACP; in measurements other than Swept SA the measurement name is required.
Notes	Uses the :DISPlay:<measurement>:ANNotation:TITLe:DATA <string> command with an empty string (in the Swept SA, the <measurement> is omitted).
Preset	Performed on Preset.
Initial S/W Revision	Prior to A.02.00

## Graticule

Pressing Graticule turns the display graticule On or Off. It also turns the graticule y-axis annotation on and off.

Key Path	View/Display, Display
Remote Command	:DISPlay:WINDow[1]:TRACe:GRATicule:GRID[:STATe] OFF ON 0 1 :DISPlay:WINDow[1]:TRACe:GRATicule:GRID[:STATe]?
Example	DISP:WIND:TRAC:GRAT:GRID OFF
Notes	The graticule is the set of horizontal and vertical lines that make up the grid/divisions for the x-axis and y-axis.
Preset	On
State Saved	Saved in instrument state
Initial S/W Revision	Prior to A.02.00

## System Display Settings

These settings are "Mode Global" – they affect all modes and measurements and are reset only by Restore Misc Defaults or Restore System Defaults under System.

Key Path	View/Display, Display
Initial S/W Revision	Prior to A.02.00

## Annotation Local Settings

This is a Mode Global override of the meas local annotation settings. When it is All Off, it forces ScreenAnnotation, Meas Bar, Trace, and Active Function Values settings to be OFF for all measurements in all modes. This provides the security based "annotation off" function of previous analyzers; hence it uses the legacy SCPI command.

When it is All Off, the Screen, Meas Bar, Trace, and Active Function Values keys under the Display, Annotation menu are grayed out and forced to Off. When Local Settings is selected, you are able to set the local annotation settings on a measurement by measurement basis.

Key Path	View/Display, Display, System Display Settings
Remote Command	:DISPlay:WINDow[1]:ANNotation[:ALL] OFF ON 0 1 :DISPlay:WINDow[1]:ANNotation[:ALL]?
Example	:DISP:WIND:ANN OFF
Preset	On (Set by Restore Misc Defaults)
State Saved	Not saved in instrument state.
Backwards Compatibility Notes	The WINDow parameter and optional subopcode is included for backwards compatibility but ignored – all windows are equally affected.
Initial S/W Revision	Prior to A.02.00

## Themes

Accesses a menu of functions that enable you to choose the theme to be used when saving the screen image.

The **Themes** option is the same as the **Themes** option under the **Display** and **Page Setup** dialogs. It allows you to choose between themes to be used when saving the screen image.

<b>Key Path</b>	Save, Screen Image
<b>Remote Command</b>	:MMEMory:STORe:SCReem:THEMe TDColor   TDMonochrome   FCOLor   FMONochrome  :MMEMory:STORe:SCReem:THEMe?
<b>Example</b>	:MMEM:STOR:SCR:THEM TDM
<b>Preset</b>	3D Color; Is not part of Preset, but is reset by Restore Misc Defaults or Restore System Defaults All and survives subsequent running of the modes.
<b>Readback</b>	3D Color   3D Mono   Flat Color   Flat Mono
<b>Backwards Compatibility Notes</b>	In ESA and PSA we offer the choice of "Reverse Bitmap" or "Reverse Metafile" when saving screen images. This is much like the "Flat Color" theme available in X-Series. Also, if you selected Reverse Bitmap AND a black & white screen image, that would be much like "Flat Monochrome". In other words, each of the X-Series themes has a similar screen image type in ESA/PSA. But they are not identical.
<b>Initial S/W Revision</b>	Prior to A.02.00

### 3D Color

Selects a standard color theme with each object filled, shaded and colored as designed.

<b>Key Path</b>	Save, Screen Image, Themes
<b>Example</b>	MMEM:STOR:SCR:THEM TDC
<b>Readback</b>	3D Color
<b>Initial S/W Revision</b>	Prior to A.02.00

### 3D Monochrome

Selects a format that is like 3D color but shades of gray are used instead of colors.

<b>Key Path</b>	Save, Screen Image, Themes
<b>Example</b>	MMEM:STOR:SCR:THEM TDM
<b>Readback</b>	3D Mono
<b>Initial S/W Revision</b>	Prior to A.02.00

### Flat Color

Selects a format that is best when the screen is to be printed on an ink printer.

Key Path	Save, Screen Image, Themes
<b>Example</b>	MMEM:STOR:SCR:THEM FCOL
Readback	Flat Color
Initial S/W Revision	Prior to A.02.00

### Flat Monochrome

Selects a format that is like Flat Color. But only black is used (no colors, not even gray), and no fill.

Key Path	Save, Screen Image, Themes
<b>Example</b>	MMEM:STOR:SCR:THEM FMON
Readback	Flat Mono
Initial S/W Revision	Prior to A.02.00

### Backlight

Accesses the display backlight on/off keys. This setting may interact with settings under the Windows "Power" menu.

When the backlight is off, pressing ESC, TAB, SPACE, ENTER, UP, DOWN, LEFT, RIGHT, DEL, BKSP, CTRL, or ALT turns the backlight on without affecting the application. Pressing any other key will turn backlight on and could potentially perform the action as well.

Key Path	View/Display, Display, System Display Settings
<b>Remote Command</b>	:DISPlay:BACKlight ON OFF :DISPlay:BACKlight?
Preset	ON (Set by Restore Misc Defaults)
Initial S/W Revision	Prior to A.02.00

### Backlight Intensity

An active function used to set the backlight intensity. It goes from 0 to 100 where 100 is full on and 0 is off. This value is independent of the values set under the Backlight on/off key.

Key Path	View/Display, Display, System Display Settings
<b>Remote Command</b>	:DISPlay:BACKlight:INTensity <integer> :DISPlay:BACKlight:INTensity?
<b>Example</b>	DISP:BACK:INT 50



Preset	100 (Set by Restore Misc Defaults)
Min	0
Max	100
Initial S/W Revision	Prior to A.02.00

## Normal

Selects the normal measurement view.

Key Path	View/ Display
<b>Example</b>	DISP:DAN:VIEW NORM
Initial S/W Revision	A.14.00

## Meas Results

Selects the Meas Result view.

Key Path	View/ Display
<b>Example</b>	DISP:DAN:VIEW MRES
Initial S/W Revision	A.14.00

## Disturbance Indicator Line

When on, a vertical white line will indicate the location of a disturbance on graph that corresponds to the selected disturbance in the disturbance list.

Key Path	View/ Display
<b>Remote Command</b>	:DISPlay:DANalyzer:VIEW:DISTurbanCe:ILINe ON OFF 1 0 :DISPlay:DANalyzer:VIEW:DISTurbanCe:ILINe?
<b>Example</b>	:DISP:DAN:VIEW:DIST:ILIN 1 :DISP:DAN:VIEW:DIST:ILIN?
Dependencies	The Disturbance Indicator Line will only be shown when the measurement is not running.
Preset	ON
State Saved	Saved in instrument state
Initial S/W Revision	A.14.00

